

ITT Cannon Trident Connectors: Trident Ringlock, Trident Neptune & TNM



INTERMATEABLE WITH SOURIAU CONNECTORS

ITT Cannon Trident connectors are a family of cost-effective, reliable circular connectors that include the Trident Ringlock, Trident Neptune and TNM series. All three series of ITT Cannon Trident connectors are fully-sealed to IP67. The Trident Ringlock and Trident Neptune series are UL94-V0 circular plastic connectors with a metal coupling nut and bayonet retention mechanisms, providing the cost and weight benefits of a plastic connector with the durability of a metal connector. Trident Ringlock connectors are intermateable with SOURIAU/Burndy Trim-Trio (UTG). Trident Neptune uses the same contacts as Ringlock, but is a unique product perfect as a transportation connector or in harsh environments where full-sealing and a mix of power and signal contacts are required. ITT Cannon's TNM series is an all-metal version similar to MIL-DTL-26482, but lower cost and not intermateable. For full details on the ITT Cannon Trident connector family, see the product specifications below.

APPLICATIONS

Industrial and vehicular connections to and from electronic cabinets and boxes. Any power and signal application requiring total moisture sealing.

- Trucks & buses
- Off-road vehicles
- Rail and mass transit
- Marine
- Process control
- Industrial machinery
- Control cables
- Probes
- Hand controllers
- Remote sensors
- Inter-system connections

FEATURES

STRONG, LIGHT-WEIGHT & LOW-COST

Superior to plastic circular connectors and less costly than metal connectors, Trident's metal bayonet coupling nut and locking mechanism provide strength and life comparable to an all-metal connector. Bodies are composed of durable UL94V0 thermoplastic with high-strength nickel-plated metal coupling nuts and bayonet ring. Molded rubber and silicone seals guarantee water-tightness.

ATTRACTIVE APPEARANCE

Trident connectors are aesthetically-pleasing, making them perfect for front panel mounting.

SUBMERSIBLE OR WATERJET-PROOF VERSIONS

Neptune uses a rear individual wire sealing grommet and is fully submersible to IP67. Ringlock is protected against submersion to IP67 using gland seal cable clamp.

WIDE TEMPERATURE RANGE

Trident will operate in temperatures from -55°C to +120°C (-67° to +248°F) under conditions of high humidity, severe vibration, ice and mud.

WIDE RANGE OF WIRE GAUGES AND CURRENT CARRYING CAPABILITY

Up to 30 amps per contact with wire sizes from 28 AWG up to 12 AWG wire. TNM 700-volt handles up to 40 amp power for up to 8 AWG wire.

STANDARD AND REVERSE CONNECTOR HOUSINGS

In the STANDARD configuration, the receptacles use socket contacts and the plugs use pin contacts. A REVERSED version is also available for safety and/or polarization. Standard and reversed connectors will not intermate. 'Keying Pins' are also available to polarize connectors with the same orientation and layout used on the same panel to prevent mis-mating.

WIDE RANGE OF CONTACT STYLES

Contacts are available in crimp, PC, coax, wire wrap or first mate/last break for ground connections.

FIELD SERVICEABLE

The use of removable crimp contacts allows connections to be changed or modified in the field if necessary. Contacts are copper alloy with a range of gold or tin platings.

AGENCY APPROVALS

- UL and CSA (Trident Ringlock)
- IP67 Submersible

MATERIALS & FINISHES

Shell	UL94V0 thermoplastic with nickel-plated copper alloy coupling nut and bayonet lock ring
Contacts	High-reliability copper alloy available in two versions: stamped and formed or machined
Plating	Tin, gold flash, gold (1 micron), heavy gold (4 microns)
Seals	Rubber, silicone

ELECTRICAL DATA

Operating Voltage	Up to 250 Vac rms degree of pollution permitting per IEC664 (TNM 700-volt power version)
Test Voltage	2000 Vac rms test potential
Current rating	30 Amps (Neptune Power contacts), 13 Amps (Signal contacts). 16 Amp contacts available. TNM 40 amp power.
Wire Range Sizes	28 - 14 AWG (stamped contacts), 28 - 16 AWG (machined), 18 - 12 AWG (Power Neptune) 16 - 8 AWG (Power TNM)
Contact Resistance	5 Milliohms Initial
Insulation Resistance	5000 Megaohms at 500Vdc
Crimp Contacts	Semi-automatic, hand-crimpable or fully-automatic
Wire Size	20 - 16 AWG
Wire Insulation Sealing Range	1.98 mm (.078 in) to 3.30 mm (.130 in) diameter
Contact Insertion	No tool required. Suitable for automation.
Contact Extraction	Rear removable
Contact Retention	20 lbs. minimum per contact
Wire Strip Length	5.59 mm (.220 in) to 5.33 mm (.210 in)

MECHANICAL DATA

Sealing	Up to IP67
Wire Sealing Range	See column 9 on contact chart, ⇨ page 49 .
Insulation Strip Lengths	See column 8 on contact chart, ⇨ page 49 .
Mating Life	500 cycles (machined contacts); 200 cycles (stamped)
Salt Spray	To MIL-STD-1344 Method 1001 (48 hrs. no corrosion)
Heat	Damp Heat to BS 2011 Pt2 Ca, 21 days exposure +105°C to -50°C (5 cycles) remains within specifications
Chemical Resistance	Connectors show no damage when exposed to fluids used in industrial/vehicle applications.
Vibration	5 to 55 Hz (1 minute) No discontinuities longer than 1-microsecond
Shock	50g 11ms MIL-STD-202 Method 213 condition A
Contact Type	Crimp, PC, first mate/last break, co-ax, wire wrap
Number of Circuits	4 to 48
Contact Insertion	From rear. No insertion tool needed. Removable with proper extraction tool (front release).

CONTACT	FORCE (MIN)	
	LBS.	NEWTONS
Machined	25	110
Stamped	15	65

Polarization	Standard or reversed sex shells and/or keying pins
Agency Listing	UL (E102053), CSA (LR68300), TNM: UL, C-UL, E151413
Color	Silver (TNM) or Black with silver coupling nut and ring (Ringlock and Neptune)

EXPLODED VIEW

NEPTUNE

PLUG

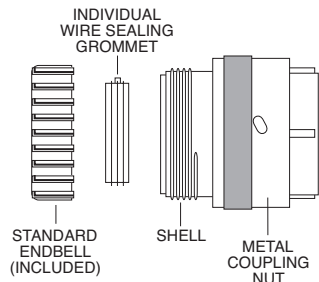

FLANGED RECEPTACLE

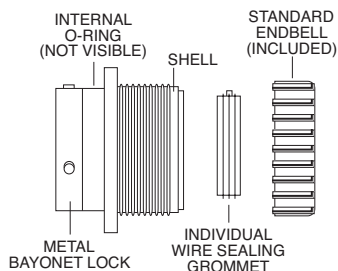

JAM NUT RECEPTACLE

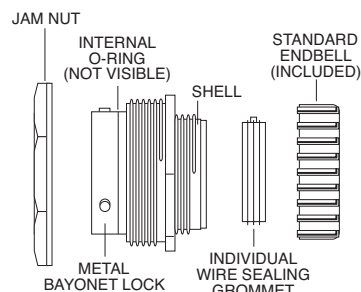

RINGLOCK

PLUG

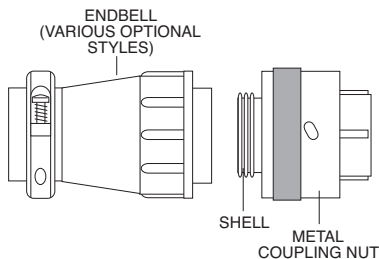

FLANGED RECEPTACLE

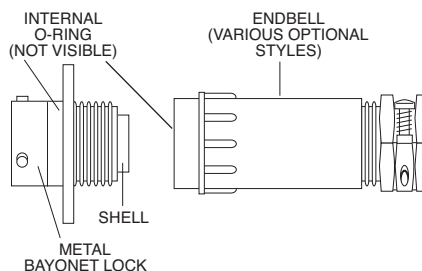

TNM

PLUG

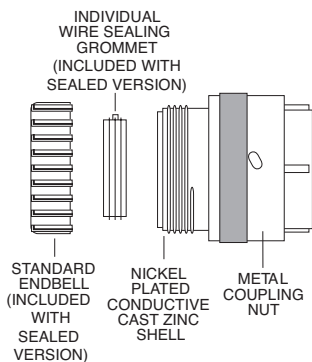

FLANGED RECEPTACLE

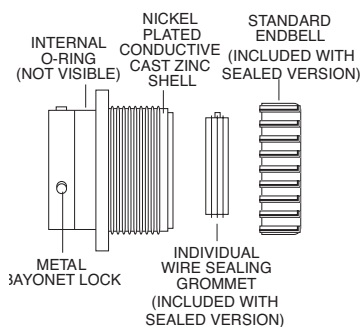

LIGHT ROPE



HIGH POWER



700 VOLT HIGH POWER

SELECT PART NUMBER - STANDARD SEX

INDEX

Neptune (Shaded)



192991-0625 192991-0615

Ringlock

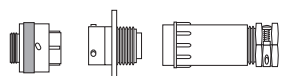

Special High Power
2 Combo-D Contacts
12 Signal Contacts

CONNECTORS

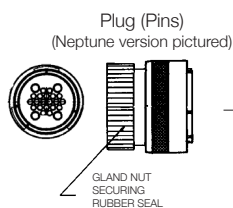

Mates With

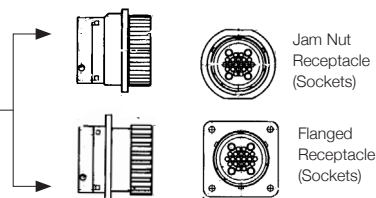

	# OF CIRCUITS	# OF POWER CONTACTS	# OF SIGNAL CONTACTS	SHELL SIZE	PLUGS (PINS)	PLUG (PINS) PLASTIC COUPLING NUT	FLANGED RECEPTACLE (SOCKETS)	JAM NUT RECEPTACLE (SOCKETS)
	4	0	4	10	192922-1250	-	192990-1660	-
	7	0	7	18	192990-1330	-	192990-1700	-
	8	0	8	12	192922-1260	-	192990-1670	-
	12	0	12	14	192922-1270	-	192990-1680	-
	12	0	12	14	192900-0303	-	192900-0308	192900-0313
	15	2	13	16	192900-0507	192900-0561	192900-0509	192900-0508
	19	0	19	16	192922-1280#	-	192990-1690#	-
	19	0	19	16	192900-0017	192900-0557	192900-0039	192900-0490
	23	0	23	18	192990-1320	-	192990-1710	-
	24	4	20	24	192900-0014	192900-0537	192900-0030	192900-0032
	28	0	28	20	192922-1290	-	192990-1720	-
	31	12	19	24	192900-0016	192900-0538	192900-0036	192900-0038
	32	4	28	24	192900-0015	192900-0549	192900-0033	192900-0035
	35	0	35	22	192922-1300	-	192990-1730	-
	48	0	48	24	192990-1340	192990-0553	192990-1740	-
	48	0	48	24	192900-0469 192991-0628 (L)	192900-0539 192991-0660 (L)	192900-0475 192991-0640 (L)	192900-0481 192991-0644 (L)

Mating face of plug for Standard Sex is shown. Reverse Sex has mirror image cavity identification. Shaded columns = Neptune Version - Supplied with individual wire seal. +2 COAX / Power +12 signal. Ringlock version contact us for details.

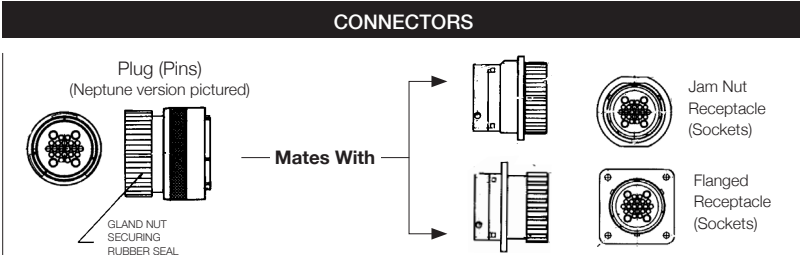
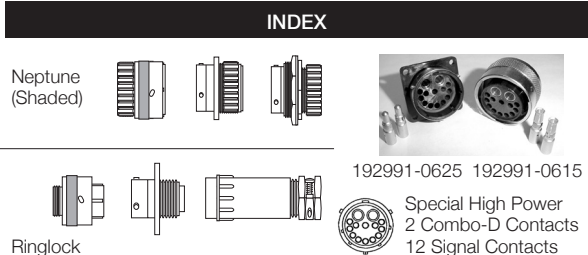







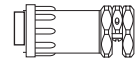
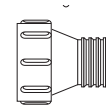
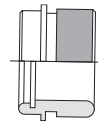
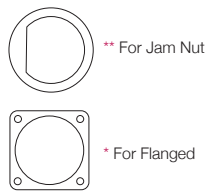

	# OF CIRCUITS	# OF POWER CONTACTS	# OF SIGNAL CONTACTS	SHELL SIZE	PLUG (SOCKETS)	PLUG (SOCKETS) PLASTIC COUPLING NUT	FLANGED RECEPTACLE (PINS)	JAM NUT RECEPTACLE (PINS)
	4	0	4	10	192926-0500	-	192990-1760	-
	7	0	7	18	192990-1390	-	192990-1800	-
	8	0	8	12	192926-0510	-	192990-1770	-
	12	0	12	14	192926-0520	-	192990-1780	-
	12	0	12	14	192900-0236	-	192900-0256	192900-0266
	15	2	13	16	192900-0581	192900-0562	192900-0582	192900-0583
	19	0	19	16	192926-0530#	-	192990-1790#	-
	19	0	19	16	192900-0057	192900-0558	192900-0078	192900-0353
	23	0	23	18	192990-1380	-	192990-1810	-
	24	4	20	24	192900-0054	192900-0540	192900-0069	192900-0071
	28	0	28	20	192926-0540	-	192990-1820	-
	31	12	19	24	192900-0056	192900-0541	192900-0075	192900-0077
	32	4	28	24	192900-0055	192900-0550	192900-0072	192900-0074
	35	0	35	22	192926-0550	-	192990-1830	-
	48	0	48	24	192990-1400	192900-0554	192990-1840	-
	48	0	48	24	192900-0425 192991-0648 (L)	192900-0542 192991-0664 (L)	192900-0431 192991-0652 (L)	192900-0437 192991-0656 (L)

Shaded columns = Neptune Version - Supplied with individual wire seal.

Mates with TNM, but not with Neptune version









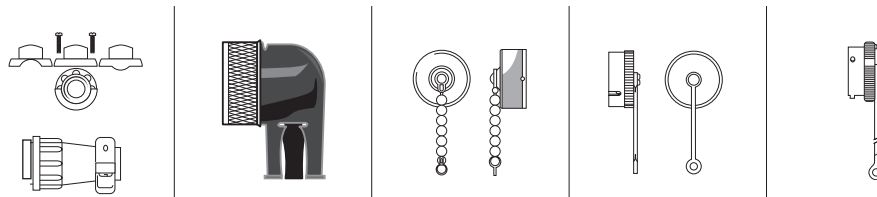









# OF CIRCUITS	SHELL SIZE	SEAL	GASKETS	ENDBELLS			
		NEPTUNE WIRE SEALING RANGE INCHES (MM) MIN OD MAX OD	FOR JAM NUT** FOR FLANGED*	RINGLOCK EXTERNALLY GROOVED FOR HEAT SHRINK	NEPTUNE HEAT SHRINK BOOT OR FLEX TUBING†	WATERPROOF GLAND SEAL ENDBELL •	
	4	10	N/A	075-8543-011	192990-1430	-	192990-1530
	7	18	N/A	075-8543-015	192990-1470	-	192990-1570
	8	12	N/A	075-8543-012	192990-1440	-	192990-1540
	12	14	N/A	075-8543-013	192990-1450	-	192990-1550
	12	14	.067 (1.7) .106 (2.7)	192900-0565* 192900-0457**	-	-	192900-0496
	15	16	Signal: .067 (1.7) .106 (2.7) Power: .106 (2.7) .157 (4.0)	192900-0566* 192900-0402**	-	192991-0015	192900-0497
	19	16	N/A	075-8543-014	192990-1460	-	192990-1560
	19	16	.067 (1.7) .106 (2.7)	192900-0566* 192900-0402**	-	192991-0015	192900-0497
	23	18	N/A	075-8543-015	192990-1470	-	192990-1570
	24	24	Signal: .067 (1.7) .106 (2.7) Power: .106 (2.7) .157 (4.0)	192900-0567* 192900-0458**	-	192991-0013	192900-0498
	28	20	N/A	075-8543-016	192990-1480	-	192990-1580
	31	24	Signal: .067 (1.7) .106 (2.7) Power: .106 (2.7) .157 (4.0)	192900-0567* 192900-0458**	-	192991-0013	192900-0498
	32	24	Signal: .067 (1.7) .106 (2.7) Power: .106 (2.7) .157 (4.0)	192900-0567* 192900-0458**	-	192991-0013	192900-0498
	35	22	N/A	075-8543-017	192990-1490	-	192990-1590
	48	24	N/A	075-8543-018	192990-1500	-	192990-1600
	48	24	.063 (1.6) .087 (2.2) .090 (2.3) .126 (3.2)	192900-0567 192900-0458**	192900-0498	192900-0344	192991-0581

Shaded rows = Neptune Version - Supplied with individual wire seal.
All dimensions in inches (millimeters in parentheses) unless otherwise stated.

• See [page 57](#) for cable sealing range.
† See Accessories [pages 196-201](#) for heat shrink boots and tubing.



# OF CIRCUITS	SHELL SIZE	ENDBELLS		DUST CAPS (ALSO FITS KPT/KPSE SERIES)			
		STANDARD STRAIN RELIEF (UNSEALED)	LOW PROFILE 90°	RECEPTACLE METAL DUST CAP	RECEPTACLE PLASTIC DUST CAP	PLUG PLASTIC DUST CAP ‡	
	4	10	192922-1310	-	192922-1480	192900-0666	192900-0385△
	7	18	192990-1510	-	192990-1410	192900-0670	192900-0389△
	8	12	192922-1320	-	192922-1490	192900-0667	192900-0386△
	12	14	192922-1330	-	192922-1500	192900-0668	192900-0387△
	12	14	192900-0286	192991-0579	192922-1500	192900-0378	192991-0673
	15	16	192900-0343	192991-0580	192922-1510	192900-0379	192900-0388
	19	16	192922-1340	-	192922-1510	192900-0669	192900-0388
	19	16	192900-0343	192991-0580	192922-1510	192900-0379	192900-0388
	23	18	192990-1510	-	192990-1410	192900-0670	192900-0389△
	24	24	192900-0344	192991-0581	192900-1420	192900-0383	192900-0392
	28	20	192922-1350	-	192922-1520	192900-0671	192900-0390△
	31	24	192900-0344	192991-0581	192990-1420	192900-0383	192900-0392
	32	24	192900-0344	192991-0581	192990-1420	192900-0383	192900-0392
	35	22	192922-1360	-	192922-1530	192900-0672	192900-0391△
	48	24	192990-1520	-	192990-1420	192900-0673	192900-0392
	48	24	192900-0344	192991-0581	192990-1420	192900-0383	192900-0392

Shaded rows = Neptune Version - Supplied with individual wire seal.

‡ Plug cap can be panel mounted and used as a dummy receptacle. Contact us for instructions

△ Large minimums may apply to these caps

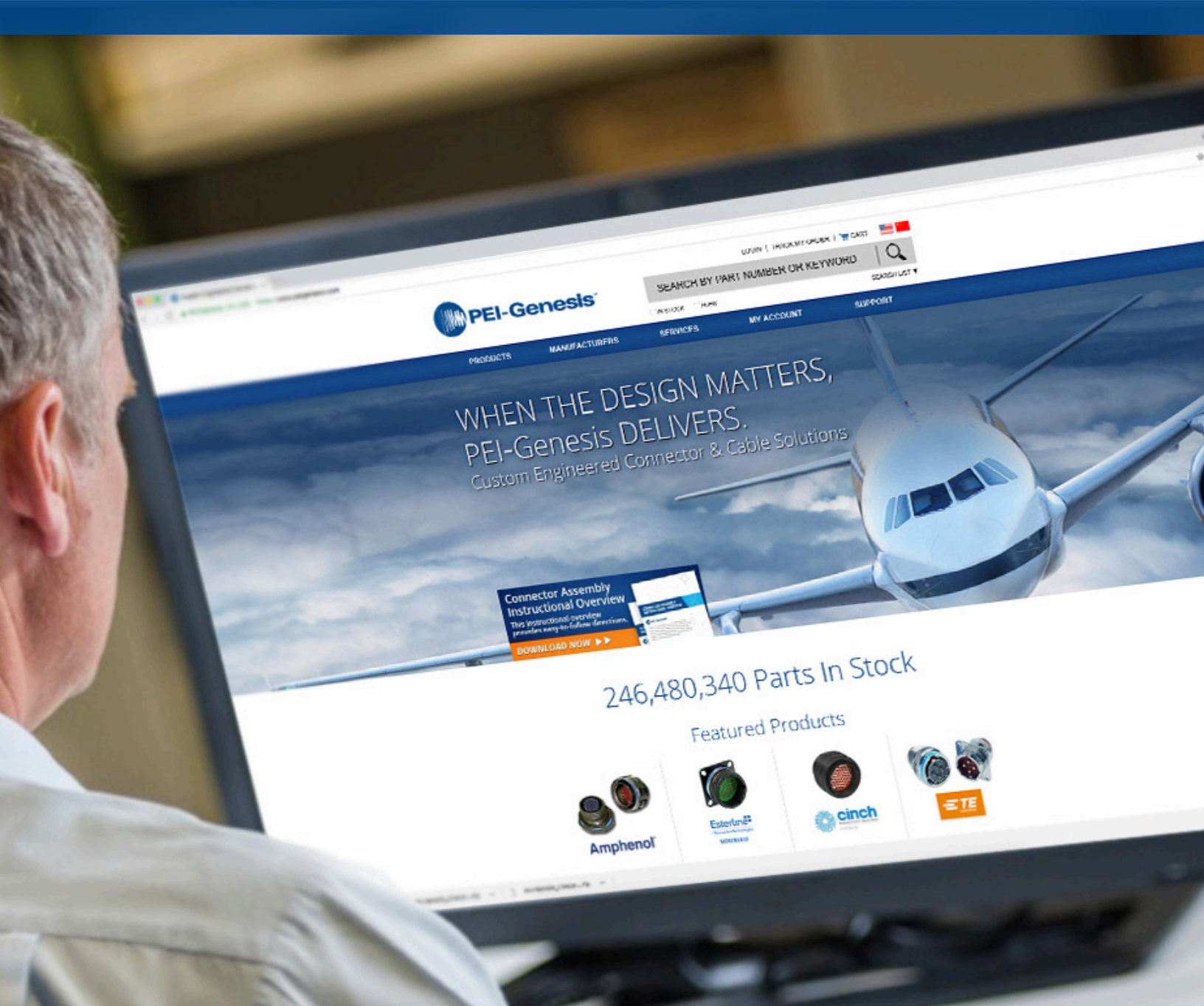

OPEN 24/7

WITH WWW.PEIGENESIS.COM!

+1 800.675.1214 (North America)
 +44 (0) 23 8062 1260 (Europe)
 +86 756 7683 088 (Asia)
 +1 631.475.5050 (Rest of World)



Find Parts Fast with
Parametric Search



Shop Online



Upload Your BOM



Track Your Orders
in Real-Time



View Invoice
History & More

CURRENT RATING (BY AMBIENT TEMPERATURE)

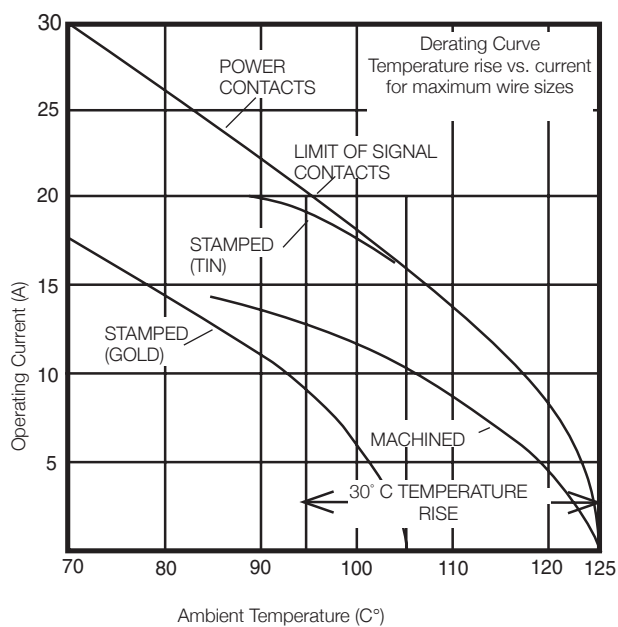

Curves apply to single contacts in isolation. Use of smaller wire gauges or more than one contact in a connector requires derating.





Contact us for additional derating information.

HOW TO SELECT TRIDENT CONNECTORS (⇒ SEE PAGES 42-45)

- STEP 1.** Determine number of circuits required per connector (4 to 48). Note that some Neptune layouts (shaded rows) have a mixture of power and signal contacts.
- STEP 2.** Choose Trident Ringlock (waterjet-proof) or Neptune (submersible). Neptune part numbers are shaded in chart.
- STEP 3.** Select connector sex: STANDARD or REVERSED. Standard plugs have pin contacts, receptacles have sockets. Reversed plugs have socket contacts, receptacles have pins.
- STEP 4.** Choose shell style: PLUG, FLANGED RECEPTACLE, or JAM NUT.
- STEP 5.** Find part number on chart (shaded part numbers are NEPTUNE).
- STEP 6.** Select endbell, if needed. Neptune comes with low profile wire seal endbell; however, all endbells shown can be optionally used with Neptune connectors.
- STEP 7.** Choose dust cap, if required.
- STEP 8.** Select contacts and tooling below.

HOW TO SELECT TRIDENT CONTACTS (⇒ SEE PAGES 48-49)

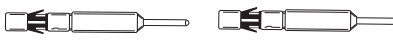
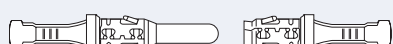
- STEP 1.** Choose stamped or machined contacts.
- STEP 2.** Choose contact type: crimp, PC, power, first mate/last break.
- STEP 3.** Find your desired wire gauge in COLUMN 2.
- STEP 4.** Choose contact plating in COLUMN 3.
- STEP 5.** Select part number from COLUMNS 4, 5, 6, or 7.
- STEP 6.** Select wire hole filler plugs (if needed) from COLUMN 10. Hole filler plugs are for Neptune version only (gray shaded connectors). Hole fillers are only used to re-seal unused grommet cavities that were punched out, but will not be filled with a wire.
- STEP 7.** Select Keying pins (if needed) from COLUMN 11.
- STEP 8.** Choose proper crimp tool for your contact from COLUMNS 12 thru 14.
- STEP 9.** Choose proper extraction tool from COLUMN 15 (insertion tool not needed).
- STEP 10.** Wire strip lengths and insulation dimensions are in COLUMNS 8 and 9.

CONTACTS (1)						
COLUMN 1	COLUMN 2	COLUMN 3	COLUMN 4	COLUMN 5	COLUMN 6	COLUMN 7
TRIDENT CONTACTS	A.W.G. WIRE SIZE	PLATING	LOOSE PINS	3K REEL PIN	LOOSE SOCKETS	3K REEL SOCKETS
STAMPED CRIMP						
 13 Amp-200 insertions	24-26	Tin Gold flash Gold	192990-0020 192990-0080 192900-0448	192990-2510 192990-2650 192900-0406	192990-0030 192990-0090 192900-0452	192990-2550 192990-2690 192900-0410
	20-22	Tin Gold flash Gold	192990-0040 192922-1460 192900-0447	192990-2500 192990-2640 192900-0405	192990-0050 192922-1470 192900-0451	192990-2540 192990-2680 192900-0409
	16-18	Tin Gold flash Gold	192990-0060 192990-0100 192900-0446	192990-2490 192990-2630 192900-0404	192990-0070 192990-0110 192900-0450	192990-2530 192990-2670 192900-0408
Contact us for high-conductivity contacts (16A)						
Non-insulation support	14	Tin Gold flash Gold	192990-1240 192990-1220 192900-0445	192990-2480 192990-2620 192900-0403	192990-1250 192990-1230 192900-0449	192990-2520 192990-2660 192900-0407
MACHINED CRIMP						
 13 Amp-500 insertions	24-28	Gold flash Gold Heavy Gold	192991-0099 192991-0100 192991-0101	- - -	192991-0036 192991-0042 192991-0054	- - -
	24	Gold flash Gold Heavy Gold	192991-0091 192991-0092 192991-0093	- - -	192991-0037 192991-0043 192991-0055	- - -
	22	Gold flash Gold Heavy Gold	192991-0095 192991-0096 192991-0097	- - -	192991-0038 192991-0044 192990-0056	- - -
	20	Gold flash Gold Heavy Gold	192991-0127 192991-0128 192991-0129	- - -	192991-0039 192991-0045 192991-0057	- - -
	20 20 Thick Wire	Gold flash Gold Heavy Gold	192991-0087 192991-0088 192991-0089	- - -	192991-0040 192991-0046 192991-0058	- - -
MACHINED SOLDER FOR PROTOTYPING 28-14 AWG WIRE						
	Pin	Socket				
Tin	192900-0632	192900-0634				
Gold	192900-0633	192900-0635				
FIRST MATE/LAST BREAK MACHINED CRIMP						
 13 Amp-500 insertions	20	Tin Gold flash Gold	192991-0166 192991-0163 192991-0164	- - -	192991-0211 192991-0078 192991-0207	- - -
	16	Tin Gold flash Gold	192991-0162 192991-0159 192991-0160	- - -	192991-0212 192991-0079 192991-0208	- - -
PRINTED CIRCUIT BOARD CONTACTS						
 13 Amp-500 insertions	PC post dia. inches(mm)					
	.043 (1.10)	Tin	192991-0198	-	192991-0204	-
	.043 (1.10)	Gold	192991-0195	-	192991-0067	-
	.03 (.76)	Tin	192991-0122	-	192991-0203	-
	.03 (.76)	Gold	192991-0119	-	192991-0066	-
	Stamped PC pin contacts available, please contact us	.028 (.71)	Tin Signal	192900-0465	-	-
	.028 (.71)	Gold Signal	192900-0356	-	-	-
	.059 (1.50)	Tin Power	192991-0617	-	-	-
POWER STAMPED 30 Amp-200 insertions						
	16-18	Tin	031-8717-020	121668-0000	031-8717-120	121668-0100
	14-16	Tin	031-8717-021	121668-0001	031-8717-121	121668-0101
	12-14	Tin	031-8717-022	121668-0002	031-8717-122	121668-0102
COAX/TWISTED PAIR Used only in signal contact cavities						
Outer Female Contact Assembly	Twisted Pair (B) Coaxial (A)	Gold	192945-4530 192945-4390	-	192945-4930 192945-4380	-
Outer Male Contact Assembly						
						

Shaded rows = Neptune Version - Supplied with individual wire seal.
 All dimensions in inches (millimeters in parentheses) unless otherwise stated.

(1) Loose or 3K Reel
 Stamped contacts are available loose piece or on continuous reels of 3,000 for use with semi-automated crimping systems. Contact us for information.

(2) Wire Hole Fillers (Neptune only)
 The rear Neptune wire seal has individual wire seals that are punched out when inserting the contact. If a seal is accidentally pierced, the seal can be repaired by inserting a wire hole filler.

(3) Keying Pins
 A plastic pin which can be snapped into an unused signal or power contact hole. This will only allow another connector to mate if there is an empty hole opposite the keying pin. Used to polarize similar connectors to avoid mis-mating.

WIRE RANGE		ACCESSORIES	
COLUMN 8	COLUMN 9	COLUMN 10	COLUMN 11
WIRE STRIP LENGTHS INCHES (MM) +.02 +.01	WIRE INSULATION DIAMETER INCHES (MM)	WIRE HOLE FILLERS NEPTUNE ONLY(2)	KEYING PINS(3)

.16 (4.0)	.035 - .0627 (.89 - 1.58)	192991-0018 192991-0018 192991-0018	192990-0000 192990-0000 192990-0000
.16 (4.0)	.046 - .081 (1.17 - 2.08)	192991-0018 192991-0018 192991-0018	192990-0000 192990-0000 192990-0000
.16 (4.0)	.078 - .118 (2.00 - 3.00)	192991-0018 192991-0018 192991-0018	192990-0000 192990-0000 192990-0000
.22 (5.6)	N/A No insulation grip	192991-0018 192991-0018 192991-0018	192991-0018 192991-0018 192991-0018

.20 (5.0)	.035 - .055 (.90 - 1.40)	192991-0018 192991-0018 192991-0018	192990-0000 192990-0000 192990-0000
.20 (5.0)	.041 - .062 (1.05 - 1.60)	192991-0018 192991-0018 192991-0018	192990-0000 192990-0000 192990-0000
.20 (5.0)	.062 - .084 (1.60 - 2.15)	192991-0018 192991-0018 192991-0018	192990-0000 192990-0000 192990-0000
.20 (5.0)	.051 - .070 (1.30 - 1.80)	192991-0018 192991-0018 192991-0018	192990-0000 192990-0000 192990-0000
.20 (5.0)	.062 - .082 (1.60 - 2.10)	192991-0018 192991-0018 192991-0018	192990-0000 192990-0000 192990-0000
.28 (7.1)	N/A No insulation grip	192991-0018 192991-0018 192991-0018	192990-0000 192990-0000 192990-0000

.20 (5.0)	.062 - .082 (1.60 - 2.10)	192991-0018 192991-0018 192991-0018	192990-0000 192990-0000 192990-0000
.28 (7.1)	N/A No insulation grip	192991-0018 192991-0018 192991-0018	192990-0000 192990-0000 192990-0000

N/A	N/A	- - - - -	192990-0010 pin 192990-7650 skt
-----	-----	-----------------------	------------------------------------

.20 (5.0)	.055-.079 (1.4 - 2.0) .079-.114 (2.0 - 2.9) .114-.142 (2.9 - 3.6)	192991-0019 192991-0019 192991-0019	192990-0189 192990-0189 192990-0189
-----------	---	---	---

TOOLS			
COLUMN 12	COLUMN 13	COLUMN 14	COLUMN 15
AUTOMATIC CRIMP TOOLING → PAGE 59		ECONOMY NON-RATCHETING HAND CRIMP TOOL(5)	EXTRACTION TOOL(6)
HAND CRIMP TOOL(4)			

121586-5236 (20-26 AWG)		192922-1440	192922-1450 192922-1450 192922-1450
121586-5237 (16-18 AWG)			192922-1450 192922-1450 192922-1450
121586-5238 (14-16 AWG)			192922-1450 192922-1450 192922-1450

LOCATOR(4)

AF8	TH499	-	192922-1450
AF8	TH499	-	192922-1450
AF8	TH499	-	192922-1450
AF8	TH499	-	192922-1450
AF8	TH499	-	192922-1450
AF8	TH499	-	192922-1450
AF8	TH499	-	192922-1450
AF8	TH499	-	192922-1450
AF8	TH499	-	192922-1450
AF8	TH499	-	192922-1450
AF8	TH499	-	192922-1450
AF8	TH499	-	192922-1450

AF8	TH499	-	192922-1450
AF8	TH499	-	192922-1450
AF8	TH499	-	192922-1450
AF8	TH499	-	192922-1450
AF8	TH499	-	192922-1450
AF8	TH499	-	192922-1450
AF8	TH499	-	192922-1450

-	-	-	192922-1450
-	-	-	192922-1450
-	-	-	192922-1450
-	-	-	192922-1450
-	-	-	-
-	-	-	-
-	-	-	-

HAND CRIMP TOOL (4)			
112108-0012		192922-1440	192900-0176
112108-0012		192922-1440	192900-0176
112108-0011		-	192900-0176

	HAND CRIMP TOOL (4)	LOCATOR(4)		
Contact us for data sheet containing wire preparation information, tooling, and cable types.	Inner Conductor AFM8	K151		192922-1450
	Outer Conductor GS100-1	GP295	-	

(4) Hand Crimp Tool & Locator
Hand crimp tools produce consistent, high quality crimps by using a ratchet mechanism which will only release the contact when the crimp is completed. Stamped contacts use a tool with integrated dies. Machined contacts use a military style tool (MIL-C-22520/1) which also requires the appropriate locator to form a complete crimping system.

(5) Economy Crimp Tool (stamp contacts only)
This is a pliers-style tool for prototype or service use. It has no ratchet and the completed crimp requires two separate operations, one to crimp the conductor and a second crimp to secure the insulation support. The economy tool covers wire gauges 16, 20 and 24 AWG and is for use with stamped contacts only.

(6) Extraction Tool
Contacts can be easily removed by placing the extraction tool over the contact in the front of the connector and pushing. The contact is ejected from the rear of the connector. No insertion tool is needed for any Trident contacts.

TRIDENT NEPTUNE METAL (TNM)



TNM 700 Volt Power Connector System Shell Size 16

The TNM range of connectors is an extension of the long-established Neptune and Trident Ringlock connector series but with a number of additional features. These include RF shielding and moisture sealing to IP67.

The connectors feature strong nickel-plated zinc alloy shells with a metal coupling ring for high reliability and durability. When used with the new low cost shielded endbells, the connector system provides RF shielding from cable to equipment or cable to cable that satisfy EMC requirements.

The signal contacts are from the standard Trident contact range → See page 48-49. The recommended contacts are the stamped and formed Two Part, available with either tin or gold-plated finish. If a higher performance is required, the Trident Three Part machined contacts can be used. All signal contacts have a current rating of 13 Amps and wires with conductors 14 - 28AWG (2.50 mm² - .08 mm²) can be accommodated. Note if more than 4 contacts per connector are designed to run at, or near, their full rated current for sustained periods, a derating factor must be applied. For further details, please contact us.

LAYOUTS

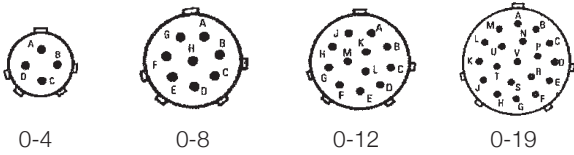

Mating face of plug for standard sex is shown. Reverse sex has mirror image cavity identification.

POWER CONTACT TNM 700 VOLTS ONLY			
TYPE	SOCKETS	PINS	AMP MAX.
Solder	DM53744-21	DM53745-28	40
Crimp 8-10Awg	DM130341-1	DM130338-1	40
Crimp 12-14Awg	DM130342-1	DM130339-1	20
Crimp 16-18Awg	DM130343-1	DM130340-1	10

See Technical Specifications → See page 40-41.



Sealed Plug



Sealed Flanged Receptacle



Unsealed Plug †



Unsealed Flanged Receptacle †

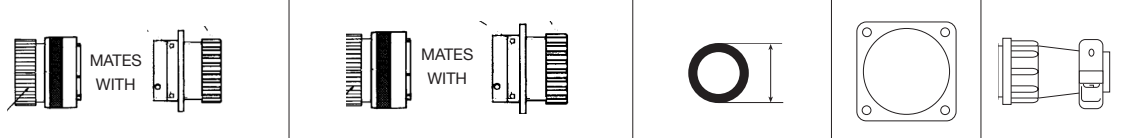

NUMBER OF CONTACTS	SHELL SIZE	STANDARD SEX		REVERSE SEX		WIRE SEALING RANGE FOR SEALED VERSIONS INCHES (MM)	GASKETS	STANDARD PLASTIC UNSEALED ENDBELL
		PLUG (PINS)	FLANGED RECEPTACLE (SOCKETS)	PLUG (SOCKETS)	FLANGED RECEPTACLE (PINS)			
4	10	192993-0011	192993-0031	192993-0051	192993-0071	.055 (1.4) - .086 (2.2)	075-8543-011	192900-0639
4†	10	192993-0001	192993-0021	192993-0041	192993-0061	No Wire Seal	075-8543-011	192900-0639
8	12	192993-0012	192993-0032	192993-0052	192993-0072	.055 (1.4) - .086 (2.2)	075-8543-012	192900-0640
8†	12	192993-0002	192993-0022	192993-0042	192993-0062	No Wire Seal	075-8543-012	192900-0640
12	14	192993-0013	192993-0033	192993-0053	192993-0073	.055 (1.4) - .086 (2.2)	192900-0565	192900-0286
12†	14	192993-0003	192993-0023	192993-0043	192993-0063	No Wire Seal	192900-0565	192900-0286
19	16	192993-0014	192993-0034	192993-0054	192993-0074	.055 (1.4) - .086 (2.2)	192900-0566	192900-0343
19†	16	192993-0004	192993-0024	192993-0044	192993-0064	No Wire Seal	192900-0566	192900-0343

† Without wire seal but waterproof to IP67 when used with waterproof endbell.
All dimensions in inches (millimeters in parentheses) unless otherwise stated.



192993-008_



192993-009_

Low Cost Shielded Gland Seal Endbell

In order to meet EMC requirements, it is necessary to fit a shielded endbell to the TNM connector. The TNM Shielded Gland Seal Endbell provides for a simple and effective way to terminate, shield and properly seal round jacketed cables. Contact us for right angle extenders S4810 or for dimensional drawings.

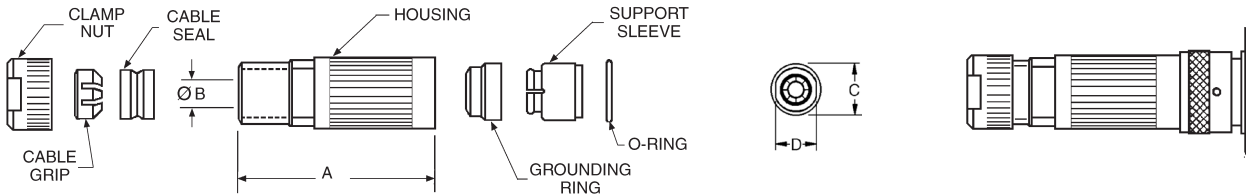

SHELL SIZE	PART NUMBER	A	B	C	D	E (STD.)	E (REV.)
10	192993-0081	2.228 (56.6)	.315 (8.0)	.705 (17.9)	.512 (13.0)	3.484 (88.5)	3.150 (80.0)
12	192993-0082	2.232 (56.7)	.394 (10.0)	.827 (21.0)	.630 (16.0)	3.484 (88.5)	3.150 (80.0)
14	192993-0083	2.244 (57.0)	.449 (11.3)	.945 (24.0)	.748 (19.0)	3.484 (88.5)	3.150 (80.0)
16	192993-0084	2.260 (57.4)	.535 (13.6)	1.079 (27.4)	.866 (22.0)	3.484 (88.5)	3.150 (80.0)

All dimensions in inches (millimeters in parentheses) unless otherwise stated.

STEP 1: Slide O ring over connector body and it will fit into a groove just past the accessory threading.

STEP 2: Slide clamp nut, cable clamp (note: cable clamp compression fingers point toward the connector body), gland seal, (use isopropyl alcohol to slide rubber gland), metal endbell body, metal shielding cone and plastic retention clip, in that order, over your jacketed cable.

STEP 3: Strip back cable jacket as shown.

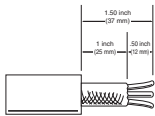

STEP 4: Terminate and insert contacts per assembly instructions → on page 58-60.

STEP 5: Slide plastic retention clip onto the connector body.

STEP 6: Pull braided cable shield over plastic retention clip.

STEP 7: Slide metal shielding cone down until it snaps on to the plastic retention clip. The braided cable shield should now be captured between the plastic retention clip and metal shielding cone.

STEP 8: Fold remaining braided cable shield back over the metal shielding cone.

STEP 9: Slide the metal endbell body down the cable and tighten by hand.

STEP 10: Slide gland seal and cable clamp down into the back of the metal endbell. (Note: isopropyl alcohol will assist in sliding rubber gland seal on cable).

STEP 11: Tighten endbell with appropriate wrench and endbell assembly tools.

STEP 12: Push the cable grip up against the gland seal, then thread clamp nut onto endbell body and tighten to 10Nm +/-1Nm (88.50 inch/pounds).

PLASTIC WATERPROOF GLAND SEAL ENDBELL	CABLE JACKET SEALING RANGE FOR PLASTIC ENDBELL INCHES (MM)	SHIELDED METAL WATERPROOF GLAND SEAL ENDBELL	CABLE JACKET SEALING RANGE FOR METAL SHIELDED ENDBELL INCHES (MM)	RECEPTACLE METAL DUST CAP	RECEPTACLE PLASTIC DUST CAP	METAL PLUG DUST CAP
192900-0637	.224 (5.7)-.366 (9.3)	192993-0082	.252 (6.4)-.374 (9.5)	192990-1490	192900-0377	MS3180-12CA
192900-0637	.224 (5.7)-.366 (9.3)	192993-0092	.236 (6.0)-.472 (12.0)	192990-1490	192900-0377	MS3180-12CA
192900-0496	.256 (6.5)-.488 (12.4)	192993-0083	.272 (6.9)-.402 (10.2)	192922-1500	192900-0378	MS3180-14CA
192900-0496	.256 (6.5)-.488 (12.4)	192993-0093	.275 (7.0)-.551 (14.0)	192922-1500	192900-0378	MS3180-14CA
192900-0497	.256 (6.5)-.630 (16.0)	192993-0084	.311 (7.9)-.496 (12.6)	192922-1510	192900-0379	MS3180-16CA
192900-0497	.256 (6.5)-.630 (16.0)	192993-0094	.314 (8.0)-.629 (16.0)	192922-1510	192900-0379	MS3180-16CA

† Without wire seal but waterproof to IP67 when used with waterproof endbell.
All dimensions in inches (millimeters in parentheses) unless otherwise stated.

DIMENSIONS

TNM STANDARD PLUG

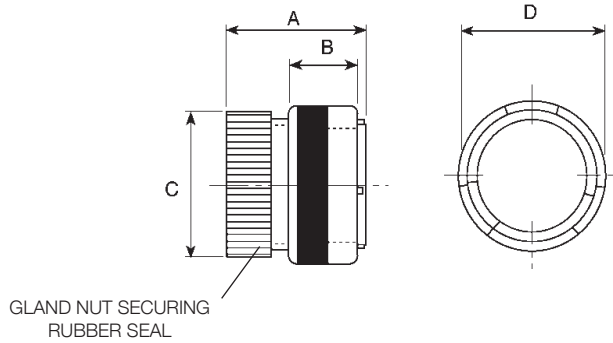

NUMBER OF CONTACTS	SHELL SIZE	PART NUMBER	A	B	C	D
4	10	192993-0011	1.673 (42.5)	.580 (14.7)	.689 (17.5)	.850 (21.6)
4†	10	192993-0001	1.500 (38.1)	.580 (14.7)	.543 (13.8)	.850 (21.6)
8	12	192993-0012	1.673 (42.5)	.580 (14.7)	.811 (20.6)	.976 (24.8)
8†	12	192993-0002	1.500 (38.1)	.580 (14.7)	.665 (16.9)	.976 (24.8)
12	14	192993-0013	1.673 (42.5)	.580 (14.7)	.957 (24.3)	1.102 (28.0)
12†	14	192993-0003	1.500 (38.1)	.580 (14.7)	.791 (20.1)	1.102 (28.0)
19	16	192993-0014	1.673 (42.5)	.580 (14.7)	1.063 (27.0)	1.229 (31.2)
19†	16	192993-0004	1.500 (38.1)	.580 (14.7)	.917 (23.3)	1.229 (31.2)

† Dimensions without wire seal and standard wire seal endbell.

TNM STANDARD FLANGED RECEPTACLES

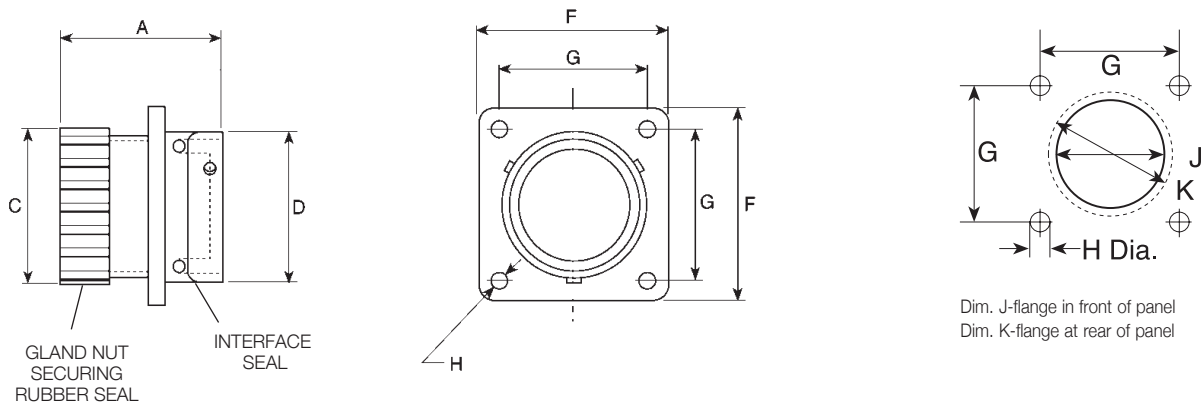

NUMBER OF CONTACTS	SHELL SIZE	PART NUMBER	A	C	D	F	G	H	J	K
4	10	192993-0031	1.366 (34.7)	.689 (17.5)	.587 (14.92)	.937 (23.79)	.719 (18.26)	.126 (3.2)	.594 (15.1)	.681 (17.3)
4†	10	192993-0021	1.193 (30.3)	.563 (14.3)	.587 (14.92)	.937 (23.79)	.719 (18.26)	.126 (3.2)	.594 (15.1)	.681 (17.3)
8	12	192993-0032	1.366 (34.7)	.811 (20.6)	.747 (18.98)	1.030 (26.15)	.812 (20.62)	.126 (3.2)	.717 (18.2)	.858 (21.8)
8†	12	192993-0022	1.193 (30.3)	.685 (17.4)	.747 (18.98)	1.030 (26.15)	.812 (20.62)	.126 (3.2)	.717 (18.2)	.858 (21.8)
12	14	192993-0033	1.366 (34.7)	.957 (24.3)	.872 (22.16)	1.124 (28.54)	.898 (22.80)	.138 (3.5)	.843 (21.4)	.984 (25.0)
12†	14	192993-0023	1.193 (30.3)	.811 (20.6)	.872 (22.16)	1.124 (28.54)	.898 (22.80)	.138 (3.5)	.843 (21.4)	.984 (25.0)
19	16	192993-0034	1.366 (34.7)	1.063 (27.0)	.997 (25.33)	1.216 (30.89)	.969 (24.61)	.138 (3.5)	.969 (24.6)	1.106 (28.1)
19†	16	192993-0024	1.193 (30.3)	.937 (23.8)	.997 (25.33)	1.216 (30.89)	.969 (24.61)	.138 (3.5)	.969 (24.6)	1.106 (28.1)

† Dimensions without wire seal and standard wire seal endbell.
All dimensions in inches (millimeters in parentheses) unless otherwise stated.

TNM REVERSED PLUG

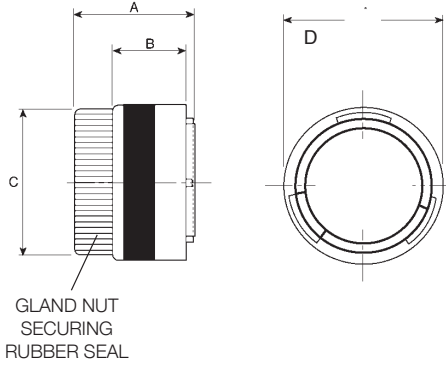

NUMBER OF CONTACTS	SHELL SIZE	PART NUMBER	A	B	C	D
4	10	192993-0051	1.346 (34.2)	.580 (14.7)	.689 (17.5)	.850 (21.6)
4†	10	192993-0041	1.173 (29.8)	.580 (14.7)	.543 (13.8)	.850 (21.6)
8	12	192993-0052	1.346 (34.2)	.580 (14.7)	.811 (20.6)	.976 (24.8)
8†	12	192993-0042	1.173 (29.8)	.580 (14.7)	.665 (16.9)	.976 (24.8)
12	14	192993-0053	1.346 (34.2)	.580 (14.7)	.957 (24.3)	1.102 (28.0)
12†	14	192993-0043	1.173 (29.8)	.580 (14.7)	.791 (20.1)	1.102 (28.0)
19	16	192993-0054	1.346 (34.2)	.580 (14.7)	1.063 (27.0)	1.229 (31.2)
19†	16	192993-0044	1.173 (29.8)	.580 (14.7)	.917 (23.3)	1.229 (31.2)

† Dimensions without wire seal and standard wire seal endbell.

TNM REVERSED FLANGED RECEPTACLES

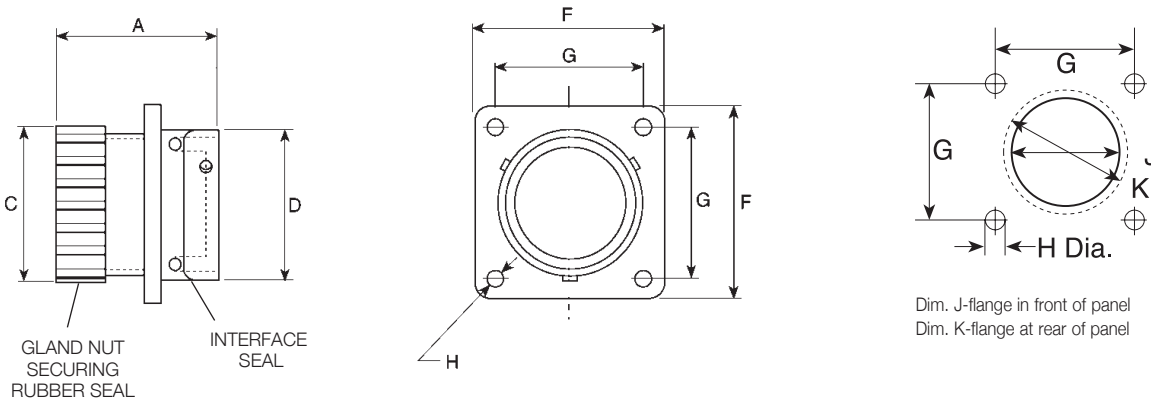

NUMBER OF CONTACTS	SHELL SIZE	PART NUMBER	A	C	D	F	G	H	J	K
4	10	192993-0071	1.693 (43.0)	.689 (17.5)	.587 (14.92)	.937 (23.79)	.719 (18.26)	.126 (3.2)	.594 (15.1)	.681 (17.3)
4†	10	192993-0061	1.520 (38.6)	.563 (14.3)	.587 (14.92)	.937 (23.79)	.719 (18.26)	.126 (3.2)	.594 (15.1)	.681 (17.3)
8	12	192993-0072	1.693 (43.0)	.811 (20.6)	.747 (18.98)	1.030 (26.15)	.812 (20.62)	.126 (3.2)	.717 (18.2)	.858 (21.8)
8†	12	192993-0062	1.520 (38.6)	.685 (17.4)	.747 (18.98)	1.030 (26.15)	.812 (20.62)	.126 (3.2)	.717 (18.2)	.858 (21.8)
12	14	192993-0073	1.693 (43.0)	.957 (24.3)	.872 (22.16)	1.124 (28.54)	.898 (22.80)	.138 (3.5)	.843 (21.4)	.984 (25.0)
12†	14	192993-0063	1.520 (38.6)	.811 (20.6)	.872 (22.16)	1.124 (28.54)	.898 (22.80)	.138 (3.5)	.843 (21.4)	.984 (25.0)
19	16	192993-0074	1.693 (43.0)	1.063 (27.0)	.997 (25.33)	1.216 (30.89)	.969 (24.61)	.138 (3.5)	.969 (24.6)	1.106 (28.1)
19†	16	192993-0064	1.520 (38.6)	.937 (23.8)	.997 (25.33)	1.216 (30.89)	.969 (24.61)	.138 (3.5)	.969 (24.6)	1.106 (28.1)

† Dimensions without wire seal and standard wire seal endbell.
All dimensions in inches (millimeters in parentheses) unless otherwise stated.

DIMENSIONS

STANDARD PLUG

RINGLOCK

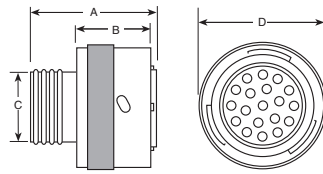

NEPTUNE

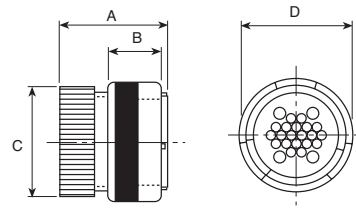

LAYOUT	SHELL SIZE	STANDARD PLUG	A	B	C	D
0-4	10	192922-1250	1.252	0.756	0.429	0.850
0-7	18	192922-1330	1.299	0.756	0.885	1.350
0-8	12	192922-1260	1.252	0.756	0.543	0.976
0-12	14	192922-1270	1.252	0.756	0.669	1.102
0-12	14	192900-0303	1.527	0.756	0.956	1.102
2-13	16	192900-0507	1.566	0.751	1.063	1.189
0-19	16	192922-1280	1.252	0.751	0.783	1.228
0-19	16	192900-0017	1.566	0.756	1.063	1.189
0-23	18	192990-1320	1.252	0.756	0.881	1.350
4-20	24	192900-0014	1.566	0.580	1.594	1.732
0-28	20	192922-1290	1.252	0.751	1.007	1.476
12-19	24	192900-0016	1.566	0.756	1.594	1.732
4-28	24	192900-0015	1.566	0.756	1.594	1.732
0-35	22	192922-1300	1.252	0.580	1.122	1.602
0-48	24	192990-1340	1.252	0.756	1.248	1.728
0-48	24	192900-0469	1.566	0.756	1.594	1.732
0-48 (L)	24	192991-0628	2.000	0.756	1.594	1.732

All dimensions are in inches.

Shaded rows = Neptune Version - Supplied with individual wire seal

STANDARD FLANGED RECEPTACLE

RINGLOCK

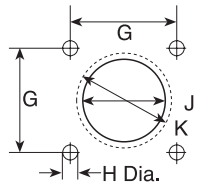
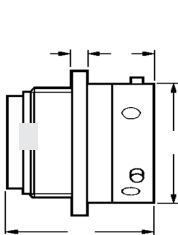

Dim. J-flange in front of panel
Dim. K-flange at rear of panel

NEPTUNE

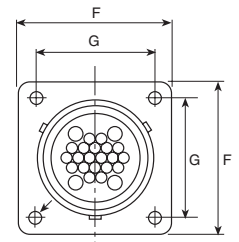
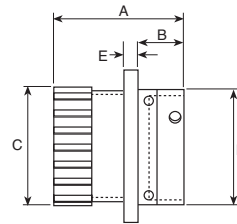

NUMBER OF CONTACTS	SHELL SIZE	STANDARD FLANGED RECEPTACLE	A	B	C	D	E	F	G	H	J	K
0-4	10	192990-1660	1.016	0.439	0.433	0.591	0.091	0.925	0.709	0.128	0.594	0.681
0-7	8	192990-1700	1.280	0.716	0.886	1.122	0.098	1.311	1.063	0.128	1.094	1.232
0-8	12	192990-1670	1.016	0.447	0.547	0.748	0.091	1.031	0.807	0.128	0.717	0.858
0-12	14	192990-1680	1.016	0.447	0.673	0.874	0.091	1.108	0.890	0.128	0.842	0.984
0-12	14	192900-0308	1.563	0.448	0.956	0.874	0.091	1.122	0.901	0.126	0.968	0.968
2-13	16	192900-0509	1.566	0.448	1.063	1.000	0.091	1.220	0.964	0.126	1.106	1.106
0-19	16	192990-1690	1.016	0.447	0.787	1.000	0.091	1.200	0.953	0.128	0.968	1.106
0-19	16	192900-0039	1.566	0.448	1.063	1.000	0.091	1.220	0.964	0.126	1.106	1.106
0-23	18	192990-1710	1.016	0.447	0.886	1.122	0.098	1.311	1.059	0.128	1.094	1.232
4-20	24	192900-0030	1.645	0.606	1.578	1.500	0.138	2.000	1.563	0.165	1.614	1.614
0-28	20	192990-1720	1.311	0.571	1.012	1.248	0.098	1.437	1.150	0.128	1.216	1.358
12-19	24	192900-0036	1.645	0.606	1.578	1.500	0.138	2.000	1.563	0.165	1.614	1.614
4-28	24	192900-0033	1.645	0.606	1.578	1.500	0.138	2.000	1.563	0.165	1.614	1.614
0-35	22	192990-1730	1.311	0.571	1.126	1.374	0.138	1.563	1.244	0.128	1.342	1.484
0-48	24	192990-1740	1.311	0.602	1.252	1.500	0.138	1.689	1.356	0.154	1.468	1.610
0-48	24	192900-0475	1.645	0.606	1.578	1.500	0.138	2.000	1.563	0.165	1.614	1.614
0-48 (L)	24	192991-0640	2.075	0.606	1.578	1.500	0.138	2.000	1.563	0.165	1.614	1.614

All dimensions are in inches.

Shaded rows = Neptune Version - Supplied with individual wire seal

STANDARD JAM NUT RECEPTACLE

NEPTUNE ONLY

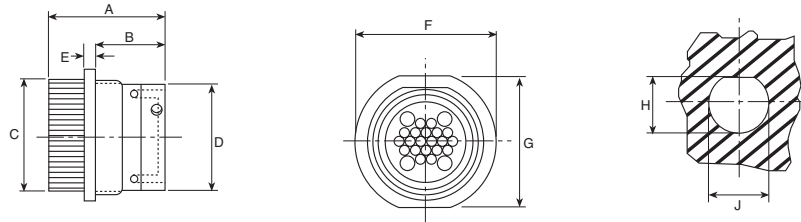

LAYOUT	SHELL SIZE	STANDARD JAM NUT RECEPTACLE	A	B	C	D	E	F	G	H	J
0-12	14	192900-0313	1.563	0.870	0.956	0.874	0.138	1.410	1.267	0.988	1.075
0-19	16	192900-0490	1.565	0.905	1.063	1.000	0.090	1.566	1.511	1.102	1.200
2-13	16	192900-0508	1.565	0.905	1.063	1.000	0.090	1.566	1.511	1.102	1.200
4-20	24	192900-0032	1.646	0.921	1.579	1.500	0.138	2.008	1.870	1.634	1.701
12-19	24	192900-0038	1.646	0.921	1.579	1.500	0.138	2.008	1.870	1.634	1.701
4-28	24	192900-0035	1.646	0.921	1.579	1.500	0.138	2.008	1.870	1.634	1.701
0-48 (L)	24	192991-0644	2.075	0.921	1.579	1.500	0.138	2.008	1.870	1.634	1.701
0-48	24	192900-0481	1.646	0.921	1.579	1.500	0.138	2.008	1.870	1.634	1.701

All dimensions are in inches.
 Shaded rows = Neptune Version - Supplied with individual wire seal

REVERSE PLUG

RINGLOCK

NEPTUNE

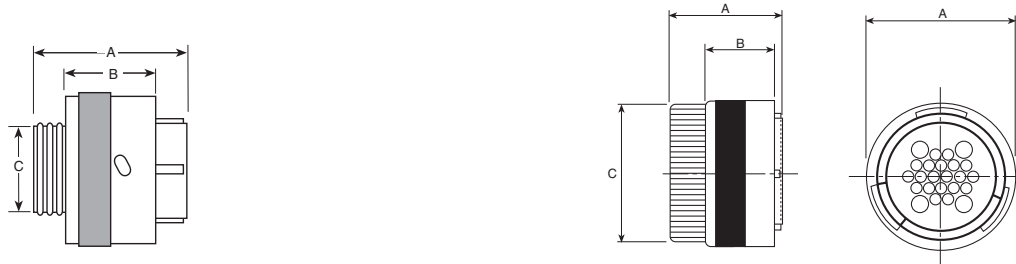

LAYOUT	SHELL SIZE	REVERSE PLUG	A	B	C	D
0-4	10	192926-0500	1.027	0.752	0.433	0.850
0-8	12	192926-0510	1.008	0.752	0.547	0.976
0-12	14	192926-0520	1.055	0.752	0.673	1.102
0-12	14	192900-0236	1.244	0.752	0.957	1.102
0-19	16	192926-0530	1.087	0.752	0.787	1.228
0-19	16	192900-0057	1.248	0.752	1.063	1.189
2-13	16	192900-0581	1.248	0.752	1.063	1.189
0-7	18	192990-1390	1.240	0.752	0.885	1.350
0-23	18	192990-1380	1.008	0.752	0.885	1.350
0-28	20	192926-0540	1.232	0.752	1.011	1.476
0-35	22	192926-0550	1.232	0.752	1.126	1.602
4-20	24	192900-0054	1.275	0.580	1.594	1.732
12-19	24	192900-0056	1.275	0.580	1.594	1.732
4-28	24	192900-0055	1.275	0.580	1.594	1.732
0-48 (L)	24	192991-0648	1.693	0.580	1.594	1.732
0-48	24	192900-0425	1.275	0.580	1.594	1.732
0-48	24	192990-1400	1.232	0.580	1.225	1.728

All dimensions are in inches.
 Shaded rows = Neptune Version - Supplied with individual wire seal

REVERSE FLANGED RECEPTACLE

RINGLOCK

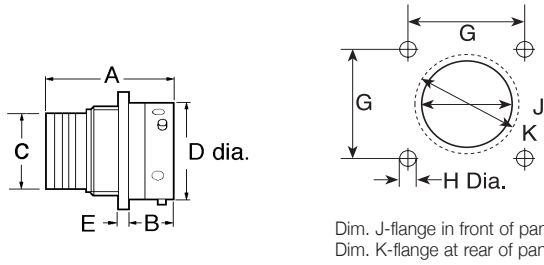

NEPTUNE

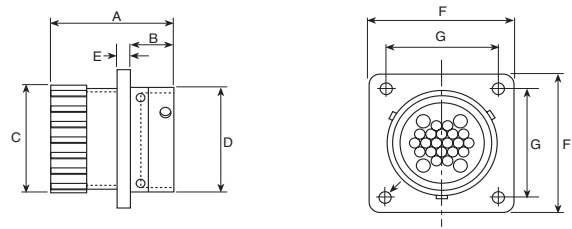

LAYOUT	SHELL SIZE	REVERSE FLANGED RECEPTACLE	A	B	C	D	E	F	G	H	J	K
0-4	10	192990-1760	1.24	0.447	0.433	0.591	0.091	0.925	0.709	0.128	0.594	0.681
0-7	18	192990-1800	1.346	0.700	0.886	1.122	0.091	1.311	1.063	0.128	1.094	1.232
0-8	12	192990-1770	1.240	0.447	0.547	0.748	0.091	1.031	0.807	0.128	0.717	0.858
0-12	14	192990-1780	1.240	0.447	0.673	0.874	0.091	1.108	0.890	0.128	0.843	0.984
0-12	14	192900-0256	1.563	0.448	0.956	0.874	0.090	1.122	0.901	0.126	0.968	0.968
2-13	16	192900-0582	1.566	0.448	1.063	1.000	0.090	1.220	0.964	0.126	1.106	1.106
0-19	16	192990-1790	1.240	0.447	0.787	1.000	0.091	1.200	0.953	0.128	0.969	1.106
0-19	16	192900-0078	1.566	0.448	1.063	1.000	0.090	1.220	0.964	0.126	1.106	1.106
0-23	18	192990-1810	1.240	0.447	0.886	1.122	0.098	1.311	1.059	0.128	1.094	1.232
4-20	24	192900-0069	1.646	0.606	1.578	1.500	0.137	2.000	1.563	0.165	1.614	1.614
0-28	20	192990-1820	1.299	0.573	1.012	1.248	0.098	1.437	1.150	0.128	1.217	1.358
12-19	24	192900-0075	1.646	0.606	1.578	1.500	0.137	2.000	1.563	0.165	1.614	1.614
4-28	24	192900-0072	1.646	0.606	1.578	1.500	0.137	2.000	1.563	0.165	1.614	1.614
0-35	22	192990-1830	1.299	0.573	1.126	1.374	0.138	1.563	1.244	0.128	1.343	1.484
0-48	24	192990-1840	1.370	0.604	1.252	1.498	0.138	1.689	1.356	0.154	1.469	1.610
0-48	24	192900-0431	1.646	0.606	1.578	1.500	0.137	2.000	1.563	0.165	1.614	1.614
0-48 (L)	24	192991-0652	2.075	0.606	1.578	1.500	0.137	2.000	1.563	0.165	1.614	1.614

All dimensions are in inches.
Shaded rows = Neptune Version - Supplied with individual wire seal

REVERSE JAM NUT RECEPTACLE

NEPTUNE ONLY

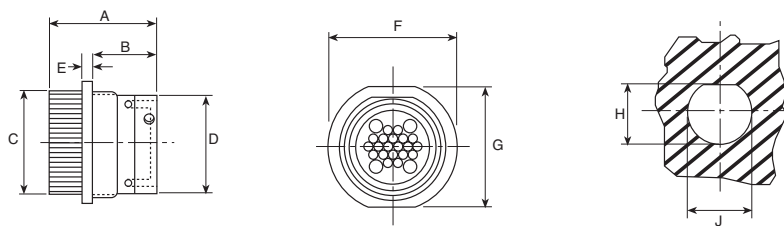

LAYOUT	SHELL SIZE	REVERSE JAM NUT RECEPTACLE	A	B	C	D	E	F	G	H	J
0-12	14	192900-0266	1.563	0.870	0.956	0.874	0.137	1.409	1.267	0.988	1.075
2-13	16	192900-0583	1.566	0.905	1.063	1.000	0.090	1.212	1.503	1.102	1.200
0-19	16	192900-0353	1.566	0.905	1.063	1.000	0.090	1.212	1.503	1.102	1.200
4-20	24	192900-0071	1.645	0.921	1.578	1.500	0.137	2.007	1.870	1.633	1.700
12-19	24	192900-0077	1.645	0.921	1.578	1.500	0.137	2.007	1.870	1.633	1.700
4-28	24	192900-0074	1.645	0.921	1.578	1.500	0.137	2.007	1.870	1.633	1.700
0-48	24	192900-0437	1.646	0.921	1.578	1.500	0.137	2.007	1.870	1.633	1.700
0-48 (L)	24	192991-0656	2.075	0.921	1.578	1.500	0.137	2.007	1.870	1.633	1.700

All dimensions are in inches.
Shaded rows = Neptune Version - Supplied with individual wire seal

SEALED CABLE CLAMPS FOR USE WITH JACKETED CABLES

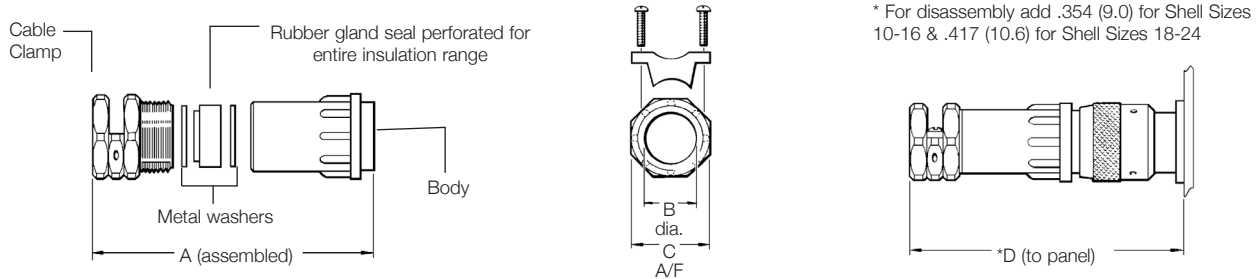

SHELL SIZE	PART #	DIMENSIONS				WIRE SEALING DIAMETER INCHES (MM)		REAR THREAD
		A MAX	B MAX	C+ .007 (.20)	D MAX	MAX.	MIN.	
10	192990-1530	2.165 (55.0)	.437 (11.1)	.740 (18.8)	3.011 (76.5)	.354 (9.0)	.165 (4.2)	PG 9
12	192990-1540	2.283 (58.0)	.535 (13.6)	.818 (20.8)	3.063 (77.8)	.366 (9.3)	.224 (5.7)	PG 11
14	192990-1550	2.559 (65.0)	.574 (14.6)	.897 (22.8)	3.366 (85.5)	.488 (12.4)	.256 (6.5)	PG 13.5
14	192900-0496	2.559 (65.0)	.574 (14.6)	.897 (22.8)	3.366 (85.5)	.488 (12.4)	.256 (6.5)	PG 13.5
16	192990-1560	2.716 (69.0)	.653 (16.6)	.972 (24.7)	3.535 (89.8)	.488 (12.4)	.256 (6.5)	PG 16
16	192900-0497	2.716 (69.0)	.653 (16.6)	.972 (24.7)	3.535 (89.8)	.488 (12.4)	.256 (6.5)	PG 16
18	192990-1570	2.874 (73.0)	.653 (16.6)	.972 (24.7)	3.661 (93.0)	.630 (16.0)	.256 (6.5)	PG 16
20	192990-1580	3.267 (83.0)	.870 (22.1)	1.252 (31.8)	4.232 (107.5)	.748 (19.0)	.362 (9.2)	PG 21
22	192990-1590	3.543 (90.0)	.870 (22.1)	1.252 (31.8)	4.507 (114.5)	.748 (19.0)	.362 (9.2)	PG 21
24	192990-1600	4.133 (105.0)	1.165 (29.6)	1.645 (41.8)	5.059 (128.5)	1.040 (26.5)	.670 (17.0)	PG 29
24	192900-0498	4.133 (105.0)	1.165 (29.6)	1.645 (41.8)	5.059 (128.5)	1.040 (26.5)	.670 (17.0)	PG 29

Shaded rows = Neptune Version - Supplied with individual wire seal

UNSEALED CABLE CLAMPS - STRAIN RELIEF AND WIRE PROTECTION

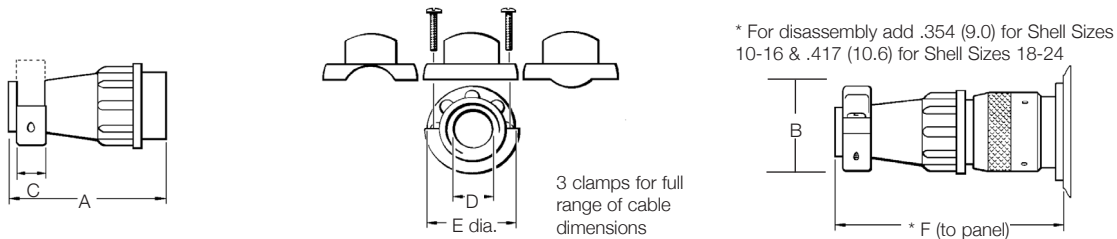

SHELL SIZE	PART #	DIMENSIONS					
		A+ .005 (.15)	B MAX	C+ .005 (.15)	D MAX	E+ .005 (.15)	F MAX
10	192922-1310	1.570 (39.9)	.846 (21.5)	.251 (6.4)	.342 (8.7)	.826 (21.0)	2.413 (61.3)
12	192922-1320	1.574 (40.0)	.980 (24.9)	.251 (6.4)	.503 (12.8)	.944 (24.0)	2.413 (61.3)
14	192922-1330	1.811 (46.0)	1.063 (27.0)	.251 (6.4)	.543 (13.8)	1.063 (27.0)	2.641 (67.1)
14	192900-0286	1.811 (46.0)	1.063 (27.0)	.251 (6.4)	.543 (13.8)	1.063 (27.0)	2.641 (67.1)
16	192922-1340	1.811 (46.0)	1.185 (30.1)	.251 (6.4)	.669 (17.0)	1.189 (30.2)	2.641 (67.1)
16	192900-0343	1.811 (46.0)	1.185 (30.1)	.251 (6.4)	.669 (17.0)	1.189 (30.2)	2.641 (67.1)
18	192990-1510	1.968 (50.0)	1.259 (32.0)	.275 (7.0)	.783 (19.9)	1.307 (33.2)	2.787 (70.8)
20	192922-1350	2.165 (55.0)	1.350 (34.3)	.275 (7.0)	.826 (21.0)	1.433 (36.4)	3.122 (79.3)
22	192922-1360	2.362 (60.0)	1.460 (37.1)	.322 (8.2)	.905 (23.0)	1.559 (39.6)	3.358 (85.3)
24	192990-1520	2.559 (65.0)	1.645 (41.8)	.322 (8.2)	1.063 (27.0)	1.685 (42.8)	3.574 (90.8)
24	192900-0344	2.559 (65.0)	1.645 (41.8)	.322 (8.2)	1.102 (28.0)	1.673 (42.5)	3.574 (90.8)

Shaded rows = Neptune Version - Supplied with individual wire seal

RINGLOCK ADAPTERS FOR HEAT SHRINK BOOTS OR SLEEVING

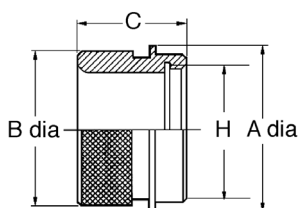

SHELL SIZE	PART #	DIMENSIONS (MAX)			
		A	B	C	H THREAD
10	192990-1430	.827 (21.0)	.712 (18.1)	.755 (19.2)	9/16-24UNEF-2B
12	192990-1440	.944 (24.0)	.921 (23.4)	.755 (19.2)	11/16-24UNEF-2B
14	192990-1450	1.063 (27.0)	.952 (24.2)	.755 (19.2)	13/16-20UNEF-2B
16	192990-1460	1.189 (30.2)	1.165 (29.6)	.846 (21.5)	15/16-20UNEF-2B
18	192990-1470	1.311 (33.3)	1.248 (31.7)	.846 (21.5)	1-1/16-18UNEF-2B
20	192990-1480	1.437 (36.5)	1.409 (35.8)	.897 (22.8)	1-3/16-18UNEF-2B
22	192990-1490	1.563 (39.7)	1.503 (38.2)	.897 (22.8)	1-5/16-18UNEF-2B
24	192990-1500	1.689 (42.9)	1.626 (41.3)	.862 (21.9)	1-7/16-18UNEF-2B

All dimensions in inches (millimeters in parentheses) unless otherwise stated.

CRIMP TOOL OPERATION

There are five different crimp tools used with Trident contacts. Find the appropriate tool on the Contact Selection Chart and follow the instructions for that tool below.

HAND CRIMP TOOL FOR STAMPED CONTACTS

(192990-3140 for 16-28 AWG contacts and 192900-0175 for 14 AWG contacts)

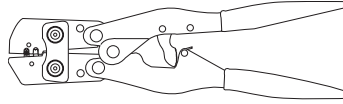

STEP 1: Strip wires to length (See strip length in Column 8 of contact chart → on page 49)

STEP 2: Open the tool and select the proper crimp cavity for the wire gauge.

STEP 3: Hold tool in your right hand with the die cavity identification facing away from you.

STEP 4: Pick up the contact by the mating end. Slip the contact into the appropriate die cavity so that the notch just behind the “gold” portion of the contact fits over the sliding plate on the lower half of the die.

STEP 5: Squeeze the handle just enough to hold the contact in the die cavity.

STEP 6: Turn the tool over in your right hand and insert the stripped wire into the contact until it bottoms.

STEP 7: Cycle the tool. The tool will not open until the contact has been completely crimped.

STEP 8: Inspect the crimp. A contact crimp verification tool is available. Please contact us.

CONTACT CRIMP TOOL

(121586-5236) (121586-5237) (121586-5238)

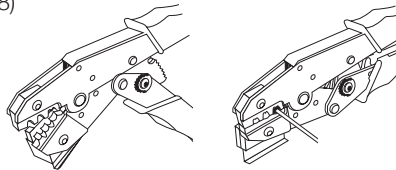

STEP 1: Strip wires to length (see strip length in Column 8 of contact chart → on page 49)

STEP 2: Open the tool and select the proper crimp cavity for the wire gauge.

STEP 3: Now hold the tool so that the cavity identification is away from you (the back side).

STEP 4: Surrounding the lower die is a holding frame; push up on the tab to fully raise the frame.

STEP 5: While holding the frame open, insert the power contact wire side first, until the lip on the contact hits against the ledge of the lower die. The U-shaped wire crimps should be upright in the die.

STEP 6: Release the tab. The frame should now be holding the contact in the proper cavity, ready to crimp.

STEP 7: Close the tool just enough to grip the contact.

STEP 8: Insert the stripped wire into the contact from the wire side.

STEP 9: Cycle the tool. The tool will not open until the contact has been completely crimped. An escape lever is located on the ratchet mechanism to release the tool if necessary.

STEP 10: Inspect the crimp. See “Stamped Contacts” in Crimp Inspection section → on page 60.

ECONOMY TOOL FOR STAMPED CONTACTS

(192922-1440)

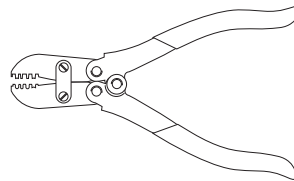

STEP 1: Strip wires to length (See strip length in Column 8 of contact chart → on page 49)

STEP 2: Select the proper crimp cavity for the wire gauge.

STEP 3: The contact itself has two U-shaped crimp areas, each requiring a separate crimp operation. The larger, rear U-shaped area crimps over the wire insulation and provides strain relief. The smaller, longer, U-shaped area crimps over the bare wire and provides the electrical connection.

STEP 4: Insert the contact into the tool so that the smaller wire crimp U is upright and centered in the proper die (the open portion of the U facing the cavity identification on the tool).

STEP 5: Close the tool just enough to firmly grip the contact.

STEP 6: Insert the stripped wire into the contact until it bottoms.

STEP 7: Cycle the tool.

STEP 8: Remove the crimped contact. Now you must crimp the insulation grip.

STEP 9: Place the insulation U upright in the die cavity marked INS. Crimp the Insulation U over the wire insulation in the same manner as the wire crimp.

STEP 10: Inspect the two crimps. See “Stamped Contacts” in Crimp Inspection section → on page 60. A contact crimp verification tool is available. Please contact us.

CRIMP TOOL FOR MACHINED CONTACTS

There are five different crimp tools used with Trident contacts. Find the appropriate tool on the Contact Selection Chart and follow the instructions for that tool below.

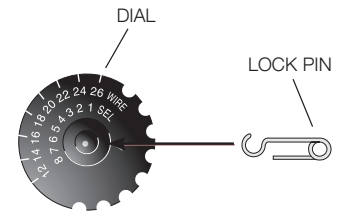
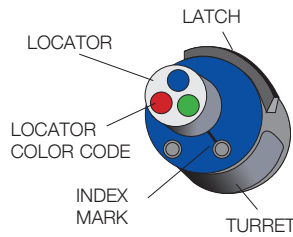
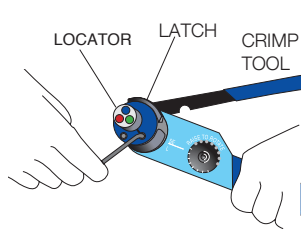

STEP 1: Strip the wires to length.

STEP 2: Open the crimp tool by squeezing the handles. Push the latch on turret to pop up the locator. Attach the turret to the crimp tool using the two captive hex bolts in the turret.

STEP 3: Select the proper locator position for your contact by rotating the locator until the proper color is aligned with the index mark. Push locator back down until it snaps into position.

STEP 4: Adjust dial for proper wire gauge. To change the dial setting, remove the lock pin and lift center of dial. Turn to the desired wire gauge. Replace lock pin on dial.

CONTACT TYPE	LOCATOR COLOR
PINS	BLUE
SOCKETS	GREEN
FIRST-MATE	RED

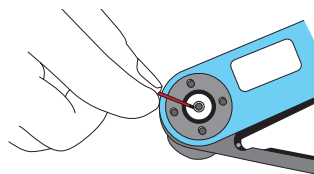
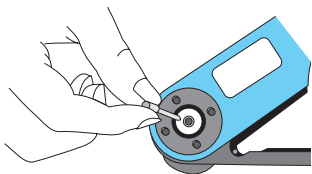

STEP 5: Cycle the tool before inserting the contact to be sure the tool is in the open position. Drop the contact, mating end first, into the crimp cavity of the tool. Squeeze the tool handle just enough to grip the contact without actually crimping it.

STEP 6: Insert the stripped wire into the contact with a slight twisting motion. Be sure all wire strands are inside the contact. Squeeze the handle to cycle the tool. The handle will not release until the contact is completely crimped.

STEP 7: Remove the crimped contact. Pull on the wire slightly to be sure it is properly crimped. Be sure the contact is not bent or damaged in any way.

STEP 8: Visually inspect the crimp. See “machined contacts” drawing in Visual Check section on next page.

NEW TRIDENT AUTOMATIC CRIMP TOOLS FOR REELED STAMPED CONTACTS

Mini Applicators modules are used in industry-standard crimp presses. This allows for fast change-over for crimping different contacts. Using the same crimp press saves valuable factory floor space over multiple presses.

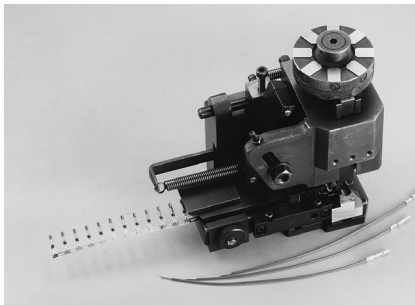

CONTACT	TYPE	MINI APPLICATOR PART NUMBER	
		METCAL	SCHAFFER
20-26	Signal	121586-5239	121586-5142
16-18	Signal	121586-5217	121586-5141
14-16	Signal	121586-5240	Contact us for details

Adjustment fixture for signal applicators 317-8675-133

CONTACT	TYPE	MINI APPLICATOR PART NUMBER
16-18	Power	193800-0031
14-16	Power	193800-0024
12-14	Power	193800-0023

Contact us for detailed crimp specifications.

CRIMP INSPECTION (MICRO SECTIONS)

Enlargement of micro section allows for final judgment of crimp quality. This test is recommended whenever new tools or new types of wire are used.

FOR STAMPED CONTACTS

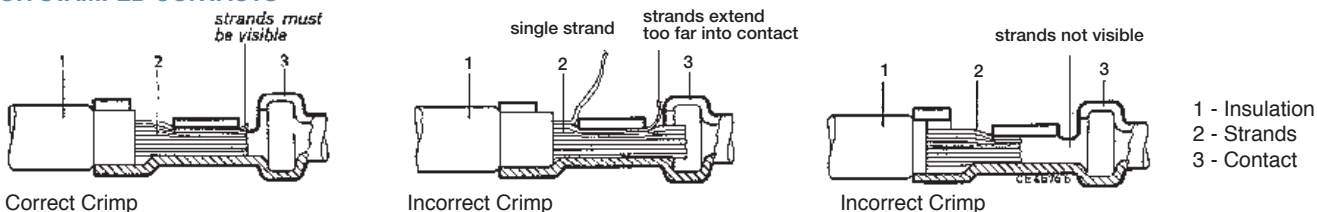

FOR MACHINED CONTACTS

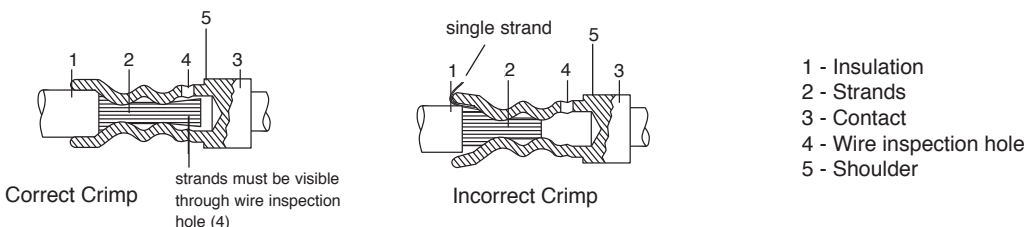

INSERTION OF CONTACTS

No insertion tool is required.

STEP 1: Strip wires to length (See strip length in Column 8 of contact chart → on page 49.)

STEP 2: When using Neptune connectors with the rear wire sealing grommet, put the grommet in place on the connector and push the contact directly through the grommet into the cavity. Start at the center of the layout and work concentrically to the outside edge to eliminate the possibility of the grommet shifting or bunching during loading.

Wire needles may be used as an assembly aid for use with high density layouts, maximum size wire insulation, or when adding to already terminated connectors.

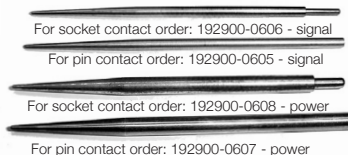

To use, push the point of the needle through the selected hole and check that it has passed through to the correct contact cavity by looking at the mating face of the connector. Once verified, attach the contact to the non-pointed end of the needle. Holding the point of the contact, push the contact into the connector body until the contact locks into place. Note: The wiring needle is used as a guide and will not pull the contact into the connector body. Be sure to inspect the mating face (see 3 below) as the grommet mutes the “feel” of the contact locking into place.

STEP 3: Inspect by looking at the mating side of the connector. Be sure that all of the contacts are on the same plane (fully inserted). If not, use the extraction tool to remove the contact and re-insert.

EXTRACTION OF CONTACTS

Contacts can be removed from the housings using the appropriate extraction tool. The tool is placed over the mating end of the contact and the sleeve is rotated slightly as it is pushed into the connector.

IMPORTANT: Make sure the depth indicating line on the tool is even with the mating face of the connector before depressing the plunger to avoid damage to connector and contact. Light pressure on the plunger then ejects the contact from the rear of the connector.

STEP 1:

Contact in connector

STEP 2:

Extraction tool compresses tines

STEP 3:

Plunger pushes contact out rear of connector

