

DESCRIPTION

The MP2005 is a micropower, ultra low-dropout LDO linear regulator. It has a 1.0V to 5.5V input voltage range and can regulate the output voltage from as low as 0.5V. The MP2005 can supply up to 800mA of load current with a typical dropout voltage of 90mV. It requires a bias supply (2.7V to 5.5V) separate from V_{IN} to run the internal reference and LDO drive circuitry. The output current comes directly from the input voltage supply for high efficiency regulation. The 0.5V internal reference voltage allows the output to be programmed to a wide range of voltages (0.5V to 4V).

A low bias current of 100 μ A makes the MP2005 ideal for use in battery-powered applications. The bias supply V_{BIAS} can be directly applied from the battery while V_{IN} is powered from the high efficiency buck regulator (or other secondary supply). This reduces output noise and the size of the decoupling capacitor.

Other features of MP2005 include thermal overload and current limit protection, stability with ultra low ESR ceramic capacitors as low as 1 μ F, and fast transient response. The MP2005 is available in a 8-pin QFN (2mm x 3mm) package.

FEATURES

- Wide 1.0V to 5.5V Input Voltage Range
- Stable with 1 μ F Ceramic Capacitor
- Ultra-Low Dropout (ULDO) voltage: 90mV@800mA
- 2% Accurate Output Voltage
- Adjustable Output Range of 0.5V to 4V
- High PSRR
 - 65dB at 1KHz
 - 48dB at 1MHz
- Better Than 0.0005%/mA Load Regulation
- Stable With Low-ESR Output Capacitors
- Low 100 μ A Ground Current
- Internal Thermal Protection
- Current Limit Protection
- 1 μ A Typical Quiescent Current at Shutdown

APPLICATIONS

- Low Current Regulators
- Low Power Handheld Devices
- Battery Powered Systems
- Cellular Phones
- Portable Electronic Equipment
- Post Regulation for Switching Power Supplies
- Power Supplies

All MPS parts are lead-free, halogen free, and adhere to the RoHS directive. For MPS green status, please visit MPS website under Quality Assurance.

"MPS" and "The Future of Analog IC Technology" are Registered Trademarks of Monolithic Power Systems, Inc.

TYPICAL APPLICATION

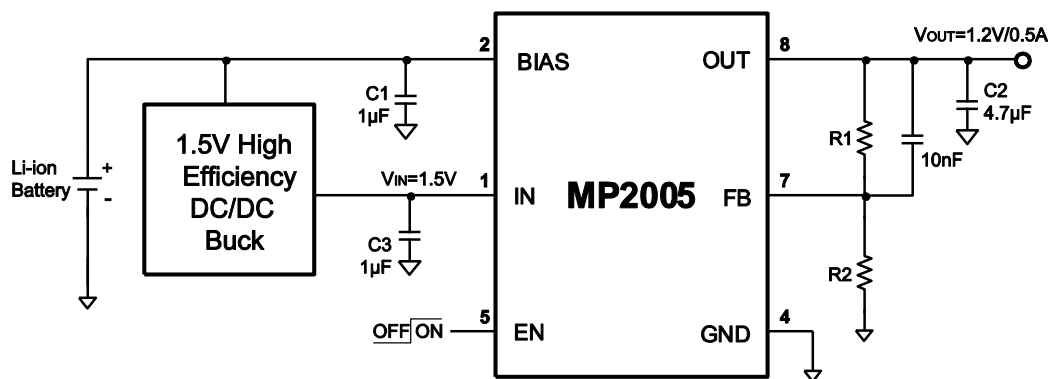

ORDERING INFORMATION

Part Number*	Package	Top Marking
MP2005DD	QFN-8 (2mm x 3mm)	See Below

* For Tape & Reel, add suffix -Z (e.g. MP2005DD-Z)
 For RoHS compliant packaging, add suffix -LF (e.g. MP2005DD-LF-Z)

TOP MARKING

N3YW
LLL

N3: product code of MP2005DD;
 Y: year code;
 W: week code;
 LLL: lot number;

PACKAGE REFERENCE

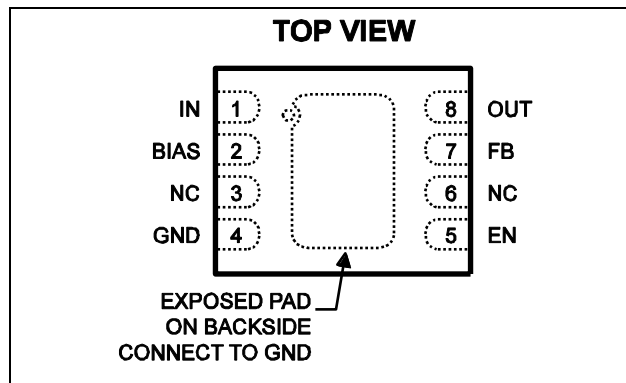

ABSOLUTE MAXIMUM RATINGS ⁽¹⁾

V_{BIAS}, V_{IN} to GND	-0.3V to +6V
FB, EN to GND	-0.3V to 6V
OUT	-0.3V to 6V
Continuous Power Dissipation ($T_A = +25^\circ\text{C}$) ⁽²⁾	2.3W
Junction Temperature	150°C
Lead Temperature	260°C
Storage Temperature	-65°C to +150°C

Recommended Operating Conditions ⁽³⁾

Input Voltage V_{IN}	1.0V to 5.5V
Input Voltage V_{BIAS}	2.7V to 5.5V
Output Voltage	0.5V to 4.0V
Load Current	800mA Maximum
Operating Temperature	-40°C to +85°C

Thermal Resistance ⁽⁴⁾	θ_{JA}	θ_{JC}
QFN-8 (2mm x 3mm)	55	12 ... °C/W

Notes:

- 1) Exceeding these ratings may damage the device.
- 2) The maximum allowable power dissipation is a function of the maximum junction temperature $T_J(\text{MAX})$, the junction-to-ambient thermal resistance θ_{JA} , and the ambient temperature T_A . The maximum allowable continuous power dissipation at any ambient temperature is calculated by $P_D(\text{MAX}) = (T_J(\text{MAX}) - T_A) / \theta_{JA}$. Exceeding the maximum allowable power dissipation will cause excessive die temperature, and the regulator will go into thermal shutdown. Internal thermal shutdown circuitry protects the device from permanent damage.
- 3) The device is not guaranteed to function outside of its operating conditions.
- 4) Measured on JESD51-7, 4-layer PCB.

ELECTRICAL CHARACTERISTICS

$V_{IN} = 1.5V$, $V_{BIAS} = 3.6V$, $V_{OUT} = 1.2V$, $C2 = 4.7\mu F$, $C3 = 1\mu F$, $T_A = +25^\circ C$, unless otherwise noted.

Parameter	Symbol	Condition	Min	Typ	Max	Units
V_{IN} Operating Voltage			1.0		5.5	V
V_{BIAS} Operating Voltage			2.7		5.5	V
V_{IN} Operating Current		$V_{OUT} = 1.2V$		4	10	μA
V_{BIAS} Operating Current		$I_{OUT} = 10\mu A$, $V_{OUT} = 1.2V$		100	150	μA
FB Regulation Voltage		$I_{OUT} = 1mA$ to $800mA$	0.490	0.500	0.510	V
		$-40^\circ C \leq T_A \leq +85^\circ C$, $V_{OUT} = 0.5V$	0.487	0.500	0.512	
Dropout Voltage		$I_{OUT} = 800mA$, $V_{BIAS} = 3.6V$		70	90	mV
V_{IN} Line Regulation		$I_{OUT} = 1mA$, $V_{IN} = 1.0V$ to $5.5V$ $V_{BIAS} = 3.6V$ $V_{OUT} = 0.5V$		0.002		%/V
V_{BIAS} Line Regulation		$I_{OUT} = 100mA$, $V_{BIAS} = 2.7V$ to $5.5V$ $V_{OUT} = 0.5V$ $V_{IN} = 1.5V$		0.04		%/V
Load Regulation		$I_{OUT} = 1mA$ to $800mA$		0.0005		%/mA
PSRR		$V_{IN} > V_{OUT} + 0.5V$, $C2 = 10\mu F$, $V_{IN}(AC) = 100mV$, $f = 1MHz$		48		dB
EN Input High Voltage			1.3			V
EN Input Low Voltage					0.8	V
EN Input Bias Current		$V_{EN} = 1.2V$	-1		+1	μA
Thermal Protection				155		$^\circ C$
Thermal Protection Hysteresis				30		$^\circ C$
GND Current		$I_{LOAD} = 500mA$		110	150	μA

PIN FUNCTIONS

Pin #	Name	Description
1	IN	Power Source Input. Bypass IN to GND with a $1\mu F$ or greater capacitor.
2	BIAS	Bias Voltage. Bypass to GND with a $1\mu F$ capacitor (or greater)
3, 6	NC	No Connect.
4	GND	Ground.
5	EN	Enable Input. Drive EN high to turn on the MP2005, drive EN low to turn it off. For automatic startup, connect EN to Bias or VIN, and make sure EN voltage $\geq 1.3V$.
7	FB	Feedback Input. Connect a resistive voltage divider from OUT to FB to set the output voltage. OUT feedback threshold is $0.5V$.
8	OUT	Regulator Output. OUT is the output of the linear regulator. Bypass OUT to GND with a $1\mu F$ or greater capacitor.

TYPICAL PERFORMANCE CHARACTERISTICS

$C1=C3=2.2\mu\text{F}$, $C2=4.7\mu\text{F}$, $V_{\text{EN}}=V_{\text{BIAS}}=3.6\text{V}$, $T_{\text{A}}=25^{\circ}\text{C}$, unless otherwise noted

Voltage Dropout

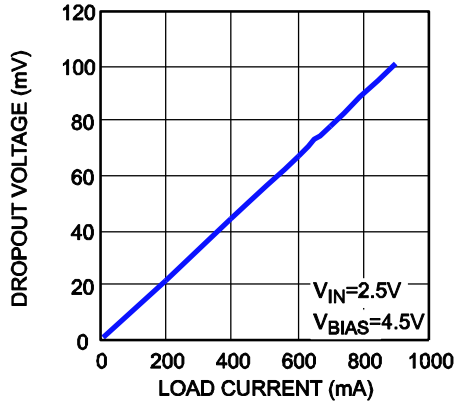

PSRR vs. Frequency

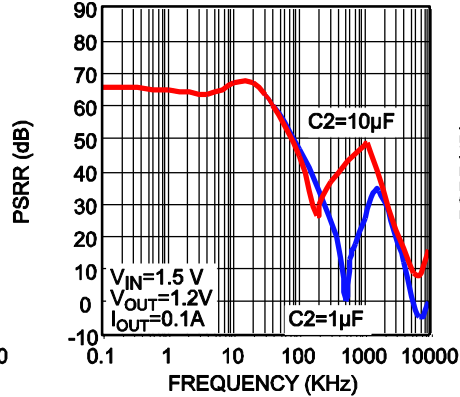

PSRR vs. V_{IN}

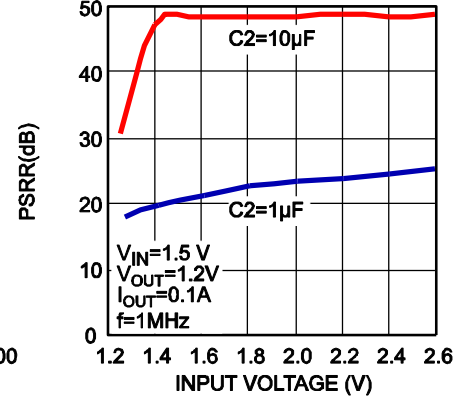

Line Regulation

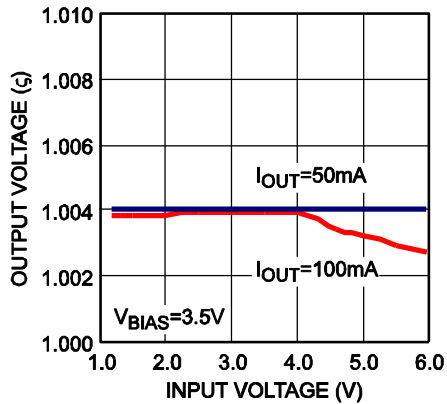

Line Regulation

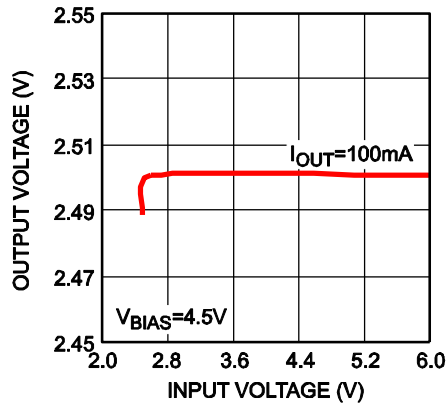

Line Regulation

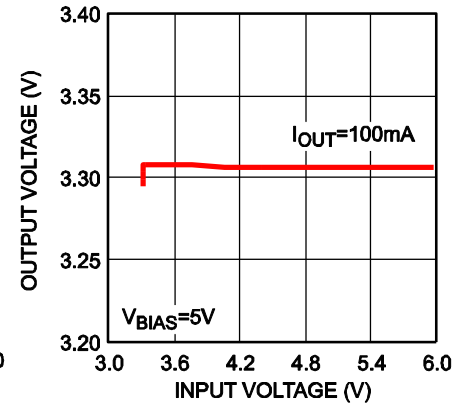

Load Regulation

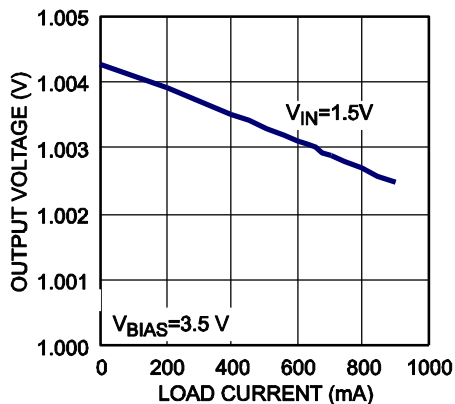

Load Regulation

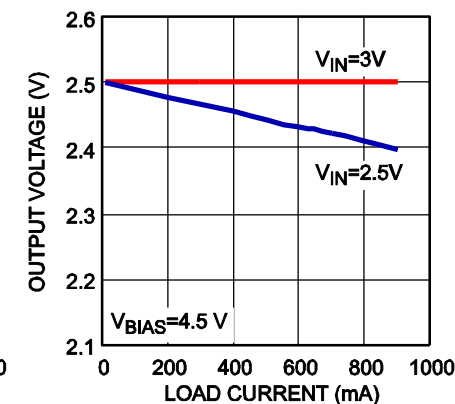

Load Regulation

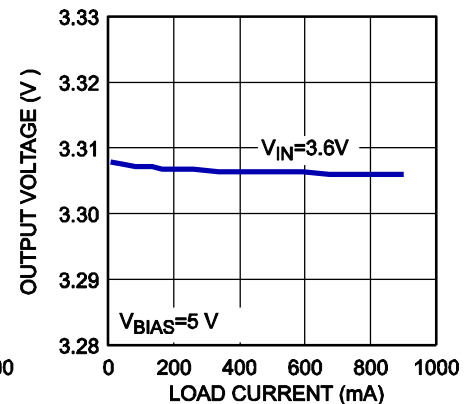

TYPICAL PERFORMANCE CHARACTERISTICS *(continued)*

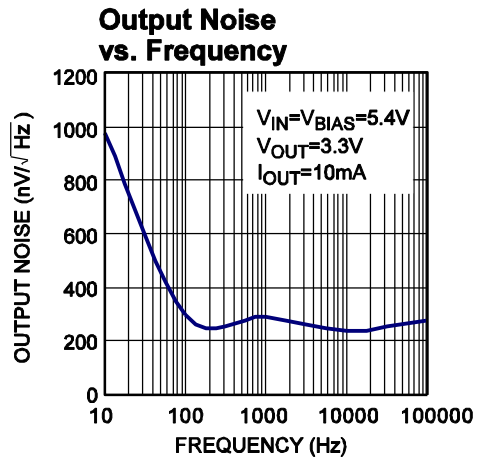
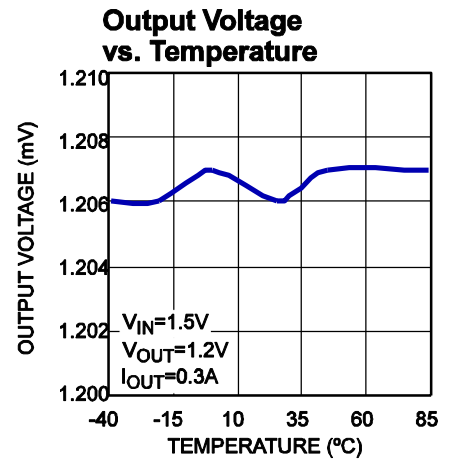
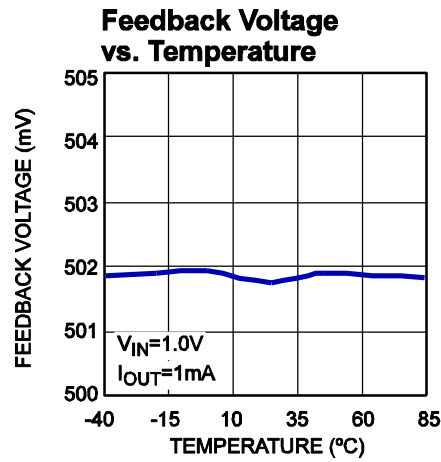
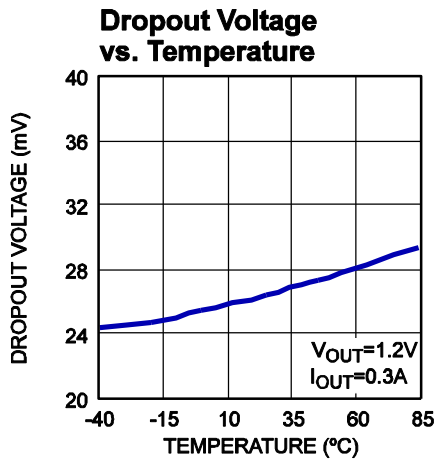
 C1=C3=2.2uF, C2=4.7uF, $V_{EN}=V_{BIAS}=3.6V$, $T_A=25^\circ C$, unless otherwise noted

TYPICAL PERFORMANCE CHARACTERISTICS *(continued)*

 C1=C3=2.2uF, C2=4.7uF, $V_{EN}=V_{BIAS}=3.6V$, $V_{IN}=3.6V$, $T_A=25^{\circ}C$, unless otherwise noted

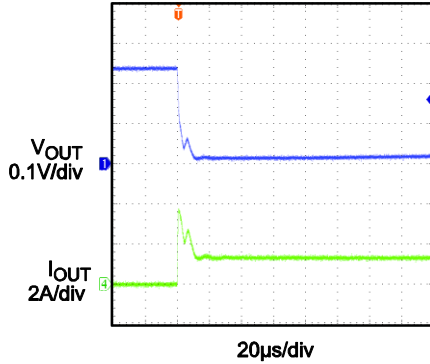
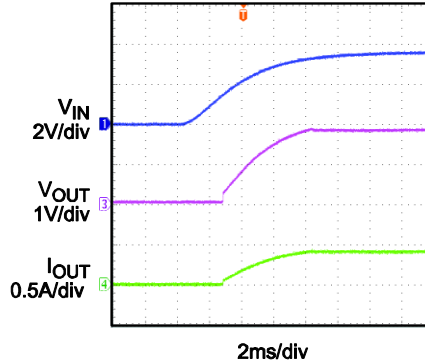
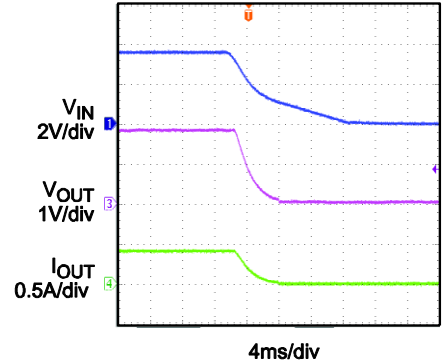
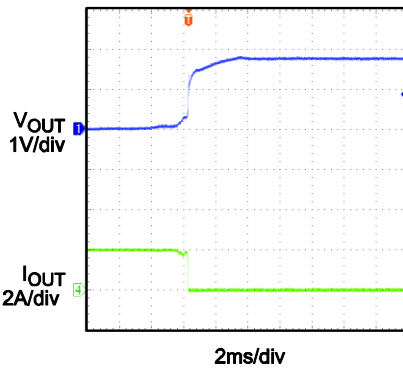
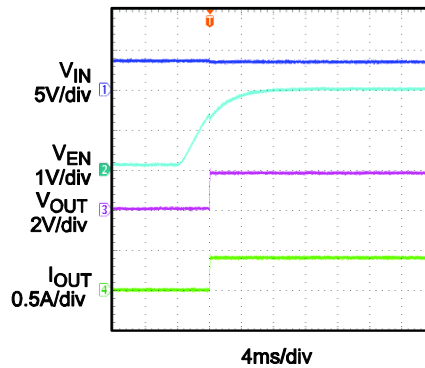
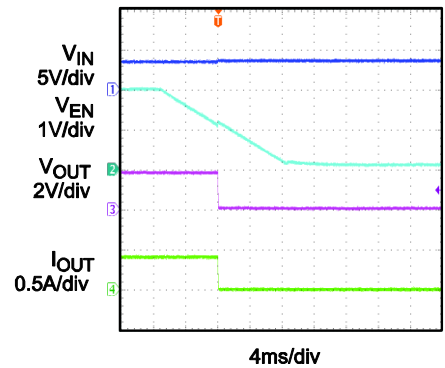
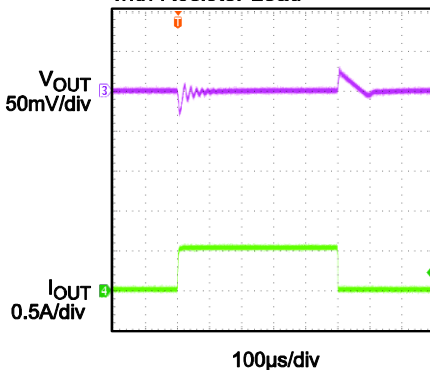
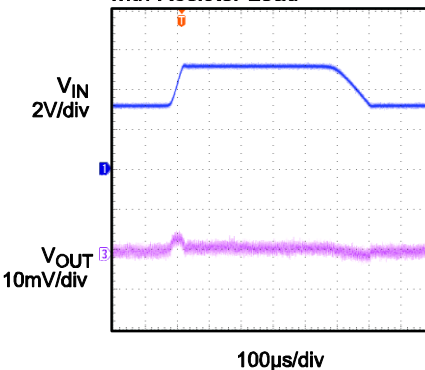
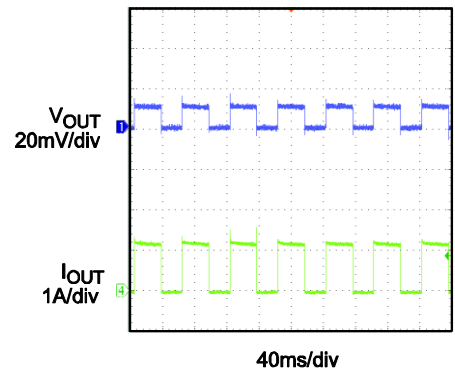
Short Circuit
 $V_{IN}=2V$, $V_{OUT}=1.8V$

Power Ramp Up
 $V_{OUT}=1.8V$, $I_{OUT}=420mA$,
with Resistor Load

Power Ramp Down
 $V_{OUT}=1.8V$, $I_{OUT}=420mA$
with Resistor Load

Short Circuit Recovery
 $V_{IN}=2V$, $V_{OUT}=1.8V$

Enable Turn On
 $V_{OUT}=1.8V$, $I_{OUT}=400mA$
with Resistor Load

Enable Turn Off
 $V_{OUT}=1.8V$, $I_{OUT}=400mA$
with Resistor Load

Load Transient
 $V_{BIAS}=2.9V$, $V_{OUT}=1.2V$, $V_{IN}=1.5V$,
 $I_{OUT}=20mA$ to $600mA$,
with Resistor Load

Line Transient
 $V_{IN}=3.5V$ to $5.2V$, $V_{OUT}=1.2V$,
 $I_{OUT}=100mA$
with Resistor Load

Thermal Protection
 $V_{OUT}=1.8V$, $I_{OUT}=1A$
with Resistor Load

BLOCK DIAGRAM

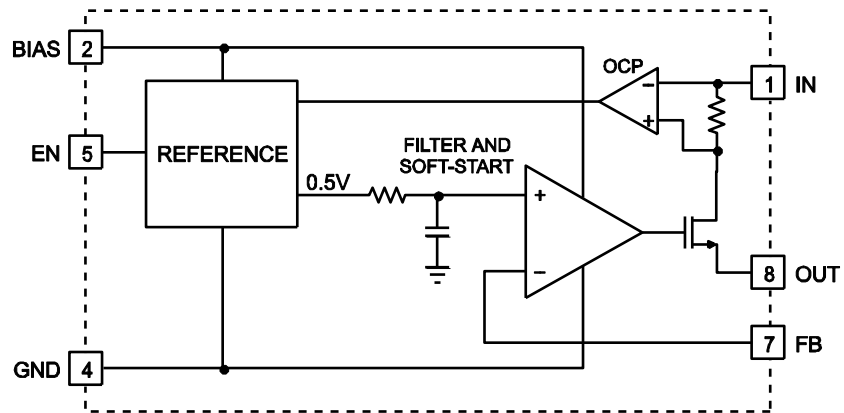

Figure 1—Block Diagram of Super Low Dropout Regulator

APPLICATION INFORMATION

Setting the Output Voltage

The MP2005 has an adjustable output voltage, set by using a resistive voltage divider from the output voltage to FB pin. The voltage divider divides the output voltage down to the feedback voltage by the ratio:

$$V_{FB} = V_{OUT} \frac{R2}{R1 + R2}$$

Where V_{FB} is the feedback threshold voltage ($V_{FB} = 0.5V$), and V_{OUT} is the output voltage.

Thus the output voltage is:

$$V_{OUT} = 0.5 \times \frac{R1 + R2}{R2}$$

R2 can be as high as 100kΩ, but a typical value is 10kΩ. Using that value, R1 is determined by:

$$R1 = R2 \times \left(\frac{V_{OUT} - V_{FB}}{V_{FB}} \right)$$

For example, for a 1.8V output voltage, R2 is 10kΩ, and R1 is 26kΩ. You can select a standard 26kΩ ($\pm 1\%$) resistor for R1.

The following table lists the selected R1 for various output voltages.

Table 1—Adjustable Output Voltages R1 Values

V _{OUT} (V)	R1 (kΩ)	R2 (kΩ)
1.25	15	10
1.5	20	
1.8	26	
2	30	
2.5	40	
2.8	46	
3	50	
3.3	56	
4	70	

Bias Input

The bias input is designed for low drop application. The bias pin must be at least 2.7V, and at least 1.5V higher than the output. If V_{IN} supply voltage meets these requirements, the bias pin can be tied to V_{IN} .

Feed Forward Capacitor

Feed forward capacitor which a ceramic type capacitor parallels with R1 affects loop stability. According to actual application, MP2005 improves load transient performance by add a suitable feed forward capacitor.

PCB Layout Guide

PCB layout is very important to achieve good regulation, ripple rejection, transient response and thermal performance. It is highly recommended to duplicate EVB layout for optimum performance.

If change is necessary, please follow these guidelines and take Figure 2 for reference.

- 1) Input and output bypass ceramic capacitors are suggested to be put close to the IN Pin and OUT Pin respectively.
- 2) Ensure all feedback connections are short and direct. Place the feedback resistors and compensation components as close to the chip as possible.
- 3) Connect IN, OUT and especially GND respectively to a large copper area to cool the chip to improve thermal performance and long-term reliability.

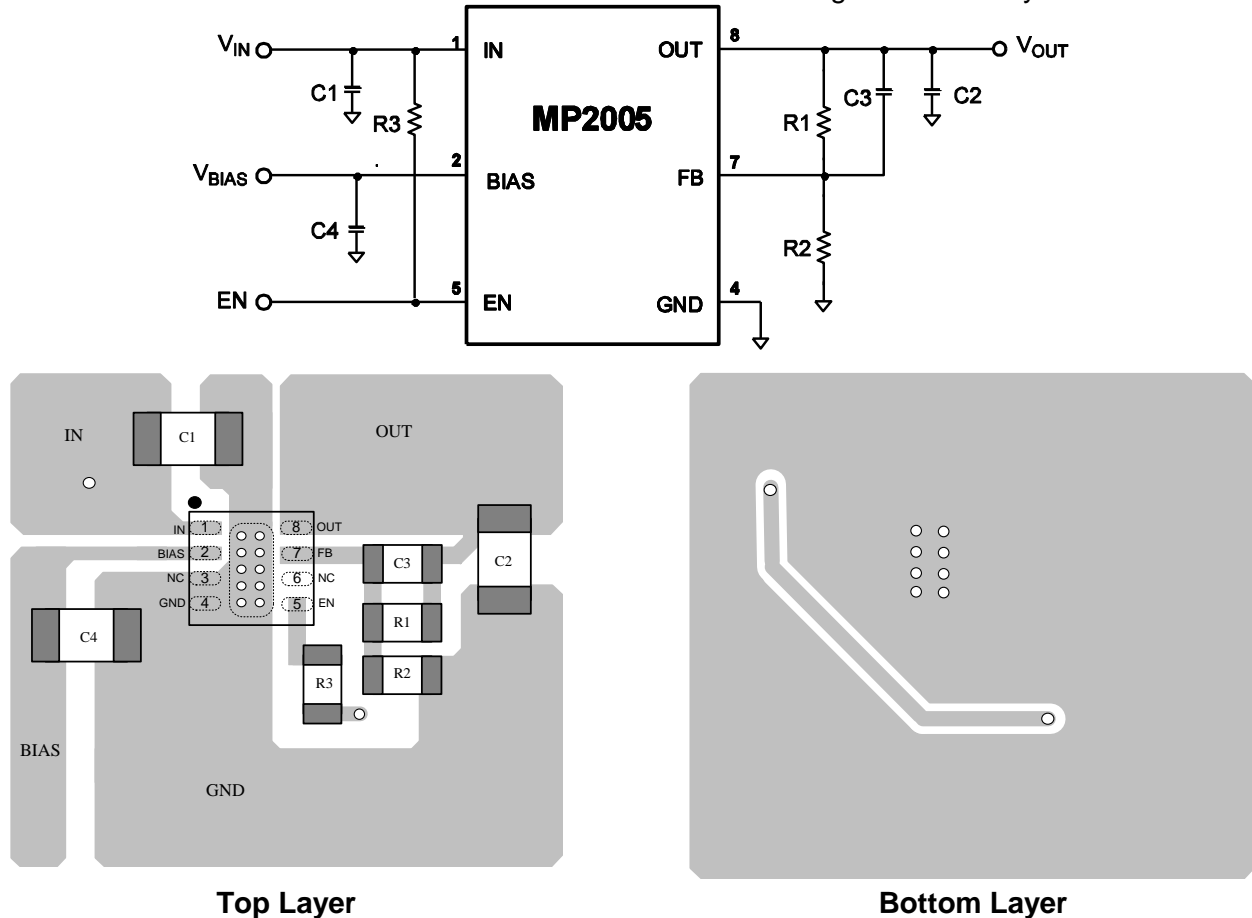
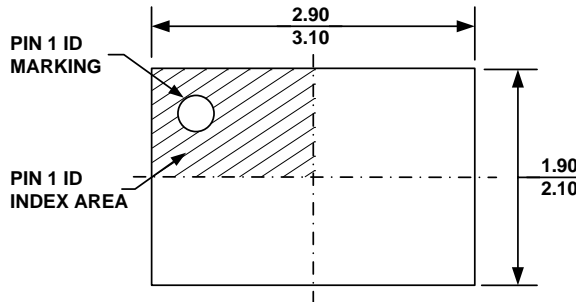

Figure 2—PCB Layout

PACKAGE INFORMATION

QFN8 (2mm x 3mm)



TOP VIEW

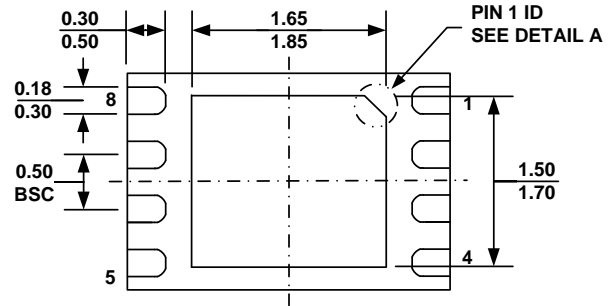

BOTTOM VIEW

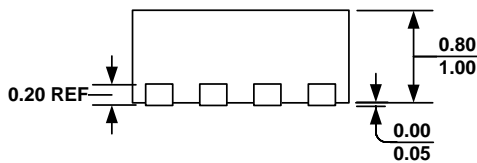

SIDE VIEW

PIN 1 ID OPTION A
0.30x45 °TYP.

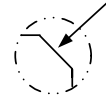

PIN 1 ID OPTION B
R0.20 TYP.

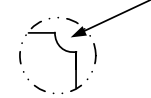

DETAIL A

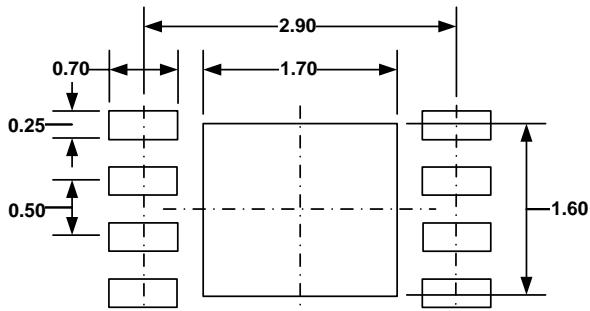

RECOMMENDED LAND PATTERN

NOTE:

- 1) ALL DIMENSIONS ARE IN MILLIMETERS.
- 2) EXPOSED PADDLE SIZE DOES NOT INCLUDE MOLD FLASH.
- 3) LEAD COPLANARITY SHALL BE 0.08 MILLIMETER MAX.
- 4) DRAWING CONFORMS TO JEDEC MO-229, VARIATION VCED-2.
- 5) DRAWING IS NOT TO SCALE.