

**Generation Y Connector System**

TE Internal #: 2035363-4

Housing for Female Terminals, Wire-to-Board / Wire-to-Device / Wire-to-Wire, 6 Position, 2.54 mm [.1 in] Centerline, Generation Y Connector System

[View on TE.com >](#)

Connectors &gt; Automotive Connectors &gt; Automotive Housings

Connector System: **Wire-to-Board, Wire-to-Device, Wire-to-Wire**Number of Positions: **6**Connector & Housing Type: **Housing for Female Terminals**Centerline (Pitch): **2.54 mm [.1 in]**Sealable: **No****Features****Product Type Features**

Mixed & Hybrid Connector	No
Connector Shape	Rectangular
Connector System	Wire-to-Board, Wire-to-Device, Wire-to-Wire
Connector & Housing Type	Housing for Female Terminals
Sealable	No
Primary Locking Feature	Integrated in Housing

**Configuration Features**

Number of Positions	6
Number of Rows	1

**Body Features**

Cable Exit Angle	180°
Primary Product Color	Black
Connector & Keying Code	B

**Contact Features**

Contact Size	.64mm
Contact Type	Receptacle
Mating Tab Width	.64 mm[.025 in]



### Mechanical Attachment

Terminal Position Assurance	Yes
Strain Relief	Without
Mating Alignment Type	Keyed
Mating Alignment	With
Connector Mounting Type	Cable Mount (Free-Hanging)

### Housing Features

Housing Material	PA GF
Centerline (Pitch)	2.54 mm [.1 in]

### Dimensions

Connector Height	13.5 mm [.531 in]
Product Width	18.5 mm [.728 in]
Product Length	20.2 mm [.795 in]
Row-to-Row Spacing	6 mm [.236 in]

### Usage Conditions

Operating Temperature (Max)	70 °C, 75 °C, 80 °C, 85 °C, 90 °C, 100 °C [158 °F][167 °F][176 °F][185 °F][194 °F][212 °F]
Operating Temperature Range	-40 – 100 °C [-40 – 212 °F]

### Operation/Application

Circuit Application	Signal
---------------------	--------

### Packaging Features

Packaging Quantity	1000
Packaging Method	Package

### Other

Serviceable	Yes
Connector Position Assurance Capable	Yes

### Product Compliance

[For compliance documentation, visit the product page on TE.com>](#)

EU RoHS Directive 2011/65/EU	Compliant
EU ELV Directive 2000/53/EC	Compliant
China RoHS 2 Directive MIIT Order No 32, 2016	No Restricted Materials Above Threshold



EU REACH Regulation (EC) No. 1907/2006

Current ECHA Candidate List: JUNE 2024 (241)

Candidate List Declared Against: JUNE 2024 (241)

Does not contain REACH SVHC

Halogen Content

Low Halogen - Br, Cl, F, I < 900 ppm per homogenous material. Also BFR/CFR/PVC Free

Solder Process Capability

Not applicable for solder process capability

Product Compliance Disclaimer

This information is provided based on reasonable inquiry of our suppliers and represents our current actual knowledge based on the information they provided. This information is subject to change. The part numbers that TE has identified as EU RoHS compliant have a maximum concentration of 0.1% by weight in homogenous materials for lead, hexavalent chromium, mercury, PBB, PBDE, DBP, BBP, DEHP, DIBP, and 0.01% for cadmium, or qualify for an exemption to these limits as defined in the Annexes of Directive 2011/65/EU (RoHS2). Finished electrical and electronic equipment products will be CE marked as required by Directive 2011/65/EU. Components may not be CE marked. Additionally, the part numbers that TE has identified as EU ELV compliant have a maximum concentration of 0.1% by weight in homogenous materials for lead, hexavalent chromium, and mercury, and 0.01% for cadmium, or qualify for an exemption to these limits as defined in the Annexes of Directive 2000/53/EC (ELV). Regarding the REACH Regulation, the information TE provides on SVHC in articles for this part number is based on the latest European Chemicals Agency (ECHA) 'Guidance on requirements for substances in articles' posted at this URL: <https://echa.europa.eu/guidance-documents/guidance-on-reach>

### Compatible Parts



TE Part # 2035334-2  
CONTACT,FEMALE0.64, 18 AWG



TE Part # 1924955-2  
CONTACT,FEMALE0.64,18AWG, UNSEALED



TE Part # 1456968-2  
CONTACT,FEMALE, 0.64, 18 AWG, AG

### Also in the Series | Generation Y Connector System



Automotive Connector Caps & Covers (21)



Automotive Housings(157)



Automotive Terminals(46)



Connector Seals & Cavity Plugs(6)



Insertion & Extraction Tools(1)



PCB Headers & Receptacles(19)

## Customers Also Bought



TE Part #2309644-3  
MQS, CONNECTOR HOUSING

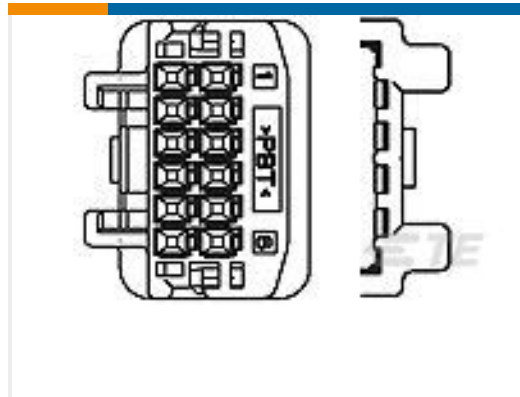

TE Part #1565804-1  
025 G 8POS CAP ASSY W TO W

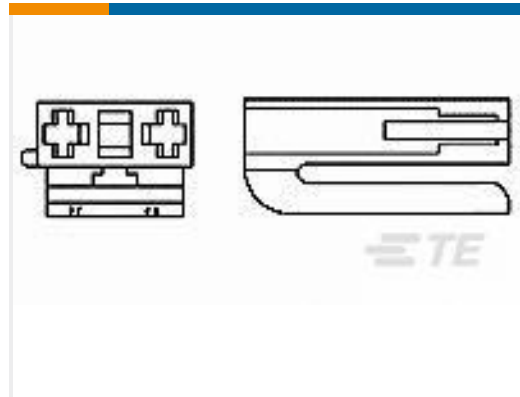

TE Part #623346-1  
2P CONNECTOR HOUSING



TE Part #2272163-1  
MCON WIRE DRESS, 4P, RIGHT ANGLE



TE Part #2035363-6  
1X6 GENERATION Y ASSY KEYD CPA

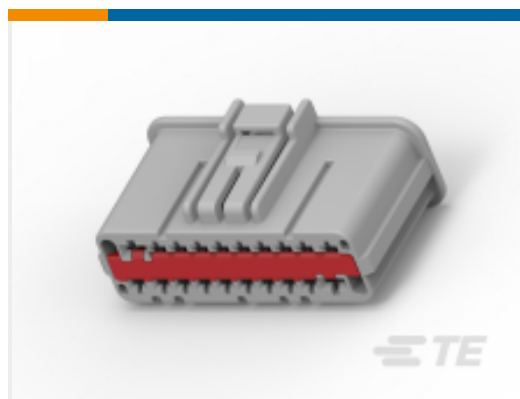

TE Part #2098377-2  
20P PLUG ASSEMBLY UNSEALED HYBRID B-KEY



TE Part #1-2332470-1  
4POS, HYBRID, REC HSG ASSY, SLD, COD A



TE Part #2425741-1  
2POS, AMP MCP 2.8K, REC HSG ASSY, SLD



TE Part #2310000-1  
10POS, MQS, REC HSG ASSY, UNSLD, COD A

## Documents

### Product Drawings

1X6 GENERATION Y ASSY KEYC CPA

English

### CAD Files

3D PDF

3D

### Customer View Model

ENG\_CVM\_CVM\_2035363-4\_A.2d\_dxf.zip



English

**Customer View Model**

[ENG\\_CVM\\_CVM\\_2035363-4\\_A.3d\\_igs.zip](#)

English

**Customer View Model**

[ENG\\_CVM\\_CVM\\_2035363-4\\_A.3d\\_stp.zip](#)

English

By downloading the CAD file I accept and agree to the [Terms and Conditions](#) of use.

**Product Specifications**

[Application Specification](#)

English