

MOVHE

Radial leaded high energy metal oxide varistor



Product features

- Excellent surge current suppression
- Low leakage current
- 7, 10, 14, 20 mm disk type
- Encapsulation UL94-V0
- UL 1449 edition 4
IEC 61051-1/2
- Wide operating voltage range V_{RMS} 130 V to 680 V

Applications

- Smart meters
- Surge protective devices
- Uninterruptible power supplies (UPS)
- Power distribution with integrated surge protection
- Power supplies and power converters
- Appliances

Agency information

- cURus: E340782 per UL1449
- TUV: J 50562664, J 50562779



Environmental compliance



Ordering part number

MOVHE 07 V130 Y -AP

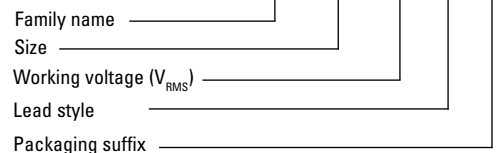

Ordering part number

- Blank (bulk)
- AP (Ammo pack)



Powering Business Worldwide

Electrical characteristics (+25 °C)

Part number	Varistor voltage ¹ @ 1 mA (V)	Max. operating voltage		Max. clamping voltage		Max. surge current 8/20 μs 1 time (A)	Rated power (W)	Max. capacitance @ 1 KHz (pF)	Max. energy (10/1000 μs) (J)	T max. (mm)	cURus	TUV
		V _{RMS} (V)	V _{DC} (V)	I _p (8/20 μs) (A)	V _p (V)							
MOVHE07V130	200	130	170	10	340	1750	0.25	250	17	4		
MOVHE07V140	220	140	180	10	360	1750	0.25	230	19	4		
MOVHE07V150	240	150	200	10	395	1750	0.25	210	21	4		
MOVHE07V175	270	175	225	10	455	1750	0.25	185	24	4.5		
MOVHE07V190	300	190	250	10	500	1750	0.25	165	26	4.5		
MOVHE07V210	330	210	275	10	550	1750	0.25	150	28	4.5		
MOVHE07V230	360	230	300	10	595	1750	0.25	140	32	4.5		
MOVHE07V250	390	250	320	10	650	1750	0.25	130	35	5		
MOVHE07V275	430	275	350	10	710	1750	0.25	115	40	5		
MOVHE07V300	470	300	385	10	775	1750	0.25	105	42	5		
MOVHE07V320	510	320	415	10	845	1750	0.25	100	45	5.5		
MOVHE07V350	560	350	460	10	925	1750	0.25	90	49	5.5		
MOVHE07V385	620	385	505	10	1025	1750	0.25	80	55	6		
MOVHE07V420	680	420	560	10	1120	1750	0.25	75	60	6		
MOVHE07V510	820	510	670	10	1355	1750	0.25	60	73	6.5		
MOVHE10V130	200	130	170	25	340	3500	0.4	500	35	4.5	√	√
MOVHE10V140	220	140	180	25	360	3500	0.4	450	39	4.5	√	√
MOVHE10V150	240	150	200	25	395	3500	0.4	420	42	4.5	√	√
MOVHE10V175	270	175	225	25	455	3500	0.4	370	49	5	√	√
MOVHE10V190	300	190	250	25	500	3500	0.4	330	54	5	√	√
MOVHE10V210	330	210	275	25	550	3500	0.4	300	58	5	√	√
MOVHE10V230	360	230	300	25	595	3500	0.4	280	65	5	√	√
MOVHE10V250	390	250	320	25	650	3500	0.4	260	70	5	√	√
MOVHE10V275	430	275	350	25	710	3500	0.4	230	80	5.5	√	√
MOVHE10V300	470	300	385	25	775	3500	0.4	210	85	5.5	√	√
MOVHE10V320	510	320	415	25	845	3500	0.4	200	90	6	√	√
MOVHE10V350	560	350	460	25	925	3500	0.4	180	92	6	√	√
MOVHE10V385	620	385	505	25	1025	3500	0.4	160	95	6.5	√	√
MOVHE10V420	680	420	560	25	1120	3500	0.4	150	98	6.5	√	√
MOVHE10V460	750	460	615	25	1240	3500	0.4	130	100	6.5	√	√
MOVHE10V510	820	510	670	25	1355	3500	0.4	120	110	7	√	√
MOVHE10V550	910	550	745	25	1500	3500	0.4	110	130	7.5	√	√
MOVHE10V625	1000	625	825	25	1650	3500	0.4	100	140	7.5	√	√
MOVHE14V130	200	130	170	50	340	6000	0.6	1000	70	4.5	√	√
MOVHE14V140	220	140	180	50	360	6000	0.6	900	78	4.5	√	√
MOVHE14V150	240	150	200	50	395	6000	0.6	830	84	4.5	√	√
MOVHE14V175	270	175	225	50	455	6000	0.6	740	99	5	√	√
MOVHE14V190	300	190	250	50	500	6000	0.6	670	108	5	√	√
MOVHE14V210	330	210	275	50	550	6000	0.6	610	115	5	√	√
MOVHE14V230	360	230	300	50	595	6000	0.6	560	130	5	√	√
MOVHE14V250	390	250	320	50	650	6000	0.6	510	140	5	√	√
MOVHE14V275	430	275	350	50	710	6000	0.6	460	155	5.5	√	√
MOVHE14V300	470	300	385	50	775	6000	0.6	430	175	5.5	√	√
MOVHE14V320	510	320	415	50	845	6000	0.6	390	180	6	√	√

Electrical characteristics (+25 °C)

Part number	Varistor voltage ¹	Max. operating voltage		Max. clamping voltage		Max. surge current 8/20 μ s 1 time (A)	Rated power (W)	Max. capaci- tance @ 1 KHz (pF)	Max. energy (10/1000 μ s) (J)	T max. (mm)	cURus	TUV
	@ 1 mA (V)	V _{RMS} (V)	V _{DC} (V)	I _p (8/20 μ s) (A)	V _p (V)							
MOVHE14V350	560	350	460	50	925	6000	0.6	360	185	6	√	√
MOVHE14V385	620	385	505	50	1025	6000	0.6	320	190	6.5	√	√
MOVHE14V420	680	420	560	50	1120	6000	0.6	290	200	6.5	√	√
MOVHE14V460	750	460	615	50	1240	6000	0.6	270	210	6.5	√	√
MOVHE14V510	820	510	670	50	1355	6000	0.6	240	235	7	√	√
MOVHE14V550	910	550	745	50	1500	6000	0.6	220	255	7.5	√	√
MOVHE14V625	1000	625	825	50	1650	6000	0.6	200	280	7.5	√	√
MOVHE20V130	200	130	170	100	340	10000	1	2000	140	5		
MOVHE20V140	220	140	180	100	360	10000	1	1800	155	5		
MOVHE20V150	240	150	200	100	395	10000	1	1650	168	5		
MOVHE20V175	270	175	225	100	455	10000	1	1500	190	5		
MOVHE20V190	300	190	250	100	500	10000	1	1300	210	5		
MOVHE20V210	330	210	275	100	550	10000	1	1200	228	5.5		
MOVHE20V230	360	230	300	100	595	10000	1	1100	255	5.5		
MOVHE20V250	390	250	320	100	650	10000	1	1000	275	5.5		
MOVHE20V275	430	275	350	100	710	10000	1	930	305	6		
MOVHE20V300	470	300	385	100	775	10000	1	850	350	6		
MOVHE20V320	510	320	415	100	845	10000	1	780	360	6		
MOVHE20V350	560	350	460	100	925	10000	1	710	380	6.5		
MOVHE20V385	620	385	505	100	1025	10000	1	650	390	7		
MOVHE20V420	680	420	560	100	1120	10000	1	600	400	7		
MOVHE20V460	750	460	615	100	1240	10000	1	530	420	7.5		
MOVHE20V485	780	485	640	100	1290	10000	1	510	440	7.5		
MOVHE20V510	820	510	670	100	1355	10000	1	500	460	7.5		
MOVHE20V550	910	550	745	100	1500	10000	1	440	510	8		
MOVHE20V625	1000	625	825	100	1650	10000	1	400	565	8		
MOVHE20V680	1100	680	895	100	1815	10000	1	360	620	8.5		

1. Varistor voltage tolerance: $\pm 10\%$

2. Leakage current (@75% of varistor voltage @ 1 mA) : $\leq 20\mu$ A

Dimensions- mm

Drawing not to scale

Y kink

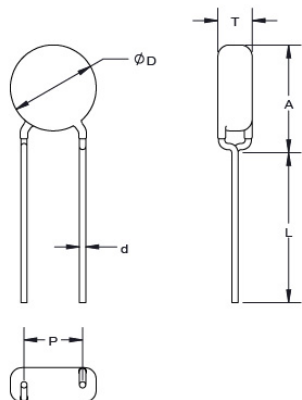

Family	D max	T max	P	d	L (Bulk)	L (Ammo)	A max
MOVHE07	9.0		5.0±0.5	0.6±0.5	3.5±0.5	17.5±1	14.0
MOVHE10	12.5	See Electrical characteristics table	7.5±0.5	0.8±0.5	3.5±0.5	17.5±1	18.0
MOVHE14	16.5		7.5±0.5	0.8±0.5	3.5±0.5	17.5±1	22.5
MOVHE20	22.5		10.0±0.5	1.0±0.5	3.5±0.5	17.5±1	31.0

*Tin covered copper clad steel

Part marking

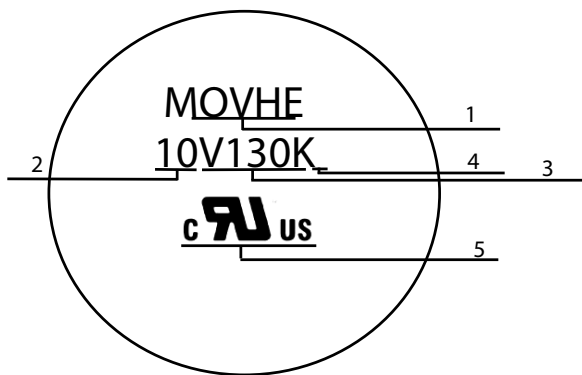

Item	Description	Content
1	Family name	MOVHE
2	Body size	07, 10, 14, 20
3	V_{RMS}	V130 = 130 Vac
4	V_{1mA} tolerance code	K = ±10%
5	Certification logo	cURus

General specifications

Operating temperature		-40 °C to +125 °C
Lead pull strength	IEC 60068-2-21	Gradually applying the force specified and keeping the unit fixed for 10±1 sec. 0.5 < d ≤0.8 10 N 0.8< d ≤1.25 20 N
Lead bending strength	IEC 60068-2-21	Hold specimen and apply the force specified below to each lead. Bend the specimen to 90°, then return to the original position. Repeat the procedure in the opposite direction. 0.5 < d ≤0.8 5 N 0.8< d ≤1.25 10 N
Vibration	IEC 60068-2-6	Frequency range: 10 to 55 Hz Amplitude: 0.75 mm Direction: 3 mutually perpendicular directions, 2 hours each.
Solderability	IEC 60068-2-20	+245 ± 3 °C , 3 ± 0.3 second
Resistance to welding heat	IEC 60068-2-20	+260 ± 3 °C , 10 ± 1 second
Dielectric strength	IEC 61051-1	The two ends of the sample are connected together as an electrode, and the epoxy encapsulation body surrounding the sample with a metal ball is another electrode, and the voltage is applied for 2 minutes at 2500 V _{AC} .
Damp heat test	IEC 60068-2-78	+40 ± 2 °C , 90 to 95% RH , 1344 hours
Temperature cycling test	IEC 60068-2-14	The temperature abrupt change cycled for 5 cycles according to the following conditions.
		Step Temperature °C Time (minute)
		1 -40±3 30±3
		2 +25±5 5±3
		3 +125±2 30±3
4 +25±5 5±3		
High temperature load test	MIL-STD-202 Method 108	+125±2 °C, 1000±24 hours, at VDC (Maximum operating voltage)

V-I characteristics curves

MOVHE07V130~510

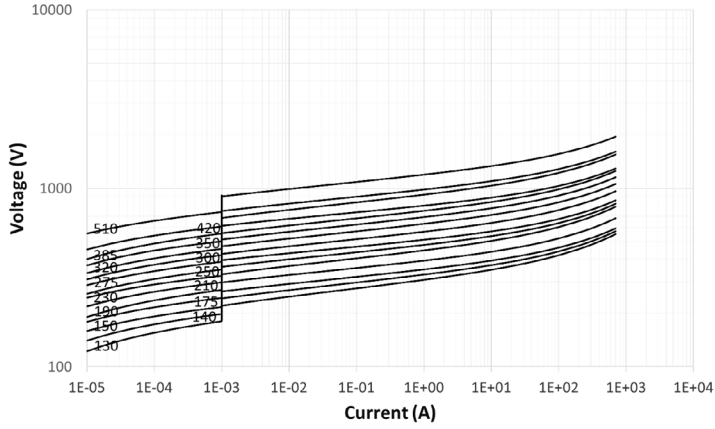

MOVHE10V130~625

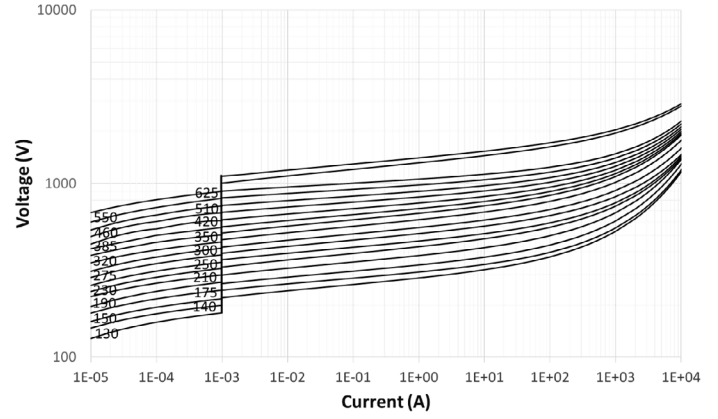

MOVHE14V130~625

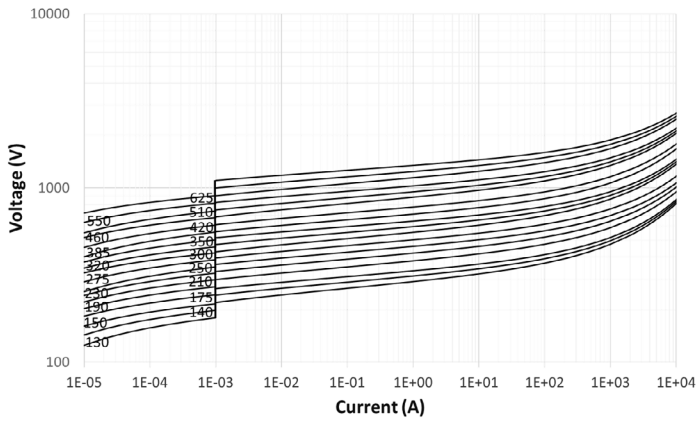

MOVHE20V130~680

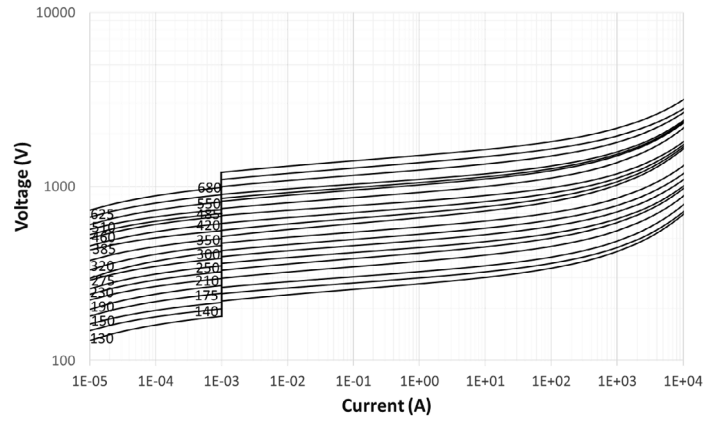

Pulse rating curves

MOVHE07V130~510

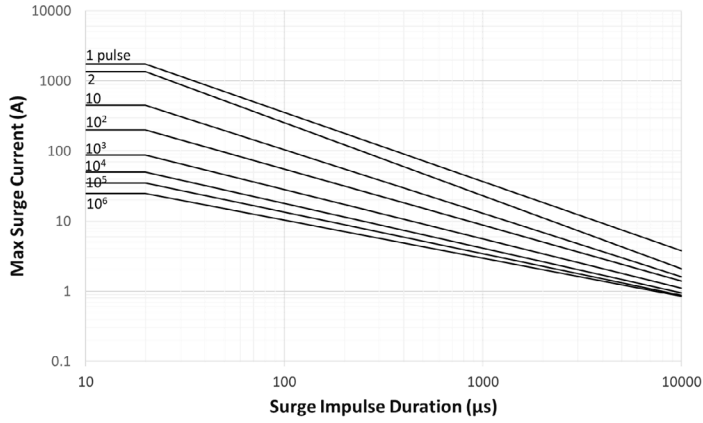

MOVHE10V130~625

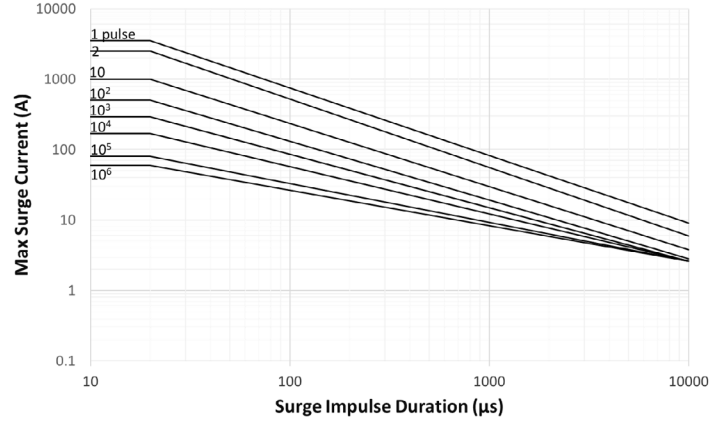

MOVHE14V130~625

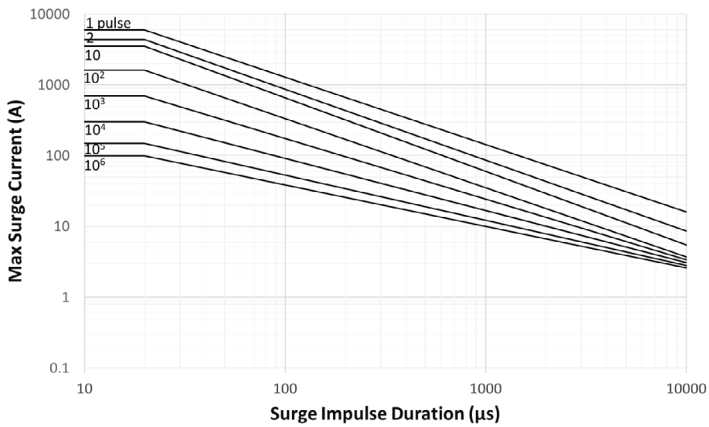

MOVHE20V130~680

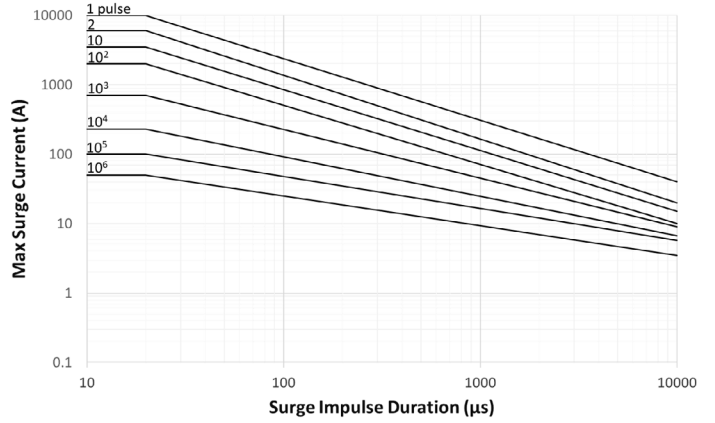

Packaging information

Quantity

Part number	Bulk (pcs/bag)	Inner box	Shipping box	Ammo/box	Shipping box
MOVHE07V130-250	1000	2000	16000	1,500	7500
MOVHE07V 275-350	1000	2000	16000	1,250	6250
MOVHE07V385-510	800	1600	12800	1,250	6250
MOVHE10V130-250	500	1000	8000	1,000	5000
MOVHE10V275-420	500	1000	8000	1000	5000
MOVHE10V460-625	400	800	6400	800	4000
MOVHE14V130-250	250	500	4000	500	2000
MOVHE14V275-320	250	500	4000	500	2000
MOVHE14V350-420	200	400	3200	500	2000
MOVHE14V460-625	200	400	3200	400	1600
MOVHE20V130-250	100	200	1600	500	2000
MOVHE20V275-320	100	200	1600	500	2000
MOVHE20V350-420	100	200	1600	500	2000
MOVHE20V460-625	50	100	800	300	1200
MOVHE20V680	50	100	800	300	1200

Ammo pack dimension - mm

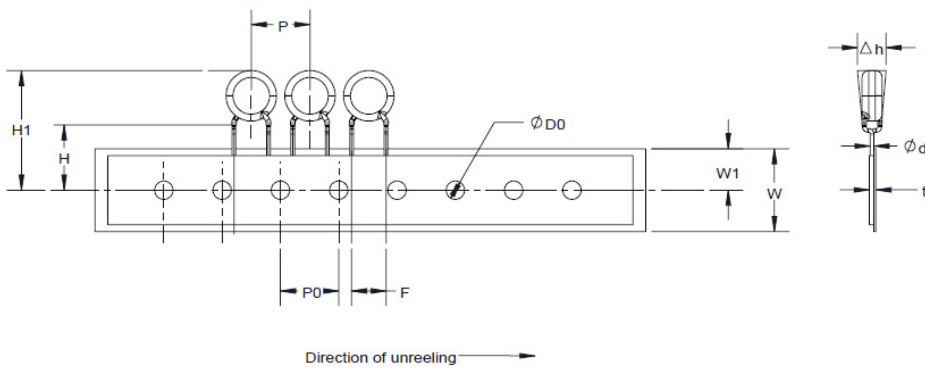

Dimension	Tolerance	MOVHE07	MOVHE10	MOVHE14	MOVHE20
F	±0.5	5	7.5	8	10
P	±1.0	12.7	12.7	25	25.4
P0	±1.0	12.7	12.7	13	12.7
Δh	Max	2	2	2	2
W	±1.0	18	18	18	18
W1	±0.5	9	9	9	9
D0	±0.2	4	4	4	4
d	±0.05	0.6	0.8	0.8	1
H	±1.0	17.5	17.5	17.5	17.5
H1	Max	32.5	36.5	41	49.5
t	±0.2	0.5	0.5	0.5	0.5

Wave solder profile

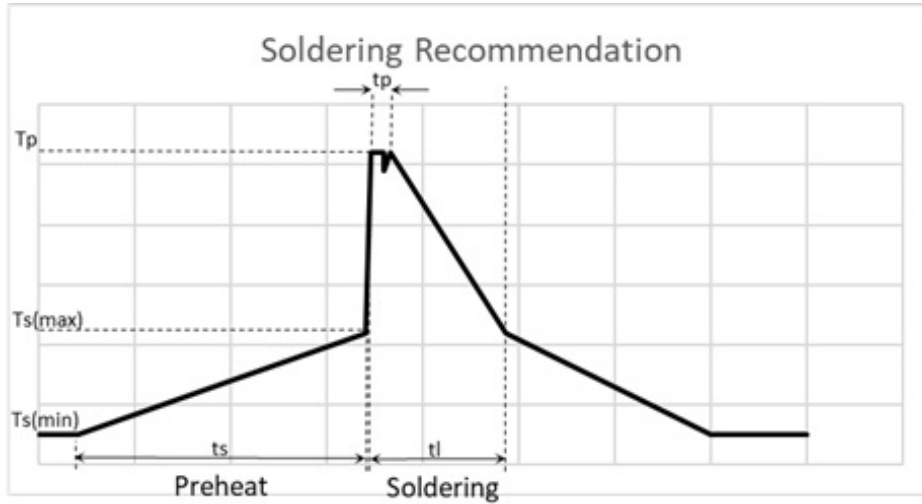

Profile feature		Lead (Pb) free solder
Preheat	$T_s(\max)$	130 °C ± 20 °C
	$T_s(\min)$	Room temperature
	t_s	30 to 90 seconds
Soldering	T_p	260 °C maximum
	t_p	< 10 seconds
	Ramp-down rate	3.5 °C/second maximum

Manual solder

+360 °C (3 seconds maximum by soldering iron, distance from varistor 2 mm minimum), generally manual/hand soldering is not recommended.

Life Support Policy: Eaton does not authorize the use of any of its products for use in life support devices or systems without the express written approval of an officer of the Company. Life support systems are devices which support or sustain life, and whose failure to perform, when properly used in accordance with instructions for use provided in the labeling, can be reasonably expected to result in significant injury to the user.

Eaton reserves the right, without notice, to change design or construction of any products and to discontinue or limit distribution of any products. Eaton also reserves the right to change or update, without notice, any technical information contained in this bulletin.

Eaton
Electronics Division
1000 Eaton Boulevard
Cleveland, OH 44122
United States
Eaton.com/electronics

© 2023 Eaton
All Rights Reserved
Printed in USA
Publication No. ELX1288 BU-ELX22151
January 2023

Eaton is a registered trademark.

All other trademarks are property of their respective owners.

Follow us on social media to get the latest product and support information.

