

QPL and COTS Equivalent

MIL-DTL-38999 Series III

Industry-Standard • Military / Aerospace • Harsh-Environment

SEPTEMBER 2016



QPL AND COTS EQUIVALENT MIL-DTL-38999 Series III

The industry standard mil/aero connector backed with Glenair service and availability

Standard environmental-class MIL-DTL-38999 Series III connectors with DLA certification are now manufactured and supplied by Glenair. These industry-standard connectors are ideally suited for the broad range of harsh environmental land, sea, air, and space applications and are backed with Glenair's industry leading service, support, and availability. Marked with D38999 or Glenair COTS part numbering, these environmental crimp-contact connectors are available in cable plug or mounted jam nut / square flange receptacle shell styles. All standard material and finish classes are supported including W (Cad/O.D. over Electroless Nickel), F (Electroless Nickel), T (Nickel-PTFE) and G (Space-Grade Electroless Nickel). Other RoHS-compliant finishes including Glenair ZR (Black Zinc-Nickel) are also available under Glenair commercial part numbers. Contact arrangements per MIL-STD-1560 and all standard and normal and alternate polarizations are fully supported. Best of all, defense and commercial aerospace customers, as well as land and marine engineers and procurement specialists may now specify these mission-critical interconnects directly from Glenair—the recognized service, support, and availability leader for the interconnect industry.

**DLA QPL MIL-DTL-38999
SERIES III NOW AVAILABLE
FROM GLENAIR**

- Qualified environmental plug, jam nut, and square flange receptacles
- All 1560 crimp-contact insert arrangements fully supported
- W, F, T and G plating classes, plus Glenair COTS equivalents
- A 100% made in America interconnect: No foreign-sourced materials, component parts, or assembly labor employed



Glenair: Made in America since 1956

MIL-DTL-38999 Series III

Industry standard harsh environment connectors



MECHANICAL, ENVIRONMENTAL, AND ELECTRICAL PERFORMANCE

MIL-DTL-38999 Series III (Glenair Series 233-105) offers outstanding interconnect performance for mission-critical military and commercial applications.

- **Electromagnetic compatibility (EMC):** metal-to-metal coupling, plug grounding fingers, and conductive shell finishes deliver excellent shielding performance up to 65 dB at 10 GHz
- **Contact protection:** scoop-proof design prevents inadvertent damage to pin contacts during mating
- **Environmental performance:** interfacial and wire grommet seals deliver IP67 level sealing, even at high altitude
- **Corrosion resistance:** connector shell finishes—from Cad over Nickel to Class T Nickel-PTFE offer outstanding corrosion resistance
- **Mating:** triple-start stub ACME threads provide fast mating and resist galling and cross-threading
- **Anti-Decoupling:** better-than-QPL vibration and shock performance
- **Supported contacts:** from size #22D signal to #12 shielded Coax
- **Advanced COTS versions:** high-performance series (Glenair SuperNine®) available for improved durability, ease of termination, EMI/RFI filtering and more

CONNECTOR FINISH CLASSES



Electroless Nickel
 Conductivity +++++
 Corrosion Resistance ⌘⌘⌘⌘
 -65° to +200°C
 Glenair Code **ME**
 D38999 Class **F**



Space-Grade Electroless Nickel
 Conductivity +++++
 Corrosion Resistance ⌘⌘⌘⌘
 -65° to +200°C
 Glenair Code **MA**
 D38999 Class **G**



Cadmium
 Conductivity +++++
 Corrosion Resistance ⌘⌘⌘⌘⌘
 -65° to +175°C
 Glenair Code **NF**
 D38999 Class **W**



Nickel-PTFE
 Conductivity +++++
 Corrosion Resistance ⌘⌘⌘⌘⌘
 -65° to +175°C
 Glenair Code **MT**
 D38999 Class **T**



Black Zinc Nickel
 Conductivity +++++
 Corrosion Resistance ⌘⌘⌘⌘
 -65° to +175°C
 Glenair Code **ZR**
 D38999 Class **Z***



*qualification pending

SUPPORTED CRIMP-CONTACT SHELL STYLES

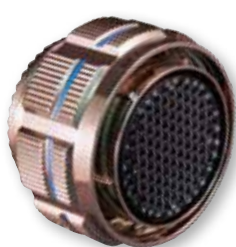

Plug

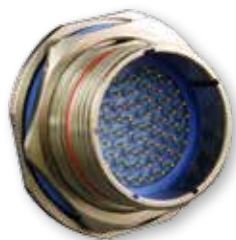

Jam Nut Receptacle







Square Flange Receptacle

Mechanical Performance Features
Threaded Triple-Start Coupling Design
Nine Shell Sizes, Range 9 – 25
Scoop-Proof Shell Design
Full Mate Visual Indicator
Integrated Contact Retention System
Interfacial and Grommet Seals
Fully Shielded
Lightning Strike
Shell-to-Shell Bottoming
Threaded/Toothed Accessory Interface
Full Range of Assembly Tools

MIL-DTL-38999 Series III

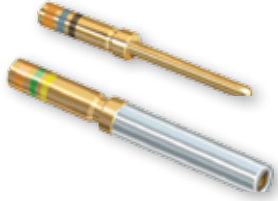

MIL-STD-1560 contact arrangements Reference information

Available Series 233-105 and D38999 Contact Arrangements*							
Contact	Number of Contacts					233-105	D38999
	#23	#22D	#20	#16	#12		
Size #23 High-Density (HD) 5 Amp Max. Current #22-#28 AWG 	19					11-23	
	32					13-23	
	55					15-23	
	73					17-23	
	88					19-23	
	121					21-23	
	151					23-23	
	187					25-23	
Size #22D 5 Amp Max. Current #22-#24 AWG 		6				9-35	A35
		13				11-35	B35
		22				13-35	C35
		37				15-35	D35
		55				17-35	E35
		66				19-35	F35
		67				19-45	F45
		79				21-35	G35
		100				23-35	H35
		128				25-35	J35
Size #20 7.5 Amp Max. Current #20-#24 AWG 			3			9-98	A98
			4			11-4	B4
			5			11-5	B5
			6			11-98	B98
			7			11-99	B99
			8			13-8	C8
			10			13-98	C98
			18			15-18	D18
			19			15-19	D19
			26			17-26	E26
			32			19-32	F32
			24			21-24	G24
			25			21-25	G25
			27			21-27	G27
			41			21-41	G41
			32			23-32	H32
		34			23-34	H34	
		36			23-36	H36	
		53			23-53	H53	
		55			23-55	H55	
		61			25-61	J61	
Size #16 Contacts 13 Amp Max. Current #16-#20 AWG 				2		11-2	B2
				4		13-4	C4
				5		15-5	D5
				8		17-8	E8
				11		19-11	F11
				16		21-16	G16
				21		23-21	H21
				16		23-97	H97
				11		23-99	H99
				29		25-29	J29
Size #12 Contacts 23 Amp Max. Current #12-14 AWG 					6	17-6	E6
					11	21-11	G11
					19	25-19	J19

*Only contact arrangements specifically listed in the D38999 column are currently QPL'd

MIL-DTL-38999 Series III



MIL-STD-1560 contact arrangements - pin front view Reference information

Contact Legend

#22D • #16 ⊕
#20 ⊖ #12 ◐

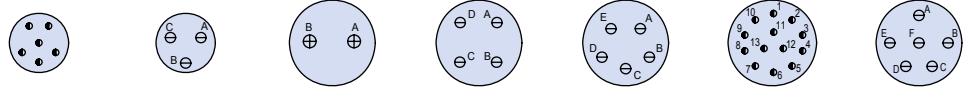

Insert Arrangement	233-105 D38999	9-35 A35	9-98 A98	11-2 B2	11-4 B4	11-5 B5	11-35 B35	11-98 B98
No. of Contacts		6	3	2	4	5	13	6
Contact Size		#22D	#20	#16	#20	#20	#22D	#20
Service Rating		M	I	I	I	I	M	I

Contact Legend

#22D • #16 ⊕
#20 ⊖ #12 ◐

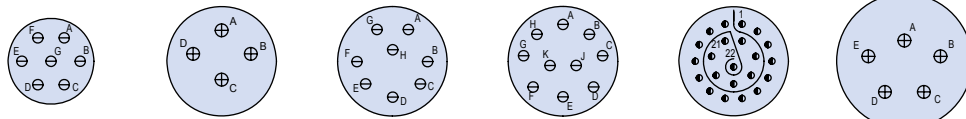

Insert Arrangement	233-105 D38999	11-99 B99	13-4 C4	13-8 C8	13-98 C98	13-35 C35	15-5 D5
No. of Contacts		7	4	8	10	22	5
Contact Size		#20	#16	#20	#20	#22D	#16
Service Rating		I	I	I	I	M	II

Contact Legend

#22D • #16 ⊕
#20 ⊖ #12 ◐

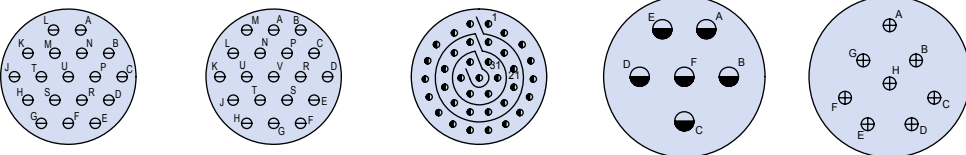

Insert Arrangement	233-105 D38999	15-18 D18	15-19 D19	15-35 D35	17-6 E6	17-8 E8
No. of Contacts		18	19	37	6	8
Contact Size		#20	#20	#22D	#12	#16
Service Rating		I	I	M	I	II

Contact Legend

#22D • #16 ⊕
#20 ⊖ #12 ◐

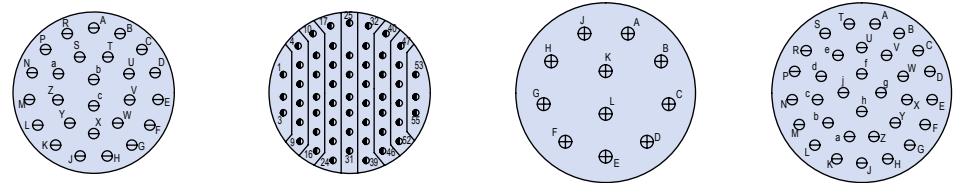

Insert Arrangement	233-105 D38999	17-26 E26	17-35 E35	19-11 F11	19-32 F32
No. of Contacts		26	55	11	32
Contact Size		#20	#22D	#16	#20
Service Rating		I	M	II	I

Contact Legend

#22D • #16 ⊕
#20 ⊖ #12 ◐

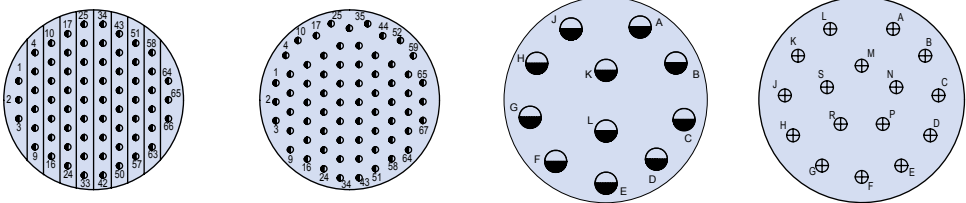

Insert Arrangement	233-105 D38999	19-35 F35	19-45 F45	21-11 G11	21-16 G16
No. of Contacts		66	67	11	16
Contact Size		#22D	#22D	#12	#16
Service Rating		M	M	I	II

MIL-DTL-38999 Series III



MIL-STD-1560 contact arrangements - pin front view Reference information

Contact Legend

#22D • #16 ⊕
#20 ⊖ #12 ●

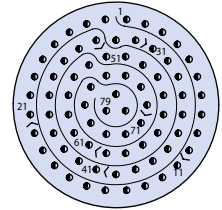
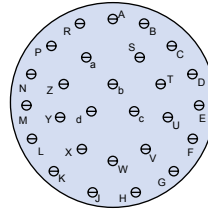
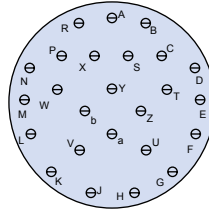
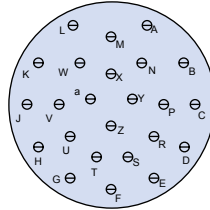

Insert Arrangement	233-105 D38999	21-24 G24	21-25 G25	21-27 G27	21-35 G35
No. of Contacts		24	25	27	79
Contact Size		#20	#20	#20	#22D
Service Rating		I	I	I	M

Contact Legend

#22D • #16 ⊕
#20 ⊖ #12 ●

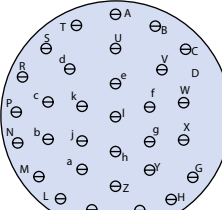
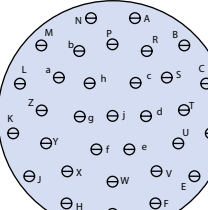
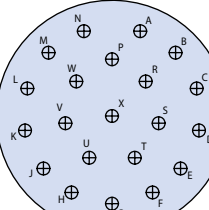
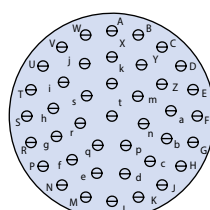

Insert Arrangement	233-105 D38999	21-41 G41	23-21 H21	23-32 H32	23-34 H34
No. of Contacts		41	21	32	34
Contact Size		#20	#16	#20	#20
Service Rating		I	II	I	I

Contact Legend

#22D • #16 ⊕
#20 ⊖ #12 ●

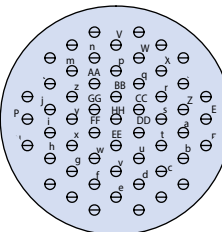
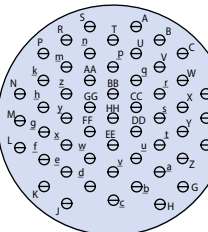
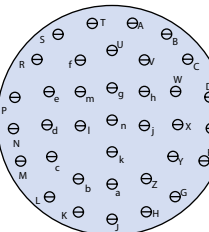
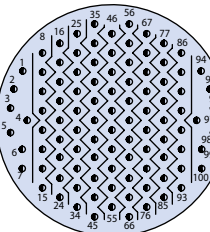

Insert Arrangement	233-105 D38999	23-35 H35	23-36 H36	23-53 H53	23-55 H55
No. of Contacts		100	36	53	55
Contact Size		#22D	#20	#20	#20
Service Rating		M	I	I	I

Contact Legend

#22D • #16 ⊕
#20 ⊖ #12 ●

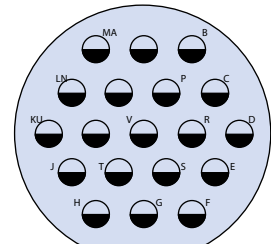
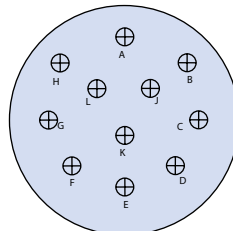
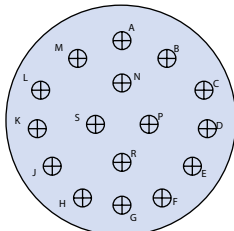

Insert Arrangement	233-105 D38999	23-97 H97	23-99 H99	25-19 J19
No. of Contacts		16	11	19
Contact Size		#16	#16	#12
Service Rating		I	II	I

MIL-DTL-38999 Series III



MIL-STD-1560 contact arrangements - pin front view Reference information

Contact Legend
 #22D • #16 ⊕
 #20 ⊖ #12 ●

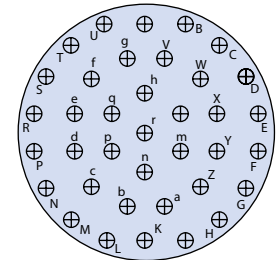
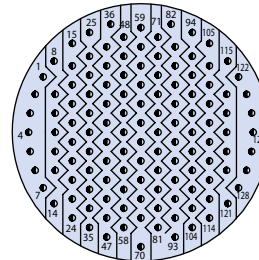
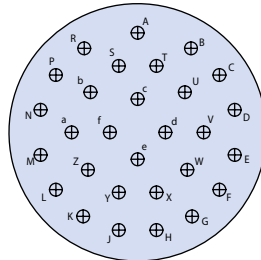

Insert Arrangement	233-105 D38999	25-29 J29	25-35 J35	25-37 J37
No. of Contacts		29	128	37
Contact Size		#16	#22D	#16
Service Rating		I	M	II

Contact Legend
 #22D • #16 ⊕
 #20 ⊖ #12 ●

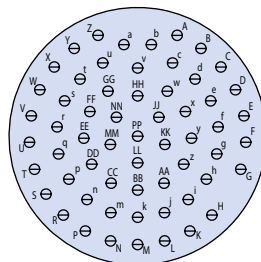

Insert Arrangement	233-105 D38999	25-61 J61
No. of Contacts		61
Contact Size		#20
Service Rating		I

Voltage Rating	Suggested Operating Voltage		Test Voltage AC RMS 60Hz							
	(Sea Level)		Sea Level		50,000 Ft.		70,000 Ft.		100,000 Ft	
Service Rating	AC (RMS)	DC	unmated	mated	unmated	mated	unmated	mated	unmated	mated
M	400	550	1300	1300	550	800	350	800	200	800
N	300	450	1000	1000	400	600	260	600	200	600
I	600	850	1800	1800	600	1000	400	1000	200	1000
II	900	1250	2300	2300	800	1000	500	1000	200	1000

Note: The establishment of electrical safety factors is left entirely to the designer, as he is in the position to know exactly what peak voltages, switching currents, transients, etc. can be expected in a particular circuit

MIL-DTL-38999 Series III



MIL-STD-1560* high density arrangements - pin front view Reference information

Contact Legend
 #22D • #16 ⊕
 #20 ⊖ #12 ◐

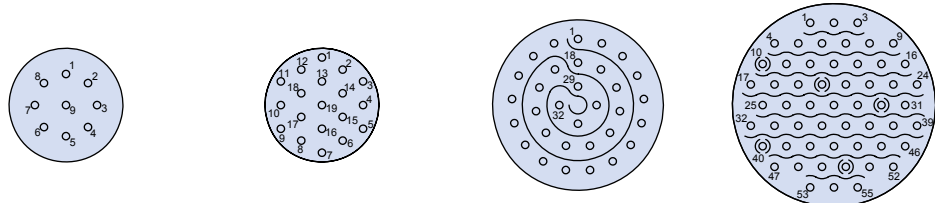

Insert Arrangement	233-105 D38999	09-23	11-23	13-23	15-23
No. of Contacts		9	19	19	55
Contact Size		#23	#23	#23	#23
Service Rating		N	N	N	N

Contact Legend
 #22D • #16 ⊕
 #20 ⊖ #12 ◐

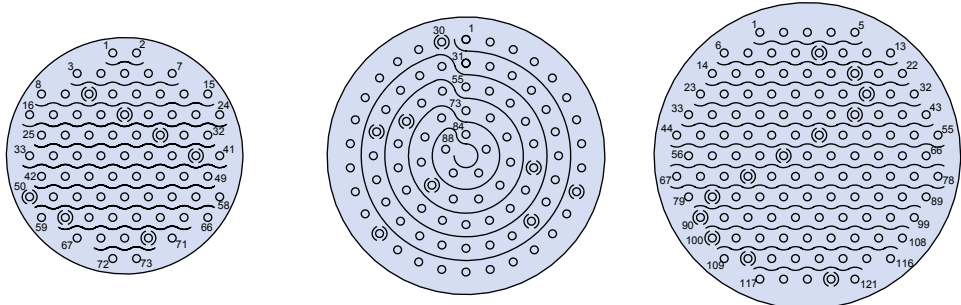

Insert Arrangement	233-105 D38999	17-23	19-23	21-23
No. of Contacts		73	88	121
Contact Size		#23	#23	#23
Service Rating		N	N	N

Contact Legend
 #22D • #16 ⊕
 #20 ⊖ #12 ◐

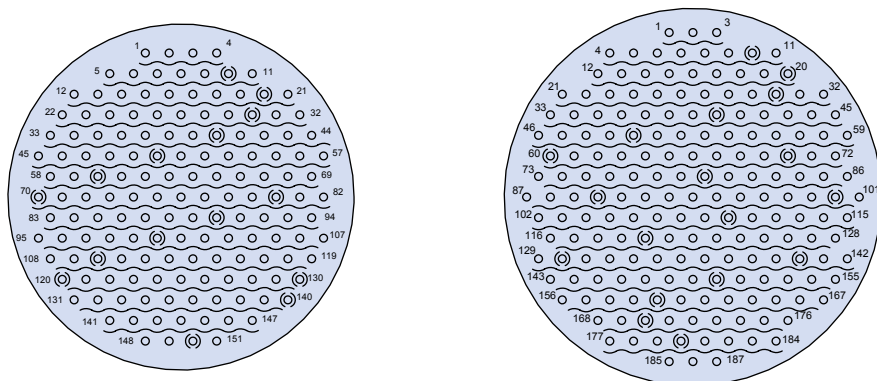

Insert Arrangement	233-105 D38999	23-23	25-23
No. of Contacts		151	187
Contact Size		#23	#23
Service Rating		N	N

*Pending release of MIL-STD-1560C these contact arrangements are only available in Glenair Series 233-105

MIL-DTL-38999 Series III



MIL-STD-1560 combo contact arrangements Reference information

Combo Contact Arrangements							
Contact Size			Number of Contacts			233-105	D38999
			#20	#16	#12		
Size #20 Contacts 7.5 Amp Max. Current #20-#24 AWG 	Size #16 Contacts 13 Amp Max. Current #16-#20 AWG 	Size #12 Contacts 23 Amp Max. Current #12-#14 AWG 	14	1		15-15	D15
			8	4		15-97	D97
			21	2		17-99	E99
			26	2		19-28	F28
			29	1		19-30	F30
			37	2		21-39	G39
			48	8		25-4	J4
				12	12	25-24	J24
			23	20		25-43	J43

Contact Legend
 #22D • #16 ⊕
 #20 ⊖ #12 ●

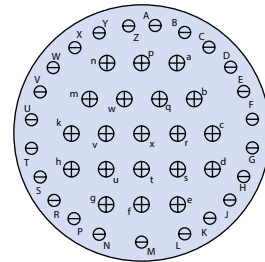
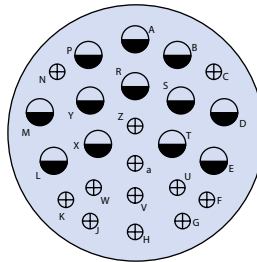

Insert Arrangement	233-105 D38999	25-24 J24	25-43 J43
No. of Contacts and Size		12X #12	12X #16
Service Rating		I	I

Contact Legend
 #22D • #16 ⊕
 #20 ⊖ #12 ●

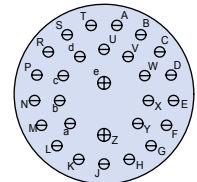
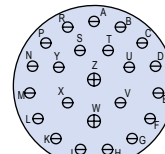
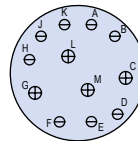
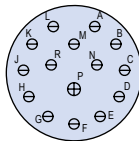

Insert Arrangement	233-105 D38999	15-15 D15	15-97 D97	17-99 E99	19-28 F28
No. of Contacts and Size		1X #16	14X #20	4X #16	8X #20
Service Rating		I	I	I	I

Contact Legend
 #22D • #16 ⊕
 #20 ⊖ #12 ●

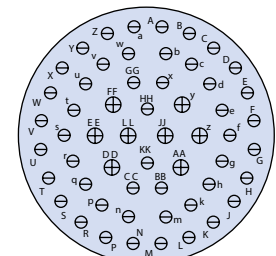
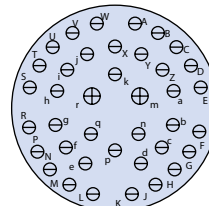
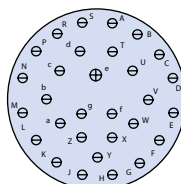

Insert Arrangement	233-105 D38999	19-30 F30	21-39 G39	25-4 J4
No. of Contacts and Size		1X #16	29X #20	2X #16
Service Rating		I	I	I

Recommended cut-out panel Reference information

Recommended Cut-Out Panel

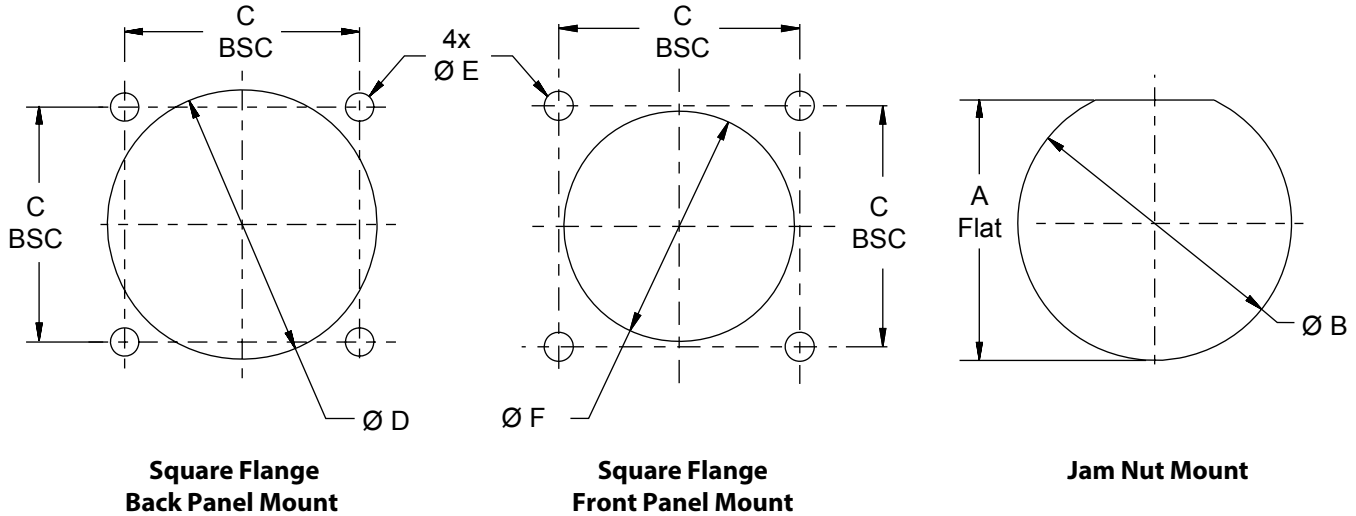

Panel Cut-Out Dimensions							
Shell Size Code	Shell Size	Jam Nut Mount		Square Flange Mount			
		A Flat	B Dia	C BSC	D Dia Min	E Dia Flange Holes	F Dia Min
A	9	.661/.654 (16.79/16.61)	.703/.693 (17.58/17.60)	.719 (18.26)	.656 (16.66)	.133/.123 (3.38/3.12)	.516 (13.12)
B	11	.771/.761 (19.58/19.33)	.835/.825 (21.21/20.96)	.812 (20.62)	.796 (20.22)		.625 (15.88)
C	13	.955/.945 (24.26/24.00)	1.020/1.010 (25.91/25.65)	.906 (23.01)	.922 (23.42)		.750 (19.05)
D	15	1.085/1.075 (27.56/27.31)	1.145/1.135 (29.08/28.83)	.969 (24.61)	1.047 (26.59)		.906 (23.01)
E	17	1.210/1.200 (30.73/30.48)	1.270/1.260 (32.26/32.00)	1.062 (26.97)	1.219 (30.96)		1.016 (25.81)
F	19	1.335/1.325 (33.91/33.66)	1.395/1.385 (35.43/35.18)	1.156 (29.36)	1.297 (32.94)		1.141 (28.98)
G	21	1.460/1.450 (37.08/36.83)	1.520/1.510 (38.61/38.35)	1.250 (31.75)	1.422 (36.12)		1.266 (32.16)
H	23	1.585/1.575 (40.26/40.01)	1.645/1.635 (41.78/41.53)	1.375 (34.93)	1.547 (39.29)	.159/.149 (4.04/3.78)	1.375 (34.93)
J	25	1.710/1.700 (43.43/43.18)	1.770/1.760 (44.96/44.70)	1.500 (38.10)	1.672 (42.47)	.155/.145 (3.94/3.68)	1.484 (37.69)

Alternate key polarization Reference Information

ALTERNATE POLARIZATIONS PER MIL-DTL-38999 SERIES III

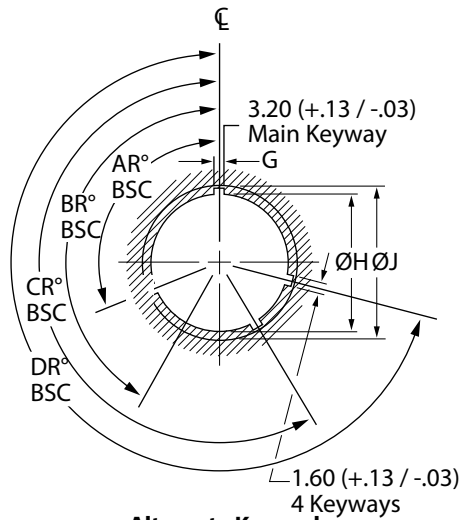

Alternate Key and Keyway Receptacles

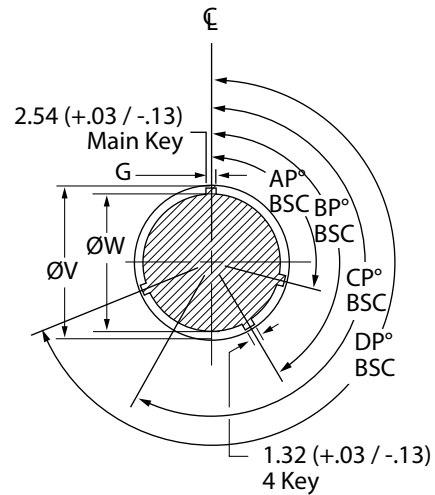

Alternate Key and Keyway Plugs

Series III Alternate Key and Keyway Polarization					
Shell Size	Key and Keyway Code	AR° or AP° BSC	BR° or BP° BSC	CR° or CP° BSC	DR° or DP° BSC
9	N	105	140	215	265
	A	102	132	248	320
	B	80	118	230	312
	C	35	140	205	275
	D	64	155	234	304
	E	91	131	197	240
11 13 15	N	95	141	208	236
	A	113	156	182	292
	B	90	145	195	252
	C	53	156	220	255
	D	119	146	176	298
	E	51	141	184	242
17 19 21 23 25	N	80	142	196	293
	A	135	170	200	310
	B	49	169	200	244
	C	66	140	200	257
	D	62	145	180	280
	E	79	153	197	272

Glenair's Universal Key is intermateable with all MIL-DTL-38999 Series III polarizations.

233-105 Crimp contact series with accessory threads

How To Order - 233-105							
Sample Part Number	233-105	-20	NF	17-8	P	N	-LC
Series / Basic Part No.	MIL-DTL-38999 Series III Environmental Connector						
Connector Style	20 = Wall mount receptacle 24 = Jam nut receptacle 26 = Plug						
Material and Finish	See Table I						
Shell Size-Insert Arrangement	Per MIL-STD-1560						
Contact Type	P = Pin, 500 cycles A = Pin insert, less standard contacts			S = Socket, 500 cycles B = Socket insert, less standard contacts			
Alternate Polarization	A, B, C, D, E, N = Normal						
Mod Code for Less Contacts	Connector marked with P or S according to insert but supplied less contacts						

Table I: Material and Finish				
38999	233-105	Material	Finish Description	RoHS
F	ME	Aluminum	Electroless nickel (48 hr. salt spray)	<input checked="" type="checkbox"/>
G	MA		Space-grade electroless nickel, matte (48 hr. salt spray)	<input checked="" type="checkbox"/>
T	MT		Ni-PTFE	<input checked="" type="checkbox"/>
W	NF		Cadmium O.D. over electroless nickel (500 hr. salt spray)	<input type="checkbox"/>
Z*	ZR		Black zinc-nickel over electroless nickel	<input checked="" type="checkbox"/>
*qualification pending				

Connector Mating and Accessory Thread Dimensions			
Shell Size Code	Shell Size	A Thread	J Thread
A	9	.6250-.1P-.3L-TS-2A	M12 X 1.0-6g 0.100R
B	11	.7500-.1P-.3L-TS-2A	M15 X 1.0-6g 0.100R
C	13	.8750-.1P-.3L-TS-2A	M18 X 1.0-6g 0.100R
D	15	1.0000-.1P-.3L-TS-2A	M22 X 1.0-6g 0.100R
E	17	1.1875-.1P-.3L-TS-2A	M25 X 1.0-6g 0.100R
F	19	1.2500-.1P-.3L-TS-2A	M28 X 1.0-6g 0.100R
G	21	1.3750-.1P-.3L-TS-2A	M31 X 1.0-6g 0.100R
H	23	1.5000-.1P-.3L-TS-2A	M34 X 1.0-6g 0.100R
J	25	1.6250-.1P-.3L-TS-2A	M37 X 1.0-6g 0.100R

Wire Accommodation	
Contact Size	Wire Gauge
23	#22 - #28
22D	#22 - #28
20	#20 - #24
16	#16 - #20
12	#12 - #14

NOTES

- 233-105 is designed to meet or exceed the mechanical, electrical, environmental and dimensional requirements of D38999/20, /24 & /26.
- Insert arrangements IAW MIL-STD-1560, Glenair HD and size #8 shielded contact insert arrangements available only in COTS series
- Blue color band indicates rear release retention system.
- Connector is supplied with contacts (including spares), insertion/removal tool and sealing plugs.
- Dimensions in inches (millimeters) are subject to change without notice
- Consult factory for additional information

MIL-DTL-38999 Series III Environmental connectors

D38999/20, /24, /26 Crimp contact series



How To Order - Mil-Spec							
Sample Part Number	D38999/	20	W	A	35	P	N
Series / Basic Part No.	MIL-DTL-38999 Series III Environmental Connector						
Connector Style	20 = Wall mount receptacle 24 = Jam nut receptacle 26 = Plug						
Class (Material and Finish)	See Table I						
Shell Size Code	A, B, C, D, E, F, G, H and J (per MIL-STD-1560)						
Insert Pattern	See pages 4–9 (per MIL-STD-1560)						
Contact Type	P = Pin, 500 cycles A = Pin insert, less standard contacts			S = Socket, 500 cycles B = Socket insert, less standard contacts			
Alternate Polarization	A, B, C, D, E, N = Normal						

PLUG WITH ACCESSORY THREADS

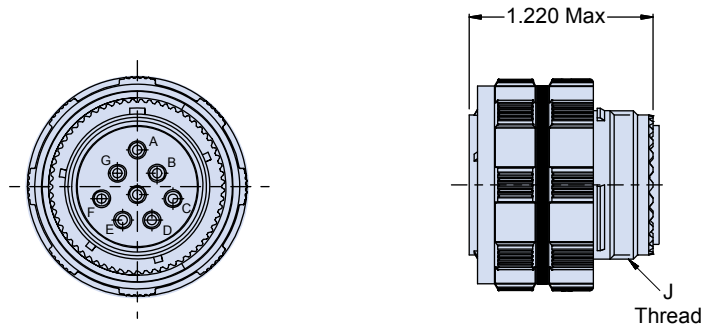

JAM NUT RECEPTACLE AND WALL MOUNT RECEPTACLE

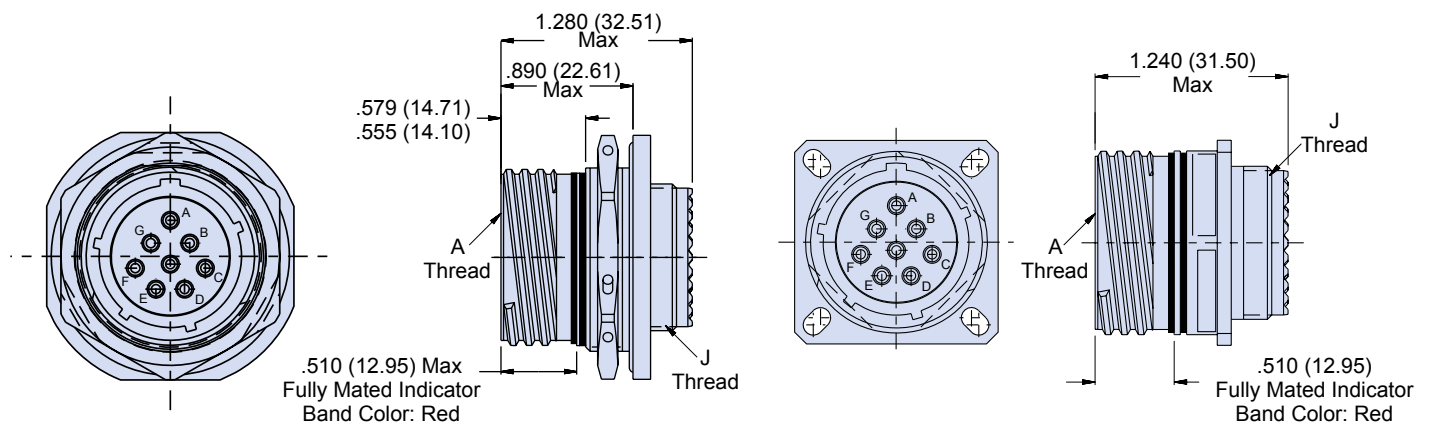



The new
MIL-DTL-38999
go-to supplier



MIL-DTL-38999

One-stop shopping and outstanding availability

Industry standard and special design
MIL-DTL-38999 mil-aero cylindrical connectors
from the most accommodating engineering and
manufacturing team in the interconnect industry—
we say yes to standards and specials!

ENGINEERED SOLUTIONS AND EXOTIC DERIVATIVES

- High-density, push-pull, lanyard release, high temperature, ground plane, compliant pin, zero extraction force, thru-bulkhead, space-grade, gender changers, modified flange, or any other modification needed to solve a complex interconnect challenge
- Liberal policies on NRE costs, minimum order quantities and delivery schedules

QPL MIL-DTL-38999 CONNECTORS



D38999/26 Plug

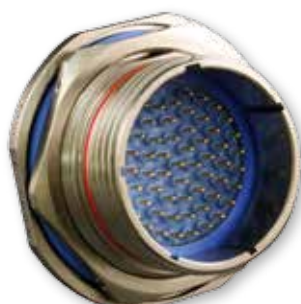

D38999/24 Jam nut receptacle



D38999/20 Wall mount receptacle

GLENNAIR SUPERNINE® ADVANCED PERFORMANCE CONNECTORS



SuperNine®
 environmental I/O, cable
 and PCB connectors



SuperNine®
 high-pressure hermetic
 connectors



SuperNine® ruggedized
 RJ45 and USB connectors



SuperNine® EMI/EMP
 filter connectors



SuperNine®
 fiber optic connectors

BULKHEAD FEED-THRU AND SAV-CON® CONNECTOR SAVERS



Bulkhead feed-thrus
 Special extended-length bulkhead penetrators



Sav-Con® Connector Savers
 and gender changers



INNOVATIVE SHELL PACKAGE MODIFICATIONS AND MATING TECHNOLOGIES



Mounting flange
 modifications



Quick-disconnect push-pull
 and lanyard-release mating



Integrated/housed
 electronics



Integrated band/
 boot porch



Blind-mate and
 low-extraction force

NON-STANDARD CONTACT LAYOUTS



Hybrid power
 contact arrangement



Sealed Coax
 insert arrangement



Hybrid shielded contact/signal
 contact insert arrangement



Optronic (transmitter/receiver)
 contact arrangement



Out of This World
**INTERCONNECT
SOLUTIONS**

Glenair, Inc.

1211 Air Way • Glendale, California • 91201-2497
Telephone: 818-247-6000 • Fax: 818-500-9912 • sales@glenair.com
www.glenair.com

**Glenair Power
Products Group** Telephone: 203-741-1115
860 N. Main Street Extension Facsimile:
Wallingford, CT 203-741-0053
06492 sales@glenair.com

Glenair UK Ltd Telephone: +44-1623-638100
40 Lower Oakham Way Facsimile:
Oakham Business Park +44-1623-638111
P.O. Box 37, Mansfield sales@glenair.co.uk
Notts, NG18 5BY England

Glenair Microway Systems Telephone: 847-679-8833
7000 North Lawndale Avenue Facsimile:
Lincolnwood, IL 847-679-8849
60712

Glenair Nordic AB Telephone: +46-8-50550000
Gustav III : S Boulevard 46 sales@glenair.se
SE-169 27 Solna
Sweden

Glenair Electric GmbH Telephone: 06172 / 68 16 0
Schaberweg 28 Facsimile:
61348 Bad Homburg 06172 / 68 16 90
Germany info@glenair.de

Glenair Iberica Telephone: +34-925-89-29-88
C/ La Vega, 16 Facsimile:
45612 Velada +34-925-89-29-87
Spain sales@glenair.es

Glenair Italia S.p.A. Telephone: +39-051-782811
Via Del Lavoro, 7 Facsimile:
40057 Quarto Inferiore – +39-051-782259
Granarolo dell'Emilia info@glenair.it
Bologna, Italy

Glenair France SARL Telephone: +33-5-34-40-97-40
7, Avenue Parmentier Facsimile:
Immeuble Central Parc #2 +33-5-61-47-86-10
31200 Toulouse sales@glenair.fr
France

Glenair Korea Telephone: +82-31-8068-1090
B-1304 Gunpo IT Valley Facsimile:
148 Gosan-Ro, Gunpo-Si +82-31-8068-1092
Kyunggi-Do, Korea sales@glenair.kr
435-733

