



TO-220-3L/TO-220F Plastic-Encapsulate Diodes

SBD20150TCTB、SBDF20150TCTB SCHOTTKY BARRIER RECTIFIER

MAIN CHARACTERISTICS

| | |
|--------------|-------------------------------|
| I_o | 20 (2×10) A |
| V_{RRM} | 150 V |
| T_j | 150 °C |
| $V_{F(typ)}$ | 0.68V (@ $T_j=125^{\circ}C$) |

FEATURES

- Low Power Loss, High Efficiency
- Guard Ring Die Construction for Transient Protection
- High Current Capability and Low Forward Voltage Drop

MARKING

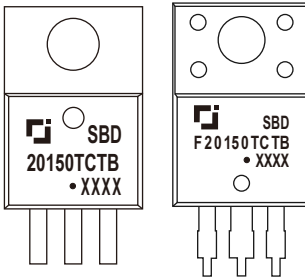

SBD(F)20150CT = Device code
 Solid dot = Green molding compound device
 if none, the normal device
 XXXX = Code

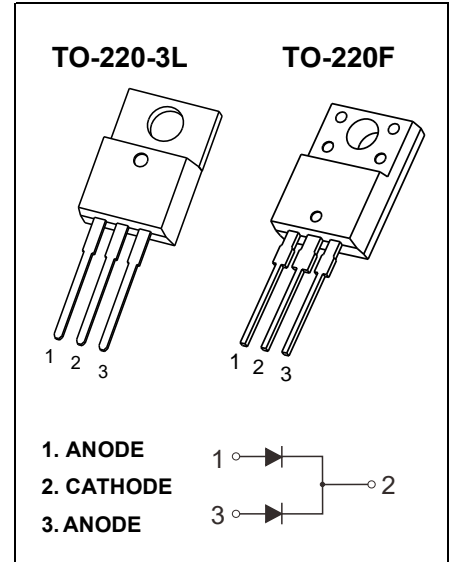

MAXIMUM RATINGS ($T_a=25^{\circ}C$ unless otherwise noted)

| Symbol | Parameter | SBD | | Unit |
|-----------------|------------------------------------------------------------------|----------|----------|---------------|
| | | 20150CT | F20150CT | |
| V_{RRM} | Peak repetitive reverse voltage | 150 | | V |
| V_{RWM} | Working peak reverse voltage | | | |
| V_R | DC blocking voltage | | | |
| $V_{R(RMS)}$ | RMS reverse voltage | 105 | | V |
| I_o | Average rectified output current | ∅ | | A |
| I_{FSM} | Non-Repetitive peak forward surge current (8.3ms half sine wave) | 150 | | A |
| $R_{\theta Jc}$ | Thermal resistance from junction to case , $T_c=25^{\circ}C$ | 2.0 | 3.0 | $^{\circ}C/W$ |
| $R_{\theta JA}$ | Thermal resistance from junction to ambient | 62.5 | | $^{\circ}C/W$ |
| T_j | Junction temperature | 150 | | $^{\circ}C$ |
| T_{stg} | Storage temperature | -55~+150 | | $^{\circ}C$ |

ELECTRICAL CHARACTERISTICS ($T_a=25^{\circ}C$ unless otherwise specified)

| Parameter | Symbol | Test conditions | Min | Typ | Max | Unit |
|-----------------|------------|-----------------|--------------------|------|-----|---------|
| Reverse voltage | $V_{(BR)}$ | $I_R=100\mu A$ | 150 | | | V |
| Reverse current | I_R | $V_R=150V$ | $T_j=25^{\circ}C$ | 1.0 | 100 | μA |
| | | | $T_j=125^{\circ}C$ | 5.0 | | mA |
| Forward voltage | V_F | $I_F=5A$ | $T_j=25^{\circ}C$ | 0.75 | | V |
| | | | $T_j=125^{\circ}C$ | 0.58 | | V |
| | | $I_F=10A$ | $T_j=25^{\circ}C$ | 1.06 | 1.1 | V |
| | | | $T_j=125^{\circ}C$ | 0.68 | | V |

*Pulse test: pulse width $\leq 300\mu s$, duty cycles $\leq 2.0\%$.

Typical Characteristics

FIG.1: FORWARD CURRENT DERATING CURVE

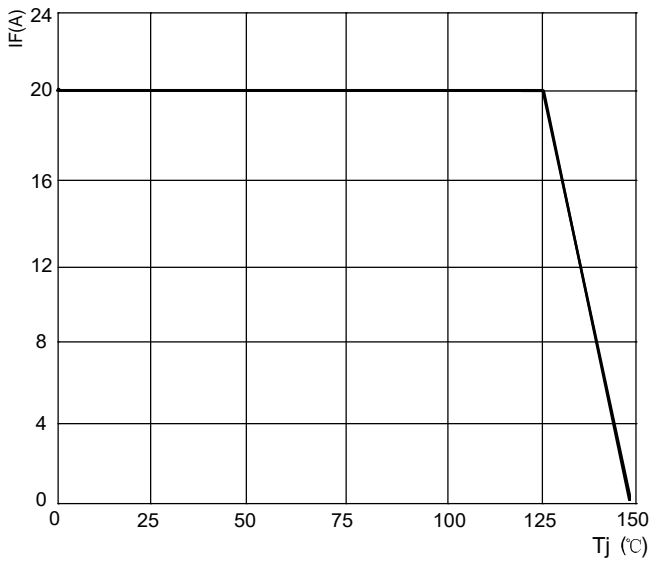

FIG.2: TYPICAL FORWARD CHARACTERISTICS

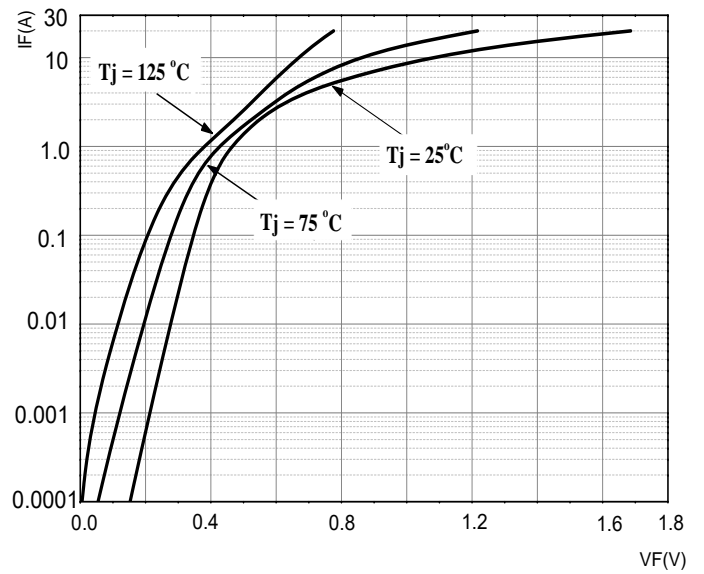

FIG.3: TOTAL CAPACITANCE DERATING CURVE

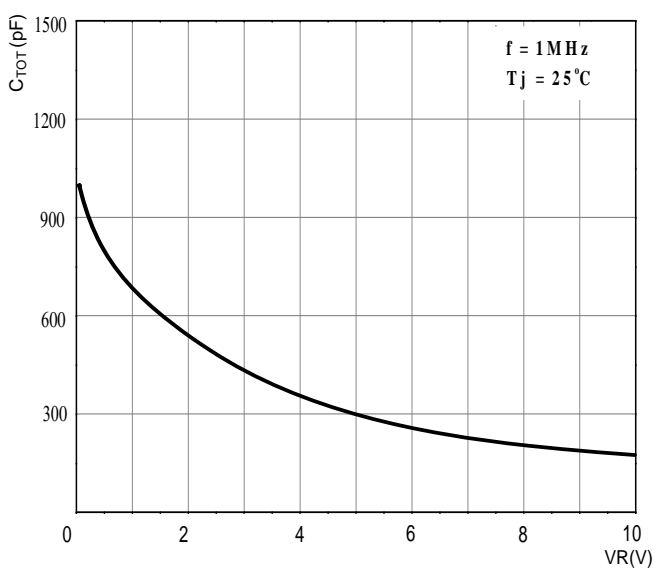
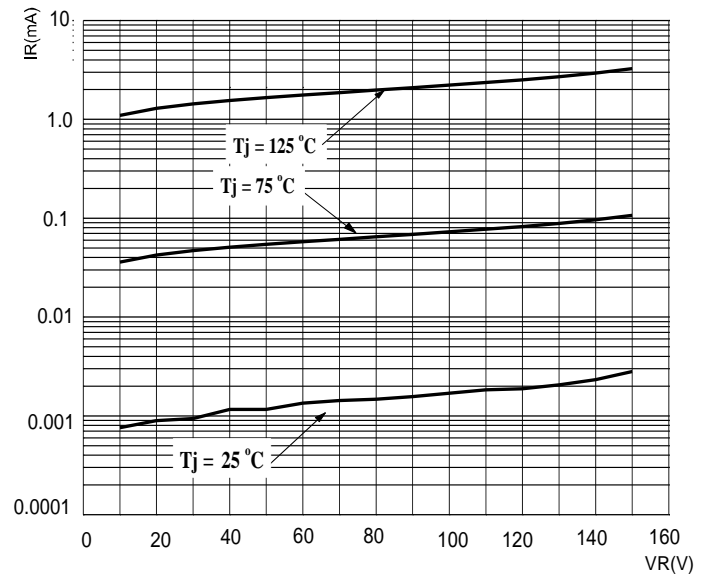

FIG.4: TYPICAL REVERSE CHARACTERISTICS



TO-220-3L Package Outline Dimensions



| Symbol | Dimensions In Millimeters | | Dimensions In Inches | |
|--------|---------------------------|--------|----------------------|-------|
| | Min | Max | Min | Max |
| A | 4.450 | 4.750 | 0.175 | 0.187 |
| A1 | 2.520 | 2.820 | 0.099 | 0.111 |
| b | 0.710 | 0.910 | 0.028 | 0.036 |
| b1 | 1.170 | 1.370 | 0.046 | 0.054 |
| c | 0.300 | 0.500 | 0.012 | 0.020 |
| c1 | 1.170 | 1.370 | 0.046 | 0.054 |
| D | 9.830 | 10.330 | 0.387 | 0.407 |
| E | 8.500 | 8.900 | 0.335 | 0.350 |
| E1 | 12.050 | 12.650 | 0.474 | 0.498 |
| e | 2.540 TYP | | 0.100 TYP | |
| e1 | 4.900 | 5.200 | 0.192 | 0.205 |
| F | 2.540 | 2.940 | 0.100 | 0.116 |
| h | 0.100 TYP | | 0.004 TYP | |
| L | 13.300 | 13.800 | 0.523 | 0.543 |
| L1 | 3.540 | 3.940 | 0.139 | 0.155 |
| Φ | 3.735 | 3.935 | 0.147 | 0.155 |

TO-220F Package Outline Dimensions

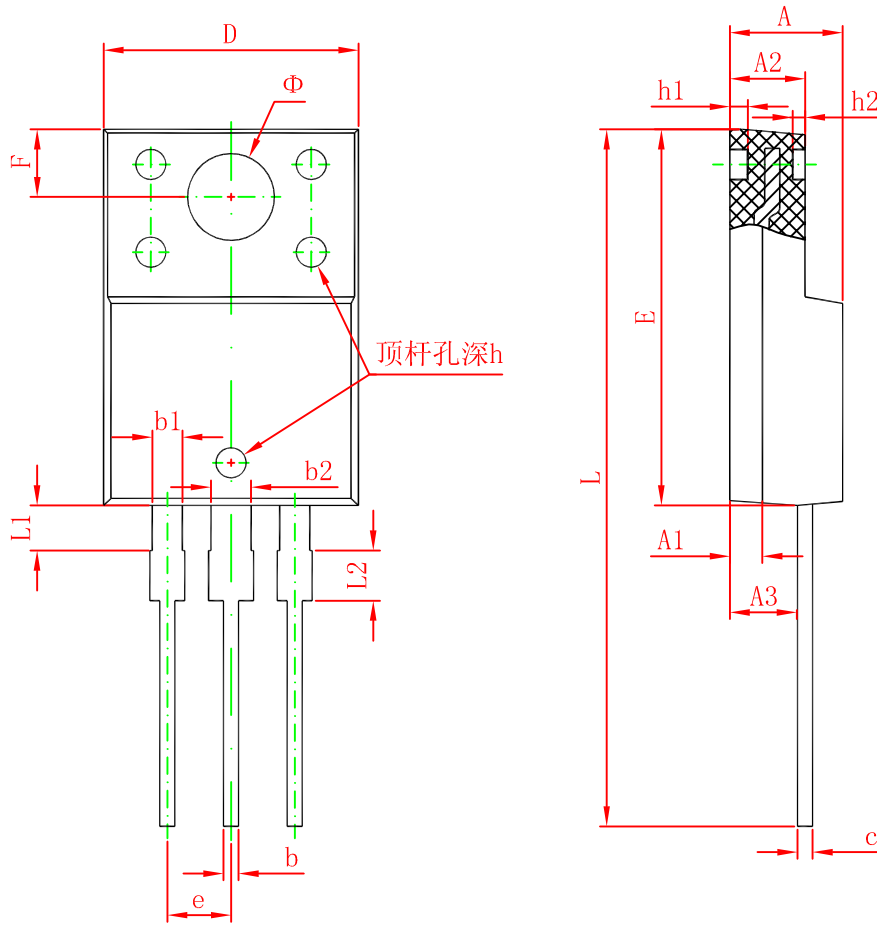

| Symbol | Dimensions In Millimeters | | Dimensions In Inches | |
|--------|---------------------------|--------|----------------------|-------|
| | Min. | Max. | Min. | Max. |
| A | 4.300 | 4.700 | 0.169 | 0.185 |
| A1 | 1.300 REF. | | 0.051 REF. | |
| A2 | 2.800 | 3.200 | 0.110 | 0.126 |
| A3 | 2.500 | 2.900 | 0.098 | 0.114 |
| b | 0.500 | 0.750 | 0.020 | 0.030 |
| b1 | 1.100 | 1.350 | 0.043 | 0.053 |
| b2 | 1.500 | 1.750 | 0.059 | 0.069 |
| c | 0.500 | 0.750 | 0.020 | 0.030 |
| D | 9.960 | 10.360 | 0.392 | 0.408 |
| E | 14.800 | 15.200 | 0.583 | 0.598 |
| e | 2.540 TYP. | | 0.100 TYP. | |
| F | 2.700 REF. | | 0.106 REF. | |
| ϕ | 3.500 REF. | | 0.138 REF. | |
| h | 0.000 | 0.300 | 0.000 | 0.012 |
| h1 | 0.800 REF. | | 0.031 REF. | |
| h2 | 0.500 REF. | | 0.020 REF. | |
| L | 28.000 | 28.400 | 1.102 | 1.118 |
| L1 | 1.700 | 1.900 | 0.067 | 0.075 |
| L2 | 1.900 | 2.100 | 0.075 | 0.083 |