

UKK 3-MSTB-5,08 AU 32L - Double-level terminal block



2770969

<https://www.phoenixcontact.com/us/products/2770969>

Please be informed that the data shown in this PDF document is generated from our online catalog. Please find the complete data in the user documentation. Our general terms of use for downloads are valid.



Double-level terminal block, 32-pos. blocked, nom. voltage: 250 V, nominal current: 10 A, number of connections: 128, number of positions: 32, connection method: Screw/plug-in connection, 1st and 2nd level connection left, cross section: 0.2 mm² - 4 mm², mounting type: NS 35/7,5, NS 35/15, NS 32, color: gray

Commercial data

Item number	2770969
Packing unit	5 pc
Minimum order quantity	5 pc
Sales key	BE12
Product key	BE1241
GTIN	4017918243357
Weight per piece (including packing)	145.82 g
Weight per piece (excluding packing)	116.4 g
Customs tariff number	85369010
Country of origin	PL

UKK 3-MSTB-5,08 AU 32L - Double-level terminal block



2770969

<https://www.phoenixcontact.com/us/products/2770969>

Technical data

Notes

General	Current and voltage are determined by the plug used.
---------	--

Product properties

Product type	Hybrid terminal block
Product family	UKK 3-MSTB
Number of positions	32
Pitch	5.08 mm
Number of connections	128
Number of rows	2
Potentials	64

Insulation characteristics

Overvoltage category	III
Degree of pollution	3

Electrical properties

Rated surge voltage	4 kV
Maximum power dissipation for nominal condition	0 W

Connection data

1st and 2nd level connection left

Screw thread	M3
Tightening torque	0.5 ... 0.6 Nm
Stripping length	8 mm
Internal cylindrical gage	A3
Conductor cross section rigid	0.2 mm ² ... 4 mm ²
Cross section AWG	24 ... 12 (converted acc. to IEC)
Conductor cross section flexible	0.2 mm ² ... 2.5 mm ²
Conductor cross section, flexible [AWG]	24 ... 14 (converted acc. to IEC)
Conductor cross-section flexible (ferrule without plastic sleeve)	0.25 mm ² ... 2.5 mm ²
Flexible conductor cross section (ferrule with plastic sleeve)	0.25 mm ² ... 1.5 mm ²
2 conductors with same cross section, solid	0.2 mm ² ... 1.5 mm ²
2 conductors with same cross section, flexible	0.2 mm ² ... 1 mm ²
2 conductors with same cross section, flexible, with ferrule without plastic sleeve	0.25 mm ² ... 0.5 mm ²
2 conductors with the same cross section, flexible, with TWIN ferrule with plastic sleeve	0.5 mm ² ... 1 mm ²
Nominal current	10 A
Maximum load current	12 A (with 4 mm ² conductor cross section)
Nominal voltage	250 V

UKK 3-MSTB-5,08 AU 32L - Double-level terminal block



2770969

<https://www.phoenixcontact.com/us/products/2770969>

Dimensions

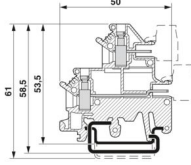
Dimensional drawing	
Width	88.9 mm
End cover width	2.5 mm
Height	50 mm
Depth on NS 35/7,5	53.5 mm
Pitch	5.08 mm

Material specifications

Color	gray
Flammability rating according to UL 94	V2
Insulating material group	I
Insulating material	PA
Contact surface	Gold Au

Mechanical properties

Mechanical data

Open side panel	Yes
-----------------	-----

Environmental and real-life conditions

Ambient conditions

Ambient temperature (operation)	-60 °C (max. operating temperature see derating curve)
Ambient temperature (storage/transport)	-25 °C ... 60 °C (for a short time, no longer than 24 h, -60°C to +70°C)
Ambient temperature (assembly)	-5 °C ... 70 °C
Ambient temperature (actuation)	-5 °C ... 70 °C
Permissible humidity (operation)	20 % ... 90 %
Permissible humidity (storage/transport)	30 % ... 70 %

Mounting

Mounting type	NS 35/7,5
	NS 35/15
	NS 32

UKK 3-MSTB-5,08 AU 32L - Double-level terminal block

2770969

<https://www.phoenixcontact.com/us/products/2770969>

Drawings

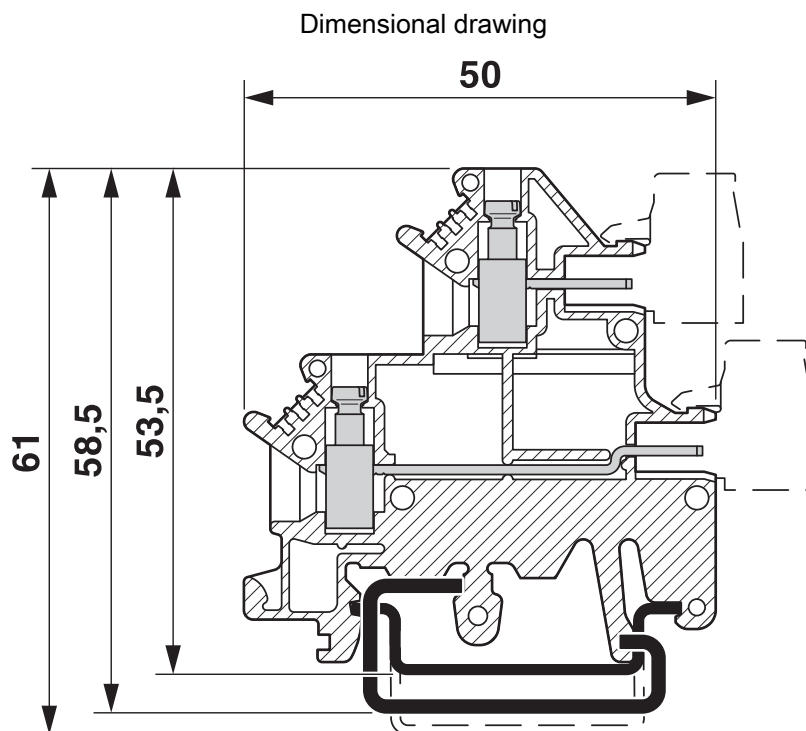

UKK 3-MSTB-5,08 AU 32L - Double-level terminal block



2770969

<https://www.phoenixcontact.com/us/products/2770969>

Approvals

🔗 To download certificates, visit the product detail page: <https://www.phoenixcontact.com/us/products/2770969>



EAC

Approval ID: RU C-DE.BL08.B.00534

UKK 3-MSTB-5,08 AU 32L - Double-level terminal block



2770969

<https://www.phoenixcontact.com/us/products/2770969>

Classifications

ECLASS

ECLASS-11.0	27141120
ECLASS-13.0	27250201

ETIM

ETIM 9.0	EC000897
----------	----------

UNSPSC

UNSPSC 21.0	39121400
-------------	----------

UKK 3-MSTB-5,08 AU 32L - Double-level terminal block



2770969

<https://www.phoenixcontact.com/us/products/2770969>

Environmental product compliance

EU RoHS

Fulfills EU RoHS substance requirements	Yes
Exemption	6(c)

China RoHS

Environment friendly use period (EFUP)	EFUP-50
	An article-related China RoHS declaration table can be found in the download area for the respective article under "Manufacturer declaration". For all articles with EFUP-E, no China RoHS declaration table issued and required.

EU REACH SVHC

REACH candidate substance (CAS No.)	Lead(CAS: 7439-92-1)
-------------------------------------	----------------------

UKK 3-MSTB-5,08 AU 32L - Double-level terminal block

2770969

<https://www.phoenixcontact.com/us/products/2770969>

Accessories

 Note: Applying some accessories below might limit this product.

EBL 2- 5 - Insertion bridge

2303145

<https://www.phoenixcontact.com/us/products/2303145>

Insertion bridge, pitch: 5.2 mm, number of positions: 2, color: gray



 Max. current carrying capacity: 12 A

EBL 3- 5 - Insertion bridge

2303158

<https://www.phoenixcontact.com/us/products/2303158>

Insertion bridge, pitch: 5.2 mm, number of positions: 3, color: gray



 Max. current carrying capacity: 12 A

UKK 3-MSTB-5,08 AU 32L - Double-level terminal block



2770969

<https://www.phoenixcontact.com/us/products/2770969>

DP-UKK 3-MSTB-5,08 - Spacer plate

2770600

<https://www.phoenixcontact.com/us/products/2770600>

Spacer plate, to compensate for level offsets, pitch: 5.08 mm, width: 2.5 mm, height: 50 mm, number of positions: 1, color: gray



DG-UKK 3-MSTB-5,08 - End cover

2770613

<https://www.phoenixcontact.com/us/products/2770613>

End cover, pitch: 5.08 mm, width: 2.2 mm, number of positions: 1, color: gray



UKK 3-MSTB-5,08 AU 32L - Double-level terminal block

2770969

<https://www.phoenixcontact.com/us/products/2770969>

D-UKK 3-MSTB-5,08 L - End cover

2770914

<https://www.phoenixcontact.com/us/products/2770914>



End cover, pitch: 5.08 mm, depth: 42.3 mm, width: 2.5 mm, height: 50 mm, number of positions: 1, color: gray

D-UKK 3-MSTB-5,08 - End cover

2770891

<https://www.phoenixcontact.com/us/products/2770891>

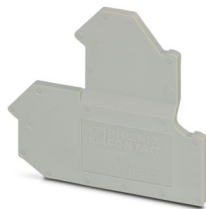

End cover, pitch: 5.08 mm, depth: 53.5 mm, width: 2.5 mm, height: 50 mm, number of positions: 1, color: gray

UKK 3-MSTB-5,08 AU 32L - Double-level terminal block



2770969

<https://www.phoenixcontact.com/us/products/2770969>

SBS 5:UNBEDRUCKT - Marker card

1007219

<https://www.phoenixcontact.com/us/products/1007219>



Marker card, Card, white, unlabeled, can be labeled with: Marker pen, perforated, mounting type: snap into tall marker groove, snap into flat marker groove, for terminal block width: 5 mm, lettering field size: 6 x 5.1 mm, Number of individual labels: 250

SZS 0,6X3,5 - Screwdriver

1205053

<https://www.phoenixcontact.com/us/products/1205053>



Actuation tool, for ST terminal blocks, insulated, also suitable for use as a bladed screwdriver, size: 0.6 x 3.5 x 100 mm, 2-component grip, with non-slip grip

UKK 3-MSTB-5,08 AU 32L - Double-level terminal block



2770969

<https://www.phoenixcontact.com/us/products/2770969>

NS 32 PERF 2000MM-VPE 10 - DIN rail perforated

1201002

<https://www.phoenixcontact.com/us/products/1201002>



DIN rail perforated, Pack of 10 (20 m), acc. to EN 60715, material: Steel, galvanized, passivated with a thick layer, G profile, color: silver

NS 32 UNPERF 2000MM-VPE 10 - DIN rail, unperforated

1201015

<https://www.phoenixcontact.com/us/products/1201015>



DIN rail, unperforated, Pack of 10 (20 m), acc. to EN 60715, material: Steel, galvanized, passivated with a thick layer, G profile, color: silver

UKK 3-MSTB-5,08 AU 32L - Double-level terminal block



2770969

<https://www.phoenixcontact.com/us/products/2770969>

NS 35/ 7,5 PERF 2000MM - DIN rail perforated

0801733

<https://www.phoenixcontact.com/us/products/0801733>



DIN rail perforated, Pack of 25 (50 m), acc. to EN 60715, material: Steel, galvanized, passivated with a thick layer, Standard profile, color: silver

NS 35/ 7,5 UNPERF 2000MM - DIN rail, unperforated

0801681

<https://www.phoenixcontact.com/us/products/0801681>



DIN rail, unperforated, Pack of 25 (50 m), acc. to EN 60715, material: Steel, galvanized, passivated with a thick layer, Standard profile, color: silver

UKK 3-MSTB-5,08 AU 32L - Double-level terminal block



2770969

<https://www.phoenixcontact.com/us/products/2770969>

NS 35/ 7,5 WH PERF 2000MM - DIN rail perforated

1204119

<https://www.phoenixcontact.com/us/products/1204119>



DIN rail perforated, Pack of 25 (50 m), acc. to EN 60715, material: Steel, Galvanized, white passivated, Standard profile, color: silver

NS 35/ 7,5 WH UNPERF 2000MM-VPE 10 - DIN rail, unperforated

1204122

<https://www.phoenixcontact.com/us/products/1204122>



DIN rail, unperforated, Pack of 10 (20 m), acc. to EN 60715, material: Steel, Galvanized, white passivated, Standard profile, color: silver

UKK 3-MSTB-5,08 AU 32L - Double-level terminal block



2770969

<https://www.phoenixcontact.com/us/products/2770969>

NS 35/ 7,5 AL UNPERF 2000MM - DIN rail, unperforated

0801704

<https://www.phoenixcontact.com/us/products/0801704>



DIN rail, unperforated, Pack of 25 (50 m), acc. to EN 60715, material: Aluminum, uncoated, Standard profile, color: silver

NS 35/ 7,5 ZN PERF 2000MM - DIN rail perforated

1206421

<https://www.phoenixcontact.com/us/products/1206421>



DIN rail perforated, Pack of 25 (50 m), acc. to EN 60715, material: Steel, galvanized, Standard profile, color: silver

UKK 3-MSTB-5,08 AU 32L - Double-level terminal block



2770969

<https://www.phoenixcontact.com/us/products/2770969>

NS 35/ 7,5 ZN UNPERF 2000MM - DIN rail, unperforated

1206434

<https://www.phoenixcontact.com/us/products/1206434>



DIN rail, unperforated, Pack of 25 (50 m), acc. to EN 60715, material: Steel, galvanized, Standard profile, color: silver

NS 35/ 7,5 CU UNPERF 2000MM-VPE 10 - DIN rail, unperforated

0801762

<https://www.phoenixcontact.com/us/products/0801762>



DIN rail, unperforated, Pack of 10 (20 m), acc. to EN 60715, material: Copper, uncoated, Standard profile, color: copper-colored

UKK 3-MSTB-5,08 AU 32L - Double-level terminal block



2770969

<https://www.phoenixcontact.com/us/products/2770969>

NS 35/ 7,5 CAP - End cap

1206560

<https://www.phoenixcontact.com/us/products/1206560>

DIN rail end piece, for DIN rail NS 35/7.5



NS 35/15 PERF 2000MM - DIN rail perforated

1201730

<https://www.phoenixcontact.com/us/products/1201730>



DIN rail perforated, Pack of 25 (50 m), similar to EN 60715, material: Steel, galvanized, passivated with a thick layer, Standard profile, color: silver

UKK 3-MSTB-5,08 AU 32L - Double-level terminal block



2770969

<https://www.phoenixcontact.com/us/products/2770969>

NS 35/15 UNPERF 2000MM - DIN rail, unperforated

1201714

<https://www.phoenixcontact.com/us/products/1201714>



DIN rail, unperforated, Pack of 25 (50 m), similar to EN 60715, material: Steel, galvanized, passivated with a thick layer, Standard profile, color: silver

NS 35/15 WH PERF 2000MM - DIN rail perforated

0806602

<https://www.phoenixcontact.com/us/products/0806602>



DIN rail perforated, Pack of 25 (50 m), similar to EN 60715, material: Steel, Galvanized, white passivated, Standard profile, color: white

UKK 3-MSTB-5,08 AU 32L - Double-level terminal block



2770969

<https://www.phoenixcontact.com/us/products/2770969>

NS 35/15 WH UNPERF 2000MM-VPE 10 - DIN rail, unperforated

1204135

<https://www.phoenixcontact.com/us/products/1204135>



DIN rail, unperforated, Pack of 10 (20 m), similar to EN 60715, material: Steel, Galvanized, white passivated, Standard profile, color: silver

NS 35/15 AL UNPERF 2000MM - DIN rail, unperforated

1201756

<https://www.phoenixcontact.com/us/products/1201756>



DIN rail, unperforated, similar to EN 60715, material: Aluminum, uncoated, Standard profile, color: silver

UKK 3-MSTB-5,08 AU 32L - Double-level terminal block

2770969

<https://www.phoenixcontact.com/us/products/2770969>

NS 35/15 ZN PERF 2000MM - DIN rail perforated

1206599

<https://www.phoenixcontact.com/us/products/1206599>



DIN rail perforated, Pack of 25 (50 m), similar to EN 60715, material: Steel, galvanized, Standard profile, color: silver

NS 35/15 ZN UNPERF 2000MM - DIN rail, unperforated

1206586

<https://www.phoenixcontact.com/us/products/1206586>



DIN rail, unperforated, Pack of 25 (50 m), similar to EN 60715, material: Steel, galvanized, Standard profile, color: silver

UKK 3-MSTB-5,08 AU 32L - Double-level terminal block



2770969

<https://www.phoenixcontact.com/us/products/2770969>

NS 35/15 CU UNPERF 2000MM-VPE 10 - DIN rail, unperforated

1201895

<https://www.phoenixcontact.com/us/products/1201895>



DIN rail, unperforated, Pack of 10 (20 m), similar to EN 60715, material: Copper, uncoated, Standard profile, color: copper-colored

NS 35/15 CAP - End cap

1206573

<https://www.phoenixcontact.com/us/products/1206573>

DIN rail end piece, for DIN rail NS 35/15



UKK 3-MSTB-5,08 AU 32L - Double-level terminal block



2770969

<https://www.phoenixcontact.com/us/products/2770969>

NS 35/15-2,3 UNPERF 2000MM-VPE 10 - DIN rail, unperforated

1201798

<https://www.phoenixcontact.com/us/products/1201798>



DIN rail, unperforated, Pack of 10 (20 m), acc. to EN 60715, material: Steel, galvanized, passivated with a thick layer, Standard profile 2.3 mm, color: silver

ZB 5,08:UNBEDRUCKT - Zack marker strip

0809793

<https://www.phoenixcontact.com/us/products/0809793>



Zack marker strip, Strip, white, unlabeled, can be labeled with: PLOTMARK, CMS-P1-PLOTTER, mounting type: snapped, for terminal block width: 5.08 mm, lettering field size: 4.98 x 10.5 mm, Number of individual labels: 10

UKK 3-MSTB-5,08 AU 32L - Double-level terminal block

2770969

<https://www.phoenixcontact.com/us/products/2770969>

ZB 5,08 CUS - Zack marker strip

0824963

<https://www.phoenixcontact.com/us/products/0824963>

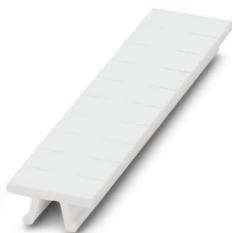

Zack marker strip, can be ordered: Strip, white, labeled according to customer specifications, mounting type: snap into tall marker groove, for terminal block width: 5.08 mm, lettering field size: 4.98 x 10.5 mm, Number of individual labels: 10

ZB 5,08,LGS:FORTL.ZAHLEN - Zack marker strip

0809803

<https://www.phoenixcontact.com/us/products/0809803>



Zack marker strip, Strip, white, labeled, printed horizontally: consecutive numbers 1 ... 10, 11 ... 20, etc. up to 91 ... 100, mounting type: snapped, for terminal block width: 5.08 mm, lettering field size: 4.98 x 10.5 mm, Number of individual labels: 10

UKK 3-MSTB-5,08 AU 32L - Double-level terminal block



2770969

<https://www.phoenixcontact.com/us/products/2770969>

ZB 5,08,QR:FORTL.ZAHLEN - Zack marker strip

0809858

<https://www.phoenixcontact.com/us/products/0809858>



Zack marker strip, Strip, white, labeled, Printed vertically: consecutive numbers 1 ... 10, 11 ... 20, etc. up to 91 ... 100, mounting type: snapped, for terminal block width: 5.08 mm, lettering field size: 10.5 x 5.15 mm, Number of individual labels: 10

ZB 5,08,LGS:L1-N,PE - Zack marker strip

0809832

<https://www.phoenixcontact.com/us/products/0809832>

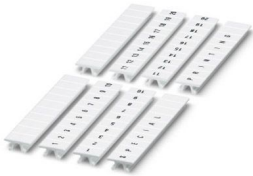

Zack marker strip, Strip, white, labeled, printed horizontally: L1, L2, L3, N, PE, L1, L2, L3, N, PE, mounting type: snapped, for terminal block width: 5.08 mm, lettering field size: 10.5 x 5.15 mm, Number of individual labels: 10

UKK 3-MSTB-5,08 AU 32L - Double-level terminal block



2770969

<https://www.phoenixcontact.com/us/products/2770969>

ZB 5,08,LGS:U-N - Zack marker strip

0809845

<https://www.phoenixcontact.com/us/products/0809845>



Zack marker strip, Strip, white, labeled, printed horizontally: U, V, W, N, GND, U, V, W, N, GND, mounting type: snapped, for terminal block width: 5.08 mm, lettering field size: 10.5 x 5.15 mm, Number of individual labels: 10

CLIPFIX 35 - End bracket

3022218

<https://www.phoenixcontact.com/us/products/3022218>



Quick mounting end clamp for NS 35/7,5 DIN rail or NS 35/15 DIN rail, with marking option, width: 9.5 mm, color: gray

UKK 3-MSTB-5,08 AU 32L - Double-level terminal block



2770969

<https://www.phoenixcontact.com/us/products/2770969>

CLIPFIX 35-5 - End bracket

3022276

<https://www.phoenixcontact.com/us/products/3022276>



Quick mounting end clamp for NS 35/7,5 DIN rail or NS 35/15 DIN rail, with marking option, with parking option for FBS...5, FBS...6, KSS 5, KSS 6, width: 5.15 mm, color: gray

E/NS 35 N - End bracket

0800886

<https://www.phoenixcontact.com/us/products/0800886>

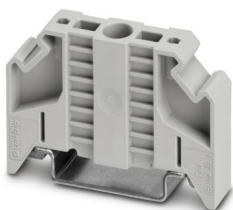

End clamp, width: 9.5 mm, color: gray

UKK 3-MSTB-5,08 AU 32L - Double-level terminal block



2770969

<https://www.phoenixcontact.com/us/products/2770969>

E/UK - End bracket

1201442

<https://www.phoenixcontact.com/us/products/1201442>

End bracket, Mounting on a DIN rail NS 32 or NS 35, material: PA, color: gray



E/UK 1 - End bracket

1201413

<https://www.phoenixcontact.com/us/products/1201413>

End clamps, for supporting the ends of double-level and three-level terminal blocks, width: 10 mm, color: gray



UKK 3-MSTB-5,08 AU 32L - Double-level terminal block

2770969

<https://www.phoenixcontact.com/us/products/2770969>

MSTB 2,5/10-ST-5,08 - PCB connector

1757093

<https://www.phoenixcontact.com/us/products/1757093>

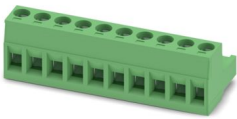

PCB connector, nominal cross section: 2.5 mm², color: green, nominal current: 12 A, rated voltage (III/2): 320 V, contact surface: Tin, contact connection type: Socket, number of potentials: 10, number of rows: 1, number of positions: 10, number of connections: 10, product range: MSTB 2,5/..-ST, pitch: 5.08 mm, connection method: Screw connection with tension sleeve, screw head form: L Slotted, conductor/PCB connection direction: 0 °, locking clip: - Locking clip, plug-in system: COMBICON MSTB 2,5, locking: without, mounting: without, type of packaging: packed in cardboard

MSTB 2,5/11-ST-5,08 - PCB connector

1757103

<https://www.phoenixcontact.com/us/products/1757103>



PCB connector, nominal cross section: 2.5 mm², color: green, nominal current: 12 A, rated voltage (III/2): 320 V, contact surface: Tin, contact connection type: Socket, number of potentials: 11, number of rows: 1, number of positions: 11, number of connections: 11, product range: MSTB 2,5/..-ST, pitch: 5.08 mm, connection method: Screw connection with tension sleeve, screw head form: L Slotted, conductor/PCB connection direction: 0 °, locking clip: - Locking clip, plug-in system: COMBICON MSTB 2,5, locking: without, mounting: without, type of packaging: packed in cardboard

UKK 3-MSTB-5,08 AU 32L - Double-level terminal block

2770969

<https://www.phoenixcontact.com/us/products/2770969>

MSTB 2,5/15-ST-5,08 - PCB connector

1757145

<https://www.phoenixcontact.com/us/products/1757145>

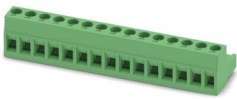

PCB connector, nominal cross section: 2.5 mm², color: green, nominal current: 12 A, rated voltage (III/2): 320 V, contact surface: Tin, contact connection type: Socket, number of potentials: 15, number of rows: 1, number of positions: 15, number of connections: 15, product range: MSTB 2,5/..-ST, pitch: 5.08 mm, connection method: Screw connection with tension sleeve, screw head form: L Slotted, conductor/PCB connection direction: 0 °, locking clip: - Locking clip, plug-in system: COMBICON MSTB 2,5, locking: without, mounting: without, type of packaging: packed in cardboard

MSTB 2,5/16-ST-5,08 - PCB connector

1757158

<https://www.phoenixcontact.com/us/products/1757158>

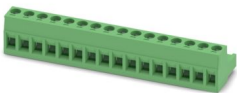

PCB connector, nominal cross section: 2.5 mm², color: green, nominal current: 12 A, rated voltage (III/2): 320 V, contact surface: Tin, contact connection type: Socket, number of potentials: 16, number of rows: 1, number of positions: 16, number of connections: 16, product range: MSTB 2,5/..-ST, pitch: 5.08 mm, connection method: Screw connection with tension sleeve, screw head form: L Slotted, conductor/PCB connection direction: 0 °, locking clip: - Locking clip, plug-in system: COMBICON MSTB 2,5, locking: without, mounting: without, type of packaging: packed in cardboard

UKK 3-MSTB-5,08 AU 32L - Double-level terminal block



2770969

<https://www.phoenixcontact.com/us/products/2770969>

MSTB 2,5/18-ST-5,08 - PCB connector

1757174

<https://www.phoenixcontact.com/us/products/1757174>

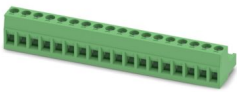

PCB connector, nominal cross section: 2.5 mm², color: green, nominal current: 12 A, rated voltage (III/2): 320 V, contact surface: Tin, contact connection type: Socket, number of potentials: 18, number of rows: 1, number of positions: 18, number of connections: 18, product range: MSTB 2,5/..-ST, pitch: 5.08 mm, connection method: Screw connection with tension sleeve, screw head form: L Slotted, conductor/PCB connection direction: 0 °, locking clip: - Locking clip, plug-in system: COMBICON MSTB 2,5, locking: without, mounting: without, type of packaging: packed in cardboard

MSTB 2,5/20-ST-5,08 - PCB connector

1757190

<https://www.phoenixcontact.com/us/products/1757190>

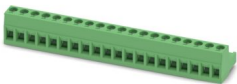

PCB connector, nominal cross section: 2.5 mm², color: green, nominal current: 12 A, rated voltage (III/2): 320 V, contact surface: Tin, contact connection type: Socket, number of potentials: 20, number of rows: 1, number of positions: 20, number of connections: 20, product range: MSTB 2,5/..-ST, pitch: 5.08 mm, connection method: Screw connection with tension sleeve, screw head form: L Slotted, conductor/PCB connection direction: 0 °, locking clip: - Locking clip, plug-in system: COMBICON MSTB 2,5, locking: without, mounting: without, type of packaging: packed in cardboard

UKK 3-MSTB-5,08 AU 32L - Double-level terminal block

2770969

<https://www.phoenixcontact.com/us/products/2770969>

MSTB 2,5/ 2-ST-5,08 - PCB connector

1757019

<https://www.phoenixcontact.com/us/products/1757019>



PCB connector, nominal cross section: 2.5 mm², color: green, nominal current: 12 A, rated voltage (III/2): 320 V, contact surface: Tin, contact connection type: Socket, number of potentials: 2, number of rows: 1, number of positions: 2, number of connections: 2, product range: MSTB 2,5/...-ST, pitch: 5.08 mm, connection method: Screw connection with tension sleeve, screw head form: L Slotted, conductor/PCB connection direction: 0 °, locking clip: - Locking clip, plug-in system: COMBICON MSTB 2,5, locking: without, mounting: without, type of packaging: packed in cardboard

MSTB 2,5/ 9-ST-5,08 - PCB connector

1757080

<https://www.phoenixcontact.com/us/products/1757080>

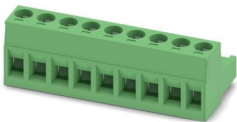

PCB connector, nominal cross section: 2.5 mm², color: green, nominal current: 12 A, rated voltage (III/2): 320 V, contact surface: Tin, contact connection type: Socket, number of potentials: 9, number of rows: 1, number of positions: 9, number of connections: 9, product range: MSTB 2,5/...-ST, pitch: 5.08 mm, connection method: Screw connection with tension sleeve, screw head form: L Slotted, conductor/PCB connection direction: 0 °, locking clip: - Locking clip, plug-in system: COMBICON MSTB 2,5, locking: without, mounting: without, type of packaging: packed in cardboard

UKK 3-MSTB-5,08 AU 32L - Double-level terminal block

2770969

<https://www.phoenixcontact.com/us/products/2770969>

MSTB 2,5/ 7-STZ-5,08 - PCB connector

1776113

<https://www.phoenixcontact.com/us/products/1776113>



PCB connector, nominal cross section: 2.5 mm², color: green, nominal current: 12 A, rated voltage (III/2): 320 V, contact surface: Tin, contact connection type: Socket, number of potentials: 7, number of rows: 1, number of positions: 7, number of connections: 7, product range: MSTB 2,5/...-ST, pitch: 5.08 mm, connection method: Screw connection with tension sleeve, screw head form: L Slotted, conductor/PCB connection direction: 0 °, locking clip: - Locking clip, plug-in system: COMBICON MSTB 2,5, locking: without, mounting: without, type of packaging: packed in cardboard

MSTB 2,5/ 5-STZ-5,08 - PCB connector

1776142

<https://www.phoenixcontact.com/us/products/1776142>



PCB connector, nominal cross section: 2.5 mm², color: green, nominal current: 12 A, rated voltage (III/2): 320 V, contact surface: Tin, contact connection type: Socket, number of potentials: 5, number of rows: 1, number of positions: 5, number of connections: 5, product range: MSTB 2,5/...-ST, pitch: 5.08 mm, connection method: Screw connection with tension sleeve, screw head form: L Slotted, conductor/PCB connection direction: 0 °, locking clip: - Locking clip, plug-in system: COMBICON MSTB 2,5, locking: without, mounting: without, type of packaging: packed in cardboard

UKK 3-MSTB-5,08 AU 32L - Double-level terminal block

2770969

<https://www.phoenixcontact.com/us/products/2770969>

MSTB 2,5/ 4-STZ-5,08 - PCB connector

1776155

<https://www.phoenixcontact.com/us/products/1776155>



PCB connector, nominal cross section: 2.5 mm², color: green, nominal current: 12 A, rated voltage (III/2): 320 V, contact surface: Tin, contact connection type: Socket, number of potentials: 4, number of rows: 1, number of positions: 4, number of connections: 4, product range: MSTB 2,5/...-ST, pitch: 5.08 mm, connection method: Screw connection with tension sleeve, screw head form: L Slotted, conductor/PCB connection direction: 0 °, locking clip: - Locking clip, plug-in system: COMBICON MSTB 2,5, locking: without, mounting: without, type of packaging: packed in cardboard

MSTB 2,5/12-STZ-5,08 - PCB connector

1764280

<https://www.phoenixcontact.com/us/products/1764280>



PCB connector, nominal cross section: 2.5 mm², color: green, nominal current: 12 A, rated voltage (III/2): 320 V, contact surface: Tin, contact connection type: Socket, number of potentials: 12, number of rows: 1, number of positions: 12, number of connections: 12, product range: MSTB 2,5/...-ST, pitch: 5.08 mm, connection method: Screw connection with tension sleeve, screw head form: L Slotted, conductor/PCB connection direction: 0 °, locking clip: - Locking clip, plug-in system: COMBICON MSTB 2,5, locking: without, mounting: without, type of packaging: packed in cardboard

UKK 3-MSTB-5,08 AU 32L - Double-level terminal block

2770969

<https://www.phoenixcontact.com/us/products/2770969>

MSTB 2,5/ 6-STZ-5,08 - PCB connector

1776126

<https://www.phoenixcontact.com/us/products/1776126>



PCB connector, nominal cross section: 2.5 mm², color: green, nominal current: 12 A, rated voltage (III/2): 320 V, contact surface: Tin, contact connection type: Socket, number of potentials: 6, number of rows: 1, number of positions: 6, number of connections: 6, product range: MSTB 2,5/...-ST, pitch: 5.08 mm, connection method: Screw connection with tension sleeve, screw head form: L Slotted, conductor/PCB connection direction: 0 °, locking clip: - Locking clip, plug-in system: COMBICON MSTB 2,5, locking: without, mounting: without, type of packaging: packed in cardboard

MSTB 2,5/16-STZ-5,08 - PCB connector

1764248

<https://www.phoenixcontact.com/us/products/1764248>



PCB connector, nominal cross section: 2.5 mm², color: green, nominal current: 12 A, rated voltage (III/2): 320 V, contact surface: Tin, contact connection type: Socket, number of potentials: 16, number of rows: 1, number of positions: 16, number of connections: 16, product range: MSTB 2,5/...-ST, pitch: 5.08 mm, connection method: Screw connection with tension sleeve, screw head form: L Slotted, conductor/PCB connection direction: 0 °, locking clip: - Locking clip, plug-in system: COMBICON MSTB 2,5, locking: without, mounting: without, type of packaging: packed in cardboard

UKK 3-MSTB-5,08 AU 32L - Double-level terminal block

2770969

<https://www.phoenixcontact.com/us/products/2770969>

MSTB 2,5/ 9-STZ-5,08 - PCB connector

1764316

<https://www.phoenixcontact.com/us/products/1764316>



PCB connector, nominal cross section: 2.5 mm², color: green, nominal current: 12 A, rated voltage (III/2): 320 V, contact surface: Tin, contact connection type: Socket, number of potentials: 9, number of rows: 1, number of positions: 9, number of connections: 9, product range: MSTB 2,5/...-ST, pitch: 5.08 mm, connection method: Screw connection with tension sleeve, screw head form: L Slotted, conductor/PCB connection direction: 0 °, locking clip: - Locking clip, plug-in system: COMBICON MSTB 2,5, locking: without, mounting: without, type of packaging: packed in cardboard

MSTBP 2,5/ 4-ST-5,08 - PCB connector

1769036

<https://www.phoenixcontact.com/us/products/1769036>



PCB connector, nominal cross section: 2.5 mm², color: green, nominal current: 12 A, rated voltage (III/2): 320 V, contact surface: Tin, contact connection type: Socket, number of potentials: 4, number of rows: 1, number of positions: 4, number of connections: 4, product range: MSTBP 2,5/...-ST, pitch: 5.08 mm, connection method: Screw connection with tension sleeve, screw head form: L Slotted, conductor/PCB connection direction: 0 °, locking clip: - Locking clip, plug-in system: COMBICON MSTB 2,5, locking: without, mounting: without, type of packaging: packed in cardboard

UKK 3-MSTB-5,08 AU 32L - Double-level terminal block

2770969

<https://www.phoenixcontact.com/us/products/2770969>

MSTBP 2,5/16-ST-5,08 - PCB connector

1769159

<https://www.phoenixcontact.com/us/products/1769159>



PCB connector, nominal cross section: 2.5 mm², color: green, nominal current: 12 A, rated voltage (III/2): 320 V, contact surface: Tin, contact connection type: Socket, number of potentials: 16, number of rows: 1, number of positions: 16, number of connections: 16, product range: MSTBP 2,5/...-ST, pitch: 5.08 mm, connection method: Screw connection with tension sleeve, screw head form: L Slotted, conductor/PCB connection direction: 0 °, locking clip: - Locking clip, plug-in system: COMBICON MSTB 2,5, locking: without, mounting: without, type of packaging: packed in cardboard

MSTBP 2,5/ 6-ST-5,08 - PCB connector

1769052

<https://www.phoenixcontact.com/us/products/1769052>



PCB connector, nominal cross section: 2.5 mm², color: green, nominal current: 12 A, rated voltage (III/2): 320 V, contact surface: Tin, contact connection type: Socket, number of potentials: 6, number of rows: 1, number of positions: 6, number of connections: 6, product range: MSTBP 2,5/...-ST, pitch: 5.08 mm, connection method: Screw connection with tension sleeve, screw head form: L Slotted, conductor/PCB connection direction: 0 °, locking clip: - Locking clip, plug-in system: COMBICON MSTB 2,5, locking: without, mounting: without, type of packaging: packed in cardboard

UKK 3-MSTB-5,08 AU 32L - Double-level terminal block



2770969

<https://www.phoenixcontact.com/us/products/2770969>

MSTBP 2,5/17-ST-5,08 - PCB connector

1769162

<https://www.phoenixcontact.com/us/products/1769162>

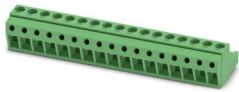

PCB connector, nominal cross section: 2.5 mm², color: green, nominal current: 12 A, rated voltage (III/2): 320 V, contact surface: Tin, contact connection type: Socket, number of potentials: 17, number of rows: 1, number of positions: 17, number of connections: 17, product range: MSTBP 2,5/...-ST, pitch: 5.08 mm, connection method: Screw connection with tension sleeve, screw head form: L Slotted, conductor/PCB connection direction: 0 °, locking clip: - Locking clip, plug-in system: COMBICON MSTB 2,5, locking: without, mounting: without, type of packaging: packed in cardboard

MSTBP 2,5/24-ST-5,08 - PCB connector

1769696

<https://www.phoenixcontact.com/us/products/1769696>



PCB connector, nominal cross section: 2.5 mm², color: green, nominal current: 12 A, rated voltage (III/2): 320 V, contact surface: Tin, contact connection type: Socket, number of potentials: 24, number of rows: 1, number of positions: 24, number of connections: 24, product range: MSTBP 2,5/...-ST, pitch: 5.08 mm, connection method: Screw connection with tension sleeve, screw head form: L Slotted, conductor/PCB connection direction: 0 °, locking clip: - Locking clip, plug-in system: COMBICON MSTB 2,5, locking: without, mounting: without, type of packaging: packed in cardboard

UKK 3-MSTB-5,08 AU 32L - Double-level terminal block



2770969

<https://www.phoenixcontact.com/us/products/2770969>

MSTBP 2,5/ 8-ST-5,08 - PCB connector

1769078

<https://www.phoenixcontact.com/us/products/1769078>



PCB connector, nominal cross section: 2.5 mm², color: green, nominal current: 12 A, rated voltage (III/2): 320 V, contact surface: Tin, contact connection type: Socket, number of potentials: 8, number of rows: 1, number of positions: 8, number of connections: 8, product range: MSTBP 2,5/..-ST, pitch: 5.08 mm, connection method: Screw connection with tension sleeve, screw head form: L Slotted, conductor/PCB connection direction: 0 °, locking clip: - Locking clip, plug-in system: COMBICON MSTB 2,5, locking: without, mounting: without, type of packaging: packed in cardboard

MSTBP 2,5/ 9-ST-5,08 - PCB connector

1769081

<https://www.phoenixcontact.com/us/products/1769081>



PCB connector, nominal cross section: 2.5 mm², color: green, nominal current: 12 A, rated voltage (III/2): 320 V, contact surface: Tin, contact connection type: Socket, number of potentials: 9, number of rows: 1, number of positions: 9, number of connections: 9, product range: MSTBP 2,5/..-ST, pitch: 5.08 mm, connection method: Screw connection with tension sleeve, screw head form: L Slotted, conductor/PCB connection direction: 0 °, locking clip: - Locking clip, plug-in system: COMBICON MSTB 2,5, locking: without, mounting: without, type of packaging: packed in cardboard

UKK 3-MSTB-5,08 AU 32L - Double-level terminal block

2770969

<https://www.phoenixcontact.com/us/products/2770969>

MSTBP 2,5/13-ST-5,08 - PCB connector

1769120

<https://www.phoenixcontact.com/us/products/1769120>



PCB connector, nominal cross section: 2.5 mm², color: green, nominal current: 12 A, rated voltage (III/2): 320 V, contact surface: Tin, contact connection type: Socket, number of potentials: 13, number of rows: 1, number of positions: 13, number of connections: 13, product range: MSTBP 2,5/...-ST, pitch: 5.08 mm, connection method: Screw connection with tension sleeve, screw head form: L Slotted, conductor/PCB connection direction: 0 °, locking clip: - Locking clip, plug-in system: COMBICON MSTB 2,5, locking: without, mounting: without, type of packaging: packed in cardboard

MSTBP 2,5/20-ST-5,08 - PCB connector

1769191

<https://www.phoenixcontact.com/us/products/1769191>



PCB connector, nominal cross section: 2.5 mm², color: green, nominal current: 12 A, rated voltage (III/2): 320 V, contact surface: Tin, contact connection type: Socket, number of potentials: 20, number of rows: 1, number of positions: 20, number of connections: 20, product range: MSTBP 2,5/...-ST, pitch: 5.08 mm, connection method: Screw connection with tension sleeve, screw head form: L Slotted, conductor/PCB connection direction: 0 °, locking clip: - Locking clip, plug-in system: COMBICON MSTB 2,5, locking: without, mounting: without, type of packaging: packed in cardboard

UKK 3-MSTB-5,08 AU 32L - Double-level terminal block

2770969

<https://www.phoenixcontact.com/us/products/2770969>

MSTBT 2,5/15-ST-5,08 - PCB connector

1781111

<https://www.phoenixcontact.com/us/products/1781111>

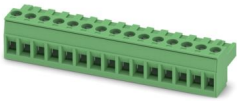

PCB connector, nominal cross section: 2.5 mm², color: green, nominal current: 12 A, rated voltage (III/2): 320 V, contact surface: Tin, contact connection type: Socket, number of potentials: 15, number of rows: 1, number of positions: 15, number of connections: 15, product range: MSTBT 2,5/...-ST, pitch: 5.08 mm, connection method: Screw connection with tension sleeve, screw head form: L Slotted, conductor/PCB connection direction: 0 °, locking clip: - Locking clip, plug-in system: COMBICON MSTB 2,5, locking: without, mounting: without, type of packaging: packed in cardboard

MSTBT 2,5/ 3-ST-5,08 - PCB connector

1779990

<https://www.phoenixcontact.com/us/products/1779990>



PCB connector, nominal cross section: 2.5 mm², color: green, nominal current: 12 A, rated voltage (III/2): 320 V, contact surface: Tin, contact connection type: Socket, number of potentials: 3, number of rows: 1, number of positions: 3, number of connections: 3, product range: MSTBT 2,5/...-ST, pitch: 5.08 mm, connection method: Screw connection with tension sleeve, screw head form: L Slotted, conductor/PCB connection direction: 0 °, locking clip: - Locking clip, plug-in system: COMBICON MSTB 2,5, locking: without, mounting: without, type of packaging: packed in cardboard

UKK 3-MSTB-5,08 AU 32L - Double-level terminal block

2770969

<https://www.phoenixcontact.com/us/products/2770969>

MSTBT 2,5/16-ST-5,08 - PCB connector

1781124

<https://www.phoenixcontact.com/us/products/1781124>



PCB connector, nominal cross section: 2.5 mm², color: green, nominal current: 12 A, rated voltage (III/2): 320 V, contact surface: Tin, contact connection type: Socket, number of potentials: 16, number of rows: 1, number of positions: 16, number of connections: 16, product range: MSTBT 2,5/...-ST, pitch: 5.08 mm, connection method: Screw connection with tension sleeve, screw head form: L Slotted, conductor/PCB connection direction: 0 °, locking clip: - Locking clip, plug-in system: COMBICON MSTB 2,5, locking: without, mounting: without, type of packaging: packed in cardboard

SMSTB 2,5/ 4-ST-5,08 - PCB connector

1826306

<https://www.phoenixcontact.com/us/products/1826306>



PCB connector, nominal cross section: 2.5 mm², color: green, nominal current: 12 A, rated voltage (III/2): 320 V, contact surface: Tin, contact connection type: Socket, number of potentials: 4, number of rows: 1, number of positions: 4, number of connections: 4, product range: SMSTB 2,5/...-ST, pitch: 5.08 mm, connection method: Screw connection with tension sleeve, screw head form: L Slotted, conductor/PCB connection direction: -45 °, locking clip: - Locking clip, plug-in system: COMBICON MSTB 2,5, locking: without, mounting: without, type of packaging: packed in cardboard

UKK 3-MSTB-5,08 AU 32L - Double-level terminal block

2770969

<https://www.phoenixcontact.com/us/products/2770969>

SMSTB 2,5/ 5-ST-5,08 - PCB connector

1826319

<https://www.phoenixcontact.com/us/products/1826319>



PCB connector, nominal cross section: 2.5 mm², color: green, nominal current: 12 A, rated voltage (III/2): 320 V, contact surface: Tin, contact connection type: Socket, number of potentials: 5, number of rows: 1, number of positions: 5, number of connections: 5, product range: SMSTB 2,5/..-ST, pitch: 5.08 mm, connection method: Screw connection with tension sleeve, screw head form: L Slotted, conductor/PCB connection direction: -45 °, locking clip: - Locking clip, plug-in system: COMBICON MSTB 2,5, locking: without, mounting: without, type of packaging: packed in cardboard

SMSTB 2,5/10-ST-5,08 - PCB connector

1826364

<https://www.phoenixcontact.com/us/products/1826364>



PCB connector, nominal cross section: 2.5 mm², color: green, nominal current: 12 A, rated voltage (III/2): 320 V, contact surface: Tin, contact connection type: Socket, number of potentials: 10, number of rows: 1, number of positions: 10, number of connections: 10, product range: SMSTB 2,5/..-ST, pitch: 5.08 mm, connection method: Screw connection with tension sleeve, screw head form: L Slotted, conductor/PCB connection direction: -45 °, locking clip: - Locking clip, plug-in system: COMBICON MSTB 2,5, locking: without, mounting: without, type of packaging: packed in cardboard

UKK 3-MSTB-5,08 AU 32L - Double-level terminal block

2770969

<https://www.phoenixcontact.com/us/products/2770969>

SMSTB 2,5/12-ST-5,08 - PCB connector

1826380

<https://www.phoenixcontact.com/us/products/1826380>



PCB connector, nominal cross section: 2.5 mm², color: green, nominal current: 12 A, rated voltage (III/2): 320 V, contact surface: Tin, contact connection type: Socket, number of potentials: 12, number of rows: 1, number of positions: 12, number of connections: 12, product range: SMSTB 2,5/...-ST, pitch: 5.08 mm, connection method: Screw connection with tension sleeve, screw head form: L Slotted, conductor/PCB connection direction: -45 °, locking clip: - Locking clip, plug-in system: COMBICON MSTB 2,5, locking: without, mounting: without, type of packaging: packed in cardboard

SMSTB 2,5/15-ST-5,08 - PCB connector

1826416

<https://www.phoenixcontact.com/us/products/1826416>



PCB connector, nominal cross section: 2.5 mm², color: green, nominal current: 12 A, rated voltage (III/2): 320 V, contact surface: Tin, contact connection type: Socket, number of potentials: 15, number of rows: 1, number of positions: 15, number of connections: 15, product range: SMSTB 2,5/...-ST, pitch: 5.08 mm, connection method: Screw connection with tension sleeve, screw head form: L Slotted, conductor/PCB connection direction: -45 °, locking clip: - Locking clip, plug-in system: COMBICON MSTB 2,5, locking: without, mounting: without, type of packaging: packed in cardboard

UKK 3-MSTB-5,08 AU 32L - Double-level terminal block

2770969

<https://www.phoenixcontact.com/us/products/2770969>

SMSTB 2,5/16-ST-5,08 - PCB connector

1826429

<https://www.phoenixcontact.com/us/products/1826429>



PCB connector, nominal cross section: 2.5 mm², color: green, nominal current: 12 A, rated voltage (III/2): 320 V, contact surface: Tin, contact connection type: Socket, number of potentials: 16, number of rows: 1, number of positions: 16, number of connections: 16, product range: SMSTB 2,5/...-ST, pitch: 5.08 mm, connection method: Screw connection with tension sleeve, screw head form: L Slotted, conductor/PCB connection direction: -45 °, locking clip: - Locking clip, plug-in system: COMBICON MSTB 2,5, locking: without, mounting: without, type of packaging: packed in cardboard

SMSTB 2,5/19-ST-5,08 - PCB connector

1850589

<https://www.phoenixcontact.com/us/products/1850589>



PCB connector, nominal cross section: 2.5 mm², color: green, nominal current: 12 A, rated voltage (III/2): 320 V, contact surface: Tin, contact connection type: Socket, number of potentials: 19, number of rows: 1, number of positions: 19, number of connections: 19, product range: SMSTB 2,5/...-ST, pitch: 5.08 mm, connection method: Screw connection with tension sleeve, screw head form: L Slotted, conductor/PCB connection direction: -45 °, locking clip: - Locking clip, plug-in system: COMBICON MSTB 2,5, locking: without, mounting: without, type of packaging: packed in cardboard

UKK 3-MSTB-5,08 AU 32L - Double-level terminal block

2770969

<https://www.phoenixcontact.com/us/products/2770969>

SMSTB 2,5/20-ST-5,08 - PCB connector

1850592

<https://www.phoenixcontact.com/us/products/1850592>



PCB connector, nominal cross section: 2.5 mm², color: green, nominal current: 12 A, rated voltage (III/2): 320 V, contact surface: Tin, contact connection type: Socket, number of potentials: 20, number of rows: 1, number of positions: 20, number of connections: 20, product range: SMSTB 2,5/...-ST, pitch: 5.08 mm, connection method: Screw connection with tension sleeve, screw head form: L Slotted, conductor/PCB connection direction: -45 °, locking clip: - Locking clip, plug-in system: COMBICON MSTB 2,5, locking: without, mounting: without, type of packaging: packed in cardboard

SMSTB 2,5/23-ST-5,08 - PCB connector

1850628

<https://www.phoenixcontact.com/us/products/1850628>



PCB connector, nominal cross section: 2.5 mm², color: green, nominal current: 12 A, rated voltage (III/2): 320 V, contact surface: Tin, contact connection type: Socket, number of potentials: 23, number of rows: 1, number of positions: 23, number of connections: 23, product range: SMSTB 2,5/...-ST, pitch: 5.08 mm, connection method: Screw connection with tension sleeve, screw head form: L Slotted, conductor/PCB connection direction: -45 °, locking clip: - Locking clip, plug-in system: COMBICON MSTB 2,5, locking: without, mounting: without, type of packaging: packed in cardboard

UKK 3-MSTB-5,08 AU 32L - Double-level terminal block

2770969

<https://www.phoenixcontact.com/us/products/2770969>

SMSTB 2,5/21-ST-5,08 - PCB connector

1850602

<https://www.phoenixcontact.com/us/products/1850602>



PCB connector, nominal cross section: 2.5 mm², color: green, nominal current: 12 A, rated voltage (III/2): 320 V, contact surface: Tin, contact connection type: Socket, number of potentials: 21, number of rows: 1, number of positions: 21, number of connections: 21, product range: SMSTB 2,5/...-ST, pitch: 5.08 mm, connection method: Screw connection with tension sleeve, screw head form: L Slotted, conductor/PCB connection direction: -45 °, locking clip: - Locking clip, plug-in system: COMBICON MSTB 2,5, locking: without, mounting: without, type of packaging: packed in cardboard

SMSTB 2,5/14-ST-5,08 - PCB connector

1826403

<https://www.phoenixcontact.com/us/products/1826403>



PCB connector, nominal cross section: 2.5 mm², color: green, nominal current: 12 A, rated voltage (III/2): 320 V, contact surface: Tin, contact connection type: Socket, number of potentials: 14, number of rows: 1, number of positions: 14, number of connections: 14, product range: SMSTB 2,5/...-ST, pitch: 5.08 mm, connection method: Screw connection with tension sleeve, screw head form: L Slotted, conductor/PCB connection direction: -45 °, locking clip: - Locking clip, plug-in system: COMBICON MSTB 2,5, locking: without, mounting: without, type of packaging: packed in cardboard

UKK 3-MSTB-5,08 AU 32L - Double-level terminal block



2770969

<https://www.phoenixcontact.com/us/products/2770969>

SMSTB 2,5/ 7-ST-5,08 - PCB connector

1826335

<https://www.phoenixcontact.com/us/products/1826335>



PCB connector, nominal cross section: 2.5 mm², color: green, nominal current: 12 A, rated voltage (III/2): 320 V, contact surface: Tin, contact connection type: Socket, number of potentials: 7, number of rows: 1, number of positions: 7, number of connections: 7, product range: SMSTB 2,5/..-ST, pitch: 5.08 mm, connection method: Screw connection with tension sleeve, screw head form: L Slotted, conductor/PCB connection direction: -45 °, locking clip: - Locking clip, plug-in system: COMBICON MSTB 2,5, locking: without, mounting: without, type of packaging: packed in cardboard

SMSTB 2,5/17-ST-5,08 - PCB connector

1850563

<https://www.phoenixcontact.com/us/products/1850563>



PCB connector, nominal cross section: 2.5 mm², color: green, nominal current: 12 A, rated voltage (III/2): 320 V, contact surface: Tin, contact connection type: Socket, number of potentials: 17, number of rows: 1, number of positions: 17, number of connections: 17, product range: SMSTB 2,5/..-ST, pitch: 5.08 mm, connection method: Screw connection with tension sleeve, screw head form: L Slotted, conductor/PCB connection direction: -45 °, locking clip: - Locking clip, plug-in system: COMBICON MSTB 2,5, locking: without, mounting: without, type of packaging: packed in cardboard

UKK 3-MSTB-5,08 AU 32L - Double-level terminal block



2770969

<https://www.phoenixcontact.com/us/products/2770969>

SMSTB 2,5/ 2-ST-5,08 - PCB connector

1826283

<https://www.phoenixcontact.com/us/products/1826283>



PCB connector, nominal cross section: 2.5 mm², color: green, nominal current: 12 A, rated voltage (III/2): 320 V, contact surface: Tin, contact connection type: Socket, number of potentials: 2, number of rows: 1, number of positions: 2, number of connections: 2, product range: SMSTB 2,5/..-ST, pitch: 5.08 mm, connection method: Screw connection with tension sleeve, screw head form: L Slotted, conductor/PCB connection direction: -45 °, locking clip: - Locking clip, plug-in system: COMBICON MSTB 2,5, locking: without, mounting: without, type of packaging: packed in cardboard

SMSTB 2,5/ 3-ST-5,08 - PCB connector

1826296

<https://www.phoenixcontact.com/us/products/1826296>



PCB connector, nominal cross section: 2.5 mm², color: green, nominal current: 12 A, rated voltage (III/2): 320 V, contact surface: Tin, contact connection type: Socket, number of potentials: 3, number of rows: 1, number of positions: 3, number of connections: 3, product range: SMSTB 2,5/..-ST, pitch: 5.08 mm, connection method: Screw connection with tension sleeve, screw head form: L Slotted, conductor/PCB connection direction: -45 °, locking clip: - Locking clip, plug-in system: COMBICON MSTB 2,5, locking: without, mounting: without, type of packaging: packed in cardboard

UKK 3-MSTB-5,08 AU 32L - Double-level terminal block



2770969

<https://www.phoenixcontact.com/us/products/2770969>

SMSTB 2,5/ 6-ST-5,08 - PCB connector

1826322

<https://www.phoenixcontact.com/us/products/1826322>



PCB connector, nominal cross section: 2.5 mm², color: green, nominal current: 12 A, rated voltage (III/2): 320 V, contact surface: Tin, contact connection type: Socket, number of potentials: 6, number of rows: 1, number of positions: 6, number of connections: 6, product range: SMSTB 2,5/..-ST, pitch: 5.08 mm, connection method: Screw connection with tension sleeve, screw head form: L Slotted, conductor/PCB connection direction: -45 °, locking clip: - Locking clip, plug-in system: COMBICON MSTB 2,5, locking: without, mounting: without, type of packaging: packed in cardboard

SMSTB 2,5/22-ST-5,08 - PCB connector

1850615

<https://www.phoenixcontact.com/us/products/1850615>



PCB connector, nominal cross section: 2.5 mm², color: green, nominal current: 12 A, rated voltage (III/2): 320 V, contact surface: Tin, contact connection type: Socket, number of potentials: 22, number of rows: 1, number of positions: 22, number of connections: 22, product range: SMSTB 2,5/..-ST, pitch: 5.08 mm, connection method: Screw connection with tension sleeve, screw head form: L Slotted, conductor/PCB connection direction: -45 °, locking clip: - Locking clip, plug-in system: COMBICON MSTB 2,5, locking: without, mounting: without, type of packaging: packed in cardboard

UKK 3-MSTB-5,08 AU 32L - Double-level terminal block

2770969

<https://www.phoenixcontact.com/us/products/2770969>

SMSTB 2,5/24-ST-5,08 - PCB connector

1850631

<https://www.phoenixcontact.com/us/products/1850631>



PCB connector, nominal cross section: 2.5 mm², color: green, nominal current: 12 A, rated voltage (III/2): 320 V, contact surface: Tin, contact connection type: Socket, number of potentials: 24, number of rows: 1, number of positions: 24, number of connections: 24, product range: SMSTB 2,5/...-ST, pitch: 5.08 mm, connection method: Screw connection with tension sleeve, screw head form: L Slotted, conductor/PCB connection direction: -45 °, locking clip: - Locking clip, plug-in system: COMBICON MSTB 2,5, locking: without, mounting: without, type of packaging: packed in cardboard

FRONT-MSTB 2,5/ 2-ST-5,08 - PCB connector

1777280

<https://www.phoenixcontact.com/us/products/1777280>

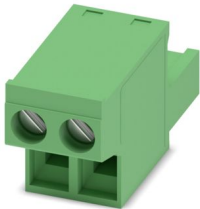

PCB connector, nominal cross section: 2.5 mm², color: green, nominal current: 12 A, rated voltage (III/2): 320 V, contact surface: Tin, contact connection type: Socket, number of potentials: 2, number of rows: 1, number of positions: 2, number of connections: 2, product range: FRONT-MSTB 2,5/...-ST, pitch: 5.08 mm, connection method: Front screw connection, screw head form: L Slotted, conductor/PCB connection direction: 0 °, locking clip: - Locking clip, plug-in system: COMBICON MSTB 2,5, locking: without, mounting: without, type of packaging: packed in cardboard

UKK 3-MSTB-5,08 AU 32L - Double-level terminal block

2770969

<https://www.phoenixcontact.com/us/products/2770969>

FRONT-MSTB 2,5/ 6-ST-5,08 - PCB connector

1777329

<https://www.phoenixcontact.com/us/products/1777329>

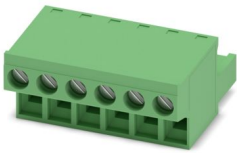

PCB connector, nominal cross section: 2.5 mm², color: green, nominal current: 12 A, rated voltage (III/2): 320 V, contact surface: Tin, contact connection type: Socket, number of potentials: 6, number of rows: 1, number of positions: 6, number of connections: 6, product range: FRONT-MSTB 2,5/..-ST, pitch: 5.08 mm, connection method: Front screw connection, screw head form: L Slotted, conductor/PCB connection direction: 0 °, locking clip: - Locking clip, plug-in system: COMBICON MSTB 2,5, locking: without, mounting: without, type of packaging: packed in cardboard

FRONT-MSTB 2,5/ 8-ST-5,08 - PCB connector

1777345

<https://www.phoenixcontact.com/us/products/1777345>

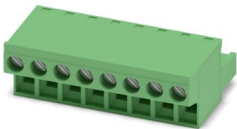

PCB connector, nominal cross section: 2.5 mm², color: green, nominal current: 12 A, rated voltage (III/2): 320 V, contact surface: Tin, contact connection type: Socket, number of potentials: 8, number of rows: 1, number of positions: 8, number of connections: 8, product range: FRONT-MSTB 2,5/..-ST, pitch: 5.08 mm, connection method: Front screw connection, screw head form: L Slotted, conductor/PCB connection direction: 0 °, locking clip: - Locking clip, plug-in system: COMBICON MSTB 2,5, locking: without, mounting: without, type of packaging: packed in cardboard

UKK 3-MSTB-5,08 AU 32L - Double-level terminal block

2770969

<https://www.phoenixcontact.com/us/products/2770969>

FRONT-MSTB 2,5/10-ST-5,08 - PCB connector

1777361

<https://www.phoenixcontact.com/us/products/1777361>

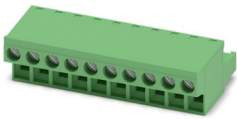

PCB connector, nominal cross section: 2.5 mm², color: green, nominal current: 12 A, rated voltage (III/2): 320 V, contact surface: Tin, contact connection type: Socket, number of potentials: 10, number of rows: 1, number of positions: 10, number of connections: 10, product range: FRONT-MSTB 2,5/...-ST, pitch: 5.08 mm, connection method: Front screw connection, screw head form: L Slotted, conductor/PCB connection direction: 0 °, locking clip: - Locking clip, plug-in system: COMBICON MSTB 2,5, locking: without, mounting: without, type of packaging: packed in cardboard

FRONT-MSTB 2,5/13-ST-5,08 - PCB connector

1777390

<https://www.phoenixcontact.com/us/products/1777390>

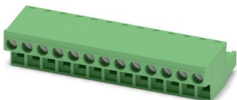

PCB connector, nominal cross section: 2.5 mm², color: green, nominal current: 12 A, rated voltage (III/2): 320 V, contact surface: Tin, contact connection type: Socket, number of potentials: 13, number of rows: 1, number of positions: 13, number of connections: 13, product range: FRONT-MSTB 2,5/...-ST, pitch: 5.08 mm, connection method: Front screw connection, screw head form: L Slotted, conductor/PCB connection direction: 0 °, locking clip: - Locking clip, plug-in system: COMBICON MSTB 2,5, locking: without, mounting: without, type of packaging: packed in cardboard

UKK 3-MSTB-5,08 AU 32L - Double-level terminal block



2770969

<https://www.phoenixcontact.com/us/products/2770969>

FRONT-MSTB 2,5/14-ST-5,08 - PCB connector

1777400

<https://www.phoenixcontact.com/us/products/1777400>

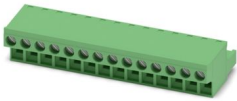

PCB connector, nominal cross section: 2.5 mm², color: green, nominal current: 12 A, rated voltage (III/2): 320 V, contact surface: Tin, contact connection type: Socket, number of potentials: 14, number of rows: 1, number of positions: 14, number of connections: 14, product range: FRONT-MSTB 2,5/...-ST, pitch: 5.08 mm, connection method: Front screw connection, screw head form: L Slotted, conductor/PCB connection direction: 0 °, locking clip: - Locking clip, plug-in system: COMBICON MSTB 2,5, locking: without, mounting: without, type of packaging: packed in cardboard

FRONT-MSTB 2,5/16-ST-5,08 - PCB connector

1777426

<https://www.phoenixcontact.com/us/products/1777426>

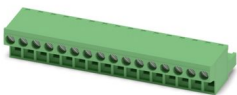

PCB connector, nominal cross section: 2.5 mm², color: green, nominal current: 12 A, rated voltage (III/2): 320 V, contact surface: Tin, contact connection type: Socket, number of potentials: 16, number of rows: 1, number of positions: 16, number of connections: 16, product range: FRONT-MSTB 2,5/...-ST, pitch: 5.08 mm, connection method: Front screw connection, screw head form: L Slotted, conductor/PCB connection direction: 0 °, locking clip: - Locking clip, plug-in system: COMBICON MSTB 2,5, locking: without, mounting: without, type of packaging: packed in cardboard

UKK 3-MSTB-5,08 AU 32L - Double-level terminal block

2770969

<https://www.phoenixcontact.com/us/products/2770969>

FRONT-MSTB 2,5/22-ST-5,08 - PCB connector

1777484

<https://www.phoenixcontact.com/us/products/1777484>



PCB connector, nominal cross section: 2.5 mm², color: green, nominal current: 12 A, rated voltage (III/2): 320 V, contact surface: Tin, contact connection type: Socket, number of potentials: 22, number of rows: 1, number of positions: 22, number of connections: 22, product range: FRONT-MSTB 2,5/...-ST, pitch: 5.08 mm, connection method: Front screw connection, screw head form: L Slotted, conductor/PCB connection direction: 0 °, locking clip: - Locking clip, plug-in system: COMBICON MSTB 2,5, locking: without, mounting: without, type of packaging: packed in cardboard

FRONT-MSTB 2,5/24-ST-5,08 - PCB connector

1777507

<https://www.phoenixcontact.com/us/products/1777507>



PCB connector, nominal cross section: 2.5 mm², color: green, nominal current: 12 A, rated voltage (III/2): 320 V, contact surface: Tin, contact connection type: Socket, number of potentials: 24, number of rows: 1, number of positions: 24, number of connections: 24, product range: FRONT-MSTB 2,5/...-ST, pitch: 5.08 mm, connection method: Front screw connection, screw head form: L Slotted, conductor/PCB connection direction: 0 °, locking clip: - Locking clip, plug-in system: COMBICON MSTB 2,5, locking: without, mounting: without, type of packaging: packed in cardboard

UKK 3-MSTB-5,08 AU 32L - Double-level terminal block

2770969

<https://www.phoenixcontact.com/us/products/2770969>

FRONT-MSTB 2,5/11-ST-5,08 - PCB connector

1777374

<https://www.phoenixcontact.com/us/products/1777374>

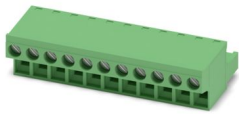

PCB connector, nominal cross section: 2.5 mm², color: green, nominal current: 12 A, rated voltage (III/2): 320 V, contact surface: Tin, contact connection type: Socket, number of potentials: 11, number of rows: 1, number of positions: 11, number of connections: 11, product range: FRONT-MSTB 2,5/...-ST, pitch: 5.08 mm, connection method: Front screw connection, screw head form: L Slotted, conductor/PCB connection direction: 0 °, locking clip: - Locking clip, plug-in system: COMBICON MSTB 2,5, locking: without, mounting: without, type of packaging: packed in cardboard

FRONT-MSTB 2,5/17-ST-5,08 - PCB connector

1777439

<https://www.phoenixcontact.com/us/products/1777439>



PCB connector, nominal cross section: 2.5 mm², color: green, nominal current: 12 A, rated voltage (III/2): 320 V, contact surface: Tin, contact connection type: Socket, number of potentials: 17, number of rows: 1, number of positions: 17, number of connections: 17, product range: FRONT-MSTB 2,5/...-ST, pitch: 5.08 mm, connection method: Front screw connection, screw head form: L Slotted, conductor/PCB connection direction: 0 °, locking clip: - Locking clip, plug-in system: COMBICON MSTB 2,5, locking: without, mounting: without, type of packaging: packed in cardboard

UKK 3-MSTB-5,08 AU 32L - Double-level terminal block

2770969

<https://www.phoenixcontact.com/us/products/2770969>

FRONT-MSTB 2,5/ 3-ST-5,08 - PCB connector

1777293

<https://www.phoenixcontact.com/us/products/1777293>

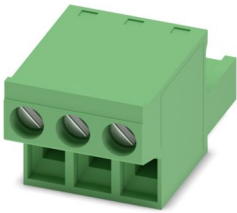

PCB connector, nominal cross section: 2.5 mm², color: green, nominal current: 12 A, rated voltage (III/2): 320 V, contact surface: Tin, contact connection type: Socket, number of potentials: 3, number of rows: 1, number of positions: 3, number of connections: 3, product range: FRONT-MSTB 2,5/..-ST, pitch: 5.08 mm, connection method: Front screw connection, screw head form: L Slotted, conductor/PCB connection direction: 0 °, locking clip: - Locking clip, plug-in system: COMBICON MSTB 2,5, locking: without, mounting: without, type of packaging: packed in cardboard

FRONT-MSTB 2,5/19-ST-5,08 - PCB connector

1777455

<https://www.phoenixcontact.com/us/products/1777455>



PCB connector, nominal cross section: 2.5 mm², color: green, nominal current: 12 A, rated voltage (III/2): 320 V, contact surface: Tin, contact connection type: Socket, number of potentials: 19, number of rows: 1, number of positions: 19, number of connections: 19, product range: FRONT-MSTB 2,5/..-ST, pitch: 5.08 mm, connection method: Front screw connection, screw head form: L Slotted, conductor/PCB connection direction: 0 °, locking clip: - Locking clip, plug-in system: COMBICON MSTB 2,5, locking: without, mounting: without, type of packaging: packed in cardboard

UKK 3-MSTB-5,08 AU 32L - Double-level terminal block



2770969

<https://www.phoenixcontact.com/us/products/2770969>

FRONT-MSTB 2,5/21-ST-5,08 - PCB connector

1777471

<https://www.phoenixcontact.com/us/products/1777471>

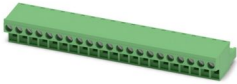

PCB connector, nominal cross section: 2.5 mm², color: green, nominal current: 12 A, rated voltage (III/2): 320 V, contact surface: Tin, contact connection type: Socket, number of potentials: 21, number of rows: 1, number of positions: 21, number of connections: 21, product range: FRONT-MSTB 2,5/...-ST, pitch: 5.08 mm, connection method: Front screw connection, screw head form: L Slotted, conductor/PCB connection direction: 0 °, locking clip: - Locking clip, plug-in system: COMBICON MSTB 2,5, locking: without, mounting: without, type of packaging: packed in cardboard

FRONT-MSTB 2,5/15-ST-5,08 - PCB connector

1777413

<https://www.phoenixcontact.com/us/products/1777413>



PCB connector, nominal cross section: 2.5 mm², color: green, nominal current: 12 A, rated voltage (III/2): 320 V, contact surface: Tin, contact connection type: Socket, number of potentials: 15, number of rows: 1, number of positions: 15, number of connections: 15, product range: FRONT-MSTB 2,5/...-ST, pitch: 5.08 mm, connection method: Front screw connection, screw head form: L Slotted, conductor/PCB connection direction: 0 °, locking clip: - Locking clip, plug-in system: COMBICON MSTB 2,5, locking: without, mounting: without, type of packaging: packed in cardboard

UKK 3-MSTB-5,08 AU 32L - Double-level terminal block

2770969

<https://www.phoenixcontact.com/us/products/2770969>

FRONT-MSTB 2,5/ 4-ST-5,08 - PCB connector

1777303

<https://www.phoenixcontact.com/us/products/1777303>



PCB connector, nominal cross section: 2.5 mm², color: green, nominal current: 12 A, rated voltage (III/2): 320 V, contact surface: Tin, contact connection type: Socket, number of potentials: 4, number of rows: 1, number of positions: 4, number of connections: 4, product range: FRONT-MSTB 2,5/..-ST, pitch: 5.08 mm, connection method: Front screw connection, screw head form: L Slotted, conductor/PCB connection direction: 0 °, locking clip: - Locking clip, plug-in system: COMBICON MSTB 2,5, locking: without, mounting: without, type of packaging: packed in cardboard

FRONT-MSTB 2,5/ 5-ST-5,08 - PCB connector

1777316

<https://www.phoenixcontact.com/us/products/1777316>

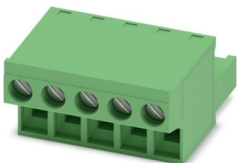

PCB connector, nominal cross section: 2.5 mm², color: green, nominal current: 12 A, rated voltage (III/2): 320 V, contact surface: Tin, contact connection type: Socket, number of potentials: 5, number of rows: 1, number of positions: 5, number of connections: 5, product range: FRONT-MSTB 2,5/..-ST, pitch: 5.08 mm, connection method: Front screw connection, screw head form: L Slotted, conductor/PCB connection direction: 0 °, locking clip: - Locking clip, plug-in system: COMBICON MSTB 2,5, locking: without, mounting: without, type of packaging: packed in cardboard

UKK 3-MSTB-5,08 AU 32L - Double-level terminal block

2770969

<https://www.phoenixcontact.com/us/products/2770969>

FRONT-MSTB 2,5/ 9-ST-5,08 - PCB connector

1777358

<https://www.phoenixcontact.com/us/products/1777358>

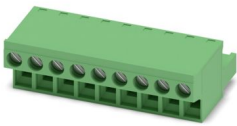

PCB connector, nominal cross section: 2.5 mm², color: green, nominal current: 12 A, rated voltage (III/2): 320 V, contact surface: Tin, contact connection type: Socket, number of potentials: 9, number of rows: 1, number of positions: 9, number of connections: 9, product range: FRONT-MSTB 2,5/..-ST, pitch: 5.08 mm, connection method: Front screw connection, screw head form: L Slotted, conductor/PCB connection direction: 0 °, locking clip: - Locking clip, plug-in system: COMBICON MSTB 2,5, locking: without, mounting: without, type of packaging: packed in cardboard

FRONT-MSTB 2,5/12-ST-5,08 - PCB connector

1777387

<https://www.phoenixcontact.com/us/products/1777387>

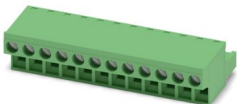

PCB connector, nominal cross section: 2.5 mm², color: green, nominal current: 12 A, rated voltage (III/2): 320 V, contact surface: Tin, contact connection type: Socket, number of potentials: 12, number of rows: 1, number of positions: 12, number of connections: 12, product range: FRONT-MSTB 2,5/..-ST, pitch: 5.08 mm, connection method: Front screw connection, screw head form: L Slotted, conductor/PCB connection direction: 0 °, locking clip: - Locking clip, plug-in system: COMBICON MSTB 2,5, locking: without, mounting: without, type of packaging: packed in cardboard

UKK 3-MSTB-5,08 AU 32L - Double-level terminal block

2770969

<https://www.phoenixcontact.com/us/products/2770969>

FRONT-MSTB 2,5/18-ST-5,08 - PCB connector

1777442

<https://www.phoenixcontact.com/us/products/1777442>



PCB connector, nominal cross section: 2.5 mm², color: green, nominal current: 12 A, rated voltage (III/2): 320 V, contact surface: Tin, contact connection type: Socket, number of potentials: 18, number of rows: 1, number of positions: 18, number of connections: 18, product range: FRONT-MSTB 2,5/...-ST, pitch: 5.08 mm, connection method: Front screw connection, screw head form: L Slotted, conductor/PCB connection direction: 0 °, locking clip: - Locking clip, plug-in system: COMBICON MSTB 2,5, locking: without, mounting: without, type of packaging: packed in cardboard

FRONT-MSTB 2,5/20-ST-5,08 - PCB connector

1777468

<https://www.phoenixcontact.com/us/products/1777468>

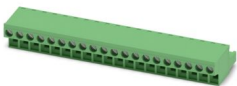

PCB connector, nominal cross section: 2.5 mm², color: green, nominal current: 12 A, rated voltage (III/2): 320 V, contact surface: Tin, contact connection type: Socket, number of potentials: 20, number of rows: 1, number of positions: 20, number of connections: 20, product range: FRONT-MSTB 2,5/...-ST, pitch: 5.08 mm, connection method: Front screw connection, screw head form: L Slotted, conductor/PCB connection direction: 0 °, locking clip: - Locking clip, plug-in system: COMBICON MSTB 2,5, locking: without, mounting: without, type of packaging: packed in cardboard

UKK 3-MSTB-5,08 AU 32L - Double-level terminal block

2770969

<https://www.phoenixcontact.com/us/products/2770969>

FRONT-MSTB 2,5/23-ST-5,08 - PCB connector

1777497

<https://www.phoenixcontact.com/us/products/1777497>



PCB connector, nominal cross section: 2.5 mm², color: green, nominal current: 12 A, rated voltage (III/2): 320 V, contact surface: Tin, contact connection type: Socket, number of rows: 1, number of positions: 23, product range: FRONT-MSTB 2,5/...-ST, pitch: 5.08 mm, connection method: Front screw connection, screw head form: L Slotted, conductor/PCB connection direction: 0 °, locking clip: - Locking clip, plug-in system: COMBICON MSTB 2,5, locking: without, mounting: without, type of packaging: packed in cardboard

FRONT-MSTB 2,5/ 8-STF-5,08 - PCB connector

1777798

<https://www.phoenixcontact.com/us/products/1777798>



PCB connector, nominal cross section: 2.5 mm², color: green, nominal current: 12 A, rated voltage (III/2): 320 V, contact surface: Tin, contact connection type: Socket, number of potentials: 8, number of rows: 1, number of positions: 8, number of connections: 8, product range: FRONT-MSTB 2,5/...-STF, pitch: 5.08 mm, connection method: Front screw connection, screw head form: L Slotted, conductor/PCB connection direction: 0 °, locking clip: - Locking clip, plug-in system: COMBICON MSTB 2,5, locking: Screw locking mechanism, mounting: Screw flange, type of packaging: packed in cardboard

UKK 3-MSTB-5,08 AU 32L - Double-level terminal block

2770969

<https://www.phoenixcontact.com/us/products/2770969>

FRONT-MSTB 2,5/ 5-STF-5,08 - PCB connector

1777837

<https://www.phoenixcontact.com/us/products/1777837>



PCB connector, nominal cross section: 2.5 mm², color: green, nominal current: 12 A, rated voltage (III/2): 320 V, contact surface: Tin, contact connection type: Socket, number of potentials: 5, number of rows: 1, number of positions: 5, number of connections: 5, product range: FRONT-MSTB 2,5/...-STF, pitch: 5.08 mm, connection method: Front screw connection, screw head form: L Slotted, conductor/PCB connection direction: 0 °, locking clip: - Locking clip, plug-in system: COMBICON MSTB 2,5, locking: Screw locking mechanism, mounting: Screw flange, type of packaging: packed in cardboard

FRONT-MSTB 2,5/ 6-STF-5,08 - PCB connector

1777840

<https://www.phoenixcontact.com/us/products/1777840>



PCB connector, nominal cross section: 2.5 mm², color: green, nominal current: 12 A, rated voltage (III/2): 320 V, contact surface: Tin, contact connection type: Socket, number of potentials: 6, number of rows: 1, number of positions: 6, number of connections: 6, product range: FRONT-MSTB 2,5/...-STF, pitch: 5.08 mm, connection method: Front screw connection, screw head form: L Slotted, conductor/PCB connection direction: 0 °, locking clip: - Locking clip, plug-in system: COMBICON MSTB 2,5, locking: Screw locking mechanism, mounting: Screw flange, type of packaging: packed in cardboard

UKK 3-MSTB-5,08 AU 32L - Double-level terminal block

2770969

<https://www.phoenixcontact.com/us/products/2770969>

FRONT-MSTB 2,5/ 9-STF-5,08 - PCB connector

1777866

<https://www.phoenixcontact.com/us/products/1777866>



PCB connector, nominal cross section: 2.5 mm², color: green, nominal current: 12 A, rated voltage (III/2): 320 V, contact surface: Tin, contact connection type: Socket, number of potentials: 9, number of rows: 1, number of positions: 9, number of connections: 9, product range: FRONT-MSTB 2,5/...-STF, pitch: 5.08 mm, connection method: Front screw connection, screw head form: L Slotted, conductor/PCB connection direction: 0 °, locking clip: - Locking clip, plug-in system: COMBICON MSTB 2,5, locking: Screw locking mechanism, mounting: Screw flange, type of packaging: packed in cardboard

FRONT-MSTB 2,5/11-STF-5,08 - PCB connector

1777882

<https://www.phoenixcontact.com/us/products/1777882>



PCB connector, nominal cross section: 2.5 mm², color: green, nominal current: 12 A, rated voltage (III/2): 320 V, contact surface: Tin, contact connection type: Socket, number of potentials: 11, number of rows: 1, number of positions: 11, number of connections: 11, product range: FRONT-MSTB 2,5/...-STF, pitch: 5.08 mm, connection method: Front screw connection, screw head form: L Slotted, conductor/PCB connection direction: 0 °, locking clip: - Locking clip, plug-in system: COMBICON MSTB 2,5, locking: Screw locking mechanism, mounting: Screw flange, type of packaging: packed in cardboard

UKK 3-MSTB-5,08 AU 32L - Double-level terminal block

2770969

<https://www.phoenixcontact.com/us/products/2770969>

FRONT-MSTB 2,5/12-STF-5,08 - PCB connector

1777895

<https://www.phoenixcontact.com/us/products/1777895>



PCB connector, nominal cross section: 2.5 mm², color: green, nominal current: 12 A, rated voltage (III/2): 320 V, contact surface: Tin, contact connection type: Socket, number of potentials: 12, number of rows: 1, number of positions: 12, number of connections: 12, product range: FRONT-MSTB 2,5/..-STF, pitch: 5.08 mm, connection method: Front screw connection, screw head form: L Slotted, conductor/PCB connection direction: 0 °, locking clip: - Locking clip, plug-in system: COMBICON MSTB 2,5, locking: Screw locking mechanism, mounting: Screw flange, type of packaging: packed in cardboard

FRONT-MSTB 2,5/13-STF-5,08 - PCB connector

1777905

<https://www.phoenixcontact.com/us/products/1777905>



PCB connector, nominal cross section: 2.5 mm², color: green, nominal current: 12 A, rated voltage (III/2): 320 V, contact surface: Tin, contact connection type: Socket, number of potentials: 13, number of rows: 1, number of positions: 13, number of connections: 13, product range: FRONT-MSTB 2,5/..-STF, pitch: 5.08 mm, connection method: Front screw connection, screw head form: L Slotted, conductor/PCB connection direction: 0 °, locking clip: - Locking clip, plug-in system: COMBICON MSTB 2,5, locking: Screw locking mechanism, mounting: Screw flange, type of packaging: packed in cardboard

UKK 3-MSTB-5,08 AU 32L - Double-level terminal block

2770969

<https://www.phoenixcontact.com/us/products/2770969>

FRONT-MSTB 2,5/16-STF-5,08 - PCB connector

1777934

<https://www.phoenixcontact.com/us/products/1777934>

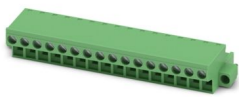

PCB connector, nominal cross section: 2.5 mm², color: green, nominal current: 12 A, rated voltage (III/2): 320 V, contact surface: Tin, contact connection type: Socket, number of potentials: 16, number of rows: 1, number of positions: 16, number of connections: 16, product range: FRONT-MSTB 2,5/..-STF, pitch: 5.08 mm, connection method: Front screw connection, screw head form: L Slotted, conductor/PCB connection direction: 0 °, locking clip: - Locking clip, plug-in system: COMBICON MSTB 2,5, locking: Screw locking mechanism, mounting: Screw flange, type of packaging: packed in cardboard

FRONT-MSTB 2,5/20-STF-5,08 - PCB connector

1777976

<https://www.phoenixcontact.com/us/products/1777976>



PCB connector, nominal cross section: 2.5 mm², color: green, nominal current: 12 A, rated voltage (III/2): 320 V, contact surface: Tin, contact connection type: Socket, number of potentials: 20, number of rows: 1, number of positions: 20, number of connections: 20, product range: FRONT-MSTB 2,5/..-STF, pitch: 5.08 mm, connection method: Front screw connection, screw head form: L Slotted, conductor/PCB connection direction: 0 °, locking clip: - Locking clip, plug-in system: COMBICON MSTB 2,5, locking: Screw locking mechanism, mounting: Screw flange, type of packaging: packed in cardboard

UKK 3-MSTB-5,08 AU 32L - Double-level terminal block

2770969

<https://www.phoenixcontact.com/us/products/2770969>

FRONT-MSTB 2,5/ 3-STF-5,08 - PCB connector

1777811

<https://www.phoenixcontact.com/us/products/1777811>



PCB connector, nominal cross section: 2.5 mm², color: green, nominal current: 12 A, rated voltage (III/2): 320 V, contact surface: Tin, contact connection type: Socket, number of potentials: 3, number of rows: 1, number of positions: 3, number of connections: 3, product range: FRONT-MSTB 2,5/...-STF, pitch: 5.08 mm, connection method: Front screw connection, screw head form: L Slotted, conductor/PCB connection direction: 0 °, locking clip: - Locking clip, plug-in system: COMBICON MSTB 2,5, locking: Screw locking mechanism, mounting: Screw flange, type of packaging: packed in cardboard

FRONT-MSTB 2,5/18-STF-5,08 - PCB connector

1777950

<https://www.phoenixcontact.com/us/products/1777950>



PCB connector, nominal cross section: 2.5 mm², color: green, nominal current: 12 A, rated voltage (III/2): 320 V, contact surface: Tin, contact connection type: Socket, number of potentials: 18, number of rows: 1, number of positions: 18, number of connections: 18, product range: FRONT-MSTB 2,5/...-STF, pitch: 5.08 mm, connection method: Front screw connection, screw head form: L Slotted, conductor/PCB connection direction: 0 °, locking clip: - Locking clip, plug-in system: COMBICON MSTB 2,5, locking: Screw locking mechanism, mounting: Screw flange, type of packaging: packed in cardboard

UKK 3-MSTB-5,08 AU 32L - Double-level terminal block

2770969

<https://www.phoenixcontact.com/us/products/2770969>

FRONT-MSTB 2,5/ 7-STF-5,08 - PCB connector

1777853

<https://www.phoenixcontact.com/us/products/1777853>



PCB connector, nominal cross section: 2.5 mm², color: green, nominal current: 12 A, rated voltage (III/2): 320 V, contact surface: Tin, contact connection type: Socket, number of potentials: 7, number of rows: 1, number of positions: 7, number of connections: 7, product range: FRONT-MSTB 2,5/...-STF, pitch: 5.08 mm, connection method: Front screw connection, screw head form: L Slotted, conductor/PCB connection direction: 0 °, locking clip: - Locking clip, plug-in system: COMBICON MSTB 2,5, locking: Screw locking mechanism, mounting: Screw flange, type of packaging: packed in cardboard

FRONT-MSTB 2,5/19-STF-5,08 - PCB connector

1777963

<https://www.phoenixcontact.com/us/products/1777963>



PCB connector, nominal cross section: 2.5 mm², color: green, nominal current: 12 A, rated voltage (III/2): 320 V, contact surface: Tin, contact connection type: Socket, number of potentials: 19, number of rows: 1, number of positions: 19, number of connections: 19, product range: FRONT-MSTB 2,5/...-STF, pitch: 5.08 mm, connection method: Front screw connection, screw head form: L Slotted, conductor/PCB connection direction: 0 °, locking clip: - Locking clip, plug-in system: COMBICON MSTB 2,5, locking: Screw locking mechanism, mounting: Screw flange, type of packaging: packed in cardboard

UKK 3-MSTB-5,08 AU 32L - Double-level terminal block

2770969

<https://www.phoenixcontact.com/us/products/2770969>

FRONT-MSTB 2,5/17-STF-5,08 - PCB connector

1777947

<https://www.phoenixcontact.com/us/products/1777947>



PCB connector, nominal cross section: 2.5 mm², color: green, nominal current: 12 A, rated voltage (III/2): 320 V, contact surface: Tin, contact connection type: Socket, number of potentials: 17, number of rows: 1, number of positions: 17, number of connections: 17, product range: FRONT-MSTB 2,5/..-STF, pitch: 5.08 mm, connection method: Front screw connection, screw head form: L Slotted, conductor/PCB connection direction: 0 °, locking clip: - Locking clip, plug-in system: COMBICON MSTB 2,5, locking: Screw locking mechanism, mounting: Screw flange, type of packaging: packed in cardboard

FRONT-MSTB 2,5/14-STF-5,08 - PCB connector

1777918

<https://www.phoenixcontact.com/us/products/1777918>



PCB connector, nominal cross section: 2.5 mm², color: green, nominal current: 12 A, rated voltage (III/2): 320 V, contact surface: Tin, contact connection type: Socket, number of potentials: 14, number of rows: 1, number of positions: 14, number of connections: 14, product range: FRONT-MSTB 2,5/..-STF, pitch: 5.08 mm, connection method: Front screw connection, screw head form: L Slotted, conductor/PCB connection direction: 0 °, locking clip: - Locking clip, plug-in system: COMBICON MSTB 2,5, locking: Screw locking mechanism, mounting: Screw flange, type of packaging: packed in cardboard

UKK 3-MSTB-5,08 AU 32L - Double-level terminal block

2770969

<https://www.phoenixcontact.com/us/products/2770969>

FRONT-MSTB 2,5/ 4-STF-5,08 - PCB connector

1777824

<https://www.phoenixcontact.com/us/products/1777824>



PCB connector, nominal cross section: 2.5 mm², color: green, nominal current: 12 A, rated voltage (III/2): 320 V, contact surface: Tin, contact connection type: Socket, number of potentials: 4, number of rows: 1, number of positions: 4, number of connections: 4, product range: FRONT-MSTB 2,5/...-STF, pitch: 5.08 mm, connection method: Front screw connection, screw head form: L Slotted, conductor/PCB connection direction: 0 °, locking clip: - Locking clip, plug-in system: COMBICON MSTB 2,5, locking: Screw locking mechanism, mounting: Screw flange, type of packaging: packed in cardboard

FRONT-MSTB 2,5/10-STF-5,08 - PCB connector

1777879

<https://www.phoenixcontact.com/us/products/1777879>



PCB connector, nominal cross section: 2.5 mm², color: green, nominal current: 12 A, rated voltage (III/2): 320 V, contact surface: Tin, contact connection type: Socket, number of potentials: 10, number of rows: 1, number of positions: 10, number of connections: 10, product range: FRONT-MSTB 2,5/...-STF, pitch: 5.08 mm, connection method: Front screw connection, screw head form: L Slotted, conductor/PCB connection direction: 0 °, locking clip: - Locking clip, plug-in system: COMBICON MSTB 2,5, locking: Screw locking mechanism, mounting: Screw flange, type of packaging: packed in cardboard

UKK 3-MSTB-5,08 AU 32L - Double-level terminal block

2770969

<https://www.phoenixcontact.com/us/products/2770969>

FRONT-MSTB 2,5/15-STF-5,08 - PCB connector

1777921

<https://www.phoenixcontact.com/us/products/1777921>



PCB connector, nominal cross section: 2.5 mm², color: green, nominal current: 12 A, rated voltage (III/2): 320 V, contact surface: Tin, contact connection type: Socket, number of potentials: 15, number of rows: 1, number of positions: 15, number of connections: 15, product range: FRONT-MSTB 2,5/...-STF, pitch: 5.08 mm, connection method: Front screw connection, screw head form: L Slotted, conductor/PCB connection direction: 0 °, locking clip: - Locking clip, plug-in system: COMBICON MSTB 2,5, locking: Screw locking mechanism, mounting: Screw flange, type of packaging: packed in cardboard

FRONT-MSTB 2,5/ 2-STF-5,08 - PCB connector

1777808

<https://www.phoenixcontact.com/us/products/1777808>



PCB connector, nominal cross section: 2.5 mm², color: green, nominal current: 12 A, rated voltage (III/2): 320 V, contact surface: Tin, contact connection type: Socket, number of potentials: 2, number of rows: 1, number of positions: 2, number of connections: 2, product range: FRONT-MSTB 2,5/...-STF, pitch: 5.08 mm, connection method: Front screw connection, screw head form: L Slotted, conductor/PCB connection direction: 0 °, locking clip: - Locking clip, plug-in system: COMBICON MSTB 2,5, locking: Screw locking mechanism, mounting: Screw flange, type of packaging: packed in cardboard

UKK 3-MSTB-5,08 AU 32L - Double-level terminal block

2770969

<https://www.phoenixcontact.com/us/products/2770969>

FKC 2,5/ 4-ST-5,08 - PCB connector

1873074

<https://www.phoenixcontact.com/us/products/1873074>

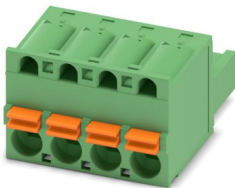

PCB connector, nominal cross section: 2.5 mm², color: green, nominal current: 12 A, rated voltage (III/2): 320 V, contact surface: Tin, contact connection type: Socket, number of potentials: 4, number of rows: 1, number of positions: 4, number of connections: 4, product range: FKC 2,5/..-ST, pitch: 5.08 mm, connection method: Push-in spring connection, conductor/PCB connection direction: 0 °, locking clip: - Locking clip, plug-in system: COMBICON MSTB 2,5, locking: without, mounting: without, type of packaging: packed in cardboard

FKC 2,5/ 5-ST-5,08 - PCB connector

1873087

<https://www.phoenixcontact.com/us/products/1873087>

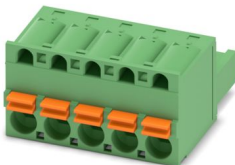

PCB connector, nominal cross section: 2.5 mm², color: green, nominal current: 12 A, rated voltage (III/2): 320 V, contact surface: Tin, contact connection type: Socket, number of potentials: 5, number of rows: 1, number of positions: 5, number of connections: 5, product range: FKC 2,5/..-ST, pitch: 5.08 mm, connection method: Push-in spring connection, conductor/PCB connection direction: 0 °, locking clip: - Locking clip, plug-in system: COMBICON MSTB 2,5, locking: without, mounting: without, type of packaging: packed in cardboard

UKK 3-MSTB-5,08 AU 32L - Double-level terminal block

2770969

<https://www.phoenixcontact.com/us/products/2770969>

FKC 2,5/ 7-ST-5,08 - PCB connector

1873100

<https://www.phoenixcontact.com/us/products/1873100>

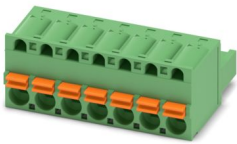

PCB connector, nominal cross section: 2.5 mm², color: green, nominal current: 12 A, rated voltage (III/2): 320 V, contact surface: Tin, contact connection type: Socket, number of potentials: 7, number of rows: 1, number of positions: 7, number of connections: 7, product range: FKC 2,5/..-ST, pitch: 5.08 mm, connection method: Push-in spring connection, conductor/PCB connection direction: 0 °, locking clip: - Locking clip, plug-in system: COMBICON MSTB 2,5, locking: without, mounting: without, type of packaging: packed in cardboard

FKC 2,5/ 8-ST-5,08 - PCB connector

1873113

<https://www.phoenixcontact.com/us/products/1873113>

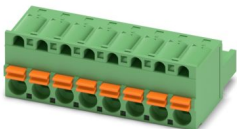

PCB connector, nominal cross section: 2.5 mm², color: green, nominal current: 12 A, rated voltage (III/2): 320 V, contact surface: Tin, contact connection type: Socket, number of potentials: 8, number of rows: 1, number of positions: 8, number of connections: 8, product range: FKC 2,5/..-ST, pitch: 5.08 mm, connection method: Push-in spring connection, conductor/PCB connection direction: 0 °, locking clip: - Locking clip, plug-in system: COMBICON MSTB 2,5, locking: without, mounting: without, type of packaging: packed in cardboard

UKK 3-MSTB-5,08 AU 32L - Double-level terminal block



2770969

<https://www.phoenixcontact.com/us/products/2770969>

FKC 2,5/10-ST-5,08 - PCB connector

1873139

<https://www.phoenixcontact.com/us/products/1873139>

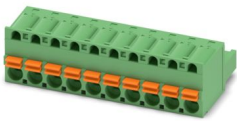

PCB connector, nominal cross section: 2.5 mm², color: green, nominal current: 12 A, rated voltage (III/2): 320 V, contact surface: Tin, contact connection type: Socket, number of potentials: 10, number of rows: 1, number of positions: 10, number of connections: 10, product range: FKC 2,5/..-ST, pitch: 5.08 mm, connection method: Push-in spring connection, conductor/PCB connection direction: 0 °, locking clip: - Locking clip, plug-in system: COMBICON MSTB 2,5, locking: without, mounting: without, type of packaging: packed in cardboard

FKC 2,5/12-ST-5,08 - PCB connector

1873155

<https://www.phoenixcontact.com/us/products/1873155>



PCB connector, nominal cross section: 2.5 mm², color: green, nominal current: 12 A, rated voltage (III/2): 320 V, contact surface: Tin, contact connection type: Socket, number of potentials: 12, number of rows: 1, number of positions: 12, number of connections: 12, product range: FKC 2,5/..-ST, pitch: 5.08 mm, connection method: Push-in spring connection, conductor/PCB connection direction: 0 °, locking clip: - Locking clip, plug-in system: COMBICON MSTB 2,5, locking: without, mounting: without, type of packaging: packed in cardboard

UKK 3-MSTB-5,08 AU 32L - Double-level terminal block



2770969

<https://www.phoenixcontact.com/us/products/2770969>

FKC 2,5/13-ST-5,08 - PCB connector

1873168

<https://www.phoenixcontact.com/us/products/1873168>

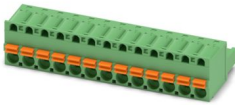

PCB connector, nominal cross section: 2.5 mm², color: green, nominal current: 12 A, rated voltage (III/2): 320 V, contact surface: Tin, contact connection type: Socket, number of potentials: 13, number of rows: 1, number of positions: 13, number of connections: 13, product range: FKC 2,5/..-ST, pitch: 5.08 mm, connection method: Push-in spring connection, conductor/PCB connection direction: 0 °, locking clip: - Locking clip, plug-in system: COMBICON MSTB 2,5, locking: without, mounting: without, type of packaging: packed in cardboard

FKC 2,5/16-ST-5,08 - PCB connector

1873197

<https://www.phoenixcontact.com/us/products/1873197>

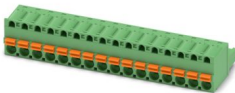

PCB connector, nominal cross section: 2.5 mm², color: green, nominal current: 12 A, rated voltage (III/2): 320 V, contact surface: Tin, contact connection type: Socket, number of potentials: 16, number of rows: 1, number of positions: 16, number of connections: 16, product range: FKC 2,5/..-ST, pitch: 5.08 mm, connection method: Push-in spring connection, conductor/PCB connection direction: 0 °, locking clip: - Locking clip, plug-in system: COMBICON MSTB 2,5, locking: without, mounting: without, type of packaging: packed in cardboard

UKK 3-MSTB-5,08 AU 32L - Double-level terminal block

2770969

<https://www.phoenixcontact.com/us/products/2770969>

FKC 2,5/ 3-ST-5,08 - PCB connector

1873061

<https://www.phoenixcontact.com/us/products/1873061>

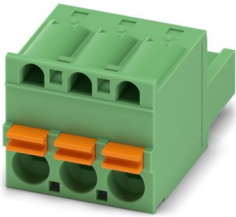

PCB connector, nominal cross section: 2.5 mm², color: green, nominal current: 12 A, rated voltage (III/2): 320 V, contact surface: Tin, contact connection type: Socket, number of potentials: 3, number of rows: 1, number of positions: 3, number of connections: 3, product range: FKC 2,5/..-ST, pitch: 5.08 mm, connection method: Push-in spring connection, conductor/PCB connection direction: 0 °, locking clip: - Locking clip, plug-in system: COMBICON MSTB 2,5, locking: without, mounting: without, type of packaging: packed in cardboard

FKC 2,5/ 9-ST-5,08 - PCB connector

1873126

<https://www.phoenixcontact.com/us/products/1873126>

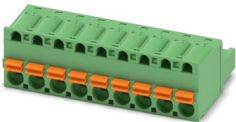

PCB connector, nominal cross section: 2.5 mm², color: green, nominal current: 12 A, rated voltage (III/2): 320 V, contact surface: Tin, contact connection type: Socket, number of potentials: 9, number of rows: 1, number of positions: 9, number of connections: 9, product range: FKC 2,5/..-ST, pitch: 5.08 mm, connection method: Push-in spring connection, conductor/PCB connection direction: 0 °, locking clip: - Locking clip, plug-in system: COMBICON MSTB 2,5, locking: without, mounting: without, type of packaging: packed in cardboard

UKK 3-MSTB-5,08 AU 32L - Double-level terminal block

2770969

<https://www.phoenixcontact.com/us/products/2770969>

FKC 2,5/14-ST-5,08 - PCB connector

1873171

<https://www.phoenixcontact.com/us/products/1873171>

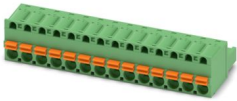

PCB connector, nominal cross section: 2.5 mm², color: green, nominal current: 12 A, rated voltage (III/2): 320 V, contact surface: Tin, contact connection type: Socket, number of potentials: 14, number of rows: 1, number of positions: 14, number of connections: 14, product range: FKC 2,5/..-ST, pitch: 5.08 mm, connection method: Push-in spring connection, conductor/PCB connection direction: 0 °, locking clip: - Locking clip, plug-in system: COMBICON MSTB 2,5, locking: without, mounting: without, type of packaging: packed in cardboard

FKC 2,5/ 6-ST-5,08 - PCB connector

1873090

<https://www.phoenixcontact.com/us/products/1873090>

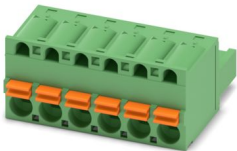

PCB connector, nominal cross section: 2.5 mm², color: green, nominal current: 12 A, rated voltage (III/2): 320 V, contact surface: Tin, contact connection type: Socket, number of potentials: 6, number of rows: 1, number of positions: 6, number of connections: 6, product range: FKC 2,5/..-ST, pitch: 5.08 mm, connection method: Push-in spring connection, conductor/PCB connection direction: 0 °, locking clip: - Locking clip, plug-in system: COMBICON MSTB 2,5, locking: without, mounting: without, type of packaging: packed in cardboard

UKK 3-MSTB-5,08 AU 32L - Double-level terminal block

2770969

<https://www.phoenixcontact.com/us/products/2770969>

FKC 2,5/11-ST-5,08 - PCB connector

1873142

<https://www.phoenixcontact.com/us/products/1873142>

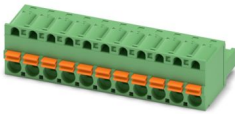

PCB connector, nominal cross section: 2.5 mm², color: green, nominal current: 12 A, rated voltage (III/2): 320 V, contact surface: Tin, contact connection type: Socket, number of potentials: 11, number of rows: 1, number of positions: 11, number of connections: 11, product range: FKC 2,5/..-ST, pitch: 5.08 mm, connection method: Push-in spring connection, conductor/PCB connection direction: 0 °, locking clip: - Locking clip, plug-in system: COMBICON MSTB 2,5, locking: without, mounting: without, type of packaging: packed in cardboard

FKC 2,5/15-ST-5,08 - PCB connector

1873184

<https://www.phoenixcontact.com/us/products/1873184>

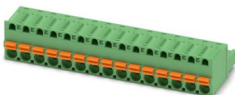

PCB connector, nominal cross section: 2.5 mm², color: green, nominal current: 12 A, rated voltage (III/2): 320 V, contact surface: Tin, contact connection type: Socket, number of potentials: 15, number of rows: 1, number of positions: 15, number of connections: 15, product range: FKC 2,5/..-ST, pitch: 5.08 mm, connection method: Push-in spring connection, conductor/PCB connection direction: 0 °, locking clip: - Locking clip, plug-in system: COMBICON MSTB 2,5, locking: without, mounting: without, type of packaging: packed in cardboard

UKK 3-MSTB-5,08 AU 32L - Double-level terminal block

2770969

<https://www.phoenixcontact.com/us/products/2770969>

FKC 2,5/ 2-ST-5,08 - PCB connector

1873058

<https://www.phoenixcontact.com/us/products/1873058>



PCB connector, nominal cross section: 2.5 mm², color: green, nominal current: 12 A, rated voltage (III/2): 320 V, contact surface: Tin, contact connection type: Socket, number of potentials: 2, number of rows: 1, number of positions: 2, number of connections: 2, product range: FKC 2,5/..-ST, pitch: 5.08 mm, connection method: Push-in spring connection, conductor/PCB connection direction: 0 °, locking clip: - Locking clip, plug-in system: COMBICON MSTB 2,5, locking: without, mounting: without, type of packaging: packed in cardboard

QC 1/ 2-ST-5,08 - PCB connector

1883255

<https://www.phoenixcontact.com/us/products/1883255>

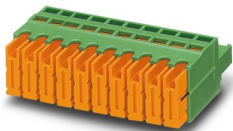

PCB connector, nominal cross section: 1 mm², color: green, nominal current: 10 A, rated voltage (III/2): 630 V, contact surface: Tin, contact connection type: Socket, number of potentials: 2, number of rows: 1, number of positions: 2, number of connections: 2, product range: QC 1/..-ST, pitch: 5.08 mm, connection method: Displacement connection, conductor/PCB connection direction: 0 °, locking clip: - Locking clip, plug-in system: COMBICON MSTB 2,5, locking: without, mounting: without, type of packaging: packed in cardboard

UKK 3-MSTB-5,08 AU 32L - Double-level terminal block

2770969

<https://www.phoenixcontact.com/us/products/2770969>

QC 1/ 5-ST-5,08 - PCB connector

1883284

<https://www.phoenixcontact.com/us/products/1883284>

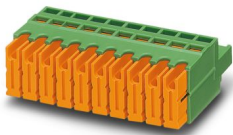

PCB connector, nominal cross section: 1 mm², color: green, nominal current: 10 A, rated voltage (III/2): 630 V, contact surface: Tin, contact connection type: Socket, number of potentials: 5, number of rows: 1, number of positions: 5, number of connections: 5, product range: QC 1/..-ST, pitch: 5.08 mm, connection method: Displacement connection, conductor/PCB connection direction: 0 °, locking clip: - Locking clip, plug-in system: COMBICON MSTB 2,5, locking: without, mounting: without, type of packaging: packed in cardboard

QC 1/ 6-ST-5,08 - PCB connector

1883297

<https://www.phoenixcontact.com/us/products/1883297>

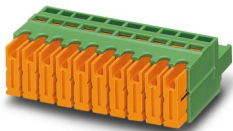

PCB connector, nominal cross section: 1 mm², color: green, nominal current: 10 A, rated voltage (III/2): 630 V, contact surface: Tin, contact connection type: Socket, number of potentials: 6, number of rows: 1, number of positions: 6, number of connections: 6, product range: QC 1/..-ST, pitch: 5.08 mm, connection method: Displacement connection, conductor/PCB connection direction: 0 °, locking clip: - Locking clip, plug-in system: COMBICON MSTB 2,5, locking: without, mounting: without, type of packaging: packed in cardboard

UKK 3-MSTB-5,08 AU 32L - Double-level terminal block

2770969

<https://www.phoenixcontact.com/us/products/2770969>

QC 1/ 8-ST-5,08 - PCB connector

1883310

<https://www.phoenixcontact.com/us/products/1883310>

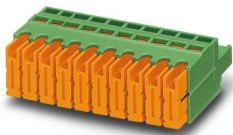

PCB connector, nominal cross section: 1 mm², color: green, nominal current: 10 A, rated voltage (III/2): 630 V, contact surface: Tin, contact connection type: Socket, number of potentials: 8, number of rows: 1, number of positions: 8, number of connections: 8, product range: QC 1/..-ST, pitch: 5.08 mm, connection method: Displacement connection, conductor/PCB connection direction: 0 °, locking clip: - Locking clip, plug-in system: COMBICON MSTB 2,5, locking: without, mounting: without, type of packaging: packed in cardboard

QC 1/12-ST-5,08 - PCB connector

1883705

<https://www.phoenixcontact.com/us/products/1883705>

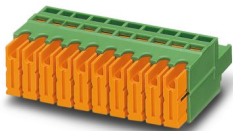

PCB connector, nominal cross section: 1 mm², color: green, nominal current: 10 A, rated voltage (III/2): 630 V, contact surface: Tin, contact connection type: Socket, number of potentials: 12, number of rows: 1, number of positions: 12, number of connections: 12, product range: QC 1/..-ST, pitch: 5.08 mm, connection method: Displacement connection, conductor/PCB connection direction: 0 °, locking clip: - Locking clip, plug-in system: COMBICON MSTB 2,5, locking: without, mounting: without, type of packaging: packed in cardboard

UKK 3-MSTB-5,08 AU 32L - Double-level terminal block



2770969

<https://www.phoenixcontact.com/us/products/2770969>

QC 1/15-ST-5,08 - PCB connector

1883831

<https://www.phoenixcontact.com/us/products/1883831>

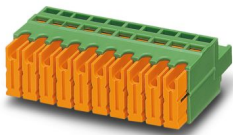

PCB connector, nominal cross section: 1 mm², color: green, nominal current: 10 A, rated voltage (III/2): 630 V, contact surface: Tin, contact connection type: Socket, number of potentials: 15, number of rows: 1, number of positions: 15, number of connections: 15, product range: QC 1/..-ST, pitch: 5.08 mm, connection method: Displacement connection, conductor/PCB connection direction: 0 °, locking clip: - Locking clip, plug-in system: COMBICON MSTB 2,5, locking: without, mounting: without, type of packaging: packed in cardboard

QC 1/16-ST-5,08 - PCB connector

1883844

<https://www.phoenixcontact.com/us/products/1883844>

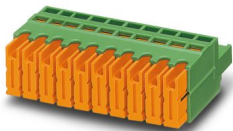

PCB connector, nominal cross section: 1 mm², color: green, nominal current: 10 A, rated voltage (III/2): 630 V, contact surface: Tin, contact connection type: Socket, number of potentials: 16, number of rows: 1, number of positions: 16, number of connections: 16, product range: QC 1/..-ST, pitch: 5.08 mm, connection method: Displacement connection, conductor/PCB connection direction: 0 °, locking clip: - Locking clip, plug-in system: COMBICON MSTB 2,5, locking: without, mounting: without, type of packaging: packed in cardboard

UKK 3-MSTB-5,08 AU 32L - Double-level terminal block



2770969

<https://www.phoenixcontact.com/us/products/2770969>

QC 1/13-ST-5,08 - PCB connector

1883815

<https://www.phoenixcontact.com/us/products/1883815>

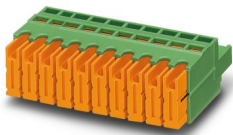

PCB connector, nominal cross section: 1 mm², color: green, nominal current: 10 A, rated voltage (III/2): 630 V, contact surface: Tin, contact connection type: Socket, number of potentials: 13, number of rows: 1, number of positions: 13, number of connections: 13, product range: QC 1/..-ST, pitch: 5.08 mm, connection method: Displacement connection, conductor/PCB connection direction: 0 °, locking clip: - Locking clip, plug-in system: COMBICON MSTB 2,5, locking: without, mounting: without, type of packaging: packed in cardboard

QC 1/10-ST-5,08 - PCB connector

1883336

<https://www.phoenixcontact.com/us/products/1883336>

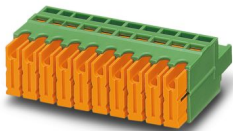

PCB connector, nominal cross section: 1 mm², color: green, nominal current: 10 A, rated voltage (III/2): 630 V, contact surface: Tin, contact connection type: Socket, number of potentials: 10, number of rows: 1, number of positions: 10, number of connections: 10, product range: QC 1/..-ST, pitch: 5.08 mm, connection method: Displacement connection, conductor/PCB connection direction: 0 °, locking clip: - Locking clip, plug-in system: COMBICON MSTB 2,5, locking: without, mounting: without, type of packaging: packed in cardboard

UKK 3-MSTB-5,08 AU 32L - Double-level terminal block



2770969

<https://www.phoenixcontact.com/us/products/2770969>

QC 1/14-ST-5,08 - PCB connector

1883828

<https://www.phoenixcontact.com/us/products/1883828>

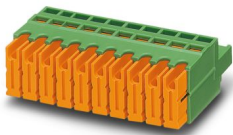

PCB connector, nominal cross section: 1 mm², color: green, nominal current: 10 A, rated voltage (III/2): 630 V, contact surface: Tin, contact connection type: Socket, number of potentials: 14, number of rows: 1, number of positions: 14, number of connections: 14, product range: QC 1/..-ST, pitch: 5.08 mm, connection method: Displacement connection, conductor/PCB connection direction: 0 °, locking clip: - Locking clip, plug-in system: COMBICON MSTB 2,5, locking: without, mounting: without, type of packaging: packed in cardboard

QC 1/ 9-ST-5,08 - PCB connector

1883323

<https://www.phoenixcontact.com/us/products/1883323>

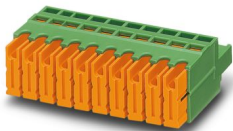

PCB connector, nominal cross section: 1 mm², color: green, nominal current: 10 A, rated voltage (III/2): 630 V, contact surface: Tin, contact connection type: Socket, number of potentials: 9, number of rows: 1, number of positions: 9, number of connections: 9, product range: QC 1/..-ST, pitch: 5.08 mm, connection method: Displacement connection, conductor/PCB connection direction: 0 °, locking clip: - Locking clip, plug-in system: COMBICON MSTB 2,5, locking: without, mounting: without, type of packaging: packed in cardboard

UKK 3-MSTB-5,08 AU 32L - Double-level terminal block

2770969

<https://www.phoenixcontact.com/us/products/2770969>

QC 1/11-ST-5,08 - PCB connector

1883349

<https://www.phoenixcontact.com/us/products/1883349>

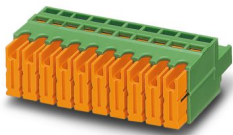

PCB connector, nominal cross section: 1 mm², color: green, nominal current: 10 A, rated voltage (III/2): 630 V, contact surface: Tin, contact connection type: Socket, number of potentials: 11, number of rows: 1, number of positions: 11, number of connections: 11, product range: QC 1/..-ST, pitch: 5.08 mm, connection method: Displacement connection, conductor/PCB connection direction: 0 °, locking clip: - Locking clip, plug-in system: COMBICON MSTB 2,5, locking: without, mounting: without, type of packaging: packed in cardboard

QC 1/ 7-ST-5,08 - PCB connector

1883307

<https://www.phoenixcontact.com/us/products/1883307>

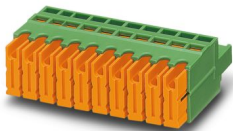

PCB connector, nominal cross section: 1 mm², color: green, nominal current: 10 A, rated voltage (III/2): 630 V, contact surface: Tin, contact connection type: Socket, number of potentials: 7, number of rows: 1, number of positions: 7, number of connections: 7, product range: QC 1/..-ST, pitch: 5.08 mm, connection method: Displacement connection, conductor/PCB connection direction: 0 °, locking clip: - Locking clip, plug-in system: COMBICON MSTB 2,5, locking: without, mounting: without, type of packaging: packed in cardboard

UKK 3-MSTB-5,08 AU 32L - Double-level terminal block

2770969

<https://www.phoenixcontact.com/us/products/2770969>

QC 1/ 4-ST-5,08 - PCB connector

1883271

<https://www.phoenixcontact.com/us/products/1883271>

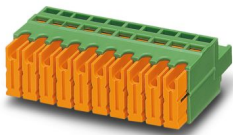

PCB connector, nominal cross section: 1 mm², color: green, nominal current: 10 A, rated voltage (III/2): 630 V, contact surface: Tin, contact connection type: Socket, number of potentials: 4, number of rows: 1, number of positions: 4, number of connections: 4, product range: QC 1/..-ST, pitch: 5.08 mm, connection method: Displacement connection, conductor/PCB connection direction: 0 °, locking clip: - Locking clip, plug-in system: COMBICON MSTB 2,5, locking: without, mounting: without, type of packaging: packed in cardboard

QC 1/ 3-ST-5,08 - PCB connector

1883268

<https://www.phoenixcontact.com/us/products/1883268>

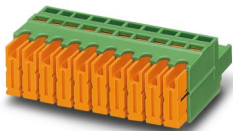

PCB connector, nominal cross section: 1 mm², color: green, nominal current: 10 A, rated voltage (III/2): 630 V, contact surface: Tin, contact connection type: Socket, number of potentials: 3, number of rows: 1, number of positions: 3, number of connections: 3, product range: QC 1/..-ST, pitch: 5.08 mm, connection method: Displacement connection, conductor/PCB connection direction: 0 °, locking clip: - Locking clip, plug-in system: COMBICON MSTB 2,5, locking: without, mounting: without, type of packaging: packed in cardboard

UKK 3-MSTB-5,08 AU 32L - Double-level terminal block



2770969

<https://www.phoenixcontact.com/us/products/2770969>

MSTBC 2,5/ 5-ST-5,08 - PCB connector

1808845

<https://www.phoenixcontact.com/us/products/1808845>



PCB connector, nominal cross section: 2.5 mm², color: green, nominal current: 12 A, rated voltage (III/2): 320 V, contact connection type: Socket, number of potentials: 5, number of rows: 1, number of positions: 5, number of connections: 5, product range: MSTBC 2,5/..-ST, pitch: 5.08 mm, connection method: Crimp connection, conductor/PCB connection direction: 0 °, locking clip: - Locking clip, plug-in system: COMBICON MSTB 2,5, locking: without, mounting: without, type of packaging: packed in cardboard, Corresponding female crimp contacts with current [A] and conductor cross section range [mm²] data: 10A/MSTBC-MT 0,5-1,0 (3190564); 10A/MSTBC-MT 0,5-1,0 BA (3190645); 12A/MSTBC-MT 1,5-2,5 (3190551); 12A/MSTBC-MT 1,5-2,5 BA (3190658). BA = Bandkontakte

MSTBC 2,5/ 6-ST-5,08 - PCB connector

1808858

<https://www.phoenixcontact.com/us/products/1808858>



PCB connector, nominal cross section: 2.5 mm², color: green, nominal current: 12 A, rated voltage (III/2): 320 V, contact connection type: Socket, number of potentials: 6, number of rows: 1, number of positions: 6, number of connections: 6, product range: MSTBC 2,5/..-ST, pitch: 5.08 mm, connection method: Crimp connection, conductor/PCB connection direction: 0 °, locking clip: - Locking clip, plug-in system: COMBICON MSTB 2,5, locking: without, mounting: without, type of packaging: packed in cardboard, Corresponding female crimp contacts with current [A] and conductor cross section range [mm²] data: 10A/MSTBC-MT 0,5-1,0 (3190564); 10A/MSTBC-MT 0,5-1,0 BA (3190645); 12A/MSTBC-MT 1,5-2,5 (3190551); 12A/MSTBC-MT 1,5-2,5 BA (3190658). BA = Bandkontakte

UKK 3-MSTB-5,08 AU 32L - Double-level terminal block

2770969

<https://www.phoenixcontact.com/us/products/2770969>

MSTBC 2,5/ 8-ST-5,08 - PCB connector

1808874

<https://www.phoenixcontact.com/us/products/1808874>



PCB connector, nominal cross section: 2.5 mm², color: green, nominal current: 12 A, rated voltage (III/2): 320 V, contact connection type: Socket, number of potentials: 8, number of rows: 1, number of positions: 8, number of connections: 8, product range: MSTBC 2,5/..-ST, pitch: 5.08 mm, connection method: Crimp connection, conductor/PCB connection direction: 0 °, locking clip: - Locking clip, plug-in system: COMBICON MSTB 2,5, locking: without, mounting: without, type of packaging: packed in cardboard, Corresponding female crimp contacts with current [A] and conductor cross section range [mm²] data: 10A/MSTBC-MT 0,5-1,0 (3190564); 10A/MSTBC-MT 0,5-1,0 BA (3190645); 12A/MSTBC-MT 1,5-2,5 (3190551); 12A/MSTBC-MT 1,5-2,5 BA (3190658). BA = Bandkontakte

MSTBC 2,5/13-ST-5,08 - PCB connector

1808926

<https://www.phoenixcontact.com/us/products/1808926>



PCB connector, nominal cross section: 2.5 mm², color: green, nominal current: 12 A, rated voltage (III/2): 320 V, contact connection type: Socket, number of potentials: 13, number of rows: 1, number of positions: 13, number of connections: 13, product range: MSTBC 2,5/..-ST, pitch: 5.08 mm, connection method: Crimp connection, conductor/PCB connection direction: 0 °, locking clip: - Locking clip, plug-in system: COMBICON MSTB 2,5, locking: without, mounting: without, type of packaging: packed in cardboard, Corresponding female crimp contacts with current [A] and conductor cross section range [mm²] data: 10A/MSTBC-MT 0,5-1,0 (3190564); 10A/MSTBC-MT 0,5-1,0 BA (3190645); 12A/MSTBC-MT 1,5-2,5 (3190551); 12A/MSTBC-MT 1,5-2,5 BA (3190658). BA = Bandkontakte

UKK 3-MSTB-5,08 AU 32L - Double-level terminal block

2770969

<https://www.phoenixcontact.com/us/products/2770969>

MSTBC 2,5/14-ST-5,08 - PCB connector

1808939

<https://www.phoenixcontact.com/us/products/1808939>



PCB connector, nominal cross section: 2.5 mm², color: green, nominal current: 12 A, rated voltage (III/2): 320 V, contact connection type: Socket, number of potentials: 14, number of rows: 1, number of positions: 14, number of connections: 14, product range: MSTBC 2,5/...-ST, pitch: 5.08 mm, connection method: Crimp connection, conductor/PCB connection direction: 0 °, locking clip: - Locking clip, plug-in system: COMBICON MSTB 2,5, locking: without, mounting: without, type of packaging: packed in cardboard, Corresponding female crimp contacts with current [A] and conductor cross section range [mm²] data: 10A/MSTBC-MT 0,5-1,0 (3190564); 10A/MSTBC-MT 0,5-1,0 BA (3190645); 12A/MSTBC-MT 1,5-2,5 (3190551); 12A/MSTBC-MT 1,5-2,5 BA (3190658). BA = Bandkontakte

MSTBC 2,5/15-ST-5,08 - PCB connector

1808942

<https://www.phoenixcontact.com/us/products/1808942>



PCB connector, nominal cross section: 2.5 mm², color: green, nominal current: 12 A, rated voltage (III/2): 320 V, contact connection type: Socket, number of potentials: 15, number of rows: 1, number of positions: 15, number of connections: 15, product range: MSTBC 2,5/...-ST, pitch: 5.08 mm, connection method: Crimp connection, conductor/PCB connection direction: 0 °, locking clip: - Locking clip, plug-in system: COMBICON MSTB 2,5, locking: without, mounting: without, type of packaging: packed in cardboard, Corresponding female crimp contacts with current [A] and conductor cross section range [mm²] data: 10A/MSTBC-MT 0,5-1,0 (3190564); 10A/MSTBC-MT 0,5-1,0 BA (3190645); 12A/MSTBC-MT 1,5-2,5 (3190551); 12A/MSTBC-MT 1,5-2,5 BA (3190658). BA = Bandkontakte

UKK 3-MSTB-5,08 AU 32L - Double-level terminal block

2770969

<https://www.phoenixcontact.com/us/products/2770969>

MSTBC 2,5/19-ST-5,08 - PCB connector

1808984

<https://www.phoenixcontact.com/us/products/1808984>



PCB connector, nominal cross section: 2.5 mm², color: green, nominal current: 12 A, rated voltage (III/2): 320 V, contact connection type: Socket, number of potentials: 19, number of rows: 1, number of positions: 19, number of connections: 19, product range: MSTBC 2,5/...-ST, pitch: 5.08 mm, connection method: Crimp connection, conductor/PCB connection direction: 0 °, locking clip: - Locking clip, plug-in system: COMBICON MSTB 2,5, locking: without, mounting: without, type of packaging: packed in cardboard, Corresponding female crimp contacts with current [A] and conductor cross section range [mm²] data: 10A/MSTBC-MT 0,5-1,0 (3190564); 10A/MSTBC-MT 0,5-1,0 BA (3190645); 12A/MSTBC-MT 1,5-2,5 (3190551); 12A/MSTBC-MT 1,5-2,5 BA (3190658). BA = Bandkontakte

MSTBC 2,5/20-ST-5,08 - PCB connector

1808997

<https://www.phoenixcontact.com/us/products/1808997>



PCB connector, nominal cross section: 2.5 mm², color: green, nominal current: 12 A, rated voltage (III/2): 320 V, contact connection type: Socket, number of potentials: 20, number of rows: 1, number of positions: 20, number of connections: 20, product range: MSTBC 2,5/...-ST, pitch: 5.08 mm, connection method: Crimp connection, conductor/PCB connection direction: 0 °, locking clip: - Locking clip, plug-in system: COMBICON MSTB 2,5, locking: without, mounting: without, type of packaging: packed in cardboard, Corresponding female crimp contacts with current [A] and conductor cross section range [mm²] data: 10A/MSTBC-MT 0,5-1,0 (3190564); 10A/MSTBC-MT 0,5-1,0 BA (3190645); 12A/MSTBC-MT 1,5-2,5 (3190551); 12A/MSTBC-MT 1,5-2,5 BA (3190658). BA = Bandkontakte

UKK 3-MSTB-5,08 AU 32L - Double-level terminal block

2770969

<https://www.phoenixcontact.com/us/products/2770969>

MSTBC 2,5/12-ST-5,08 - PCB connector

1808913

<https://www.phoenixcontact.com/us/products/1808913>



PCB connector, nominal cross section: 2.5 mm², color: green, nominal current: 12 A, rated voltage (III/2): 320 V, contact connection type: Socket, number of potentials: 12, number of rows: 1, number of positions: 12, number of connections: 12, product range: MSTBC 2,5/...-ST, pitch: 5.08 mm, connection method: Crimp connection, conductor/PCB connection direction: 0 °, locking clip: - Locking clip, plug-in system: COMBICON MSTB 2,5, locking: without, mounting: without, type of packaging: packed in cardboard, Corresponding female crimp contacts with current [A] and conductor cross section range [mm²] data: 10A/MSTBC-MT 0,5-1,0 (3190564); 10A/MSTBC-MT 0,5-1,0 BA (3190645); 12A/MSTBC-MT 1,5-2,5 (3190551); 12A/MSTBC-MT 1,5-2,5 BA (3190658). BA = Bandkontakte

MSTBC 2,5/18-ST-5,08 - PCB connector

1808971

<https://www.phoenixcontact.com/us/products/1808971>



PCB connector, nominal cross section: 2.5 mm², color: green, nominal current: 12 A, rated voltage (III/2): 320 V, contact connection type: Socket, number of potentials: 18, number of rows: 1, number of positions: 18, number of connections: 18, product range: MSTBC 2,5/...-ST, pitch: 5.08 mm, connection method: Crimp connection, conductor/PCB connection direction: 0 °, locking clip: - Locking clip, plug-in system: COMBICON MSTB 2,5, locking: without, mounting: without, type of packaging: packed in cardboard, Corresponding female crimp contacts with current [A] and conductor cross section range [mm²] data: 10A/MSTBC-MT 0,5-1,0 (3190564); 10A/MSTBC-MT 0,5-1,0 BA (3190645); 12A/MSTBC-MT 1,5-2,5 (3190551); 12A/MSTBC-MT 1,5-2,5 BA (3190658). BA = Bandkontakte

UKK 3-MSTB-5,08 AU 32L - Double-level terminal block



2770969

<https://www.phoenixcontact.com/us/products/2770969>

MSTBC 2,5/ 3-ST-5,08 - PCB connector

1808829

<https://www.phoenixcontact.com/us/products/1808829>



PCB connector, nominal cross section: 2.5 mm², color: green, nominal current: 12 A, rated voltage (III/2): 320 V, contact connection type: Socket, number of potentials: 3, number of rows: 1, number of positions: 3, number of connections: 3, product range: MSTBC 2,5/..-ST, pitch: 5.08 mm, connection method: Crimp connection, conductor/PCB connection direction: 0 °, locking clip: - Locking clip, plug-in system: COMBICON MSTB 2,5, locking: without, mounting: without, type of packaging: packed in cardboard, Corresponding female crimp contacts with current [A] and conductor cross section range [mm²] data: 10A/MSTBC-MT 0,5-1,0 (3190564); 10A/MSTBC-MT 0,5-1,0 BA (3190645); 12A/MSTBC-MT 1,5-2,5 (3190551); 12A/MSTBC-MT 1,5-2,5 BA (3190658). BA = Bandkontakte

MSTBC 2,5/22-ST-5,08 - PCB connector

1809019

<https://www.phoenixcontact.com/us/products/1809019>



PCB connector, nominal cross section: 2.5 mm², color: green, nominal current: 12 A, rated voltage (III/2): 320 V, contact connection type: Socket, number of potentials: 22, number of rows: 1, number of positions: 22, number of connections: 22, product range: MSTBC 2,5/..-ST, pitch: 5.08 mm, connection method: Crimp connection, conductor/PCB connection direction: 0 °, locking clip: - Locking clip, plug-in system: COMBICON MSTB 2,5, locking: without, mounting: without, type of packaging: packed in cardboard, Corresponding female crimp contacts with current [A] and conductor cross section range [mm²] data: 10A/MSTBC-MT 0,5-1,0 (3190564); 10A/MSTBC-MT 0,5-1,0 BA (3190645); 12A/MSTBC-MT 1,5-2,5 (3190551); 12A/MSTBC-MT 1,5-2,5 BA (3190658). BA = Bandkontakte

UKK 3-MSTB-5,08 AU 32L - Double-level terminal block

2770969

<https://www.phoenixcontact.com/us/products/2770969>

MSTBC 2,5/ 7-ST-5,08 - PCB connector

1808861

<https://www.phoenixcontact.com/us/products/1808861>



PCB connector, nominal cross section: 2.5 mm², color: green, nominal current: 12 A, rated voltage (III/2): 320 V, contact connection type: Socket, number of potentials: 7, number of rows: 1, number of positions: 7, number of connections: 7, product range: MSTBC 2,5/..-ST, pitch: 5.08 mm, connection method: Crimp connection, conductor/PCB connection direction: 0 °, locking clip: - Locking clip, plug-in system: COMBICON MSTB 2,5, locking: without, mounting: without, type of packaging: packed in cardboard, Corresponding female crimp contacts with current [A] and conductor cross section range [mm²] data: 10A/MSTBC-MT 0,5-1,0 (3190564); 10A/MSTBC-MT 0,5-1,0 BA (3190645); 12A/MSTBC-MT 1,5-2,5 (3190551); 12A/MSTBC-MT 1,5-2,5 BA (3190658). BA = Bandkontakte

MSTBC 2,5/ 9-ST-5,08 - PCB connector

1808887

<https://www.phoenixcontact.com/us/products/1808887>



PCB connector, nominal cross section: 2.5 mm², color: green, nominal current: 12 A, rated voltage (III/2): 320 V, contact connection type: Socket, number of potentials: 9, number of rows: 1, number of positions: 9, number of connections: 9, product range: MSTBC 2,5/..-ST, pitch: 5.08 mm, connection method: Crimp connection, conductor/PCB connection direction: 0 °, locking clip: - Locking clip, plug-in system: COMBICON MSTB 2,5, locking: without, mounting: without, type of packaging: packed in cardboard, Corresponding female crimp contacts with current [A] and conductor cross section range [mm²] data: 10A/MSTBC-MT 0,5-1,0 (3190564); 10A/MSTBC-MT 0,5-1,0 BA (3190645); 12A/MSTBC-MT 1,5-2,5 (3190551); 12A/MSTBC-MT 1,5-2,5 BA (3190658). BA = Bandkontakte

UKK 3-MSTB-5,08 AU 32L - Double-level terminal block

2770969

<https://www.phoenixcontact.com/us/products/2770969>

MSTBC 2,5/23-ST-5,08 - PCB connector

1809022

<https://www.phoenixcontact.com/us/products/1809022>



PCB connector, nominal cross section: 2.5 mm², color: green, nominal current: 12 A, rated voltage (III/2): 320 V, contact connection type: Socket, number of potentials: 23, number of rows: 1, number of positions: 23, number of connections: 23, product range: MSTBC 2,5/...-ST, pitch: 5.08 mm, connection method: Crimp connection, conductor/PCB connection direction: 0 °, locking clip: - Locking clip, plug-in system: COMBICON MSTB 2,5, locking: without, mounting: without, type of packaging: packed in cardboard, Corresponding female crimp contacts with current [A] and conductor cross section range [mm²] data: 10A/MSTBC-MT 0,5-1,0 (3190564); 10A/MSTBC-MT 0,5-1,0 BA (3190645); 12A/MSTBC-MT 1,5-2,5 (3190551); 12A/MSTBC-MT 1,5-2,5 BA (3190658). BA = Bandkontakte

MSTBC 2,5/10-ST-5,08 - PCB connector

1808890

<https://www.phoenixcontact.com/us/products/1808890>



PCB connector, nominal cross section: 2.5 mm², color: green, nominal current: 12 A, rated voltage (III/2): 320 V, contact connection type: Socket, number of potentials: 10, number of rows: 1, number of positions: 10, number of connections: 10, product range: MSTBC 2,5/...-ST, pitch: 5.08 mm, connection method: Crimp connection, conductor/PCB connection direction: 0 °, locking clip: - Locking clip, plug-in system: COMBICON MSTB 2,5, locking: without, mounting: without, type of packaging: packed in cardboard, Corresponding female crimp contacts with current [A] and conductor cross section range [mm²] data: 10A/MSTBC-MT 0,5-1,0 (3190564); 10A/MSTBC-MT 0,5-1,0 BA (3190645); 12A/MSTBC-MT 1,5-2,5 (3190551); 12A/MSTBC-MT 1,5-2,5 BA (3190658). BA = Bandkontakte

UKK 3-MSTB-5,08 AU 32L - Double-level terminal block



2770969

<https://www.phoenixcontact.com/us/products/2770969>

MSTBC 2,5/ 2-ST-5,08 - PCB connector

1808816

<https://www.phoenixcontact.com/us/products/1808816>



PCB connector, nominal cross section: 2.5 mm², color: green, nominal current: 12 A, rated voltage (III/2): 320 V, contact connection type: Socket, number of potentials: 2, number of rows: 1, number of positions: 2, number of connections: 2, product range: MSTBC 2,5/..-ST, pitch: 5.08 mm, connection method: Crimp connection, conductor/PCB connection direction: 0 °, locking clip: - Locking clip, plug-in system: COMBICON MSTB 2,5, locking: without, mounting: without, type of packaging: packed in cardboard, Corresponding female crimp contacts with current [A] and conductor cross section range [mm²] data: 10A/MSTBC-MT 0,5-1,0 (3190564); 10A/MSTBC-MT 0,5-1,0 BA (3190645); 12A/MSTBC-MT 1,5-2,5 (3190551); 12A/MSTBC-MT 1,5-2,5 BA (3190658). BA = Bandkontakte

MSTBC 2,5/ 4-ST-5,08 - PCB connector

1808832

<https://www.phoenixcontact.com/us/products/1808832>



PCB connector, nominal cross section: 2.5 mm², color: green, nominal current: 12 A, rated voltage (III/2): 320 V, contact connection type: Socket, number of potentials: 4, number of rows: 1, number of positions: 4, number of connections: 4, product range: MSTBC 2,5/..-ST, pitch: 5.08 mm, connection method: Crimp connection, conductor/PCB connection direction: 0 °, locking clip: - Locking clip, plug-in system: COMBICON MSTB 2,5, locking: without, mounting: without, type of packaging: packed in cardboard, Corresponding female crimp contacts with current [A] and conductor cross section range [mm²] data: 10A/MSTBC-MT 0,5-1,0 (3190564); 10A/MSTBC-MT 0,5-1,0 BA (3190645); 12A/MSTBC-MT 1,5-2,5 (3190551); 12A/MSTBC-MT 1,5-2,5 BA (3190658). BA = Bandkontakte

UKK 3-MSTB-5,08 AU 32L - Double-level terminal block

2770969

<https://www.phoenixcontact.com/us/products/2770969>

MSTBC 2,5/11-ST-5,08 - PCB connector

1808900

<https://www.phoenixcontact.com/us/products/1808900>



PCB connector, nominal cross section: 2.5 mm², color: green, nominal current: 12 A, rated voltage (III/2): 320 V, contact connection type: Socket, number of potentials: 11, number of rows: 1, number of positions: 11, number of connections: 11, product range: MSTBC 2,5/...-ST, pitch: 5.08 mm, connection method: Crimp connection, conductor/PCB connection direction: 0 °, locking clip: - Locking clip, plug-in system: COMBICON MSTB 2,5, locking: without, mounting: without, type of packaging: packed in cardboard, Corresponding female crimp contacts with current [A] and conductor cross section range [mm²] data: 10A/MSTBC-MT 0,5-1,0 (3190564); 10A/MSTBC-MT 0,5-1,0 BA (3190645); 12A/MSTBC-MT 1,5-2,5 (3190551); 12A/MSTBC-MT 1,5-2,5 BA (3190658). BA = Bandkontakte

MSTBC 2,5/16-ST-5,08 - PCB connector

1808955

<https://www.phoenixcontact.com/us/products/1808955>



PCB connector, nominal cross section: 2.5 mm², color: green, nominal current: 12 A, rated voltage (III/2): 320 V, contact connection type: Socket, number of potentials: 16, number of rows: 1, number of positions: 16, number of connections: 16, product range: MSTBC 2,5/...-ST, pitch: 5.08 mm, connection method: Crimp connection, conductor/PCB connection direction: 0 °, locking clip: - Locking clip, plug-in system: COMBICON MSTB 2,5, locking: without, mounting: without, type of packaging: packed in cardboard, Corresponding female crimp contacts with current [A] and conductor cross section range [mm²] data: 10A/MSTBC-MT 0,5-1,0 (3190564); 10A/MSTBC-MT 0,5-1,0 BA (3190645); 12A/MSTBC-MT 1,5-2,5 (3190551); 12A/MSTBC-MT 1,5-2,5 BA (3190658). BA = Bandkontakte

UKK 3-MSTB-5,08 AU 32L - Double-level terminal block

2770969

<https://www.phoenixcontact.com/us/products/2770969>

MSTBC 2,5/17-ST-5,08 - PCB connector

1808968

<https://www.phoenixcontact.com/us/products/1808968>



PCB connector, nominal cross section: 2.5 mm², color: green, nominal current: 12 A, rated voltage (III/2): 320 V, contact connection type: Socket, number of potentials: 17, number of rows: 1, number of positions: 17, number of connections: 17, product range: MSTBC 2,5/...-ST, pitch: 5.08 mm, connection method: Crimp connection, conductor/PCB connection direction: 0 °, locking clip: - Locking clip, plug-in system: COMBICON MSTB 2,5, locking: without, mounting: without, type of packaging: packed in cardboard, Corresponding female crimp contacts with current [A] and conductor cross section range [mm²] data: 10A/MSTBC-MT 0,5-1,0 (3190564); 10A/MSTBC-MT 0,5-1,0 BA (3190645); 12A/MSTBC-MT 1,5-2,5 (3190551); 12A/MSTBC-MT 1,5-2,5 BA (3190658). BA = Bandkontakte

MSTBC 2,5/24-ST-5,08 - PCB connector

1809035

<https://www.phoenixcontact.com/us/products/1809035>



PCB connector, nominal cross section: 2.5 mm², color: green, nominal current: 12 A, rated voltage (III/2): 320 V, contact connection type: Socket, number of potentials: 24, number of rows: 1, number of positions: 24, number of connections: 24, product range: MSTBC 2,5/...-ST, pitch: 5.08 mm, connection method: Crimp connection, conductor/PCB connection direction: 0 °, locking clip: - Locking clip, plug-in system: COMBICON MSTB 2,5, locking: without, mounting: without, type of packaging: packed in cardboard, Corresponding female crimp contacts with current [A] and conductor cross section range [mm²] data: 10A/MSTBC-MT 0,5-1,0 (3190564); 10A/MSTBC-MT 0,5-1,0 BA (3190645); 12A/MSTBC-MT 1,5-2,5 (3190551); 12A/MSTBC-MT 1,5-2,5 BA (3190658). BA = Bandkontakte

UKK 3-MSTB-5,08 AU 32L - Double-level terminal block



2770969

<https://www.phoenixcontact.com/us/products/2770969>

MSTBC 2,5/21-ST-5,08 - PCB connector

1809006

<https://www.phoenixcontact.com/us/products/1809006>



PCB connector, nominal cross section: 2.5 mm², color: green, nominal current: 12 A, rated voltage (III/2): 320 V, contact connection type: Socket, number of potentials: 21, number of rows: 1, number of positions: 21, number of connections: 21, product range: MSTBC 2,5/...-ST, pitch: 5.08 mm, connection method: Crimp connection, conductor/PCB connection direction: 0 °, locking clip: - Locking clip, plug-in system: COMBICON MSTB 2,5, locking: without, mounting: without, type of packaging: packed in cardboard, Corresponding female crimp contacts with current [A] and conductor cross section range [mm²] data: 10A/MSTBC-MT 0,5-1,0 (3190564); 10A/MSTBC-MT 0,5-1,0 BA (3190645); 12A/MSTBC-MT 1,5-2,5 (3190551); 12A/MSTBC-MT 1,5-2,5 BA (3190658). BA = Bandkontakte

MSTBC 2,5/ 2-STZ-5,08 - PCB connector

1809501

<https://www.phoenixcontact.com/us/products/1809501>



PCB connector, nominal cross section: 2.5 mm², color: green, nominal current: 12 A, rated voltage (III/2): 320 V, contact connection type: Socket, number of potentials: 2, number of rows: 1, number of positions: 2, number of connections: 2, product range: MSTBC 2,5/...-STZ, pitch: 5.08 mm, connection method: Crimp connection, conductor/PCB connection direction: 0 °, locking clip: - Locking clip, plug-in system: COMBICON MSTB 2,5, locking: without, mounting: without, type of packaging: packed in cardboard, Corresponding female crimp contacts with current [A] and conductor cross section range [mm²] data: 10A/MSTBC-MT 0,5-1,0 (3190564); 10A/MSTBC-MT 0,5-1,0 BA (3190645); 12A/MSTBC-MT 1,5-2,5 (3190551); 12A/MSTBC-MT 1,5-2,5 BA (3190658). BA = Bandkontakte

UKK 3-MSTB-5,08 AU 32L - Double-level terminal block

2770969

<https://www.phoenixcontact.com/us/products/2770969>

MSTBC 2,5/ 5-STZ-5,08 - PCB connector

1809530

<https://www.phoenixcontact.com/us/products/1809530>



PCB connector, nominal cross section: 2.5 mm², color: green, nominal current: 12 A, rated voltage (III/2): 320 V, contact connection type: Socket, number of potentials: 5, number of rows: 1, number of positions: 5, number of connections: 5, product range: MSTBC 2,5/...-STZ, pitch: 5.08 mm, connection method: Crimp connection, conductor/PCB connection direction: 0 °, locking clip: - Locking clip, plug-in system: COMBICON MSTB 2,5, locking: without, mounting: without, type of packaging: packed in cardboard, Corresponding female crimp contacts with current [A] and conductor cross section range [mm²] data: 10A/MSTBC-MT 0,5-1,0 (3190564); 10A/MSTBC-MT 0,5-1,0 BA (3190645); 12A/MSTBC-MT 1,5-2,5 (3190551); 12A/MSTBC-MT 1,5-2,5 BA (3190658). BA = Bandkontakte

MSTBC 2,5/ 6-STZ-5,08 - PCB connector

1809543

<https://www.phoenixcontact.com/us/products/1809543>



PCB connector, nominal cross section: 2.5 mm², color: green, nominal current: 12 A, rated voltage (III/2): 320 V, contact connection type: Socket, number of potentials: 6, number of rows: 1, number of positions: 6, number of connections: 6, product range: MSTBC 2,5/...-STZ, pitch: 5.08 mm, connection method: Crimp connection, conductor/PCB connection direction: 0 °, locking clip: - Locking clip, plug-in system: COMBICON MSTB 2,5, locking: without, mounting: without, type of packaging: packed in cardboard, Corresponding female crimp contacts with current [A] and conductor cross section range [mm²] data: 10A/MSTBC-MT 0,5-1,0 (3190564); 10A/MSTBC-MT 0,5-1,0 BA (3190645); 12A/MSTBC-MT 1,5-2,5 (3190551); 12A/MSTBC-MT 1,5-2,5 BA (3190658). BA = Bandkontakte

UKK 3-MSTB-5,08 AU 32L - Double-level terminal block



2770969

<https://www.phoenixcontact.com/us/products/2770969>

MSTBC 2,5/ 9-STZ-5,08 - PCB connector

1809572

<https://www.phoenixcontact.com/us/products/1809572>



PCB connector, nominal cross section: 2.5 mm², color: green, nominal current: 12 A, rated voltage (III/2): 320 V, contact connection type: Socket, number of potentials: 9, number of rows: 1, number of positions: 9, number of connections: 9, product range: MSTBC 2,5/...-STZ, pitch: 5.08 mm, connection method: Crimp connection, conductor/PCB connection direction: 0 °, locking clip: - Locking clip, plug-in system: COMBICON MSTB 2,5, locking: without, mounting: without, type of packaging: packed in cardboard, Corresponding female crimp contacts with current [A] and conductor cross section range [mm²] data: 10A/MSTBC-MT 0,5-1,0 (3190564); 10A/MSTBC-MT 0,5-1,0 BA (3190645); 12A/MSTBC-MT 1,5-2,5 (3190551); 12A/MSTBC-MT 1,5-2,5 BA (3190658). BA = Bandkontakte

MSTBC 2,5/13-STZ-5,08 - PCB connector

1809611

<https://www.phoenixcontact.com/us/products/1809611>



PCB connector, nominal cross section: 2.5 mm², color: green, nominal current: 12 A, rated voltage (III/2): 320 V, contact connection type: Socket, number of potentials: 13, number of rows: 1, number of positions: 13, number of connections: 13, product range: MSTBC 2,5/...-STZ, pitch: 5.08 mm, connection method: Crimp connection, conductor/PCB connection direction: 0 °, locking clip: - Locking clip, plug-in system: COMBICON MSTB 2,5, locking: without, mounting: without, type of packaging: packed in cardboard, Corresponding female crimp contacts with current [A] and conductor cross section range [mm²] data: 10A/MSTBC-MT 0,5-1,0 (3190564); 10A/MSTBC-MT 0,5-1,0 BA (3190645); 12A/MSTBC-MT 1,5-2,5 (3190551); 12A/MSTBC-MT 1,5-2,5 BA (3190658). BA = Bandkontakte

UKK 3-MSTB-5,08 AU 32L - Double-level terminal block



2770969

<https://www.phoenixcontact.com/us/products/2770969>

MSTBC 2,5/15-STZ-5,08 - PCB connector

1809637

<https://www.phoenixcontact.com/us/products/1809637>



PCB connector, nominal cross section: 2.5 mm², color: green, nominal current: 12 A, rated voltage (III/2): 320 V, contact connection type: Socket, number of potentials: 15, number of rows: 1, number of positions: 15, number of connections: 15, product range: MSTBC 2,5/...-STZ, pitch: 5.08 mm, connection method: Crimp connection, conductor/PCB connection direction: 0 °, locking clip: - Locking clip, plug-in system: COMBICON MSTB 2,5, locking: without, mounting: without, type of packaging: packed in cardboard, Corresponding female crimp contacts with current [A] and conductor cross section range [mm²] data: 10A/MSTBC-MT 0,5-1,0 (3190564); 10A/MSTBC-MT 0,5-1,0 BA (3190645); 12A/MSTBC-MT 1,5-2,5 (3190551); 12A/MSTBC-MT 1,5-2,5 BA (3190658). BA = Bandkontakte

MSTBC 2,5/16-STZ-5,08 - PCB connector

1809640

<https://www.phoenixcontact.com/us/products/1809640>



PCB connector, nominal cross section: 2.5 mm², color: green, nominal current: 12 A, rated voltage (III/2): 320 V, contact connection type: Socket, number of potentials: 16, number of rows: 1, number of positions: 16, number of connections: 16, product range: MSTBC 2,5/...-STZ, pitch: 5.08 mm, connection method: Crimp connection, conductor/PCB connection direction: 0 °, locking clip: - Locking clip, plug-in system: COMBICON MSTB 2,5, locking: without, mounting: without, type of packaging: packed in cardboard, Corresponding female crimp contacts with current [A] and conductor cross section range [mm²] data: 10A/MSTBC-MT 0,5-1,0 (3190564); 10A/MSTBC-MT 0,5-1,0 BA (3190645); 12A/MSTBC-MT 1,5-2,5 (3190551); 12A/MSTBC-MT 1,5-2,5 BA (3190658). BA = Bandkontakte

UKK 3-MSTB-5,08 AU 32L - Double-level terminal block



2770969

<https://www.phoenixcontact.com/us/products/2770969>

MSTBC 2,5/19-STZ-5,08 - PCB connector

1809679

<https://www.phoenixcontact.com/us/products/1809679>



PCB connector, nominal cross section: 2.5 mm², color: green, nominal current: 12 A, rated voltage (III/2): 320 V, contact connection type: Socket, number of potentials: 19, number of rows: 1, number of positions: 19, number of connections: 19, product range: MSTBC 2,5/...-STZ, pitch: 5.08 mm, connection method: Crimp connection, conductor/PCB connection direction: 0 °, locking clip: - Locking clip, plug-in system: COMBICON MSTB 2,5, locking: without, mounting: without, type of packaging: packed in cardboard, Corresponding female crimp contacts with current [A] and conductor cross section range [mm²] data: 10A/MSTBC-MT 0,5-1,0 (3190564); 10A/MSTBC-MT 0,5-1,0 BA (3190645); 12A/MSTBC-MT 1,5-2,5 (3190551); 12A/MSTBC-MT 1,5-2,5 BA (3190658). BA = Bandkontakte

MSTBC 2,5/21-STZ-5,08 - PCB connector

1809695

<https://www.phoenixcontact.com/us/products/1809695>



PCB connector, nominal cross section: 2.5 mm², color: green, nominal current: 12 A, rated voltage (III/2): 320 V, contact connection type: Socket, number of potentials: 21, number of rows: 1, number of positions: 21, number of connections: 21, product range: MSTBC 2,5/...-STZ, pitch: 5.08 mm, connection method: Crimp connection, conductor/PCB connection direction: 0 °, locking clip: - Locking clip, plug-in system: COMBICON MSTB 2,5, locking: without, mounting: without, type of packaging: packed in cardboard, Corresponding female crimp contacts with current [A] and conductor cross section range [mm²] data: 10A/MSTBC-MT 0,5-1,0 (3190564); 10A/MSTBC-MT 0,5-1,0 BA (3190645); 12A/MSTBC-MT 1,5-2,5 (3190551); 12A/MSTBC-MT 1,5-2,5 BA (3190658). BA = Bandkontakte

UKK 3-MSTB-5,08 AU 32L - Double-level terminal block



2770969

<https://www.phoenixcontact.com/us/products/2770969>

MSTBC 2,5/22-STZ-5,08 - PCB connector

1809705

<https://www.phoenixcontact.com/us/products/1809705>



PCB connector, nominal cross section: 2.5 mm², color: green, nominal current: 12 A, rated voltage (III/2): 320 V, contact connection type: Socket, number of potentials: 22, number of rows: 1, number of positions: 22, number of connections: 22, product range: MSTBC 2,5/...-STZ, pitch: 5.08 mm, connection method: Crimp connection, conductor/PCB connection direction: 0 °, locking clip: - Locking clip, plug-in system: COMBICON MSTB 2,5, locking: without, mounting: without, type of packaging: packed in cardboard, Corresponding female crimp contacts with current [A] and conductor cross section range [mm²] data: 10A/MSTBC-MT 0,5-1,0 (3190564); 10A/MSTBC-MT 0,5-1,0 BA (3190645); 12A/MSTBC-MT 1,5-2,5 (3190551); 12A/MSTBC-MT 1,5-2,5 BA (3190658). BA = Bandkontakte

MSTBC 2,5/24-STZ-5,08 - PCB connector

1809721

<https://www.phoenixcontact.com/us/products/1809721>



PCB connector, nominal cross section: 2.5 mm², color: green, nominal current: 12 A, rated voltage (III/2): 320 V, contact connection type: Socket, number of potentials: 24, number of rows: 1, number of positions: 24, number of connections: 24, product range: MSTBC 2,5/...-STZ, pitch: 5.08 mm, connection method: Crimp connection, conductor/PCB connection direction: 0 °, locking clip: - Locking clip, plug-in system: COMBICON MSTB 2,5, locking: without, mounting: without, type of packaging: packed in cardboard, Corresponding female crimp contacts with current [A] and conductor cross section range [mm²] data: 10A/MSTBC-MT 0,5-1,0 (3190564); 10A/MSTBC-MT 0,5-1,0 BA (3190645); 12A/MSTBC-MT 1,5-2,5 (3190551); 12A/MSTBC-MT 1,5-2,5 BA (3190658). BA = Bandkontakte

UKK 3-MSTB-5,08 AU 32L - Double-level terminal block

2770969

<https://www.phoenixcontact.com/us/products/2770969>

MSTBC 2,5/14-STZ-5,08 - PCB connector

1809624

<https://www.phoenixcontact.com/us/products/1809624>



PCB connector, nominal cross section: 2.5 mm², color: green, nominal current: 12 A, rated voltage (III/2): 320 V, contact connection type: Socket, number of potentials: 14, number of rows: 1, number of positions: 14, number of connections: 14, product range: MSTBC 2,5/...-STZ, pitch: 5.08 mm, connection method: Crimp connection, conductor/PCB connection direction: 0 °, locking clip: - Locking clip, plug-in system: COMBICON MSTB 2,5, locking: without, mounting: without, type of packaging: packed in cardboard, Corresponding female crimp contacts with current [A] and conductor cross section range [mm²] data: 10A/MSTBC-MT 0,5-1,0 (3190564); 10A/MSTBC-MT 0,5-1,0 BA (3190645); 12A/MSTBC-MT 1,5-2,5 (3190551); 12A/MSTBC-MT 1,5-2,5 BA (3190658). BA = Bandkontakte

MSTBC 2,5/20-STZ-5,08 - PCB connector

1809682

<https://www.phoenixcontact.com/us/products/1809682>



PCB connector, nominal cross section: 2.5 mm², color: green, nominal current: 12 A, rated voltage (III/2): 320 V, contact connection type: Socket, number of potentials: 20, number of rows: 1, number of positions: 20, number of connections: 20, product range: MSTBC 2,5/...-STZ, pitch: 5.08 mm, connection method: Crimp connection, conductor/PCB connection direction: 0 °, locking clip: - Locking clip, plug-in system: COMBICON MSTB 2,5, locking: without, mounting: without, type of packaging: packed in cardboard, Corresponding female crimp contacts with current [A] and conductor cross section range [mm²] data: 10A/MSTBC-MT 0,5-1,0 (3190564); 10A/MSTBC-MT 0,5-1,0 BA (3190645); 12A/MSTBC-MT 1,5-2,5 (3190551); 12A/MSTBC-MT 1,5-2,5 BA (3190658). BA = Bandkontakte

UKK 3-MSTB-5,08 AU 32L - Double-level terminal block

2770969

<https://www.phoenixcontact.com/us/products/2770969>

MSTBC 2,5/12-STZ-5,08 - PCB connector

1809608

<https://www.phoenixcontact.com/us/products/1809608>



PCB connector, nominal cross section: 2.5 mm², color: green, nominal current: 12 A, rated voltage (III/2): 320 V, contact connection type: Socket, number of potentials: 12, number of rows: 1, number of positions: 12, number of connections: 12, product range: MSTBC 2,5/...-STZ, pitch: 5.08 mm, connection method: Crimp connection, conductor/PCB connection direction: 0 °, locking clip: - Locking clip, plug-in system: COMBICON MSTB 2,5, locking: without, mounting: without, type of packaging: packed in cardboard, Corresponding female crimp contacts with current [A] and conductor cross section range [mm²] data: 10A/MSTBC-MT 0,5-1,0 (3190564); 10A/MSTBC-MT 0,5-1,0 BA (3190645); 12A/MSTBC-MT 1,5-2,5 (3190551); 12A/MSTBC-MT 1,5-2,5 BA (3190658). BA = Bandkontakte

MSTBC 2,5/17-STZ-5,08 - PCB connector

1809653

<https://www.phoenixcontact.com/us/products/1809653>



PCB connector, nominal cross section: 2.5 mm², color: green, nominal current: 12 A, rated voltage (III/2): 320 V, contact connection type: Socket, number of potentials: 17, number of rows: 1, number of positions: 17, number of connections: 17, product range: MSTBC 2,5/...-STZ, pitch: 5.08 mm, connection method: Crimp connection, conductor/PCB connection direction: 0 °, locking clip: - Locking clip, plug-in system: COMBICON MSTB 2,5, locking: without, mounting: without, type of packaging: packed in cardboard, Corresponding female crimp contacts with current [A] and conductor cross section range [mm²] data: 10A/MSTBC-MT 0,5-1,0 (3190564); 10A/MSTBC-MT 0,5-1,0 BA (3190645); 12A/MSTBC-MT 1,5-2,5 (3190551); 12A/MSTBC-MT 1,5-2,5 BA (3190658). BA = Bandkontakte

UKK 3-MSTB-5,08 AU 32L - Double-level terminal block

2770969

<https://www.phoenixcontact.com/us/products/2770969>

MSTBC 2,5/10-STZ-5,08 - PCB connector

1809585

<https://www.phoenixcontact.com/us/products/1809585>



PCB connector, nominal cross section: 2.5 mm², color: green, nominal current: 12 A, rated voltage (III/2): 320 V, contact connection type: Socket, number of potentials: 10, number of rows: 1, number of positions: 10, number of connections: 10, product range: MSTBC 2,5/...-STZ, pitch: 5.08 mm, connection method: Crimp connection, conductor/PCB connection direction: 0 °, locking clip: - Locking clip, plug-in system: COMBICON MSTB 2,5, locking: without, mounting: without, type of packaging: packed in cardboard, Corresponding female crimp contacts with current [A] and conductor cross section range [mm²] data: 10A/MSTBC-MT 0,5-1,0 (3190564); 10A/MSTBC-MT 0,5-1,0 BA (3190645); 12A/MSTBC-MT 1,5-2,5 (3190551); 12A/MSTBC-MT 1,5-2,5 BA (3190658). BA = Bandkontakte

MSTBC 2,5/ 4-STZ-5,08 - PCB connector

1809527

<https://www.phoenixcontact.com/us/products/1809527>



PCB connector, nominal cross section: 2.5 mm², color: green, nominal current: 12 A, rated voltage (III/2): 320 V, contact connection type: Socket, number of potentials: 4, number of rows: 1, number of positions: 4, number of connections: 4, product range: MSTBC 2,5/...-STZ, pitch: 5.08 mm, connection method: Crimp connection, conductor/PCB connection direction: 0 °, locking clip: - Locking clip, plug-in system: COMBICON MSTB 2,5, locking: without, mounting: without, type of packaging: packed in cardboard, Corresponding female crimp contacts with current [A] and conductor cross section range [mm²] data: 10A/MSTBC-MT 0,5-1,0 (3190564); 10A/MSTBC-MT 0,5-1,0 BA (3190645); 12A/MSTBC-MT 1,5-2,5 (3190551); 12A/MSTBC-MT 1,5-2,5 BA (3190658). BA = Bandkontakte

UKK 3-MSTB-5,08 AU 32L - Double-level terminal block

2770969

<https://www.phoenixcontact.com/us/products/2770969>

MSTBC 2,5/23-STZ-5,08 - PCB connector

1809718

<https://www.phoenixcontact.com/us/products/1809718>



PCB connector, nominal cross section: 2.5 mm², color: green, nominal current: 12 A, rated voltage (III/2): 320 V, contact connection type: Socket, number of potentials: 23, number of rows: 1, number of positions: 23, number of connections: 23, product range: MSTBC 2,5/...-STZ, pitch: 5.08 mm, connection method: Crimp connection, conductor/PCB connection direction: 0 °, locking clip: - Locking clip, plug-in system: COMBICON MSTB 2,5, locking: without, mounting: without, type of packaging: packed in cardboard, Corresponding female crimp contacts with current [A] and conductor cross section range [mm²] data: 10A/MSTBC-MT 0,5-1,0 (3190564); 10A/MSTBC-MT 0,5-1,0 BA (3190645); 12A/MSTBC-MT 1,5-2,5 (3190551); 12A/MSTBC-MT 1,5-2,5 BA (3190658). BA = Bandkontakte

MSTBC 2,5/ 3-STZ-5,08 - PCB connector

1809514

<https://www.phoenixcontact.com/us/products/1809514>



PCB connector, nominal cross section: 2.5 mm², color: green, nominal current: 12 A, rated voltage (III/2): 320 V, contact connection type: Socket, number of potentials: 3, number of rows: 1, number of positions: 3, number of connections: 3, product range: MSTBC 2,5/...-STZ, pitch: 5.08 mm, connection method: Crimp connection, conductor/PCB connection direction: 0 °, locking clip: - Locking clip, plug-in system: COMBICON MSTB 2,5, locking: without, mounting: without, type of packaging: packed in cardboard, Corresponding female crimp contacts with current [A] and conductor cross section range [mm²] data: 10A/MSTBC-MT 0,5-1,0 (3190564); 10A/MSTBC-MT 0,5-1,0 BA (3190645); 12A/MSTBC-MT 1,5-2,5 (3190551); 12A/MSTBC-MT 1,5-2,5 BA (3190658). BA = Bandkontakte

UKK 3-MSTB-5,08 AU 32L - Double-level terminal block



2770969

<https://www.phoenixcontact.com/us/products/2770969>

MSTBC 2,5/ 7-STZ-5,08 - PCB connector

1809556

<https://www.phoenixcontact.com/us/products/1809556>



PCB connector, nominal cross section: 2.5 mm², color: green, nominal current: 12 A, rated voltage (III/2): 320 V, contact connection type: Socket, number of potentials: 7, number of rows: 1, number of positions: 7, number of connections: 7, product range: MSTBC 2,5/..-STZ, pitch: 5.08 mm, connection method: Crimp connection, conductor/PCB connection direction: 0 °, locking clip: - Locking clip, plug-in system: COMBICON MSTB 2,5, locking: without, mounting: without, type of packaging: packed in cardboard, Corresponding female crimp contacts with current [A] and conductor cross section range [mm²] data: 10A/MSTBC-MT 0,5-1,0 (3190564); 10A/MSTBC-MT 0,5-1,0 BA (3190645); 12A/MSTBC-MT 1,5-2,5 (3190551); 12A/MSTBC-MT 1,5-2,5 BA (3190658). BA = Bandkontakte

MSTBC 2,5/ 8-STZ-5,08 - PCB connector

1809569

<https://www.phoenixcontact.com/us/products/1809569>



PCB connector, nominal cross section: 2.5 mm², color: green, nominal current: 12 A, rated voltage (III/2): 320 V, contact connection type: Socket, number of potentials: 8, number of rows: 1, number of positions: 8, number of connections: 8, product range: MSTBC 2,5/..-STZ, pitch: 5.08 mm, connection method: Crimp connection, conductor/PCB connection direction: 0 °, locking clip: - Locking clip, plug-in system: COMBICON MSTB 2,5, locking: without, mounting: without, type of packaging: packed in cardboard, Corresponding female crimp contacts with current [A] and conductor cross section range [mm²] data: 10A/MSTBC-MT 0,5-1,0 (3190564); 10A/MSTBC-MT 0,5-1,0 BA (3190645); 12A/MSTBC-MT 1,5-2,5 (3190551); 12A/MSTBC-MT 1,5-2,5 BA (3190658). BA = Bandkontakte

UKK 3-MSTB-5,08 AU 32L - Double-level terminal block

2770969

<https://www.phoenixcontact.com/us/products/2770969>

MSTBC 2,5/11-STZ-5,08 - PCB connector

1809598

<https://www.phoenixcontact.com/us/products/1809598>



PCB connector, nominal cross section: 2.5 mm², color: green, nominal current: 12 A, rated voltage (III/2): 320 V, contact connection type: Socket, number of potentials: 11, number of rows: 1, number of positions: 11, number of connections: 11, product range: MSTBC 2,5/...-STZ, pitch: 5.08 mm, connection method: Crimp connection, conductor/PCB connection direction: 0 °, locking clip: - Locking clip, plug-in system: COMBICON MSTB 2,5, locking: without, mounting: without, type of packaging: packed in cardboard, Corresponding female crimp contacts with current [A] and conductor cross section range [mm²] data: 10A/MSTBC-MT 0,5-1,0 (3190564); 10A/MSTBC-MT 0,5-1,0 BA (3190645); 12A/MSTBC-MT 1,5-2,5 (3190551); 12A/MSTBC-MT 1,5-2,5 BA (3190658). BA = Bandkontakte

MSTBC 2,5/18-STZ-5,08 - PCB connector

1809666

<https://www.phoenixcontact.com/us/products/1809666>



PCB connector, nominal cross section: 2.5 mm², color: green, nominal current: 12 A, rated voltage (III/2): 320 V, contact connection type: Socket, number of potentials: 18, number of rows: 1, number of positions: 18, number of connections: 18, product range: MSTBC 2,5/...-STZ, pitch: 5.08 mm, connection method: Crimp connection, conductor/PCB connection direction: 0 °, locking clip: - Locking clip, plug-in system: COMBICON MSTB 2,5, locking: without, mounting: without, type of packaging: packed in cardboard, Corresponding female crimp contacts with current [A] and conductor cross section range [mm²] data: 10A/MSTBC-MT 0,5-1,0 (3190564); 10A/MSTBC-MT 0,5-1,0 BA (3190645); 12A/MSTBC-MT 1,5-2,5 (3190551); 12A/MSTBC-MT 1,5-2,5 BA (3190658). BA = Bandkontakte

UKK 3-MSTB-5,08 AU 32L - Double-level terminal block



2770969

<https://www.phoenixcontact.com/us/products/2770969>

MSTB 2,5/ 3-STF-5,08 - PCB connector

1777992

<https://www.phoenixcontact.com/us/products/1777992>

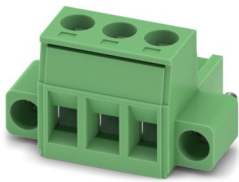

PCB connector, nominal cross section: 2.5 mm², color: green, nominal current: 12 A, rated voltage (III/2): 320 V, contact surface: Tin, contact connection type: Socket, number of potentials: 3, number of rows: 1, number of positions: 3, number of connections: 3, product range: MSTB 2,5/...-STF, pitch: 5.08 mm, connection method: Screw connection with tension sleeve, screw head form: L Slotted, conductor/PCB connection direction: 0 °, locking clip: - without locking clip, plug-in system: COMBICON MSTB 2,5, locking: Screw locking mechanism, mounting: Screw flange, type of packaging: packed in cardboard

MSTB 2,5/ 6-STF-5,08 - PCB connector

1778027

<https://www.phoenixcontact.com/us/products/1778027>



PCB connector, nominal cross section: 2.5 mm², color: green, nominal current: 12 A, rated voltage (III/2): 320 V, contact surface: Tin, contact connection type: Socket, number of potentials: 6, number of rows: 1, number of positions: 6, number of connections: 6, product range: MSTB 2,5/...-STF, pitch: 5.08 mm, connection method: Screw connection with tension sleeve, screw head form: L Slotted, conductor/PCB connection direction: 0 °, locking clip: - without locking clip, plug-in system: COMBICON MSTB 2,5, locking: Screw locking mechanism, mounting: Screw flange, type of packaging: packed in cardboard

UKK 3-MSTB-5,08 AU 32L - Double-level terminal block

2770969

<https://www.phoenixcontact.com/us/products/2770969>

MSTB 2,5/ 8-STF-5,08 - PCB connector

1778043

<https://www.phoenixcontact.com/us/products/1778043>



PCB connector, nominal cross section: 2.5 mm², color: green, nominal current: 12 A, rated voltage (III/2): 320 V, contact surface: Tin, contact connection type: Socket, number of potentials: 8, number of rows: 1, number of positions: 8, number of connections: 8, product range: MSTB 2,5/...-STF, pitch: 5.08 mm, connection method: Screw connection with tension sleeve, screw head form: L Slotted, conductor/PCB connection direction: 0 °, locking clip: - without locking clip, plug-in system: COMBICON MSTB 2,5, locking: Screw locking mechanism, mounting: Screw flange, type of packaging: packed in cardboard

MSTB 2,5/15-STF-5,08 - PCB connector

1778111

<https://www.phoenixcontact.com/us/products/1778111>



PCB connector, nominal cross section: 2.5 mm², color: green, nominal current: 12 A, rated voltage (III/2): 320 V, contact surface: Tin, contact connection type: Socket, number of potentials: 15, number of rows: 1, number of positions: 15, number of connections: 15, product range: MSTB 2,5/...-STF, pitch: 5.08 mm, connection method: Screw connection with tension sleeve, screw head form: L Slotted, conductor/PCB connection direction: 0 °, locking clip: - without locking clip, plug-in system: COMBICON MSTB 2,5, locking: Screw locking mechanism, mounting: Screw flange, type of packaging: packed in cardboard

UKK 3-MSTB-5,08 AU 32L - Double-level terminal block



2770969

<https://www.phoenixcontact.com/us/products/2770969>

MSTB 2,5/16-STF-5,08 - PCB connector

1778124

<https://www.phoenixcontact.com/us/products/1778124>

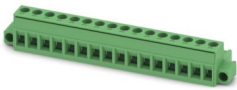

PCB connector, nominal cross section: 2.5 mm², color: green, nominal current: 12 A, rated voltage (III/2): 320 V, contact surface: Tin, contact connection type: Socket, number of potentials: 16, number of rows: 1, number of positions: 16, number of connections: 16, product range: MSTB 2,5/...-STF, pitch: 5.08 mm, connection method: Screw connection with tension sleeve, screw head form: L Slotted, conductor/PCB connection direction: 0 °, locking clip: - without locking clip, plug-in system: COMBICON MSTB 2,5, locking: Screw locking mechanism, mounting: Screw flange, type of packaging: packed in cardboard

MSTB 2,5/17-STF-5,08 - PCB connector

1778137

<https://www.phoenixcontact.com/us/products/1778137>



PCB connector, nominal cross section: 2.5 mm², color: green, nominal current: 12 A, rated voltage (III/2): 320 V, contact surface: Tin, contact connection type: Socket, number of potentials: 17, number of rows: 1, number of positions: 17, number of connections: 17, product range: MSTB 2,5/...-STF, pitch: 5.08 mm, connection method: Screw connection with tension sleeve, screw head form: L Slotted, conductor/PCB connection direction: 0 °, locking clip: - without locking clip, plug-in system: COMBICON MSTB 2,5, locking: Screw locking mechanism, mounting: Screw flange, type of packaging: packed in cardboard

UKK 3-MSTB-5,08 AU 32L - Double-level terminal block



2770969

<https://www.phoenixcontact.com/us/products/2770969>

MSTB 2,5/12-STF-5,08 - PCB connector

1778085

<https://www.phoenixcontact.com/us/products/1778085>

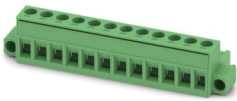

PCB connector, nominal cross section: 2.5 mm², color: green, nominal current: 12 A, rated voltage (III/2): 320 V, contact surface: Tin, contact connection type: Socket, number of potentials: 12, number of rows: 1, number of positions: 12, number of connections: 12, product range: MSTB 2,5/...-STF, pitch: 5.08 mm, connection method: Screw connection with tension sleeve, screw head form: L Slotted, conductor/PCB connection direction: 0 °, locking clip: - without locking clip, plug-in system: COMBICON MSTB 2,5, locking: Screw locking mechanism, mounting: Screw flange, type of packaging: packed in cardboard

MSTB 2,5/ 5-STF-5,08 - PCB connector

1778014

<https://www.phoenixcontact.com/us/products/1778014>



PCB connector, nominal cross section: 2.5 mm², color: green, nominal current: 12 A, rated voltage (III/2): 320 V, contact surface: Tin, contact connection type: Socket, number of potentials: 5, number of rows: 1, number of positions: 5, number of connections: 5, product range: MSTB 2,5/...-STF, pitch: 5.08 mm, connection method: Screw connection with tension sleeve, screw head form: L Slotted, conductor/PCB connection direction: 0 °, locking clip: - without locking clip, plug-in system: COMBICON MSTB 2,5, locking: Screw locking mechanism, mounting: Screw flange, type of packaging: packed in cardboard

UKK 3-MSTB-5,08 AU 32L - Double-level terminal block



2770969

<https://www.phoenixcontact.com/us/products/2770969>

MSTB 2,5/ 9-STF-5,08 - PCB connector

1778056

<https://www.phoenixcontact.com/us/products/1778056>

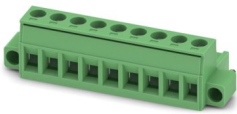

PCB connector, nominal cross section: 2.5 mm², color: green, nominal current: 12 A, rated voltage (III/2): 320 V, contact surface: Tin, contact connection type: Socket, number of potentials: 9, number of rows: 1, number of positions: 9, number of connections: 9, product range: MSTB 2,5/...-STF, pitch: 5.08 mm, connection method: Screw connection with tension sleeve, screw head form: L Slotted, conductor/PCB connection direction: 0 °, locking clip: - without locking clip, plug-in system: COMBICON MSTB 2,5, locking: Screw locking mechanism, mounting: Screw flange, type of packaging: packed in cardboard

MSTB 2,5/14-STF-5,08 - PCB connector

1778108

<https://www.phoenixcontact.com/us/products/1778108>



PCB connector, nominal cross section: 2.5 mm², color: green, nominal current: 12 A, rated voltage (III/2): 320 V, contact surface: Tin, contact connection type: Socket, number of potentials: 14, number of rows: 1, number of positions: 14, number of connections: 14, product range: MSTB 2,5/...-STF, pitch: 5.08 mm, connection method: Screw connection with tension sleeve, screw head form: L Slotted, conductor/PCB connection direction: 0 °, locking clip: - without locking clip, plug-in system: COMBICON MSTB 2,5, locking: Screw locking mechanism, mounting: Screw flange, type of packaging: packed in cardboard

UKK 3-MSTB-5,08 AU 32L - Double-level terminal block

2770969

<https://www.phoenixcontact.com/us/products/2770969>

MSTB 2,5/ 2-STF-5,08 - PCB connector

1777989

<https://www.phoenixcontact.com/us/products/1777989>



PCB connector, nominal cross section: 2.5 mm², color: green, nominal current: 12 A, rated voltage (III/2): 320 V, contact surface: Tin, contact connection type: Socket, number of potentials: 2, number of rows: 1, number of positions: 2, number of connections: 2, product range: MSTB 2,5/...-STF, pitch: 5.08 mm, connection method: Screw connection with tension sleeve, screw head form: L Slotted, conductor/PCB connection direction: 0 °, locking clip: - without locking clip, plug-in system: COMBICON MSTB 2,5, locking: Screw locking mechanism, mounting: Screw flange, type of packaging: packed in cardboard

MSTB 2,5/18-STF-5,08 - PCB connector

1778140

<https://www.phoenixcontact.com/us/products/1778140>



PCB connector, nominal cross section: 2.5 mm², color: green, nominal current: 12 A, rated voltage (III/2): 320 V, contact surface: Tin, contact connection type: Socket, number of potentials: 18, number of rows: 1, number of positions: 18, number of connections: 18, product range: MSTB 2,5/...-STF, pitch: 5.08 mm, connection method: Screw connection with tension sleeve, screw head form: L Slotted, conductor/PCB connection direction: 0 °, locking clip: - without locking clip, plug-in system: COMBICON MSTB 2,5, locking: Screw locking mechanism, mounting: Screw flange, type of packaging: packed in cardboard

UKK 3-MSTB-5,08 AU 32L - Double-level terminal block



2770969

<https://www.phoenixcontact.com/us/products/2770969>

MSTB 2,5/11-STF-5,08 - PCB connector

1778072

<https://www.phoenixcontact.com/us/products/1778072>

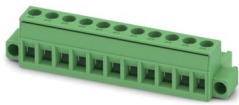

PCB connector, nominal cross section: 2.5 mm², color: green, nominal current: 12 A, rated voltage (III/2): 320 V, contact surface: Tin, contact connection type: Socket, number of potentials: 11, number of rows: 1, number of positions: 11, number of connections: 11, product range: MSTB 2,5/...-STF, pitch: 5.08 mm, connection method: Screw connection with tension sleeve, screw head form: L Slotted, conductor/PCB connection direction: 0 °, locking clip: - without locking clip, plug-in system: COMBICON MSTB 2,5, locking: Screw locking mechanism, mounting: Screw flange, type of packaging: packed in cardboard

MSTB 2,5/ 4-STF-5,08 - PCB connector

1778001

<https://www.phoenixcontact.com/us/products/1778001>



PCB connector, nominal cross section: 2.5 mm², color: green, nominal current: 12 A, rated voltage (III/2): 320 V, contact surface: Tin, contact connection type: Socket, number of potentials: 4, number of rows: 1, number of positions: 4, number of connections: 4, product range: MSTB 2,5/...-STF, pitch: 5.08 mm, connection method: Screw connection with tension sleeve, screw head form: L Slotted, conductor/PCB connection direction: 0 °, locking clip: - without locking clip, plug-in system: COMBICON MSTB 2,5, locking: Screw locking mechanism, mounting: Screw flange, type of packaging: packed in cardboard

UKK 3-MSTB-5,08 AU 32L - Double-level terminal block



2770969

<https://www.phoenixcontact.com/us/products/2770969>

MSTB 2,5/ 7-STF-5,08 - PCB connector

1778030

<https://www.phoenixcontact.com/us/products/1778030>

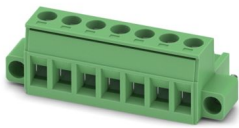

PCB connector, nominal cross section: 2.5 mm², color: green, nominal current: 12 A, rated voltage (III/2): 320 V, contact surface: Tin, contact connection type: Socket, number of potentials: 7, number of rows: 1, number of positions: 7, number of connections: 7, product range: MSTB 2,5/...-STF, pitch: 5.08 mm, connection method: Screw connection with tension sleeve, screw head form: L Slotted, conductor/PCB connection direction: 0 °, locking clip: - Locking clip, plug-in system: COMBICON MSTB 2,5, locking: without, mounting: without, type of packaging: packed in cardboard

MSTB 2,5/10-STF-5,08 - PCB connector

1778069

<https://www.phoenixcontact.com/us/products/1778069>



PCB connector, nominal cross section: 2.5 mm², color: green, nominal current: 12 A, rated voltage (III/2): 320 V, contact surface: Tin, contact connection type: Socket, number of potentials: 10, number of rows: 1, number of positions: 10, number of connections: 10, product range: MSTB 2,5/...-STF, pitch: 5.08 mm, connection method: Screw connection with tension sleeve, screw head form: L Slotted, conductor/PCB connection direction: 0 °, locking clip: - without locking clip, plug-in system: COMBICON MSTB 2,5, locking: Screw locking mechanism, mounting: Screw flange, type of packaging: packed in cardboard

UKK 3-MSTB-5,08 AU 32L - Double-level terminal block



2770969

<https://www.phoenixcontact.com/us/products/2770969>

MSTB 2,5/13-STF-5,08 - PCB connector

1778098

<https://www.phoenixcontact.com/us/products/1778098>

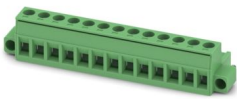

PCB connector, nominal cross section: 2.5 mm², color: green, nominal current: 12 A, rated voltage (III/2): 320 V, contact surface: Tin, contact connection type: Socket, number of potentials: 13, number of rows: 1, number of positions: 13, number of connections: 13, product range: MSTB 2,5/...-STF, pitch: 5.08 mm, connection method: Screw connection with tension sleeve, screw head form: L Slotted, conductor/PCB connection direction: 0 °, locking clip: - without locking clip, plug-in system: COMBICON MSTB 2,5, locking: Screw locking mechanism, mounting: Screw flange, type of packaging: packed in cardboard

MSTB 2,5/19-STF-5,08 - PCB connector

1778153

<https://www.phoenixcontact.com/us/products/1778153>



PCB connector, nominal cross section: 2.5 mm², color: green, nominal current: 12 A, rated voltage (III/2): 320 V, contact surface: Tin, contact connection type: Socket, number of potentials: 19, number of rows: 1, number of positions: 19, number of connections: 19, product range: MSTB 2,5/...-STF, pitch: 5.08 mm, connection method: Screw connection with tension sleeve, screw head form: L Slotted, conductor/PCB connection direction: 0 °, locking clip: - without locking clip, plug-in system: COMBICON MSTB 2,5, locking: Screw locking mechanism, mounting: Screw flange, type of packaging: packed in cardboard

UKK 3-MSTB-5,08 AU 32L - Double-level terminal block



2770969

<https://www.phoenixcontact.com/us/products/2770969>

MSTB 2,5/20-STF-5,08 - PCB connector

1778166

<https://www.phoenixcontact.com/us/products/1778166>

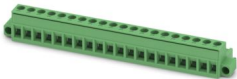

PCB connector, nominal cross section: 2.5 mm², color: green, nominal current: 12 A, rated voltage (III/2): 320 V, contact surface: Tin, contact connection type: Socket, number of potentials: 20, number of rows: 1, number of positions: 20, number of connections: 20, product range: MSTB 2,5/...-STF, pitch: 5.08 mm, connection method: Screw connection with tension sleeve, screw head form: L Slotted, conductor/PCB connection direction: 0 °, locking clip: - without locking clip, plug-in system: COMBICON MSTB 2,5, locking: Screw locking mechanism, mounting: Screw flange, type of packaging: packed in cardboard

MSTBT 2,5/ 2-STF-5,08 - PCB connector

1805301

<https://www.phoenixcontact.com/us/products/1805301>

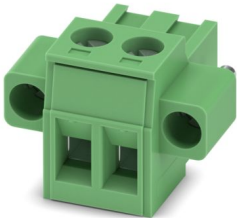

PCB connector, nominal cross section: 2.5 mm², color: green, nominal current: 12 A, rated voltage (III/2): 320 V, contact surface: Tin, contact connection type: Socket, number of potentials: 2, number of rows: 1, number of positions: 2, number of connections: 2, product range: MSTBT 2,5/...-STF, pitch: 5.08 mm, connection method: Screw connection with tension sleeve, screw head form: L Slotted, conductor/PCB connection direction: 0 °, locking clip: - without locking clip, plug-in system: COMBICON MSTB 2,5, locking: Screw locking mechanism, mounting: Screw flange, type of packaging: packed in cardboard

UKK 3-MSTB-5,08 AU 32L - Double-level terminal block



2770969

<https://www.phoenixcontact.com/us/products/2770969>

MSTBT 2,5/12-STF-5,08 - PCB connector

1805398

<https://www.phoenixcontact.com/us/products/1805398>

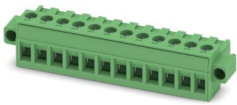

PCB connector, nominal cross section: 2.5 mm², color: green, nominal current: 12 A, rated voltage (III/2): 320 V, contact surface: Tin, contact connection type: Socket, number of potentials: 12, number of rows: 1, number of positions: 12, number of connections: 12, product range: MSTBT 2,5/..-STF, pitch: 5.08 mm, connection method: Screw connection with tension sleeve, screw head form: L Slotted, conductor/PCB connection direction: 0 °, locking clip: - without locking clip, plug-in system: COMBICON MSTB 2,5, locking: Screw locking mechanism, mounting: Screw flange, type of packaging: packed in cardboard

MSTBT 2,5/10-STF-5,08 - PCB connector

1805372

<https://www.phoenixcontact.com/us/products/1805372>



PCB connector, nominal cross section: 2.5 mm², color: green, nominal current: 12 A, rated voltage (III/2): 320 V, contact surface: Tin, contact connection type: Socket, number of potentials: 10, number of rows: 1, number of positions: 10, number of connections: 10, product range: MSTBT 2,5/..-STF, pitch: 5.08 mm, connection method: Screw connection with tension sleeve, screw head form: L Slotted, conductor/PCB connection direction: 0 °, locking clip: - without locking clip, plug-in system: COMBICON MSTB 2,5, locking: Screw locking mechanism, mounting: Screw flange, type of packaging: packed in cardboard

UKK 3-MSTB-5,08 AU 32L - Double-level terminal block

2770969

<https://www.phoenixcontact.com/us/products/2770969>

MSTBT 2,5/11-STF-5,08 - PCB connector

1805385

<https://www.phoenixcontact.com/us/products/1805385>

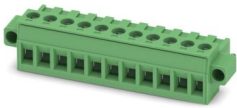

PCB connector, nominal cross section: 2.5 mm², color: green, nominal current: 12 A, rated voltage (III/2): 320 V, contact surface: Tin, contact connection type: Socket, number of potentials: 11, number of rows: 1, number of positions: 11, number of connections: 11, product range: MSTBT 2,5/...-STF, pitch: 5.08 mm, connection method: Screw connection with tension sleeve, screw head form: L Slotted, conductor/PCB connection direction: 0 °, locking clip: - without locking clip, plug-in system: COMBICON MSTB 2,5, locking: Screw locking mechanism, mounting: Screw flange, type of packaging: packed in cardboard

FKC 2,5/ 8-STF-5,08 - PCB connector

1873265

<https://www.phoenixcontact.com/us/products/1873265>

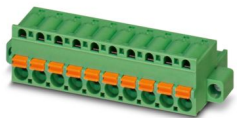

PCB connector, nominal cross section: 2.5 mm², color: green, nominal current: 12 A, rated voltage (III/2): 320 V, contact surface: Tin, contact connection type: Socket, number of potentials: 8, number of rows: 1, number of positions: 8, number of connections: 8, product range: FKC 2,5/...-STF, pitch: 5.08 mm, connection method: Push-in spring connection, conductor/PCB connection direction: 0 °, locking clip: - Locking clip, plug-in system: COMBICON MSTB 2,5, locking: Screw locking mechanism, mounting: Screw flange, type of packaging: packed in cardboard

UKK 3-MSTB-5,08 AU 32L - Double-level terminal block

2770969

<https://www.phoenixcontact.com/us/products/2770969>

FKC 2,5/ 5-STF-5,08 - PCB connector

1873236

<https://www.phoenixcontact.com/us/products/1873236>

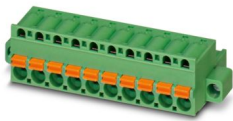

PCB connector, nominal cross section: 2.5 mm², color: green, nominal current: 12 A, rated voltage (III/2): 320 V, contact surface: Tin, contact connection type: Socket, number of potentials: 5, number of rows: 1, number of positions: 5, number of connections: 5, product range: FKC 2,5/...-STF, pitch: 5.08 mm, connection method: Push-in spring connection, conductor/PCB connection direction: 0 °, locking clip: - Locking clip, plug-in system: COMBICON MSTB 2,5, locking: Screw locking mechanism, mounting: Screw flange, type of packaging: packed in cardboard

FKC 2,5/ 2-STF-5,08 - PCB connector

1873207

<https://www.phoenixcontact.com/us/products/1873207>

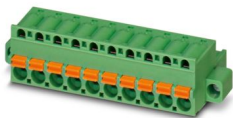

PCB connector, nominal cross section: 2.5 mm², color: green, nominal current: 12 A, rated voltage (III/2): 320 V, contact surface: Tin, contact connection type: Socket, number of potentials: 2, number of rows: 1, number of positions: 2, number of connections: 2, product range: FKC 2,5/...-STF, pitch: 5.08 mm, connection method: Push-in spring connection, conductor/PCB connection direction: 0 °, locking clip: - Locking clip, plug-in system: COMBICON MSTB 2,5, locking: Screw locking mechanism, mounting: Screw flange, type of packaging: packed in cardboard

UKK 3-MSTB-5,08 AU 32L - Double-level terminal block

2770969

<https://www.phoenixcontact.com/us/products/2770969>

FKC 2,5/14-STF-5,08 - PCB connector

1873320

<https://www.phoenixcontact.com/us/products/1873320>

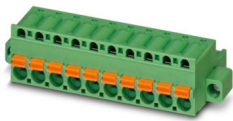

PCB connector, nominal cross section: 2.5 mm², color: green, nominal current: 12 A, rated voltage (III/2): 320 V, contact surface: Tin, contact connection type: Socket, number of potentials: 14, number of rows: 1, number of positions: 14, number of connections: 14, product range: FKC 2,5/..-STF, pitch: 5.08 mm, connection method: Push-in spring connection, conductor/PCB connection direction: 0 °, locking clip: - Locking clip, plug-in system: COMBICON MSTB 2,5, locking: Screw locking mechanism, mounting: Screw flange, type of packaging: packed in cardboard

FKC 2,5/ 9-STF-5,08 - PCB connector

1873278

<https://www.phoenixcontact.com/us/products/1873278>

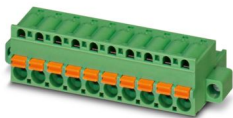

PCB connector, nominal cross section: 2.5 mm², color: green, nominal current: 12 A, rated voltage (III/2): 320 V, contact surface: Tin, contact connection type: Socket, number of potentials: 9, number of rows: 1, number of positions: 9, number of connections: 9, product range: FKC 2,5/..-STF, pitch: 5.08 mm, connection method: Push-in spring connection, conductor/PCB connection direction: 0 °, locking clip: - Locking clip, plug-in system: COMBICON MSTB 2,5, locking: Screw locking mechanism, mounting: Screw flange, type of packaging: packed in cardboard

UKK 3-MSTB-5,08 AU 32L - Double-level terminal block

2770969

<https://www.phoenixcontact.com/us/products/2770969>

QC 1/ 2-STF-5,08 - PCB connector

1883352

<https://www.phoenixcontact.com/us/products/1883352>

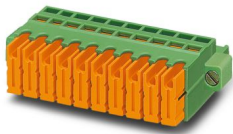

PCB connector, nominal cross section: 1 mm², color: green, nominal current: 10 A, rated voltage (III/2): 630 V, contact surface: Tin, contact connection type: Socket, number of potentials: 2, number of rows: 1, number of positions: 2, number of connections: 2, product range: QC 1/...-STF, pitch: 5.08 mm, connection method: Displacement connection, conductor/PCB connection direction: 0 °, locking clip: - without locking clip, plug-in system: COMBICON MSTB 2,5, locking: Screw locking mechanism, mounting: Screw flange, type of packaging: packed in cardboard

QC 1/ 3-STF-5,08 - PCB connector

1883365

<https://www.phoenixcontact.com/us/products/1883365>

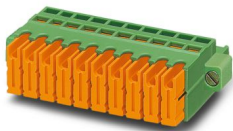

PCB connector, nominal cross section: 1 mm², color: green, nominal current: 10 A, rated voltage (III/2): 630 V, contact surface: Tin, contact connection type: Socket, number of potentials: 3, number of rows: 1, number of positions: 3, number of connections: 3, product range: QC 1/...-STF, pitch: 5.08 mm, connection method: Displacement connection, conductor/PCB connection direction: 0 °, locking clip: - without locking clip, plug-in system: COMBICON MSTB 2,5, locking: Screw locking mechanism, mounting: Screw flange, type of packaging: packed in cardboard

UKK 3-MSTB-5,08 AU 32L - Double-level terminal block

2770969

<https://www.phoenixcontact.com/us/products/2770969>

QC 1/ 7-STF-5,08 - PCB connector

1883404

<https://www.phoenixcontact.com/us/products/1883404>

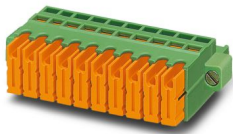

PCB connector, nominal cross section: 1 mm², color: green, nominal current: 10 A, rated voltage (III/2): 630 V, contact surface: Tin, contact connection type: Socket, number of potentials: 7, number of rows: 1, number of positions: 7, number of connections: 7, product range: QC 1/...-STF, pitch: 5.08 mm, connection method: Displacement connection, conductor/PCB connection direction: 0 °, locking clip: - without locking clip, plug-in system: COMBICON MSTB 2,5, locking: Screw locking mechanism, mounting: Screw flange, type of packaging: packed in cardboard

QC 1/15-STF-5,08 - PCB connector

1883886

<https://www.phoenixcontact.com/us/products/1883886>

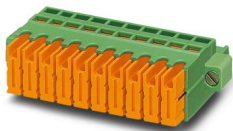

PCB connector, nominal cross section: 1 mm², color: green, nominal current: 10 A, rated voltage (III/2): 630 V, contact surface: Tin, contact connection type: Socket, number of potentials: 15, number of rows: 1, number of positions: 15, number of connections: 15, product range: QC 1/...-STF, pitch: 5.08 mm, connection method: Displacement connection, conductor/PCB connection direction: 0 °, locking clip: - without locking clip, plug-in system: COMBICON MSTB 2,5, locking: Screw locking mechanism, mounting: Screw flange, type of packaging: packed in cardboard

UKK 3-MSTB-5,08 AU 32L - Double-level terminal block

2770969

<https://www.phoenixcontact.com/us/products/2770969>

QC 1/12-STF-5,08 - PCB connector

1883459

<https://www.phoenixcontact.com/us/products/1883459>

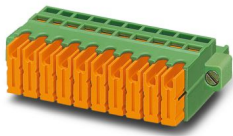

PCB connector, nominal cross section: 1 mm², color: green, nominal current: 10 A, rated voltage (III/2): 630 V, contact surface: Tin, contact connection type: Socket, number of potentials: 12, number of rows: 1, number of positions: 12, number of connections: 12, product range: QC 1/..-STF, pitch: 5.08 mm, connection method: Displacement connection, conductor/PCB connection direction: 0 °, locking clip: - without locking clip, plug-in system: COMBICON MSTB 2,5, locking: Screw locking mechanism, mounting: Screw flange, type of packaging: packed in cardboard

MSTBC 2,5/ 8-STZF-5,08 - PCB connector

1809792

<https://www.phoenixcontact.com/us/products/1809792>

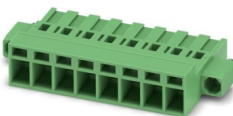

PCB connector, nominal cross section: 2.5 mm², color: green, nominal current: 12 A, rated voltage (III/2): 320 V, contact connection type: Socket, number of potentials: 8, number of rows: 1, number of positions: 8, number of connections: 8, product range: MSTBC 2,5/..-STZF, pitch: 5.08 mm, connection method: Crimp connection, conductor/PCB connection direction: 0 °, locking clip: - without locking clip, plug-in system: COMBICON MSTB 2,5, locking: Screw locking mechanism, mounting: Screw flange, type of packaging: packed in cardboard, Corresponding female crimp contacts with current [A] and conductor cross section range [mm²] data: 10A/MSTBC-MT 0,5-1,0 (3190564); 10A/MSTBC-MT 0,5-1,0 BA (3190645); 12A/MSTBC-MT 1,5-2,5 (3190551); 12A/MSTBC-MT 1,5-2,5 BA (3190658). BA = Bandkontakte

UKK 3-MSTB-5,08 AU 32L - Double-level terminal block



2770969

<https://www.phoenixcontact.com/us/products/2770969>

MSTBC 2,5/19-STZF-5,08 - PCB connector

1809909

<https://www.phoenixcontact.com/us/products/1809909>



PCB connector, nominal cross section: 2.5 mm², color: green, nominal current: 12 A, rated voltage (III/2): 320 V, contact connection type: Socket, number of potentials: 19, number of rows: 1, number of positions: 19, number of connections: 19, product range: MSTBC 2,5/..-STZF, pitch: 5.08 mm, connection method: Crimp connection, conductor/PCB connection direction: 0 °, locking clip: - without locking clip, plug-in system: COMBICON MSTB 2,5, locking: Screw locking mechanism, mounting: Screw flange, type of packaging: packed in cardboard, Corresponding female crimp contacts with current [A] and conductor cross section range [mm²] data: 10A/MSTBC-MT 0,5-1,0 (3190564); 10A/MSTBC-MT 0,5-1,0 BA (3190645); 12A/MSTBC-MT 1,5-2,5 (3190551); 12A/MSTBC-MT 1,5-2,5 BA (3190658). BA = Bandkontakte

MSTBC 2,5/ 9-STZF-5,08 - PCB connector

1809802

<https://www.phoenixcontact.com/us/products/1809802>



PCB connector, nominal cross section: 2.5 mm², color: green, nominal current: 12 A, rated voltage (III/2): 320 V, contact connection type: Socket, number of potentials: 9, number of rows: 1, number of positions: 9, number of connections: 9, product range: MSTBC 2,5/..-STZF, pitch: 5.08 mm, connection method: Crimp connection, conductor/PCB connection direction: 0 °, locking clip: - without locking clip, plug-in system: COMBICON MSTB 2,5, locking: Screw locking mechanism, mounting: Screw flange, type of packaging: packed in cardboard, Corresponding female crimp contacts with current [A] and conductor cross section range [mm²] data: 10A/MSTBC-MT 0,5-1,0 (3190564); 10A/MSTBC-MT 0,5-1,0 BA (3190645); 12A/MSTBC-MT 1,5-2,5 (3190551); 12A/MSTBC-MT 1,5-2,5 BA (3190658). BA = Bandkontakte

UKK 3-MSTB-5,08 AU 32L - Double-level terminal block



2770969

<https://www.phoenixcontact.com/us/products/2770969>

MSTBC 2,5/ 6-STZF-5,08 - PCB connector

1809776

<https://www.phoenixcontact.com/us/products/1809776>

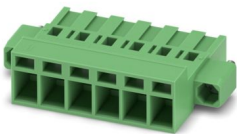

PCB connector, nominal cross section: 2.5 mm², color: green, nominal current: 12 A, rated voltage (III/2): 320 V, contact connection type: Socket, number of potentials: 6, number of rows: 1, number of positions: 6, number of connections: 6, product range: MSTBC 2,5/..-STZF, pitch: 5.08 mm, connection method: Crimp connection, conductor/PCB connection direction: 0 °, locking clip: - without locking clip, plug-in system: COMBICON MSTB 2,5, locking: Screw locking mechanism, mounting: Screw flange, type of packaging: packed in cardboard, Corresponding female crimp contacts with current [A] and conductor cross section range [mm²] data: 10A/MSTBC-MT 0,5-1,0 (3190564); 10A/MSTBC-MT 0,5-1,0 BA (3190645); 12A/MSTBC-MT 1,5-2,5 (3190551); 12A/MSTBC-MT 1,5-2,5 BA (3190658). BA = Bandkontakte

MSTBC 2,5/18-STZF-5,08 - PCB connector

1809899

<https://www.phoenixcontact.com/us/products/1809899>

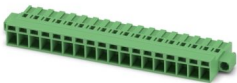

PCB connector, nominal cross section: 2.5 mm², color: green, nominal current: 12 A, rated voltage (III/2): 320 V, contact connection type: Socket, number of potentials: 18, number of rows: 1, number of positions: 18, number of connections: 18, product range: MSTBC 2,5/..-STZF, pitch: 5.08 mm, connection method: Crimp connection, conductor/PCB connection direction: 0 °, locking clip: - without locking clip, plug-in system: COMBICON MSTB 2,5, locking: Screw locking mechanism, mounting: Screw flange, type of packaging: packed in cardboard, Corresponding female crimp contacts with current [A] and conductor cross section range [mm²] data: 10A/MSTBC-MT 0,5-1,0 (3190564); 10A/MSTBC-MT 0,5-1,0 BA (3190645); 12A/MSTBC-MT 1,5-2,5 (3190551); 12A/MSTBC-MT 1,5-2,5 BA (3190658). BA = Bandkontakte

UKK 3-MSTB-5,08 AU 32L - Double-level terminal block



2770969

<https://www.phoenixcontact.com/us/products/2770969>

SZS 0,6X3,5 - Screwdriver

1205053

<https://www.phoenixcontact.com/us/products/1205053>



Actuation tool, for ST terminal blocks, insulated, also suitable for use as a bladed screwdriver, size: 0.6 x 3.5 x 100 mm, 2-component grip, with non-slip grip

Phoenix Contact 2024 © - all rights reserved

<https://www.phoenixcontact.com>

Phoenix Contact USA
586 Fulling Mill Road
Middletown, PA 17057, United States
(+717) 944-1300
info@phoenixcon.com