

IGBT Module/IGBT 模块

Features/特性

- 1200V,300A
- 采用SPT+技术的低 $V_{CE(sat)}$
- Low $V_{CE(sat)}$ with SPT+ technology
- 具有正温度系数的 $V_{CE(sat)}$
- $V_{CE(sat)}$ with positive temperature coefficient
- 包括快速软恢复反并联前馈
- Including fast & soft recovery anti-parallel FWD
- 高短路能力 (10us)
- High short circuit capability(10us)
- 低电感模块结构
- Low inductance module structure

Mechanical Features/机械特性

绝缘的基板
Isolated Base Plate
标准封装
Standard Housing

Applications/应用

- 电机驱动逆变器
Inverter for motor drive
- 交流和直流伺服驱动放大器
AC and DC servo drive amplifier
- 不间断电源
UPS (Uninterruptible Power Supplies)
- 光伏储能
Photovoltaic energy storage



IGBT Power Module

Equivalent Circuit Schematic/等效电路图

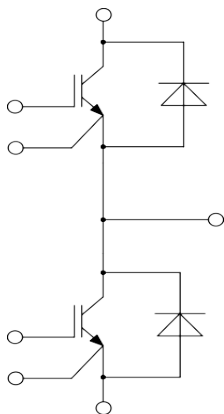

IGBT-Absolute Maximum Ratings (@ $T_C = 25^\circ\text{C}$ unless otherwise specified)

Symbol	Parameter	Value	Units
V_{CES}	Collector-Emitter Voltage 集电极-发射极电压	1200	V
V_{GES}	Gate-Emitter Peak Voltage 栅极-发射极峰值电压	± 20	V
I_C	Continuous Collector Current 连续集电极直流电流	$T_C = 100^\circ\text{C}$ 300	A
I_{CM}	Pulsed Collector Current 集电极重复峰值电流	$t_p=1\text{ms}$ 600	A
P_{tot}	Total Power Dissipation 总功率功耗	$T_{vj} \text{ max} = 150^\circ\text{C}$ 1600	W

IGBT Characteristics (@ $T_C = 25^\circ\text{C}$ unless otherwise specified)

Symbol	Parameter	Conditions	Min.	Typ.	Max.	Unit
$V_{CE \text{ sat}}$	Collector to Emitter Saturation Voltage 集电极-发射极饱和电压	$I_C = 300 \text{ A}, V_{GE} = 15 \text{ V}$	$T_{vj}=25^\circ\text{C}$	1.8		V
			$T_{vj}=125^\circ\text{C}$	2.1		
$V_{GE \text{ th}}$	Gate-Emitter Threshold Voltage 栅极阈值电压	$I_C = 1.0 \text{ mA}, V_{CE} = V_{GE}, T_{vj} = 25^\circ\text{C}$		5.3		V
I_{CES}	Collector-Emitter Cut-off Current 集电极-发射极截止电流	$V_{CE} = 1200 \text{ V}, V_{GE} = 0 \text{ V}, T_{vj} = 25^\circ\text{C}$			5.0	mA
I_{GES}	Gate-emitter Leakage Current 栅极-发射极漏电流	$V_{CE} = 0 \text{ V}, V_{GE} = 20 \text{ V}, T_{vj} = 25^\circ\text{C}$			400.0	nA
R_{Gint}	Internal Gate Resistor 内部栅极电阻			3.0		Ω
Q_G	Gate Charge 栅极电荷	$V_{GE}=-15\dots+15\text{V}$		1.5		μC
C_{ies}	Input Capacitance 输入电容	$V_{CE}=25\text{V}, f=1\text{MHz},$ $V_{GE}=0\text{V}$		19		nF
C_{res}	Reverse Transfer Capacitance 反向传输电容				0.81	
t_{don}	Turn-on Delay Time 开通延迟时间	$V_{CE}=600\text{V}, I_C=300\text{A},$ $R_G=15\Omega, V_{GE}=\pm 15\text{V}$	$T_{vj}=25^\circ\text{C}$	356		nS
			$T_{vj}=125^\circ\text{C}$	367		
t_r	Rise Time 上升时间	$V_{CE}=600\text{V}, I_C=300\text{A},$ $R_G=15\Omega, V_{GE}=\pm 15\text{V}$	$T_{vj}=25^\circ\text{C}$	221		nS
			$T_{vj}=125^\circ\text{C}$	260		
t_{doff}	Turn-off Delay Time 关断延迟时间	$V_{CE}=600\text{V}, I_C=300\text{A},$ $R_G=15\Omega, V_{GE}=\pm 15\text{V}$	$T_{vj}=25^\circ\text{C}$	458		nS
			$T_{vj}=125^\circ\text{C}$	477		
t_f	Fall Time 下降时间	$V_{CE}=600\text{V}, I_C=300\text{A},$ $R_G=15\Omega, V_{GE}=\pm 15\text{V}$	$T_{vj}=25^\circ\text{C}$	139		nS
			$T_{vj}=125^\circ\text{C}$	154		
E_{on}	Turn-On Switching Loss Per Pulse 开通损耗能量	$V_{CE}=600\text{V}, I_C=300\text{A},$ $R_G=15\Omega, V_{GE}=\pm 15\text{V}$	$T_{vj}=25^\circ\text{C}$	46		mJ
			$T_{vj}=125^\circ\text{C}$	65		
E_{off}	Turn-off Energy Loss Per Pulse 关断损耗能量	$V_{CE}=600\text{V}, I_C=300\text{A},$ $R_G=15\Omega, V_{GE}=\pm 15\text{V}$	$T_{vj}=25^\circ\text{C}$	69		mJ
			$T_{vj}=125^\circ\text{C}$	74		
I_{sc}	SC Data 短路数据	$V_{GE} = 15 \text{ V}, V_{CC} = 600 \text{ V}, t_p \leq 10 \mu\text{s}$ $V_{CEM} \leq 1200 \text{ V}, T_{vj} = 150^\circ\text{C}$		986		A
R_{thJC}	Thermal Resistance, Junction to Case 结-外壳热阻	per IGBT		0.093		K/W
R_{thCH}	Thermal Resistance, Case to Heatsink 外壳-散热器热阻	per IGBT		0.032		K/W

Diode-Absolute Maximum Ratings (@ $T_C = 25^\circ\text{C}$ unless otherwise specified)

Symbol	Parameter	Value	Units
V_{RRM}	Repetitive Peak Reverse Voltage 反向重复峰值电压	1200	V
I_F	Diode Continuous Forward Current 连续正向直流电流	300	A
I_{FM}	Diode Maximum Forward Current 正向重复峰值电流	$t_p=1\text{ms}$ 600	A

Diode Characteristics (@ $T_C = 25^\circ\text{C}$ unless otherwise specified)

Symbol	Parameter	Conditions	Min.	Typ.	Max.	Unit
V_F	Diode Forward Voltage 正向电压	$I_C = 300\text{ A}$	$T_{vj}=25^\circ\text{C}$		1.8	V
			$T_{vj}=125^\circ\text{C}$		1.9	
Q_r	Recovered Charge 恢复电荷	$I_F = 300\text{ A}, V_R = 600\text{ V}, R_G = 15\ \Omega, V_{GE} = -15\text{ V}$	$T_{vj}=25^\circ\text{C}$		21.7	μC
			$T_{vj}=125^\circ\text{C}$		35	
I_{rm}	Peak Reverse Recovery Current 反向恢复峰值电流	$I_F = 300\text{ A}, V_R = 600\text{ V}, R_G = 15\ \Omega, V_{GE} = -15\text{ V}$	$T_{vj}=25^\circ\text{C}$		75	A
			$T_{vj}=125^\circ\text{C}$		81	
t_{rr}	Reverse Recovery Time 反向恢复时间	$I_F = 300\text{ A}, V_R = 600\text{ V}, R_G = 15\ \Omega, V_{GE} = -15\text{ V}$	$T_{vj}=25^\circ\text{C}$		511	nS
			$T_{vj}=125^\circ\text{C}$		772	
E_{rec}	Reverse Recovery Energy 反向恢复损耗	$I_F = 300\text{ A}, V_R = 600\text{ V}, R_G = 15\ \Omega, V_{GE} = -15\text{ V}$	$T_{vj}=25^\circ\text{C}$		6.4	mJ
			$T_{vj}=125^\circ\text{C}$		9.9	
R_{thJC}	Thermal Resistance, Junction to Case 结-外壳热阻	per Diode		0.150		K/W
R_{thCH}	Thermal Resistance, Case to Heatsink 结-散热器热阻	per Diode		0.052		K/W

Module

Symbol	Parameter	Conditions	Min.	Typ.	Max.	Unit
V _{ISOL}	Isolation Test Voltage 绝缘测试电压	RMS, f = 50 Hz, t = 1 min	2500			V
T _{vj max}	Maximum Junction Temperature 最大结温				150	°C
T _{vj op}	Operating Junction Temperature 工作结温		-40		125	°C
T _{STG}	Storage Temperature Range 储存温度		-40		125	°C
R _{thCH}	Case to Heatsink 外壳-散热器热阻	per Module		0.01		K/W
M _s	Mounting Torque For Modul Mounting 模块安装的安装扭矩	Recommended(M6)	3		6	Nm
M _t	Terminal Connection Torque 端子连接扭矩	Recommended(M5)	2.5		5	Nm
G	Weight 重量			320		g

输出特性IGBT,逆变器 (典型)
output characteristic IGBT,Inverter (typical)
 $I_C=f(V_{CE})$
 $V_{GE}=15V$

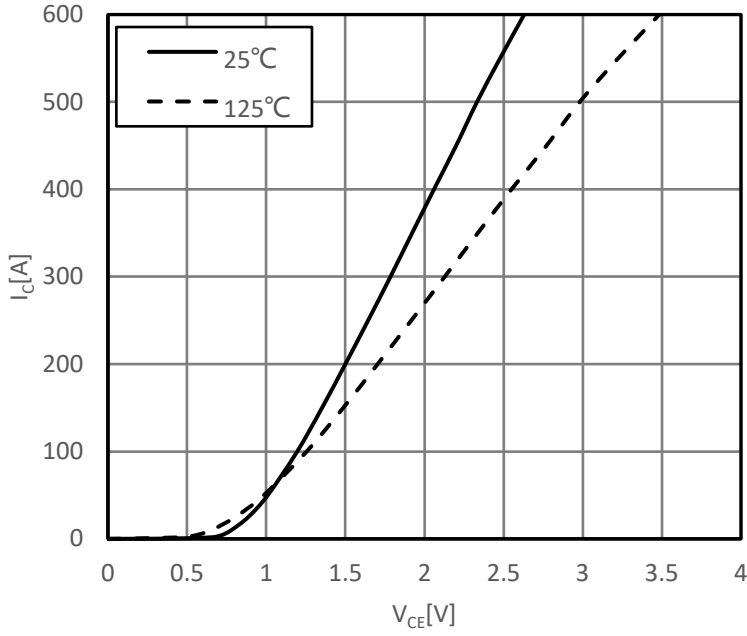

输出特性IGBT,逆变器 (典型)
output characteristic IGBT,Inverter (typical)
 $I_C=f(V_{CE})$
 $T_{vj}=125^\circ C$

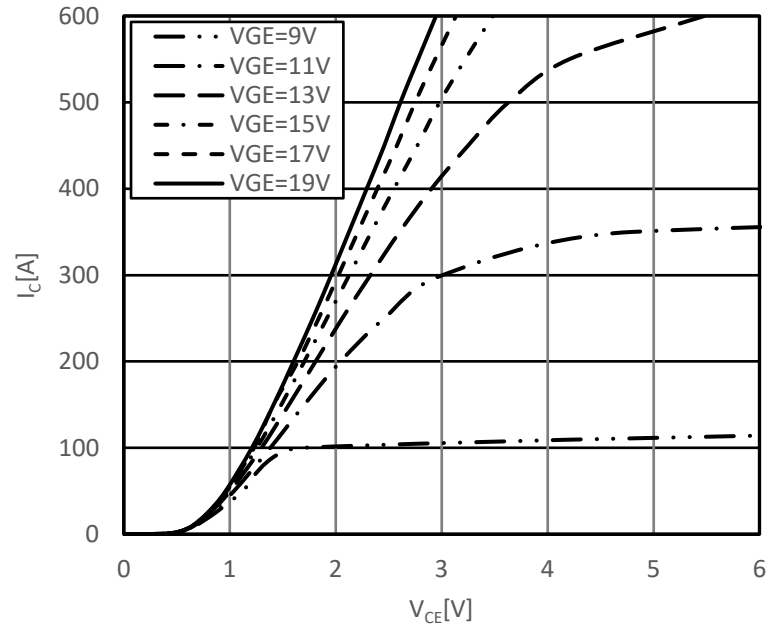

传输特性IGBT,逆变器(典型)
transfer characteristic IGBT,Inverter(typical)
 $I_C=f(V_{GE})$
 $V_{CE}=20V$

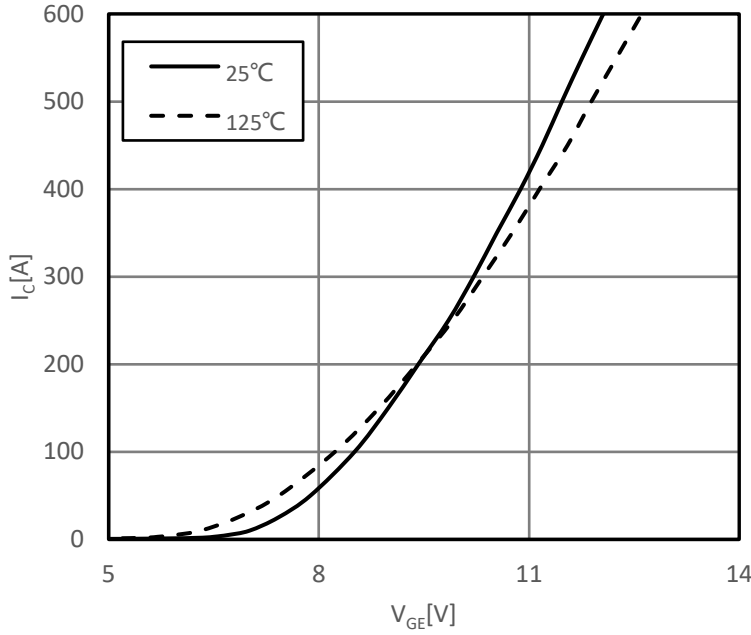

开关损耗IGBT,逆变器 (典型)
switching losses IGBT,Inverter(typical)
 $E_{on}=f(R_G), E_{off}=f(R_G)$
 $V_{GE}=\pm 15V, I_C=300A, V_{CE}=600V$

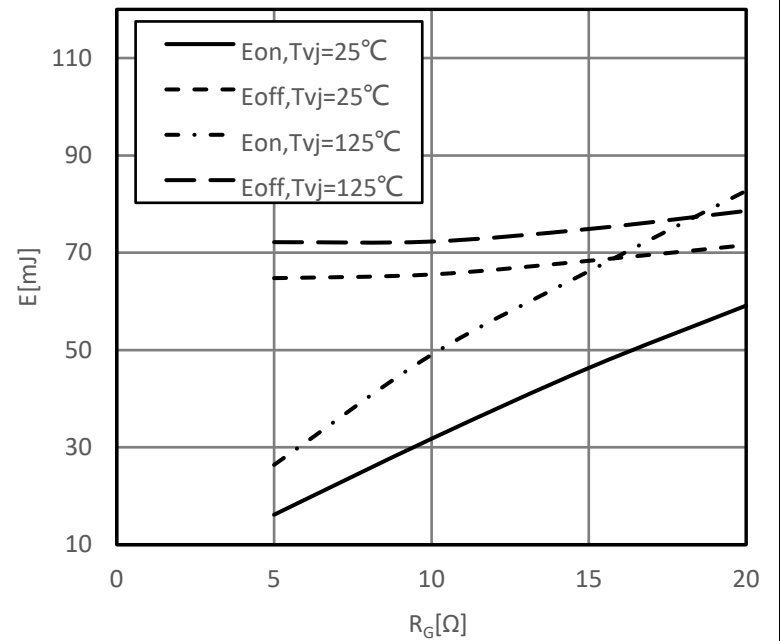

瞬态热阻抗IGBT,逆变器
transient thermal impedance IGBT, Inverter
 $Z_{thJC}=f(t)$

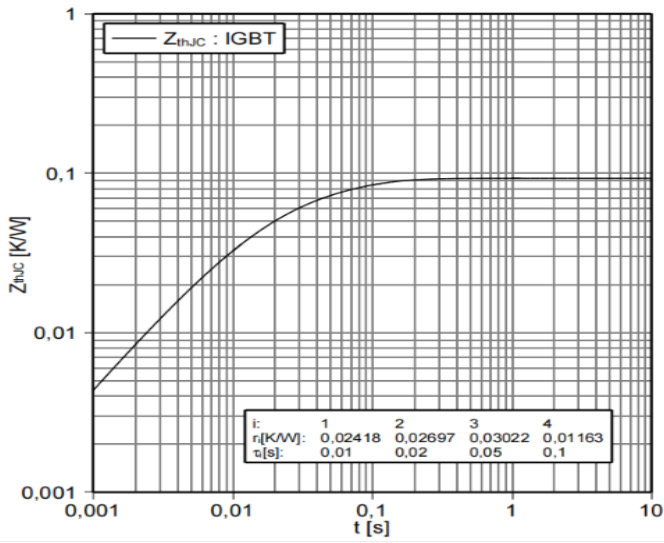

开关损耗二极管,逆变器 (典型)
switching losses Diode, Inverter (typical)
 $E_{rec}=f(R_G)$
IF=300A, VCE=600V

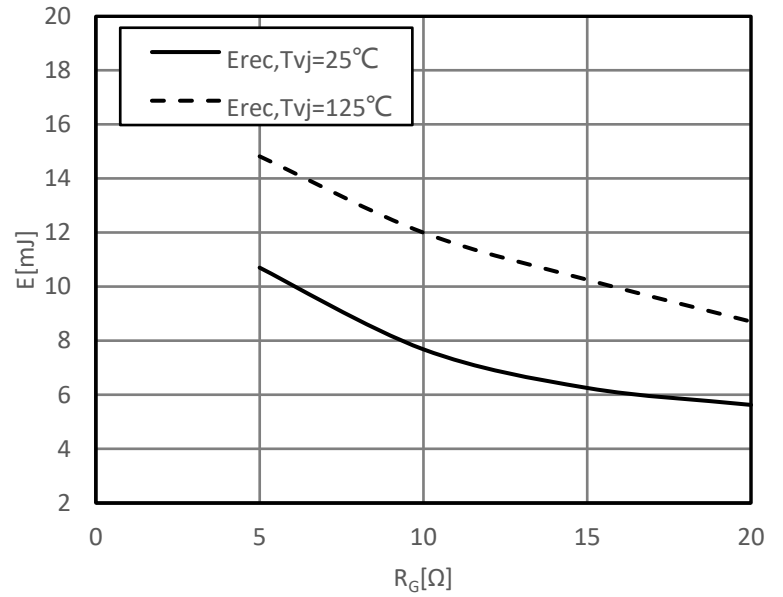

正向偏压特性二极管,逆变器 (典型)
forward characteristic of Diode, Inverter (typical)
IF=f(VF)

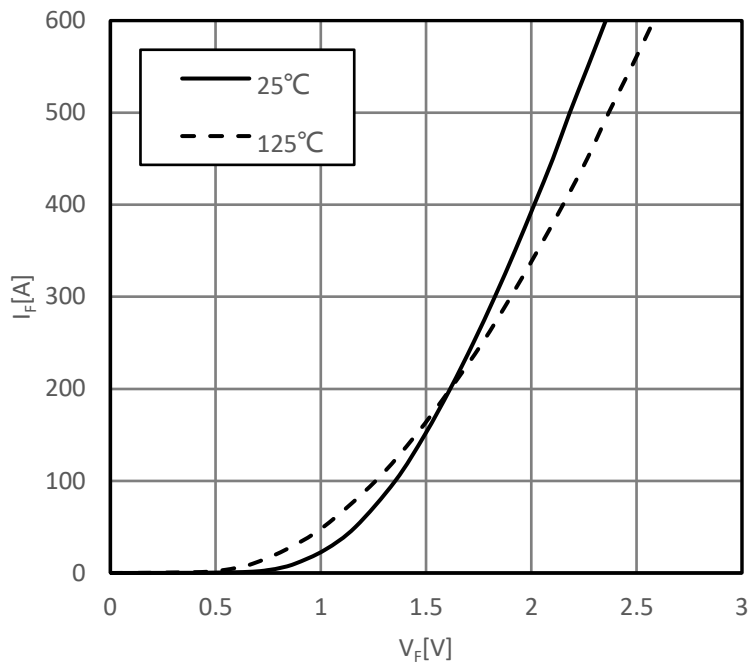

瞬态热阻抗二极管,逆变器
transient thermal impedance Diode, Inverter
 $Z_{thJC}=f(t)$

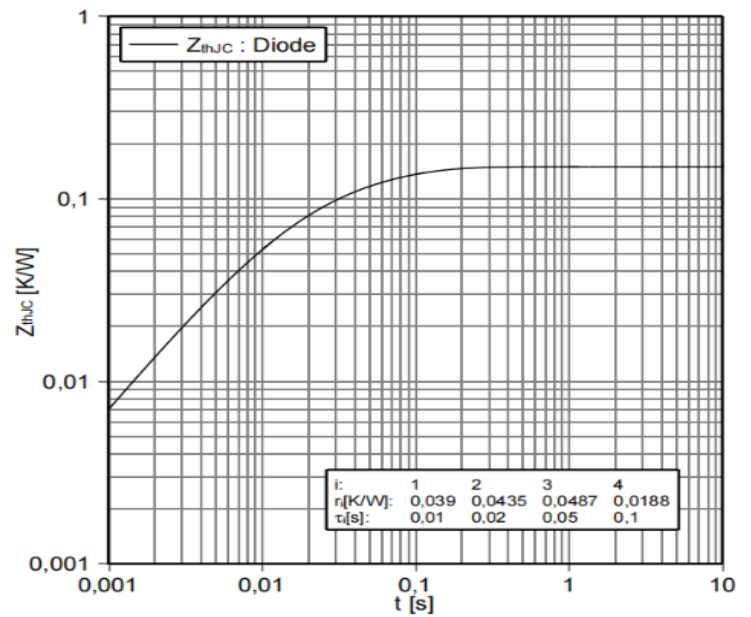

接线图/circuit_diagram_headline

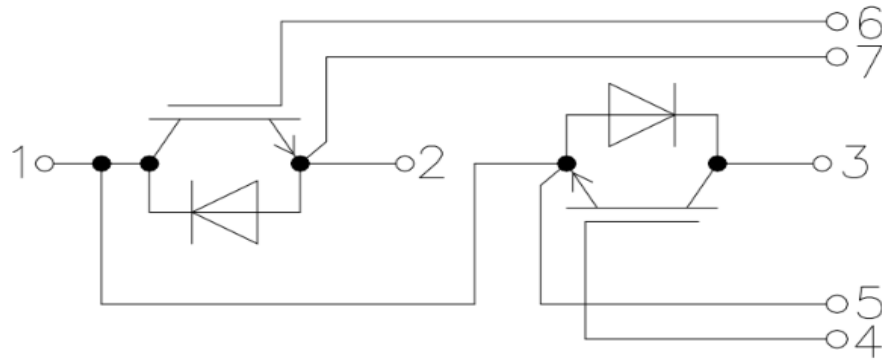

封装尺寸/package outlines

