

4

3

2

1

THIS DRAWING IS UNPUBLISHED.

RELEASED FOR PUBLICATION

2016

© COPYRIGHT 2016 BY Tyco Electronics Japan G.K. ALL RIGHTS RESERVED.

REVISIONS

P	LTR	DESCRIPTION	DATE	DWN	APVD
	A	RELEASED	28OCT2016	SH	MS
	B	REVISED ECR-21-002682	4JUN2021	SH	TY



PAPER BOX 段ボール	TRAY トレイ	1.7g	( $\phi$ 3.2)	2291354-2
PAPER BOX 段ボール	TRAY トレイ	1.7g	( $\phi$ 4.8)	2291354-1
OUTER 外装	INNER 内装	WEIGHT	APPLICABLE CABLE O.D. (REFERENCE) 適用ケーブル外径 (参照)	PART NO.
PACKING 梱包形態				

1. THIS PART IS A COMPONENT OF PLUG CONNECTOR,  
SEE 114-5542 ABOUT NECESSARY COMPONENTS AND ASSEMBLING

2. IF THE DETAIL OF CABLE ASSEMBLY IS NEEDED, CONTACT OUR SALES PERSON

1. 本品はプラグのコンポーネントで、  
プラグに必要なコンポーネントおよびプラグ組立方法については114-5542を参照

2. 組付けケーブルの詳細が必要な場合は、お問い合わせください

THIS DRAWING IS A CONTROLLED DOCUMENT.		DWN S. HIROTA 28OCT2016	 <b>TE Connectivity</b>	
DIMENSIONS: 単位: 概 mm		CHK T. YAMAMOTO 28OCT2016		
		APVD M. SHIMAOKA 28OCT2016	NAME 名称 PLUG SHELL 0.50 HSL CONNECTER	
TOLERANCES UNLESS OTHERWISE SPECIFIED: 一般公差 ±0.3 0-PLC ± 1-PLC ±0.5 2-PLC ±0.13 3-PLC ±0.013 4-PLC ±0.000J ANGLES ±3		PRODUCT SPEC 製品規格 108-140085	SIZE A3	
MATERIAL 材料 COPPER ALLOY		APPLICATION SPEC 取付適用規格 114-5542	CAGE CODE 00779	DRAWING NO 番号 C-2291354
FINISH 仕上 PRE-TIN		WEIGHT SEE TABLE	RESTRICTED TO -	
CUSTOMER DRAWING		SCALE 尺度 4:1		SHEET 1 OF 2
				REV B

1470-19 (3/13)

THIS DRAWING IS UNPUBLISHED.

RELEASED FOR PUBLICATION

2016

© COPYRIGHT 2016 BY Tyco Electronics Japan G.K. ALL RIGHTS RESERVED.

REVISIONS

変更

P	LTR	DESCRIPTION	DATE	DWN	APVD
	-	SEE SHEET 1	-	-	-

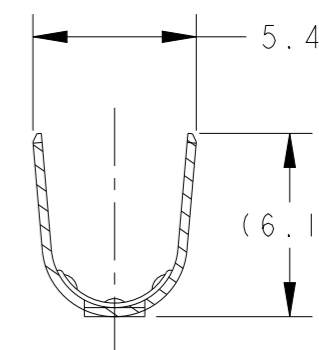
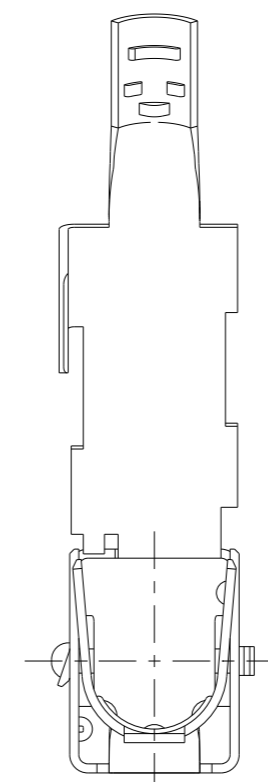
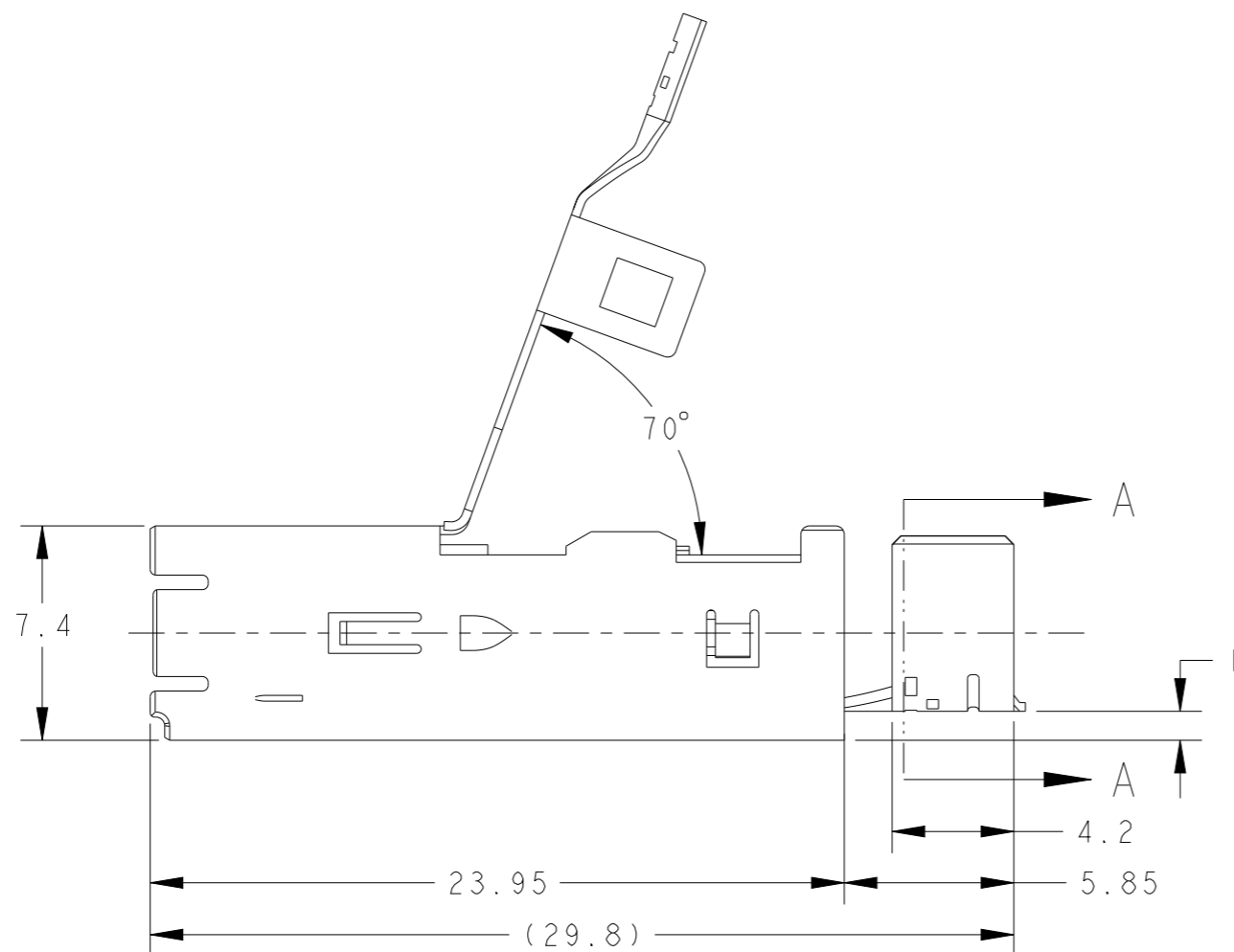
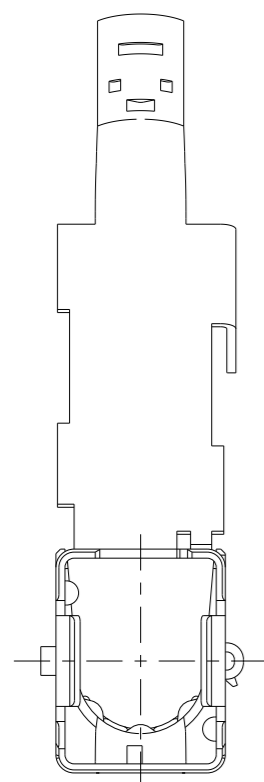
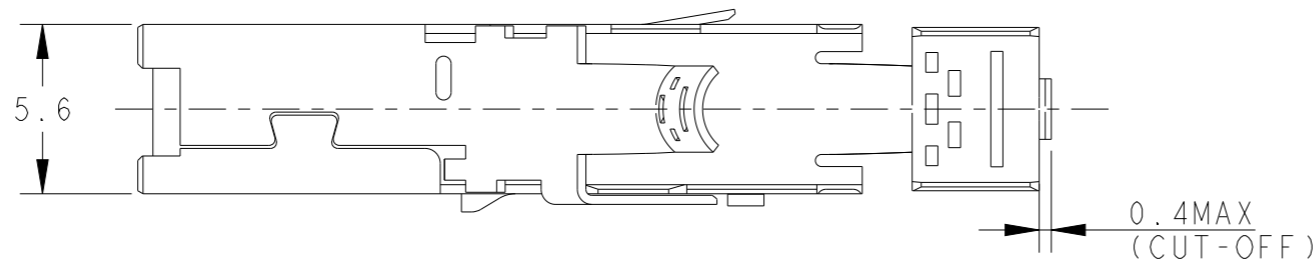

A - A

THIS DRAWING IS A CONTROLLED DOCUMENT.

DIMENSIONS:  
単位: 概  
mm

TOLERANCES UNLESS  
OTHERWISE SPECIFIED:

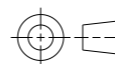

- 一般公差 ±0.3
- 0 PLC ±
- 1 PLC ±0.5
- 2 PLC ±0.13
- 3 PLC ±0.013
- 4 PLC ±0.000J
- ANGLES ±3

MATERIAL  
材料 SEE SHEET 1

FINISH  
仕上 SEE SHEET 1

DWN 28OCT2016

S. HIROTA

CHK 28OCT2016

T. YAMAMOTO

APVD 28OCT2016

M. SHIMAOKA

PRODUCT SPEC  
製品規格

SEE SHEET 1

APPLICATION SPEC  
取付適用規格

SEE SHEET 1

WEIGHT  
重量 SEE SHEET 1

NAME  
名称 PLUG SHELL  
0.50 HSL CONNECTER

SIZE CAGE CODE DRAWING NO RESTRICTED TO

A3 00779 C-2291354

CUSTOMER DRAWING

SCALE  
尺度 4:1

SHEET 2 OF 2

REV B

