



## Description

The BTA16 Triac series are suitable for general purpose mains power AC switching. They can be used as ON/OFF function in applications such as static relays, heating regulation or induction motor starting circuit. They are also recommended for phase control operations in light dimmers and appliance motors speed controllers.

## Main Features

Symbol	value	unit
$I_{T(RMS)}$	16	A
$V_{DRM}/V_{RRM}$	600	V
$I_{TSM}$	160	A

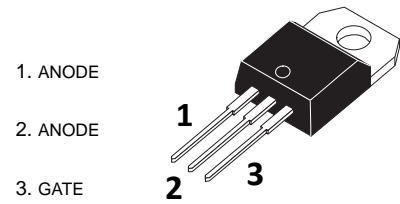

TO-220A  
(TO-220)



## Absolute maximum ratings

Symbol	Parameters			Value	Unit
$I_{T(RMS)}$	RMS on-state current (full sine wave)		$T_c = 100\text{ }^\circ\text{C}$	16	A
$I_{TSM}$	Non repetitive surge peak on-state current (full cycle, $T_j$ initial = $25\text{ }^\circ\text{C}$ )	$F = 50\text{ Hz}$	$t_p = 20\text{ ms}$	160	A
		$F = 60\text{ Hz}$	$t_p = 16.7\text{ ms}$	168	
$I^2t$	$I^2t$ value for fusing	$t_p = 10\text{ ms}$		144	$\text{A}^2\text{s}$
$di/dt$	Critical rate of rise of on-state current $I_G = 2 \times I_{GT}$ , $t_r \leq 100\text{ ns}$	$F = 120\text{ Hz}$	$T_j = 125\text{ }^\circ\text{C}$	50	$\text{A}/\mu\text{s}$
$V_{DSM}/V_{RSM}$	Non repetitive surge peak off-state voltage	$t_p = 10\text{ ms}$	$T_j = 25\text{ }^\circ\text{C}$	$V_{DRM}/V_{RRM} + 100$	V
$I_{GM}$	Peak gate current	$t_p = 20\text{ }\mu\text{s}$	$T_j = 125\text{ }^\circ\text{C}$	4	A
$P_{G(AV)}$	Average gate power dissipation		$T_j = 125\text{ }^\circ\text{C}$	1	W
$T_{stg}$	Storage junction temperature range			-40 to +150	$^\circ\text{C}$
$T_j$	Operating junction temperature range			-40 to +125	$^\circ\text{C}$



### Static Electrical Characteristics

Symbol	Test conditions	$T_j$		Value	Unit
$V_T^{(1)}$	$I_{TM} = 22.5 \text{ A}$ , $t_p = 380 \mu\text{s}$	25 °C	Max.	1.55	V
$V_{TO}^{(1)}$	threshold on-state voltage	125 °C	Max.	0.85	V
$R_D^{(1)}$	Dynamic resistance	125 °C	Max.	25	mΩ
$I_{DRM}/I_{RRM}$	$V_{DRM} = V_{RRM}$	25 °C	Max.	5	μA
		125 °C		2	mA

1. For both polarities of A2 referenced to A1

### Electrical Characteristics

( $T_j = 25 \text{ °C}$ , unless otherwise specified) - standard (4 quadrants)

Symbol	Parameters	Quadrant		BTA16	Unit
$I_{GT}^{(1)}$	$V_D = 12 \text{ V}$ , $R_L = 33 \Omega$	I - II - III	Max.	25	mA
		IV		50	
$V_{GT}$		All	Max.	1.3	V
$V_{GD}$	$V_D = V_{DRM}$ , $R_L = 3.3 \text{ k}\Omega$ , $T_j = 125 \text{ °C}$	All	Min.	0.2	V
$I_H^{(2)}$	$I_T = 500 \text{ mA}$		Max.	25	mA
$I_L$	$I_G = 1.2 I_{GT}$	I - III - IV	Max.	40	mA
		II	Max.	80	

Symbol	Parameters	Quadrant		BTA16	Unit
$dV/dt^{(2)}$	$V_D = 67 \% V_{DRM}$ gate open, $T_j = 125 \text{ °C}$		Min.	200	V/μs
$(dI/dt)_c^{(2)}$	$(dI/dt)_c = 7 \text{ A/ms}$ , $T_j = 125 \text{ °C}$		Min.	5	V/μs

1. Minimum  $I_{GT}$  is guaranteed at 5 % of  $I_{GT}$  max.

2. For both polarities of A2 referenced to A1



## Electrical Characteristics

( $T_j = 25\text{ }^\circ\text{C}$ , unless otherwise specified) - Snubberless and logic level (3quadrants)

Symbol	Parameters	Quadrant		BTA16	Unit
$I_{GT}^{(1)}$	$V_D = 12\text{ V}$ , $R_L = 30\ \Omega$	I - II - III	Max.	35	mA
$V_{GT}$			Max.	1.3	V
$V_{GD}$			Min.	0.2	V
$I_H^{(2)}$	$I_T = 500\text{ mA}$		Max.	35	mA
$I_L$	$I_G = 1.2 I_{GT}$	I - III	Max.	50	mA
		II	Max.	60	
$(dV/dt)^{(2)}$	$V_D = 67\% V_{DRM}$ gate open, $T_j = 125\text{ }^\circ\text{C}$		Min.	500	V/ $\mu\text{s}$
$(dI/dt)^{(2)}$	$(dV/dt)_c = 0.1\text{ V}/\mu\text{s}$ , $T_j = 125\text{ }^\circ\text{C}$		Min.	8.5	A/ms
	$(dV/dt)_c = 10\text{ V}/\mu\text{s}$ , $T_j = 125\text{ }^\circ\text{C}$			3.0	
	Without snubber, $T_j = 125\text{ }^\circ\text{C}$			8.5	

1. Minimum  $I_{GT}$  is guaranteed at 5 % of  $I_{GT}$  max.
2. For both polarities of A2 referenced to A1

## Thermal resistance

Symbol	Parameters	Value	Unit
$R_{th(j-c)}$	Max. junction to case (AC)	2.1	$^\circ\text{C}/\text{W}$
$R_{th(j-a)}$	Junction to ambient	60	



### Characteristics (curves)

Maximum power dissipation versus on-state RMS current (full cycle)

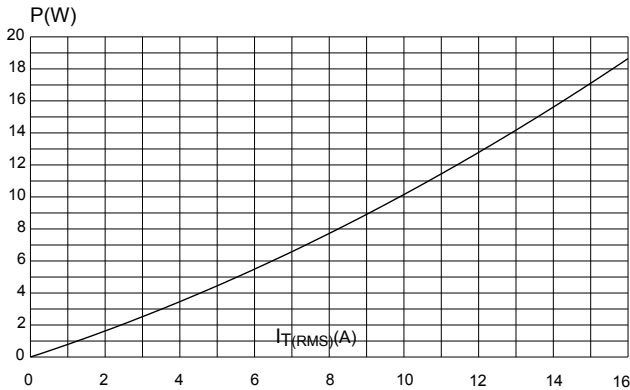

RMS on-state current versus case temperature (full cycle)

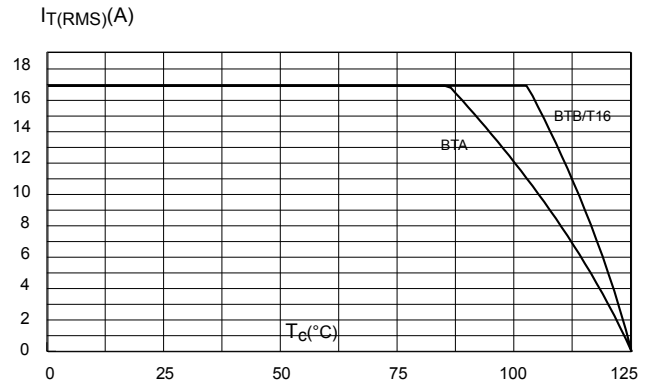

Relative variation of thermal impedance versus pulse duration

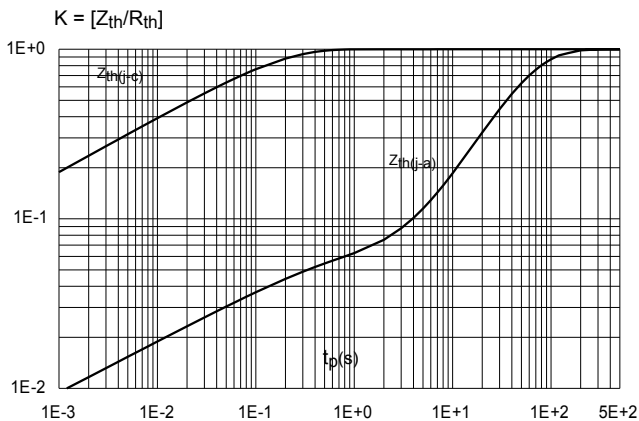

On-state characteristics (maximum values)

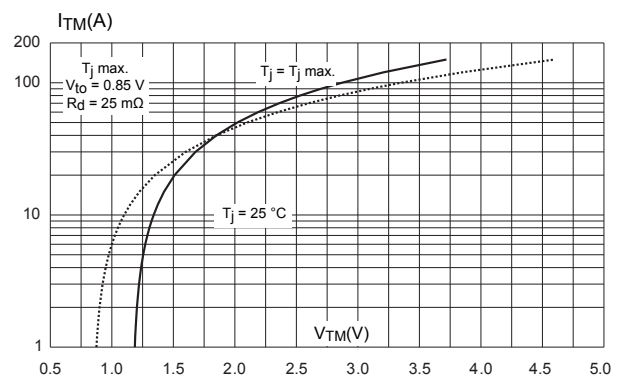

Non-repetitive surge peak on-state current for a sinusoidal

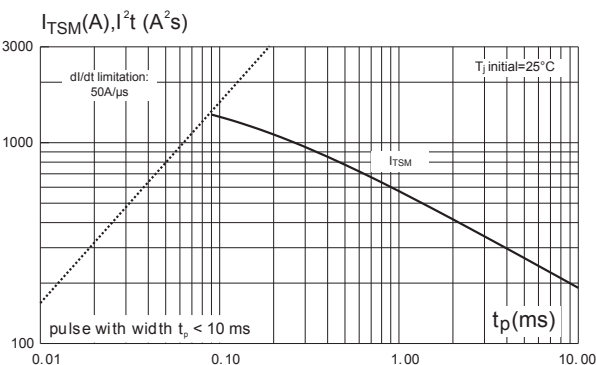

Relative variation of gate trigger current

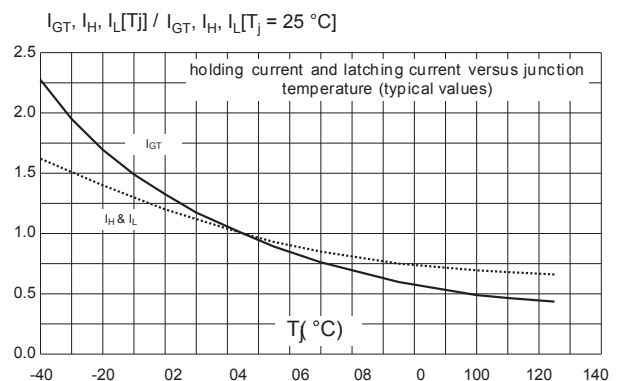



Relative variation of critical rate of decrease of main current versus  $(dV/dt)_c$  (typical values)

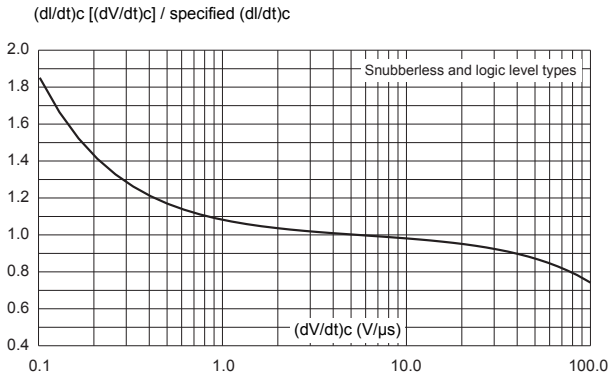

Relative variation of critical rate of decrease of main current versus (junction temperature) (typical values)

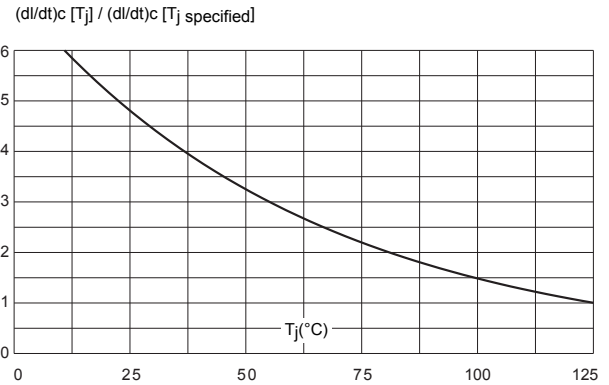

Surge peak on-state current versus number of cycles

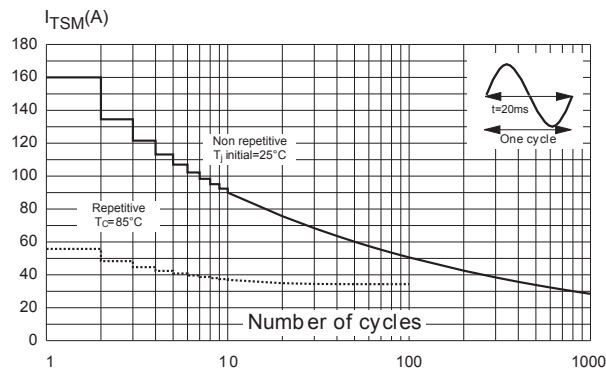



**Package Information**  
**TO-220A**  
**(TO-220)**

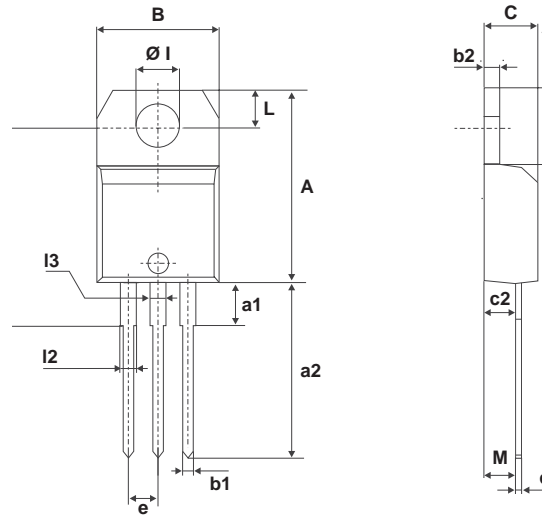

Ref.	Dimensions					
	Millimeters			Inches		
	Min.	Typ.	Max.	Min.	Typ.	Max.
A	15.20		15.90	0.598		0.625
a1		3.75			0.147	
a2	13.00		14.00	0.511		0.551
B	10.00		10.40	0.393		0.409
b1	0.61		0.88	0.024		0.034
b2	1.23		1.32	0.048		0.051
C	4.40		4.60	0.173		0.181
c1	0.49		0.70	0.019		0.027
c2	2.40		2.72	0.094		0.107
e	2.40		2.70	0.094		0.106
F	6.20		6.60	0.244		0.259
ØI	3.75		3.85	0.147		0.151
I4	15.80	16.40	16.80	0.622	0.646	0.661
L	2.65		2.95	0.104		0.116
I2	1.14		1.70	0.044		0.066
I3	1.14		1.70	0.044		0.066
M		2.60			0.102	



### Attention

- Any and all HUA XUAN YANG ELECTRONICS products described or contained herein do not have specifications that can handle applications that require extremely high levels of reliability, such as life-support systems, aircraft's control systems, or other applications whose failure can be reasonably expected to result in serious physical and/or material damage. Consult with your HUA XUAN YANG ELECTRONICS representative nearest you before using any HUA XUAN YANG ELECTRONICS products described or contained herein in such applications.
- HUA XUAN YANG ELECTRONICS assumes no responsibility for equipment failures that result from using products at values that exceed, even momentarily, rated values (such as maximum ratings, operating condition ranges, or other parameters) listed in products specifications of any and all HUA XUAN YANG ELECTRONICS products described or contained herein.
- Specifications of any and all HUA XUAN YANG ELECTRONICS products described or contained herein stipulate the performance, characteristics, and functions of the described products in the independent state, and are not guarantees of the performance, characteristics, and functions of the described products as mounted in the customer's products or equipment. To verify symptoms and states that cannot be evaluated in an independent device, the customer should always evaluate and test devices mounted in the customer's products or equipment.
- HUA XUAN YANG ELECTRONICS CO.,LTD. strives to supply high-quality high-reliability products. However, any and all semiconductor products fail with some probability. It is possible that these probabilistic failures could give rise to accidents or events that could endanger human lives, that could give rise to smoke or fire, or that could cause damage to other property. When designing equipment, adopt safety measures so that these kinds of accidents or events cannot occur. Such measures include but are not limited to protective circuits and error prevention circuits for safe design, redundant design, and structural design.
- In the event that any or all HUA XUAN YANG ELECTRONICS products(including technical data, services) described or contained herein are controlled under any of applicable local export control laws and regulations, such products must not be exported without obtaining the export license from the authorities concerned in accordance with the above law.
- No part of this publication may be reproduced or transmitted in any form or by any means, electronic or mechanical, including photocopying and recording, or any information storage or retrieval system, or otherwise, without the prior written permission of HUA XUAN YANG ELECTRONICS CO.,LTD.
- Information (including circuit diagrams and circuit parameters) herein is for example only ; it is not guaranteed for volume production. HUA XUAN YANG ELECTRONICS believes information herein is accurate and reliable, but no guarantees are made or implied regarding its use or any infringements of intellectual property rights or other rights of third parties.
- Any and all information described or contained herein are subject to change without notice due to product/technology improvement, etc. When designing equipment, refer to the "Delivery Specification" for the HUA XUAN YANG ELECTRONICS product that you intend to use.