

INSTRUCTION MANUAL

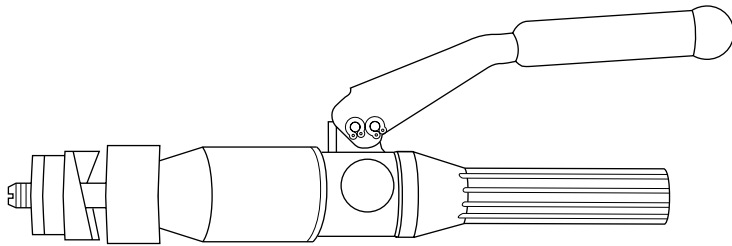

7804SB / 7806SB
Quick Draw®

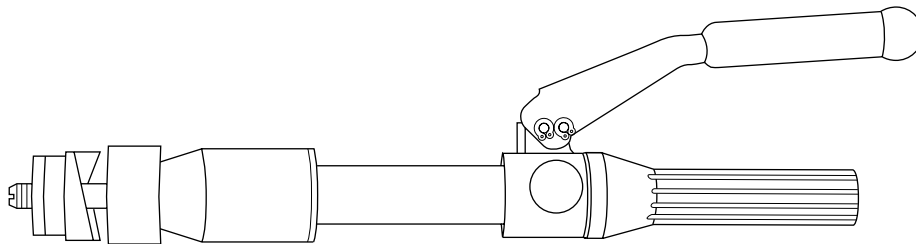

7704SB / 7706SB
Quick Draw Flex™

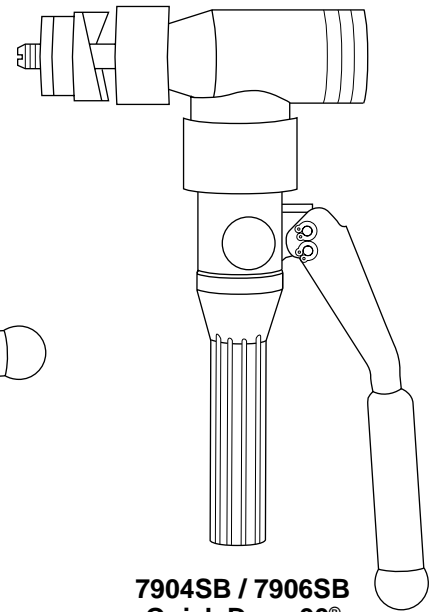

7904SB / 7906SB
Quick Draw 90®

Quick Draw® Hydraulic Punch Drivers

Serial Codes AHJ, YZ, and ZA



Read and understand all of the instructions and safety information in this manual before operating or servicing this tool.

Table of Contents

Description	2
Safety	2
Purpose of this Manual	2
Other Publications	2
Important Safety Information	3–4
Specifications	5
Capacity and Draw Stud Selection Guide	6
Operation	7
Maintenance	8
Troubleshooting	9
Draw Studs and Accessories	10

Description

The Quick Draw® punch drivers are self-contained hydraulic tools.

These punch drivers, when used with Greenlee punches, dies, and draw studs, form a complete system for punching holes of various shapes and sizes through mild steel, aluminum, fiberglass, and plastic.

Slug-Splitter® punches, dies, and studs are available for punching all of these materials as well as stainless steel.

In addition, the 7704SB / 7706SB punch driver has a flexible body that allows hole punching at a variety of angles. The handle and release mechanisms rotate nearly 360° for convenient actuation.

Safety

Safety is essential in the use and maintenance of Greenlee tools and equipment. This manual and any markings on the tool provide information for avoiding hazards and unsafe practices related to the use of this tool. Observe all of the safety information provided.

Purpose of this Manual

This manual is intended to familiarize all personnel with the safe operation and maintenance procedures for the following Greenlee hydraulic punch drivers:

7704SB / 7706SB Quick Draw Flex™

7804SB / 7806SB Quick Draw®

7904SB / 7906SB Quick Draw 90®

Keep this manual available to all personnel.

Replacement manuals are available upon request at no charge.

Other Publications

Service Manual:

7704SB / 7706SB: Publication 999 4732.3

7804SB / 7806SB: Publication 999 4732.3

7904SB / 7906SB: Publication 999 4731.5

All specifications are nominal and may change as design improvements occur. Greenlee Textron shall not be liable for damages resulting from misapplication or misuse of its products.

Quick Draw Flex is a trademark and Quick Draw, Quick Draw 90, Slug-Buster, and Slug-Splitter are registered trademarks of Greenlee Textron.

KEEP THIS MANUAL

IMPORTANT SAFETY INFORMATION



SAFETY ALERT SYMBOL

This symbol is used to call your attention to hazards or unsafe practices which could result in an injury or property damage. The signal word, defined below, indicates the severity of the hazard. The message after the signal word provides information for preventing or avoiding the hazard.

⚠ DANGER

Immediate hazards which, if not avoided, **WILL** result in severe injury or death.

⚠ WARNING

Hazards which, if not avoided, **COULD** result in severe injury or death.

⚠ CAUTION

Hazards or unsafe practices which, if not avoided, **MAY** result in injury or property damage.



⚠ WARNING

Electric shock hazard:

Do not use this tool near live circuits. This includes, but is not limited to, the following:

- Near circuit breaker panels or fuse boxes with energized circuits
- Near junction boxes with energized circuits

Failure to observe this warning can result in severe injury or death.

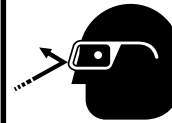

⚠ WARNING

Wear eye protection when operating or servicing this tool.

Failure to wear eye protection can result in serious eye injury from flying debris.

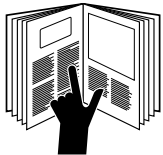

⚠ WARNING

Read and understand all of the instructions and safety information in this manual before operating or servicing this tool.

Failure to observe this warning can result in severe injury or death.

IMPORTANT SAFETY INFORMATION

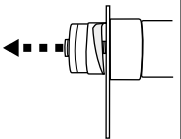
	<p>⚠ WARNING</p>
	<p>A component failure could throw broken parts.</p> <ul style="list-style-type: none"> • Do not allow anyone to stand in front of the punch or behind the hydraulic ram. • Close access doors or covers on any equipment that is in line with the punch or ram. <p>Failure to observe this warning can result in severe injury or death.</p>

<p>⚠ WARNING</p>
<ul style="list-style-type: none"> • Inspect tool for wear or damage. Replace any worn, damaged, or missing components with Greenlee replacement parts. A damaged or improperly assembled tool can break and strike nearby personnel with sufficient force to cause severe injury or death. • Inspect the punch, die, draw stud, and spacers for wear or damage. Replace any worn or damaged items with Greenlee replacement parts. Replace any punches that have dull cutting surfaces.

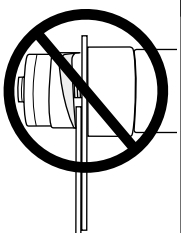
	<p>⚠ WARNING</p>
	<p>Do not attempt to punch a hole through two or more layers of material. This will bend or break the draw stud and could throw parts with great force.</p> <p>Failure to observe this warning can result in severe injury or death.</p>

<p>⚠ WARNING</p>
<p>Do not exceed the rated capacity of this tool. Exceeding the rated capacity could cause a component failure, which could throw broken parts with great force.</p> <p>Failure to observe this warning can result in severe injury or death.</p>

<p>⚠ WARNING</p>
<p>Set up the tool properly. An improper setup could cause a component to fail and strike nearby personnel with great force.</p> <ul style="list-style-type: none"> • Thread the punch completely onto the draw stud. All of the punch threads must be engaged by the draw stud threads. Incomplete assembly could cause a component failure. • Use only Greenlee punches, dies, and draw studs. Other manufacturers' components might not withstand the forces generated by this punch driver. <p>Failure to observe these warnings can result in severe injury or death.</p>

<p>⚠ WARNING</p>
<p>Do not operate the pump lever after the ram motion stops. Continuing to operate the pump lever after the ram motion stops will damage the driver and could propel internal parts with great force, striking nearby personnel.</p>

<p>⚠ CAUTION</p>
<p>Use this tool for the manufacturer's intended purpose only. Use other than that which is described in this manual can result in injury or property damage.</p>

Note: Keep all decals clean and legible, and replace when necessary.

Specifications

Application Information

Refer to “Capacity and Draw Stud Selection Guide.”

Dimensions—7704SB / 7706SB Quick Draw Flex

Length

Without Draw Stud	406 mm (16.00")
With 3/4" Draw Stud	482 mm (19.00")
Width (with handle extended)	260 mm (10.25")
Mass/Weight	2.60 kg (5.75 lb)

Dimensions—7804SB / 7806SB Quick Draw

Length

Without Draw Stud	321 mm (12.625")
With 3/4" Draw Stud	397 mm (15.625")
Width (with handle extended)	260 mm (10.25")
Mass/Weight	2.49 kg (5.5 lb)

Dimensions—7904SB / 7906SB Quick Draw 90

Overall Length	324 mm (12.75")
Mass/Weight	3.4 kg (7.4 lb)

Mechanical Data

Stroke (maximum)	22 mm (0.850") minimum draw stud travel
Handle Force (maximum)	356 N (80 lb)
Draw Stud Force (maximum)	71,168 N (16,000 lb)
Punch Diameter (maximum)	Refer to “Capacity and Draw Stud Selection Guide”
Material Thickness (maximum)	Refer to “Capacity and Draw Stud Selection Guide”

Hydraulic Data

Circuit Type	Closed
Operating Pressure (maximum)	44,480 N (10,000 lb)
Volume	
Stroke	0.034 cm ³ /mm (0.053 in ³ /in)
Usable	33.9 mm ³ (2.07 in ³)
Reservoir	38.0 mm ³ (2.32 in ³)
Total	57.4 mm ³ (3.50 in ³)
Seals	Nitrile, fluorocarbon, and Teflon backup rings
	<i>Fluid Compatibility: Compatible with hydraulic oils, water, oil emulsions, synthetic oils rated for use with nitrile (Buna N) and fluorocarbon (Viton) seal material.</i>
Recommended Fluid	Greenlee hydraulic oil

Miscellaneous

Operating Temperature	-12 °C to 43 °C (10 °F to 110 °F)
Operating Position	No restrictions

Capacity and Draw Stud Selection Guide



10 ga. (0.1345" [3.4 mm])
Mild Steel



10 ga. (0.1345" [3.4 mm])
Stainless Steel



16 ga. (0.0598" [1.5 mm])
Mild Steel and 1/8" Soft Aluminum

Draw Studs and Accessories	Standard and Slug-Buster® Punches							Slug-Splitter® Punches					Electronic Connector Punches RS-232, 229, 231, 234, 238	
	1/2" con. Ø 0.885" 15.2 mm	3/4" con. Ø 1.115" 28.3 mm	1-7/32"	1" con. Ø 1.362" 34.6 mm	1-1/4" con. Ø 1.701" 43.2 mm	1-1/2" con. Ø 1.951" 49.6 mm	2" con. Ø 2.416" 61.5 mm	1/2" con. Ø 0.885" 15.2 mm	3/4" con. Ø 1.115" 28.3 mm	1-7/32"	1" con. Ø 1.362" 34.6 mm	1-1/4" con. Ø 1.701" 43.2 mm		
<p>1614SS 3/8" Draw Stud 1924AA Spacer 33967 Adapter</p>	Hatched													
<p>1924AA Spacer 29451 7/16" Draw Stud</p>								Vertical Lines						
<p>1924AA Spacer 31872 3/4" Draw Stud</p>		Hatched						Vertical Lines						
<p>31872 3/4" Draw Stud</p>					Hatched									
<p>1924AA Spacer 33967 Adapter</p>														Solid Black

Operation

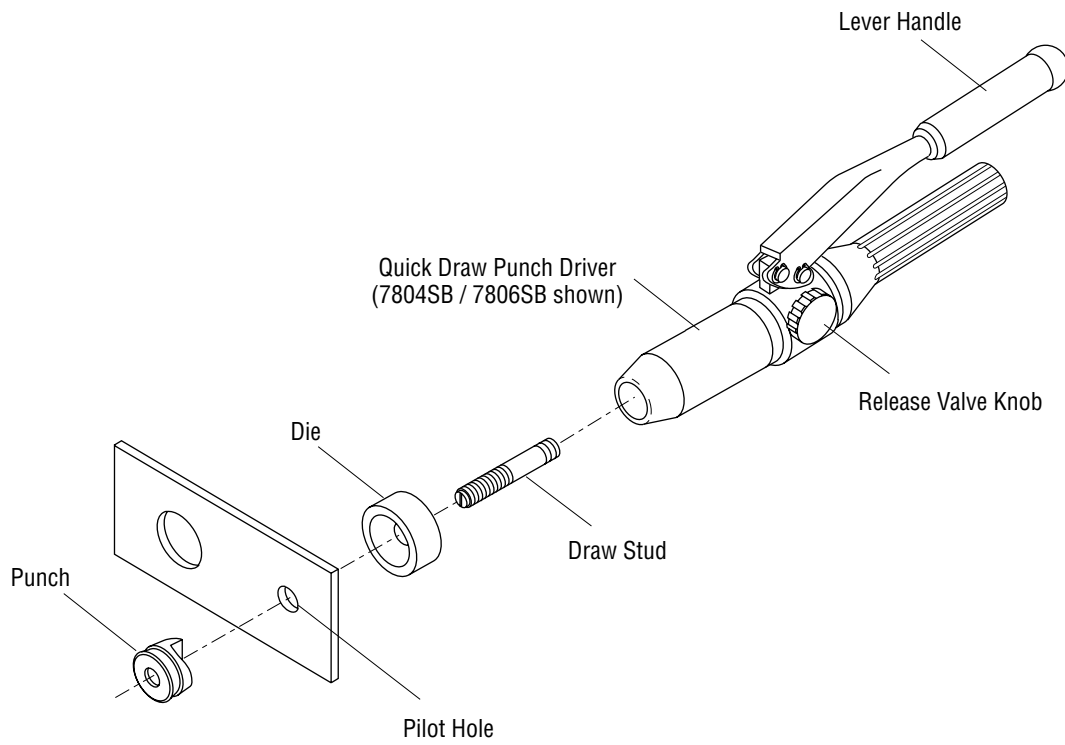

1. Drill a pilot hole.
2. Turn the release valve knob counterclockwise to fully extend the ram.
3. Assemble the appropriate die and draw stud components. Insert into the pilot hole.
4. Thread the punch onto the draw stud until it is tight. If the punch is not tight, the hole may not be completed.
5. Close the release valve knob. Pump the lever handle until the punch is completely through the material.
6. Open the release valve knob. Remove the punch.

Step-up Punching

The 1/2" conduit-size punch is often used to increase the size of the pilot hole; this is called "step-up punching." After enlarging the pilot hole, the 3/4" draw stud is used to punch the final hole.

⚠ WARNING

Do not operate the pump lever after the ram motion stops. Continuing to operate the pump lever after the ram motion stops will damage the driver and could propel internal parts with great force, striking nearby personnel.

Maintenance

Maintenance and repairs should be performed in a dust-free area by qualified technicians.

This unit requires minimum maintenance because it has a closed hydraulic system and all internal parts are lubricated by the hydraulic fluid. Lubricate lever pins lightly. Keep contaminants away from the ram and cylinder. Store with the lever down and hydraulic pressure released.

Adding Hydraulic Oil

1. Place the driver in a vise in a vertical position with the handles up. Unscrew the reservoir handle and remove the bladder plug. Open the release valve knob to assure the ram is fully extended.
2. Fill the rubber bladder to the point of overflow with Greenlee hydraulic oil.
3. Purge air from the system:

Pump the lever handle several times to remove air from the pumping chamber. Close the release valve knob and pump the lever handle until the ram completes its full travel. Repeat as necessary.

Note: Open the release valve knob slowly so the ram extends slowly. Rapid return of oil and air may cause the oil to overflow the rubber bladder.

If this procedure fails to remove air, remove the bladder plug and open the release valve knob. Place thumb over the plug hole in the bladder and squeeze the bladder while pumping the lever handle several times. Close the release valve knob and pump the lever handle until the ram completes its full travel. Repeat as necessary.

4. Fill the rubber bladder to the point of overflow and replace the bladder plug. Wipe the bladder clean of excess oil and reassemble the reservoir handle.

Oil Leaks

- Check for external oil leaks.
- Check that the release valve knob and stem are closed tightly and seating properly.
- Remove the reservoir handle and check for oil leaks around the rubber bladder and bladder plug.

Ram Section Will Not Rotate (7904SB / 7906SB Only)

1. Loosen and readjust the set screw.
2. Hold the punch driver with the ram section down.
3. Apply a small amount of penetrating oil to the cylinder at the attachment point, and then work the ram section back and forth.
4. Apply a small amount of SAE 30 oil to the cylinder collar next to the pump block.

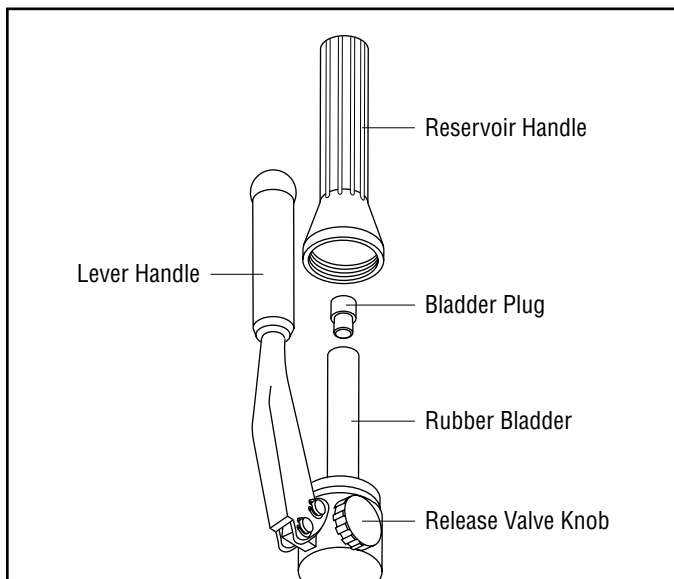

Troubleshooting

Problem	Probable Cause	Probable Remedy
Does not punch hole.	Improper assembly or use of punch, die, or accessories.	Refer to “Operation” and “Capacity and Draw Stud Selection Guide.”
	Low oil level.	Refer to “Adding Hydraulic Oil” in the “Maintenance” section.
Requires excessive lever force.	Improper assembly or use of punch, die, or accessories.	Refer to “Operation” and “Capacity and Draw Stud Selection Guide.”
	Material being punched is too thick or too hard.	Refer to “Capacity and Draw Stud Selection Guide.”
Pump does not build pressure.	Air in system.	Refer to step 3 of “Adding Hydraulic Oil” in the “Maintenance” section.

Draw Studs and Accessories

Cat. No.	Part No.	Description
29451	502 9451.2	Draw stud, 7/16" stainless steel
31872	503 1872.1	Draw stud, 3/4-16 x 4.12
1924AA	503 3248.8	Spacer, .767 x 1.37 x .875
1614SS	503 0043.1	Screw, 3/8" short adapter
33967	503 3967.2	Adapter, stud, 3/8-24 x 3/4-16