

## LM6171 High Speed Low Power Low Distortion Voltage Feedback Amplifier

Check for Samples: [LM6171](#)

### FEATURES

- (Typical Unless Otherwise Noted)
- Easy-To-Use Voltage Feedback Topology
- Very High Slew Rate: 3600V/ $\mu$ s
- Wide Unity-Gain-Bandwidth Product: 100 MHz
- -3dB Frequency @  $A_V = +2$ : 62 MHz
- Low Supply Current: 2.5 mA
- High CMRR: 110 dB
- High Open Loop Gain: 90 dB
- Specified for  $\pm 15$ V and  $\pm 5$ V Operation

### APPLICATIONS

- Multimedia Broadcast Systems
- Line Drivers, Switchers
- Video Amplifiers
- NTSC, PAL<sup>®</sup> and SECAM Systems
- ADC/DAC Buffers
- HDTV Amplifiers
- Pulse Amplifiers and Peak Detectors
- Instrumentation Amplifier
- Active Filters

### DESCRIPTION

The LM6171 is a high speed unity-gain stable voltage feedback amplifier. It offers a high slew rate of 3600V/ $\mu$ s and a unity-gain bandwidth of 100 MHz while consuming only 2.5 mA of supply current. The LM6171 has very impressive AC and DC performance which is a great benefit for high speed signal processing and video applications.

The  $\pm 15$ V power supplies allow for large signal swings and give greater dynamic range and signal-to-noise ratio. The LM6171 has high output current drive, low SFDR and THD, ideal for ADC/DAC systems. The LM6171 is specified for  $\pm 5$ V operation for portable applications.

The LM6171 is built on TI's advanced VIP III (Vertically Integrated PNP) complementary bipolar process.

### CONNECTION DIAGRAM

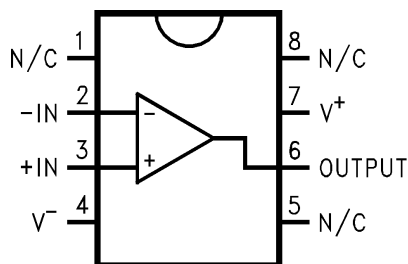

**Figure 1. Top View  
8-Pin SOIC/PDIP  
See Package Number D (SOIC) or  
See Package Number P (PDIP)**



These devices have limited built-in ESD protection. The leads should be shorted together or the device placed in conductive foam during storage or handling to prevent electrostatic damage to the MOS gates.



Please be aware that an important notice concerning availability, standard warranty, and use in critical applications of Texas Instruments semiconductor products and disclaimers thereto appears at the end of this data sheet.

PAL is a registered trademark of and used under license from Advanced Micro Devices, Inc..  
All other trademarks are the property of their respective owners.

### Absolute Maximum Ratings<sup>(1)(2)</sup>

ESD Tolerance <sup>(3)</sup>	2.5 kV	
Supply Voltage (V <sup>+</sup> –V <sup>–</sup> )	36V	
Differential Input Voltage	±10V	
Common-Mode Voltage Range	V <sup>+</sup> +0.3V to V <sup>–</sup> –0.3V	
Input Current	±10mA	
Output Short Circuit to Ground <sup>(4)</sup>	Continuous	
Storage Temperature Range	–65°C to +150°C	
Maximum Junction Temperature <sup>(5)</sup>	150°C	
Soldering Information	Infrared or Convection Reflow (20 sec.)	235°C
	Wave Soldering Lead Temp (10 sec.)	260°C

- (1) If Military/Aerospace specified devices are required, please contact the Texas Instruments Sales Office/Distributors for availability and specifications.
- (2) Absolute Maximum Ratings indicate limits beyond which damage to the device may occur. Operating Ratings indicate conditions for which the device is intended to be functional, but specific performance is not guaranteed. For guaranteed specifications and the test conditions, see the Electrical Characteristics.
- (3) Human body model, 1.5 kΩ in series with 100 pF.
- (4) Continuous short circuit operation at elevated ambient temperature can result in exceeding the maximum allowed junction temperature of 150°C.
- (5) The maximum power dissipation is a function of T<sub>J(max)</sub>, θ<sub>JA</sub>, and T<sub>A</sub>. The maximum allowable power dissipation at any ambient temperature is P<sub>D</sub> = (T<sub>J(max)</sub> – T<sub>A</sub>)/θ<sub>JA</sub>. All numbers apply for packages soldered directly into a PC board.

### Operating Ratings<sup>(1)</sup>

Supply Voltage	5.5V ≤ V <sub>S</sub> ≤ 34V	
Operating Temperature Range	LM6171AI, LM6171BI	–40°C to +85°C
Thermal Resistance (θ <sub>JA</sub> )	P Package, 8-Pin PDIP	108°C/W
	D Package, 8-Pin SOIC	172°C/W

- (1) Absolute Maximum Ratings indicate limits beyond which damage to the device may occur. Operating Ratings indicate conditions for which the device is intended to be functional, but specific performance is not guaranteed. For guaranteed specifications and the test conditions, see the Electrical Characteristics.

## ±15V DC Electrical Characteristics

Unless otherwise specified, all limits guaranteed for  $T_J = 25^\circ\text{C}$ ,  $V^+ = +15\text{V}$ ,  $V^- = -15\text{V}$ ,  $V_{\text{CM}} = 0\text{V}$ , and  $R_L = 1\text{ k}\Omega$ . **Boldface** limits apply at the temperature extremes

Symbol	Parameter	Conditions	Typ (1)	LM6171AI Limit (2)	LM6171BI Limit (2)	Units
$V_{\text{OS}}$	Input Offset Voltage		1.5	3 <b>5</b>	6 <b>8</b>	mV max
TC $V_{\text{OS}}$	Input Offset Voltage Average Drift		6			$\mu\text{V}/^\circ\text{C}$
$I_{\text{B}}$	Input Bias Current		1	3 <b>4</b>	3 <b>4</b>	$\mu\text{A}$ max
$I_{\text{OS}}$	Input Offset Current		0.03	2 <b>3</b>	2 <b>3</b>	$\mu\text{A}$ max
$R_{\text{IN}}$	Input Resistance	Common Mode	40			M $\Omega$
		Differential Mode	4.9			
$R_{\text{O}}$	Open Loop Output Resistance		14			$\Omega$
CMRR	Common Mode Rejection Ratio	$V_{\text{CM}} = \pm 10\text{V}$	110	80 <b>75</b>	75 <b>70</b>	dB min
PSRR	Power Supply Rejection Ratio	$V_{\text{S}} = \pm 15\text{V}$ to $\pm 5\text{V}$	95	85 <b>80</b>	80 <b>75</b>	dB min
$V_{\text{CM}}$	Input Common-Mode Voltage Range	CMRR $\geq 60\text{ dB}$	$\pm 13.5$			V
$A_{\text{V}}$	Large Signal Voltage Gain <sup>(3)</sup>	$R_L = 1\text{ k}\Omega$	90	80 <b>70</b>	80 <b>70</b>	dB min
		$R_L = 100\Omega$	83	70 <b>60</b>	70 <b>60</b>	dB min
$V_{\text{O}}$	Output Swing	$R_L = 1\text{ k}\Omega$	13.3	12.5 <b>12</b>	12.5 <b>12</b>	V min
			-13.3	-12.5 <b>-12</b>	-12.5 <b>-12</b>	V max
		$R_L = 100\Omega$	11.6	9 <b>8.5</b>	9 <b>8.5</b>	V min
			-10.5	-9 <b>-8.5</b>	-9 <b>-8.5</b>	V max
	Continuous Output Current (Open Loop) <sup>(4)</sup>	Sourcing, $R_L = 100\Omega$	116	90 <b>85</b>	90 <b>85</b>	mA min
		Sinking, $R_L = 100\Omega$	105	90 <b>85</b>	90 <b>85</b>	mA max
	Continuous Output Current (in Linear Region)	Sourcing, $R_L = 10\Omega$	100			mA
		Sinking, $R_L = 10\Omega$	80			mA
$I_{\text{SC}}$	Output Short Circuit Current	Sourcing	135			mA
		Sinking	135			mA
$I_{\text{S}}$	Supply Current		2.5	4 <b>4.5</b>	4 <b>4.5</b>	mA max

(1) Typical Values represent the most likely parametric norm.

(2) All limits are guaranteed by testing or statistical analysis.

(3) Large signal voltage gain is the total output swing divided by the input signal required to produce that swing. For  $V_{\text{S}} = \pm 15\text{V}$ ,  $V_{\text{OUT}} = \pm 5\text{V}$ . For  $V_{\text{S}} = +5\text{V}$ ,  $V_{\text{OUT}} = \pm 1\text{V}$ .

(4) The open loop output current is the output swing with the  $100\Omega$  load resistor divided by that resistor.

### ±15V AC Electrical Characteristics

Unless otherwise specified, all limits guaranteed for  $T_J = 25^\circ\text{C}$ ,  $V^+ = +15\text{V}$ ,  $V^- = -15\text{V}$ ,  $V_{\text{CM}} = 0\text{V}$ , and  $R_L = 1\text{ k}\Omega$ . **Boldface** limits apply at the temperature extremes

Symbol	Parameter	Conditions	Typ (1)	LM6171AI Limit (2)	LM6171BI Limit (2)	Units
SR	Slew Rate <sup>(3)</sup>	$A_V = +2$ , $V_{\text{IN}} = 13\text{ V}_{\text{PP}}$	3600			V/ $\mu\text{s}$
		$A_V = +2$ , $V_{\text{IN}} = 10\text{ V}_{\text{PP}}$	3000			
GBW	Unity Gain-Bandwidth Product		100			MHz
	-3 dB Frequency	$A_V = +1$	160			MHz
		$A_V = +2$	62			MHz
$\phi_m$	Phase Margin		40			deg
$t_s$	Settling Time (0.1%)	$A_V = -1$ , $V_{\text{OUT}} = \pm 5\text{V}$ $R_L = 500\Omega$	48			ns
	Propagation Delay	$V_{\text{IN}} = \pm 5\text{V}$ , $R_L = 500\Omega$ , $A_V = -2$	6			ns
$A_D$	Differential Gain <sup>(4)</sup>		0.03			%
$\phi_D$	Differential Phase <sup>(4)</sup>		0.5			deg
$e_n$	Input-Referred Voltage Noise	$f = 1\text{ kHz}$	12			nV/ $\sqrt{\text{Hz}}$
$i_n$	Input-Referred Current Noise	$f = 1\text{ kHz}$	1			pA/ $\sqrt{\text{Hz}}$

(1) Typical Values represent the most likely parametric norm.

(2) All limits are guaranteed by testing or statistical analysis.

(3) Slew rate is the average of the rising and falling slew rates.

(4) Differential gain and phase are measured with  $A_V = +2$ ,  $V_{\text{IN}} = 1\text{ V}_{\text{PP}}$  at 3.58 MHz and both input and output 75 $\Omega$  terminated.

## ±5V DC Electrical Characteristics

Unless otherwise specified, all limits guaranteed for  $T_J = 25^\circ\text{C}$ ,  $V^+ = +5\text{V}$ ,  $V^- = -5\text{V}$ ,  $V_{\text{CM}} = 0\text{V}$ , and  $R_L = 1\text{ k}\Omega$ . **Boldface** limits apply at the temperature extremes

Symbol	Parameter	Conditions	Typ (1)	LM6171AI Limit (2)	LM6171BI Limit (2)	Units
$V_{\text{OS}}$	Input Offset Voltage		1.2	3 <b>5</b>	6 <b>8</b>	mV max
TC $V_{\text{OS}}$	Input Offset Voltage Average Drift		4			$\mu\text{V}/^\circ\text{C}$
$I_{\text{B}}$	Input Bias Current		1	2.5 <b>3.5</b>	2.5 <b>3.5</b>	$\mu\text{A}$ max
$I_{\text{OS}}$	Input Offset Current		0.03	1.5 <b>2.2</b>	1.5 <b>2.2</b>	$\mu\text{A}$ max
$R_{\text{IN}}$	Input Resistance	Common Mode	40			M $\Omega$
		Differential Mode	4.9			
$R_{\text{O}}$	Open Loop Output Resistance		14			$\Omega$
CMRR	Common Mode Rejection Ratio	$V_{\text{CM}} = \pm 2.5\text{V}$	105	80 <b>75</b>	75 <b>70</b>	dB min
PSRR	Power Supply Rejection Ratio	$V_{\text{S}} = \pm 15\text{V}$ to $\pm 5\text{V}$	95	85 <b>80</b>	80 <b>75</b>	dB min
$V_{\text{CM}}$	Input Common-Mode Voltage Range	CMRR $\geq 60\text{ dB}$	$\pm 3.7$			V
$A_{\text{V}}$	Large Signal Voltage Gain <sup>(3)</sup>	$R_L = 1\text{ k}\Omega$	84	75 <b>65</b>	75 <b>65</b>	dB min
		$R_L = 100\Omega$	80	70 <b>60</b>	70 <b>60</b>	dB min
$V_{\text{O}}$	Output Swing	$R_L = 1\text{ k}\Omega$	3.5	3.2 <b>3</b>	3.2 <b>3</b>	V min
			-3.4	-3.2 <b>-3</b>	-3.2 <b>-3</b>	V max
		$R_L = 100\Omega$	3.2	2.8 <b>2.5</b>	2.8 <b>2.5</b>	V min
			-3.0	-2.8 <b>-2.5</b>	-2.8 <b>-2.5</b>	V max
	Continuous Output Current (Open Loop) <sup>(4)</sup>	Sourcing, $R_L = 100\Omega$	32	28 <b>25</b>	28 <b>25</b>	mA min
		Sinking, $R_L = 100\Omega$	30	28 <b>25</b>	28 <b>25</b>	mA max
$I_{\text{SC}}$	Output Short Circuit Current	Sourcing	130			mA
		Sinking	100			mA
$I_{\text{S}}$	Supply Current		2.3	3 <b>3.5</b>	3 <b>3.5</b>	mA max

(1) Typical Values represent the most likely parametric norm.

(2) All limits are guaranteed by testing or statistical analysis.

(3) Large signal voltage gain is the total output swing divided by the input signal required to produce that swing. For  $V_{\text{S}} = \pm 15\text{V}$ ,  $V_{\text{OUT}} = \pm 5\text{V}$ . For  $V_{\text{S}} = +5\text{V}$ ,  $V_{\text{OUT}} = \pm 1\text{V}$ .

(4) The open loop output current is the output swing with the  $100\Omega$  load resistor divided by that resistor.

## ±5V AC Electrical Characteristics

Unless otherwise specified, all limits guaranteed for  $T_J = 25^\circ\text{C}$ ,  $V^+ = +5\text{V}$ ,  $V^- = -5\text{V}$ ,  $V_{\text{CM}} = 0\text{V}$ , and  $R_L = 1\text{ k}\Omega$ . **Boldface** limits apply at the temperature extremes

Symbol	Parameter	Conditions	Typ (1)	LM6171AI Limit (2)	LM6171BI Limit (2)	Units
SR	Slew Rate <sup>(3)</sup>	$A_V = +2$ , $V_{\text{IN}} = 3.5\text{ V}_{\text{PP}}$	750			V/ $\mu\text{s}$
GBW	Unity Gain-Bandwidth Product		70			MHz
	-3 dB Frequency	$A_V = +1$	130			MHz
		$A_V = +2$	45			
$\phi_m$	Phase Margin		57			deg
$t_s$	Settling Time (0.1%)	$A_V = -1$ , $V_{\text{OUT}} = +1\text{V}$ , $R_L = 500\Omega$	60			ns
	Propagation Delay	$V_{\text{IN}} = \pm 1\text{V}$ , $R_L = 500\Omega$ , $A_V = -2$	8			ns
$A_D$	Differential Gain <sup>(4)</sup>		0.04			%
$\phi_D$	Differential Phase <sup>(4)</sup>		0.7			deg
$e_n$	Input-Referred Voltage Noise	$f = 1\text{ kHz}$	11			nV/ $\sqrt{\text{Hz}}$
$i_n$	Input-Referred Current Noise	$f = 1\text{ kHz}$	1			pA/ $\sqrt{\text{Hz}}$

- (1) Typical Values represent the most likely parametric norm.
- (2) All limits are guaranteed by testing or statistical analysis.
- (3) Slew rate is the average of the rising and falling slew rates.
- (4) Differential gain and phase are measured with  $A_V = +2$ ,  $V_{\text{IN}} = 1\text{ V}_{\text{PP}}$  at 3.58 MHz and both input and output 75 $\Omega$  terminated.

### Typical Performance Characteristics

Unless otherwise noted,  $T_A = 25^\circ\text{C}$

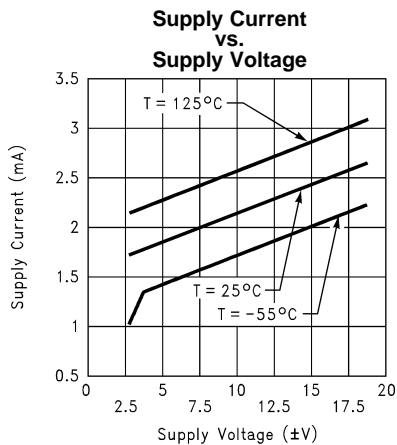

Figure 2.

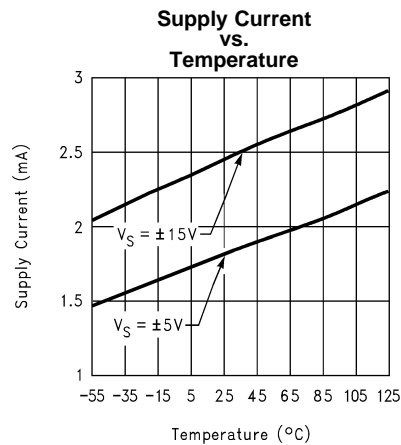

Figure 3.

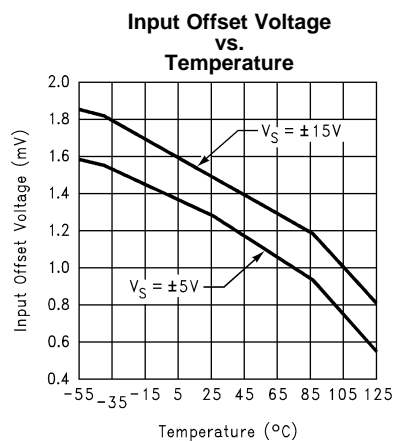

Figure 4.

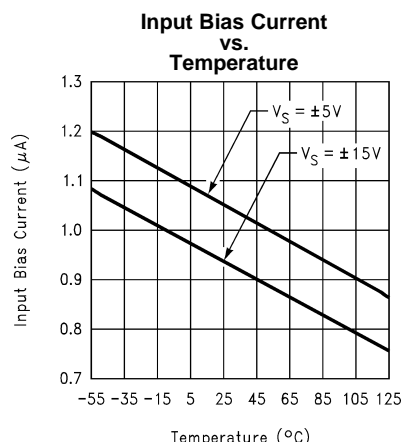

Figure 5.

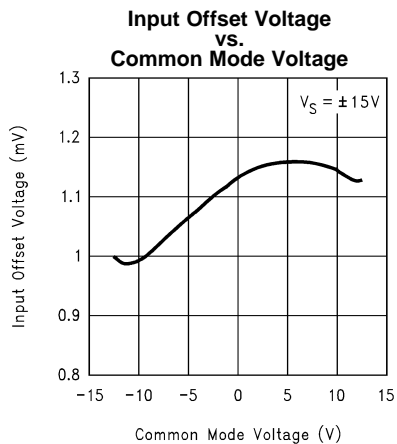

Figure 6.

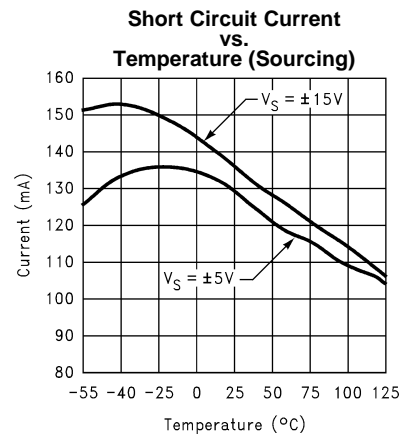
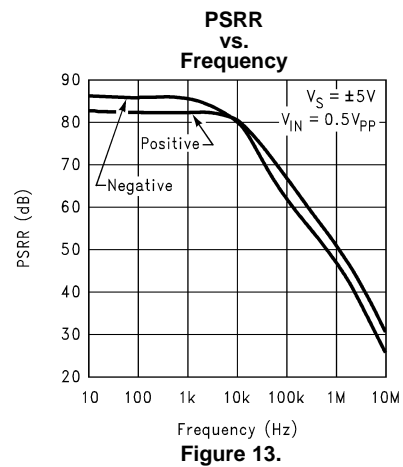
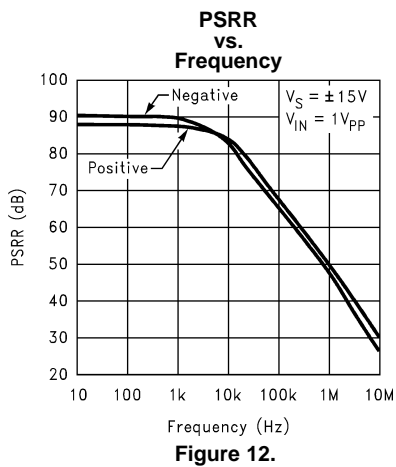
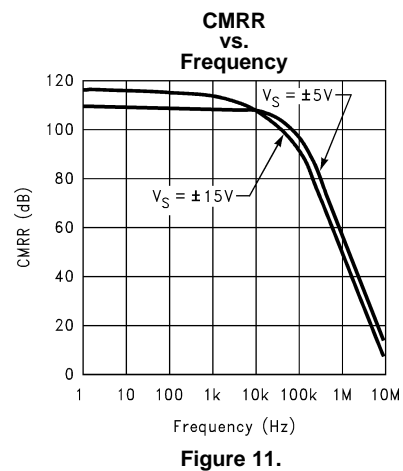
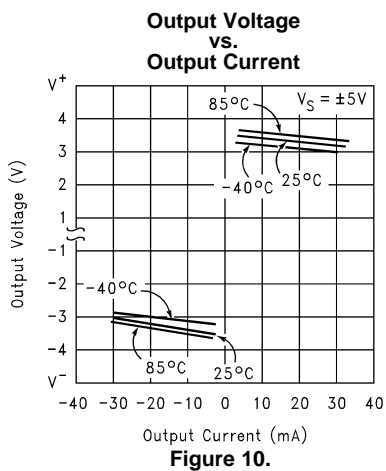
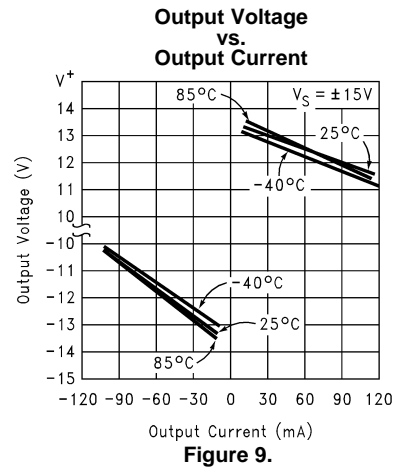
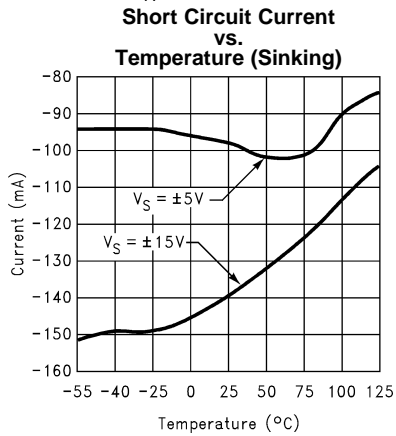

Figure 7.

**Typical Performance Characteristics (continued)**

Unless otherwise noted,  $T_A = 25^\circ\text{C}$





Typical Performance Characteristics (continued)

Unless otherwise noted,  $T_A = 25^\circ\text{C}$

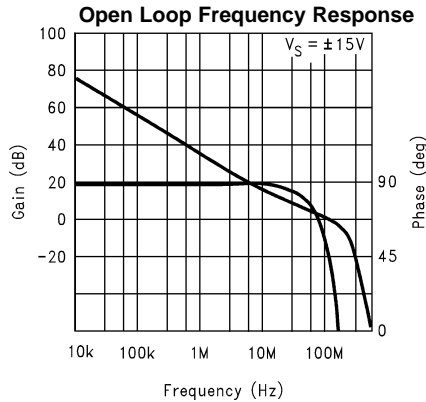

Figure 14.

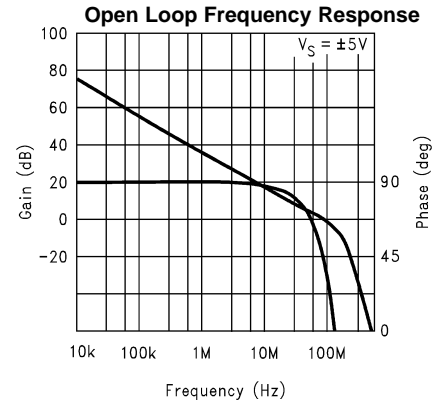

Figure 15.

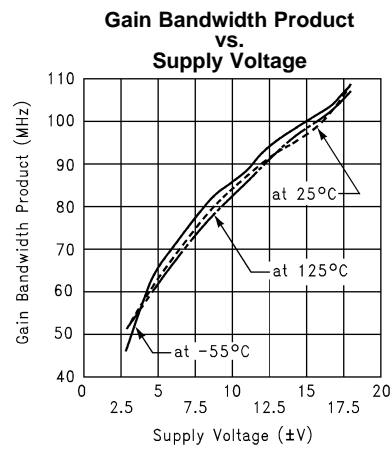

Figure 16.

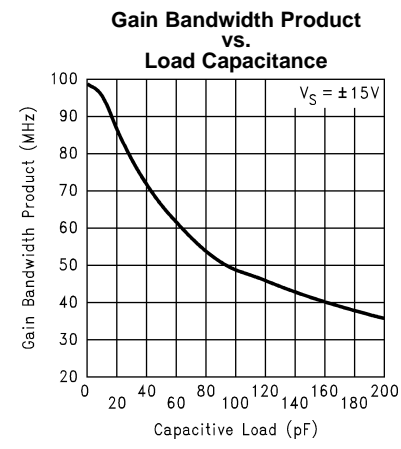

Figure 17.

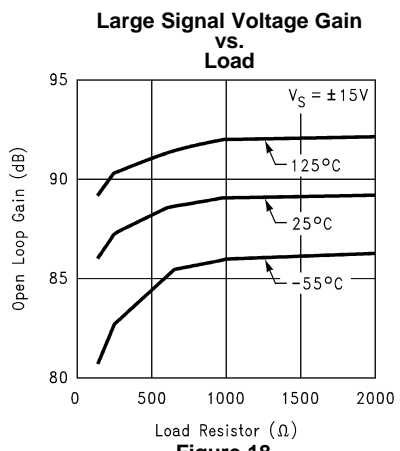

Figure 18.

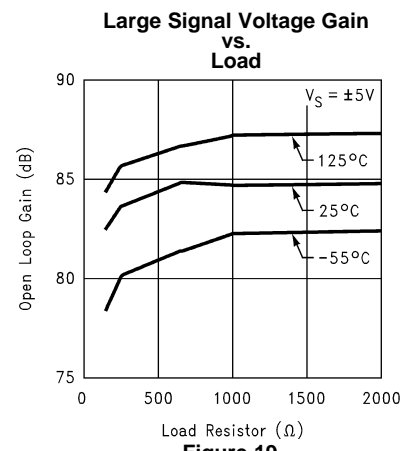
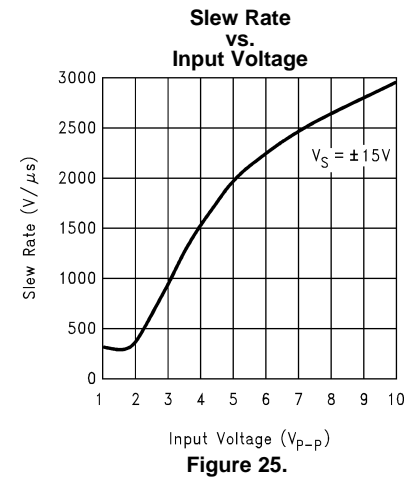
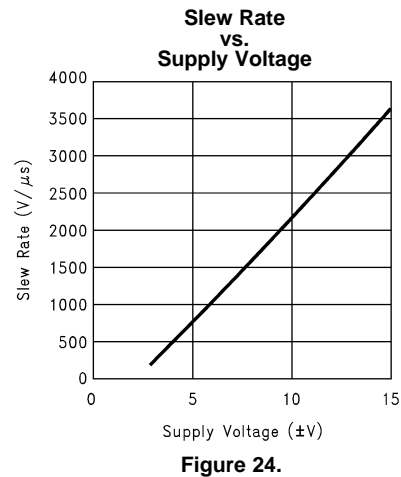
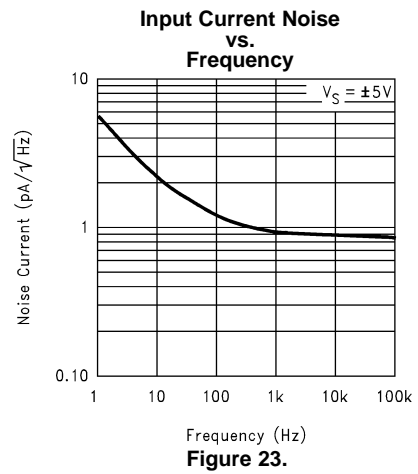
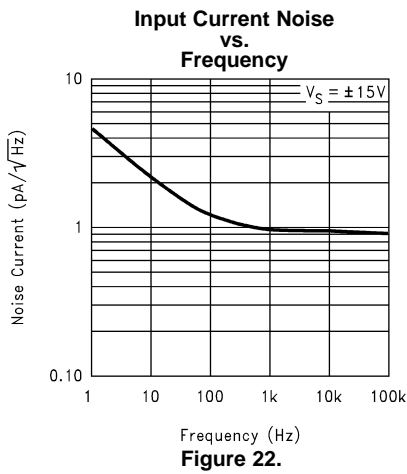
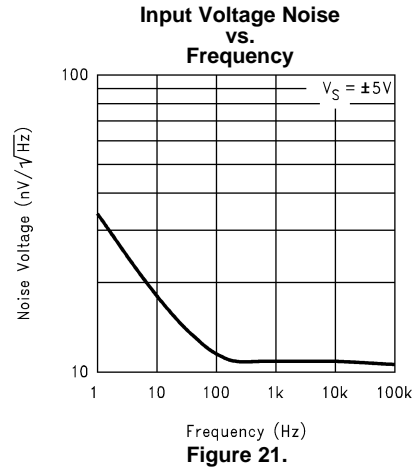
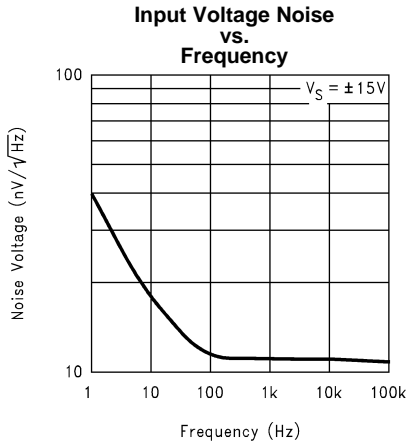

Figure 19.

**Typical Performance Characteristics (continued)**

Unless otherwise noted,  $T_A = 25^\circ\text{C}$



Typical Performance Characteristics (continued)

Unless otherwise noted,  $T_A = 25^\circ\text{C}$

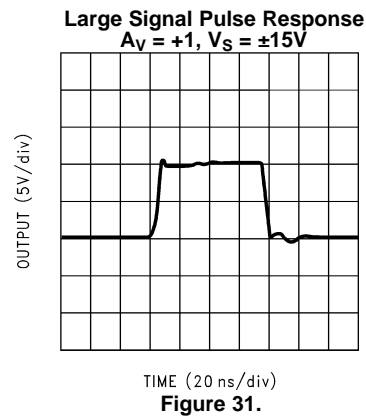
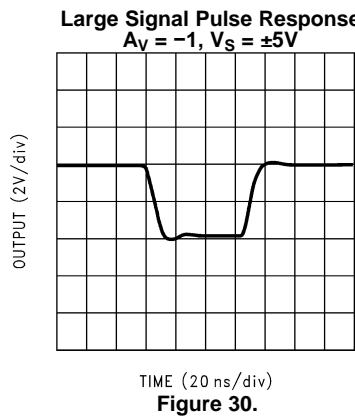
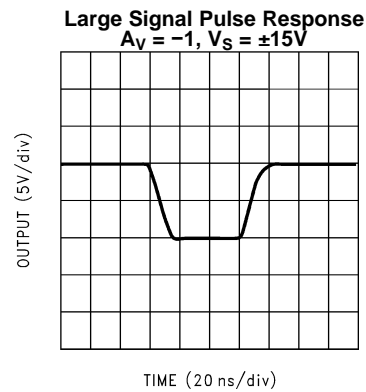
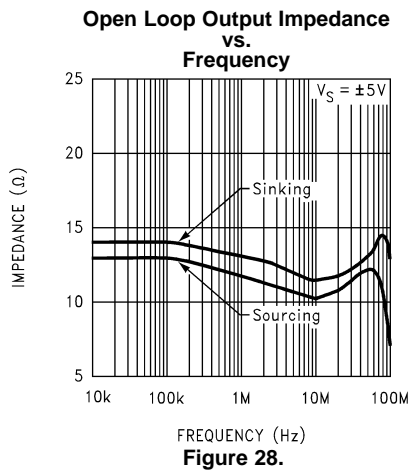
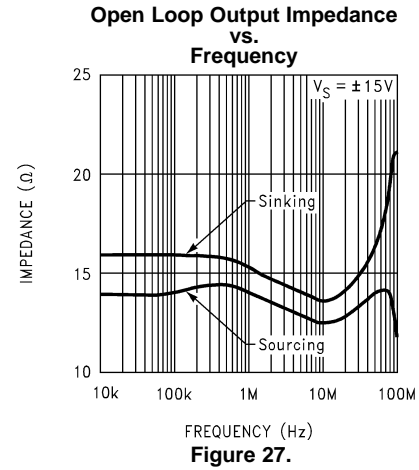
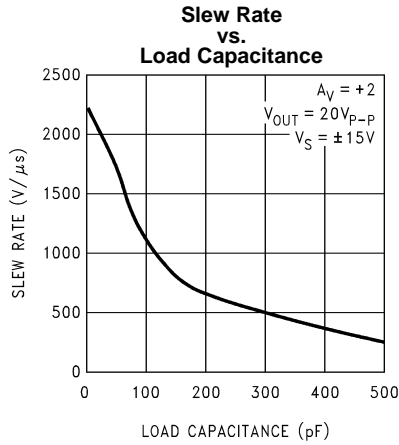

**Typical Performance Characteristics (continued)**

Unless otherwise noted,  $T_A = 25^\circ\text{C}$

**Large Signal Pulse Response**  
 $A_V = +1, V_S = \pm 5\text{V}$

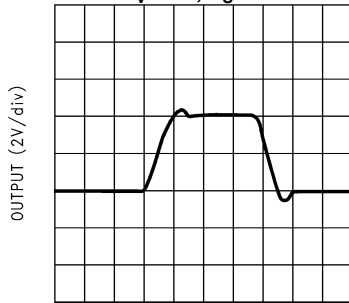

TIME (2 ns/div)  
**Figure 32.**

**Large Signal Pulse Response**  
 $A_V = +2, V_S = \pm 15\text{V}$

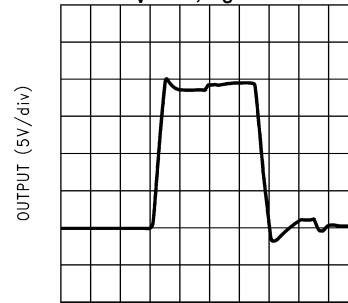

TIME (20 ns/div)  
**Figure 33.**

**Large Signal Pulse Response**  
 $A_V = +2, V_S = \pm 5\text{V}$

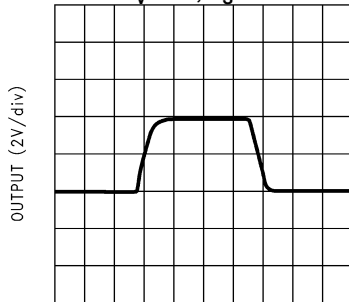

TIME (20 ns/div)  
**Figure 34.**

**Small Signal Pulse Response**  
 $A_V = -1, V_S = \pm 15\text{V}$

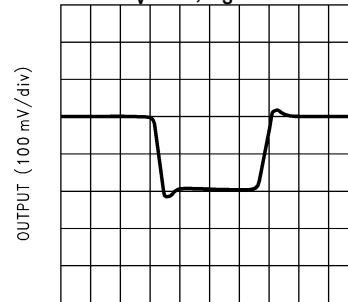

TIME (20 ns/div)  
**Figure 35.**

**Small Signal Pulse Response**  
 $A_V = -1, V_S = \pm 5\text{V}$

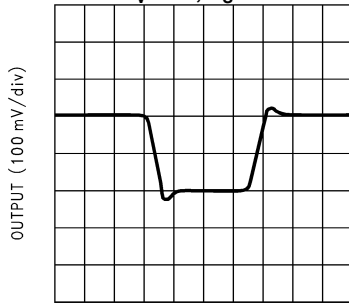

TIME (20 ns/div)  
**Figure 36.**

**Small Signal Pulse Response**  
 $A_V = +1, V_S = \pm 15\text{V}$

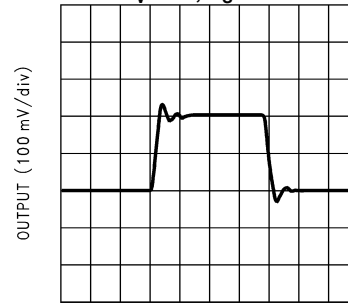

TIME (20 ns/div)  
**Figure 37.**

Typical Performance Characteristics (continued)

Unless otherwise noted,  $T_A = 25^\circ\text{C}$

Small Signal Pulse Response  
 $A_V = +1, V_S = \pm 5\text{V}$

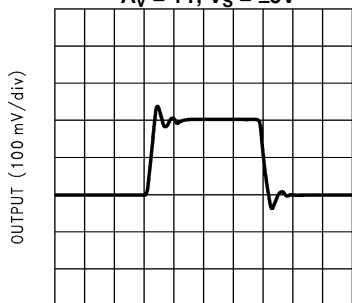

TIME (20 ns/div)  
Figure 38.

Small Signal Pulse Response  
 $A_V = +2, V_S = \pm 15\text{V}$

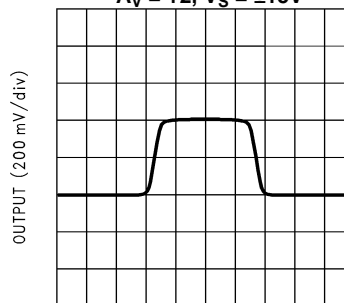

TIME (20 ns/div)  
Figure 39.

Small Signal Pulse Response  
 $A_V = +2, V_S = \pm 5\text{V}$

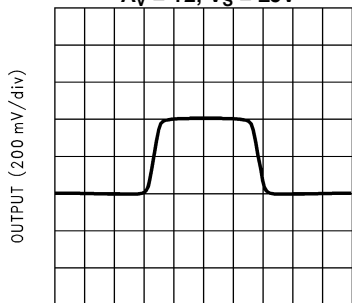
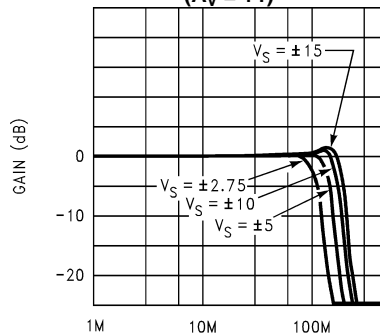

Figure 40.

Closed Loop Frequency Response  
vs.  
Supply Voltage  
( $A_V = +1$ )



FREQUENCY (Hz)  
Figure 41.

Closed Loop Frequency Response  
vs.  
Supply Voltage  
( $A_V = +2$ )

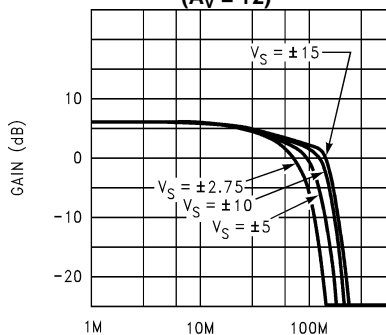

FREQUENCY (Hz)  
Figure 42.

Closed Loop Frequency Response  
vs.  
Capacitive Load  
( $A_V = +1$ )

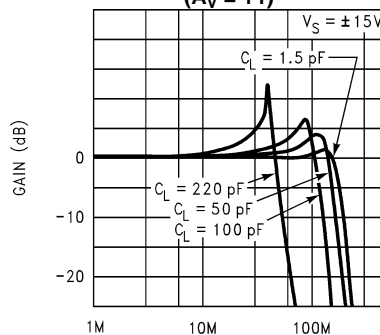

FREQUENCY (Hz)  
Figure 43.

**Typical Performance Characteristics (continued)**

Unless otherwise noted,  $T_A = 25^\circ\text{C}$

**Closed Loop Frequency Response vs. Capacitive Load ( $A_V = +1$ )**

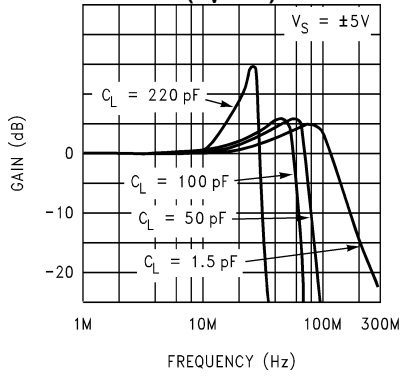

**Figure 44.**

**Closed Loop Frequency Response vs. Capacitive Load ( $A_V = +2$ )**

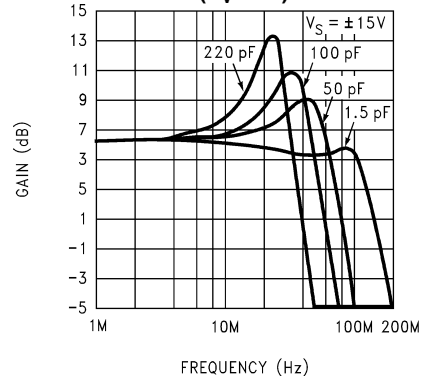

**Figure 45.**

**Closed Loop Frequency Response vs. Capacitive Load ( $A_V = +2$ )**

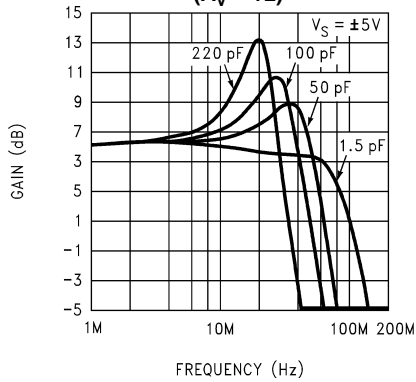

**Figure 46.**

**Total Harmonic Distortion vs. Frequency**

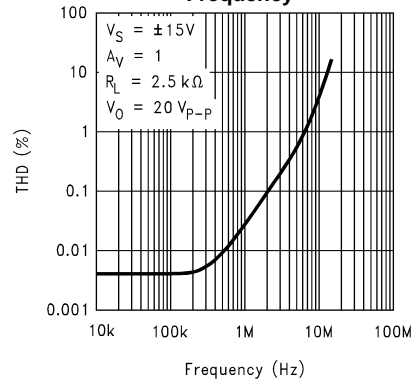

**Figure 47.**

**Total Harmonic Distortion vs. Frequency**

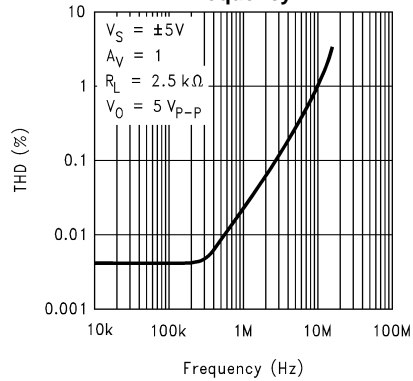

**Figure 48.**

**Total Harmonic Distortion vs. Frequency**

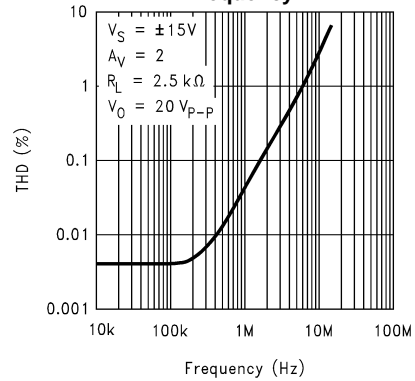

**Figure 49.**

Typical Performance Characteristics (continued)

Unless otherwise noted,  $T_A = 25^\circ\text{C}$

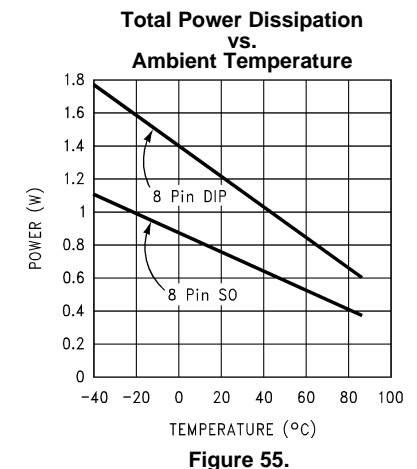
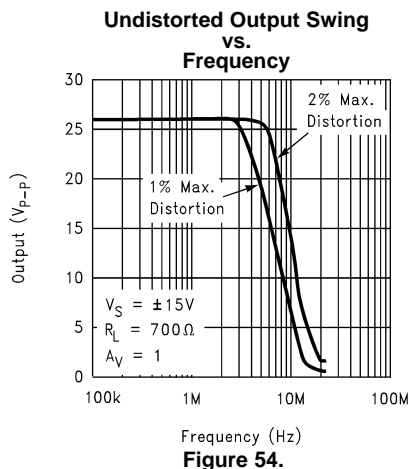
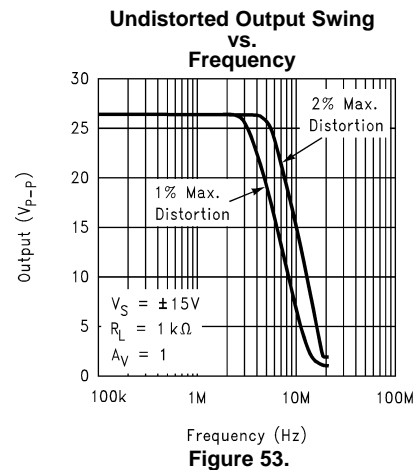
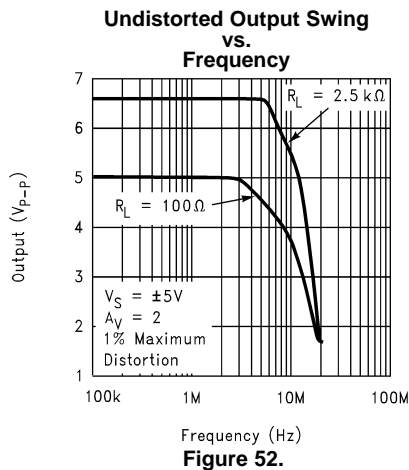
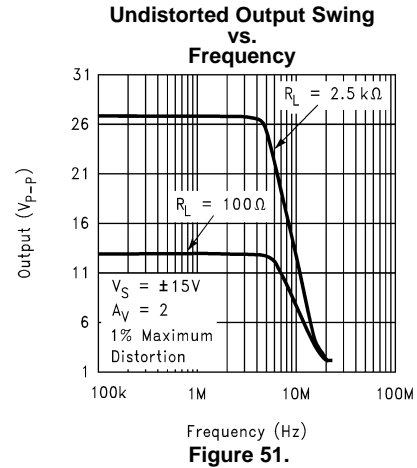
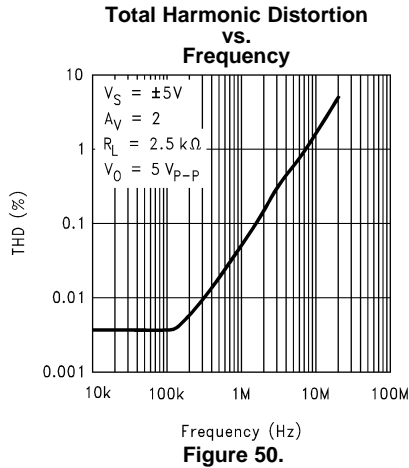

## LM6171 SIMPLIFIED SCHEMATIC

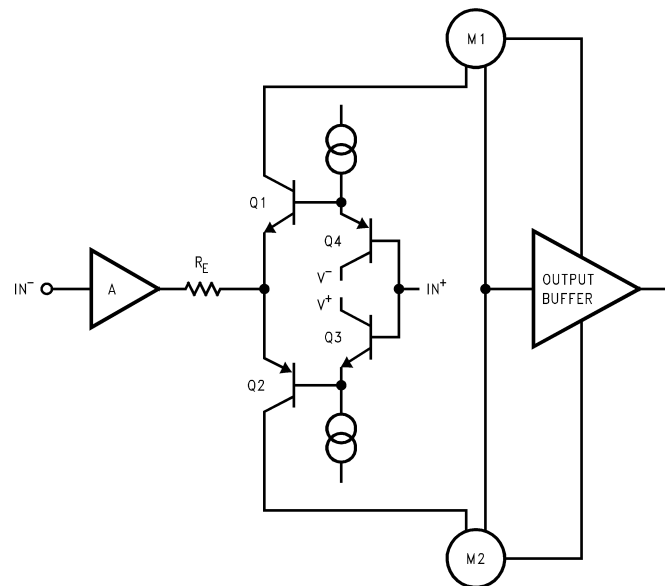

Figure 56.



## APPLICATION INFORMATION

### LM6171 PERFORMANCE DISCUSSION

The LM6171 is a high speed, unity-gain stable voltage feedback amplifier. It consumes only 2.5 mA supply current while providing a gain-bandwidth product of 100 MHz and a slew rate of 3600V/ $\mu$ s. It also has other great features such as low differential gain and phase and high output current. The LM6171 is a good choice in high speed circuits.

The LM6171 is a true voltage feedback amplifier. Unlike current feedback amplifiers (CFAs) with a low inverting input impedance and a high non-inverting input impedance, both inputs of voltage feedback amplifiers (VFAs) have high impedance nodes. The low impedance inverting input in CFAs will couple with feedback capacitor and cause oscillation. As a result, CFAs cannot be used in traditional op amp circuits such as photodiode amplifiers, I-to-V converters and integrators.

### LM6171 CIRCUIT OPERATION

The class AB input stage in LM6171 is fully symmetrical and has a similar slewing characteristic to the current feedback amplifiers. In LM6171 [Figure 56](#), Q1 through Q4 form the equivalent of the current feedback input buffer,  $R_E$  the equivalent of the feedback resistor, and stage A buffers the inverting input. The triple-buffered output stage isolates the gain stage from the load to provide low output impedance.

### LM6171 SLEW RATE CHARACTERISTIC

The slew rate of LM6171 is determined by the current available to charge and discharge an internal high impedance node capacitor. The current is the differential input voltage divided by the total degeneration resistor  $R_E$ . Therefore, the slew rate is proportional to the input voltage level, and the higher slew rates are achievable in the lower gain configurations.

When a very fast large signal pulse is applied to the input of an amplifier, some overshoot or undershoot occurs. By placing an external series resistor such as 1 k $\Omega$  to the input of LM6171, the bandwidth is reduced to help lower the overshoot.

## LAYOUT CONSIDERATION

### Printed Circuit Boards and High Speed Op Amps

There are many things to consider when designing PC boards for high speed op amps. Without proper caution, it is very easy and frustrating to have excessive ringing, oscillation and other degraded AC performance in high speed circuits. As a rule, the signal traces should be short and wide to provide low inductance and low impedance paths. Any unused board space needs to be grounded to reduce stray signal pickup. Critical components should also be grounded at a common point to eliminate voltage drop. Sockets add capacitance to the board and can affect frequency performance. It is better to solder the amplifier directly into the PC board without using any socket.

### Using Probes

Active (FET) probes are ideal for taking high frequency measurements because they have wide bandwidth, high input impedance and low input capacitance. However, the probe ground leads provide a long ground loop that will produce errors in measurement. Instead, the probes can be grounded directly by removing the ground leads and probe jackets and using scope probe jacks.

### Components Selection And Feedback Resistor

It is important in high speed applications to keep all component leads short because wires are inductive at high frequency. For discrete components, choose carbon composition-type resistors and mica-type capacitors. Surface mount components are preferred over discrete components for minimum inductive effect.

Large values of feedback resistors can couple with parasitic capacitance and cause undesirable effects such as ringing or oscillation in high speed amplifiers. For LM6171, a feedback resistor of 510 $\Omega$  gives optimal performance.

## COMPENSATION FOR INPUT CAPACITANCE

The combination of an amplifier's input capacitance with the gain setting resistors adds a pole that can cause peaking or oscillation. To solve this problem, a feedback capacitor with a value

$$C_F > (R_G \times C_{IN})/R_F \quad (1)$$

can be used to cancel that pole. For LM6171, a feedback capacitor of 2 pF is recommended. [Figure 57](#) illustrates the compensation circuit.

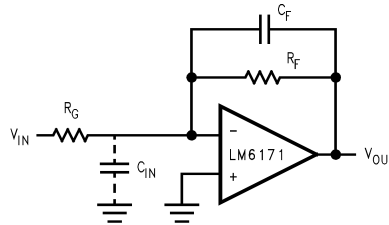

**Figure 57. Compensating for Input Capacitance**

## POWER SUPPLY BYPASSING

Bypassing the power supply is necessary to maintain low power supply impedance across frequency. Both positive and negative power supplies should be bypassed individually by placing 0.01  $\mu\text{F}$  ceramic capacitors directly to power supply pins and 2.2  $\mu\text{F}$  tantalum capacitors close to the power supply pins.

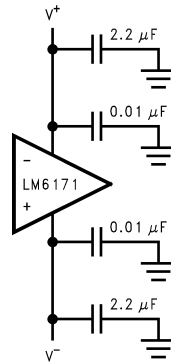

**Figure 58. Power Supply Bypassing**

## TERMINATION

In high frequency applications, reflections occur if signals are not properly terminated. [Figure 59](#) shows a properly terminated signal while [Figure 60](#) shows an improperly terminated signal.

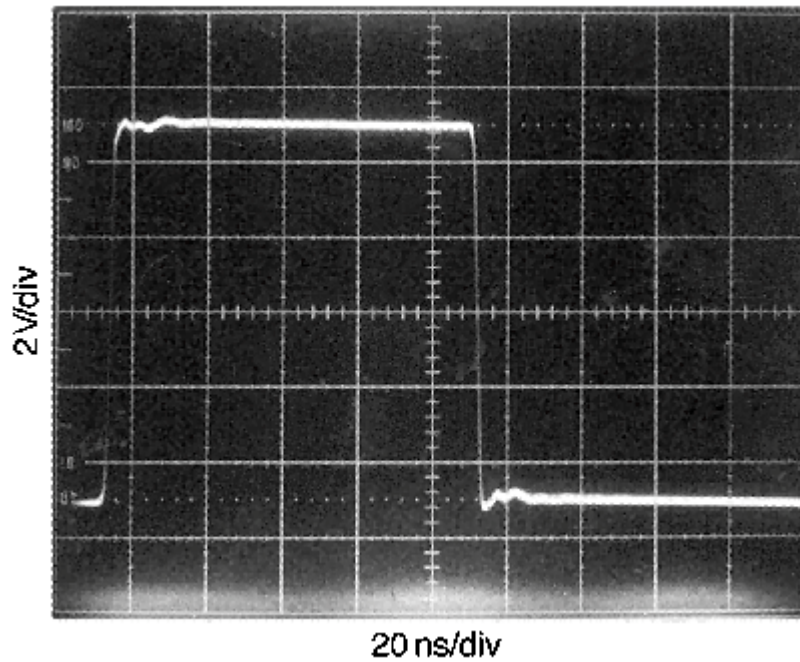

Figure 59. Properly Terminated Signal

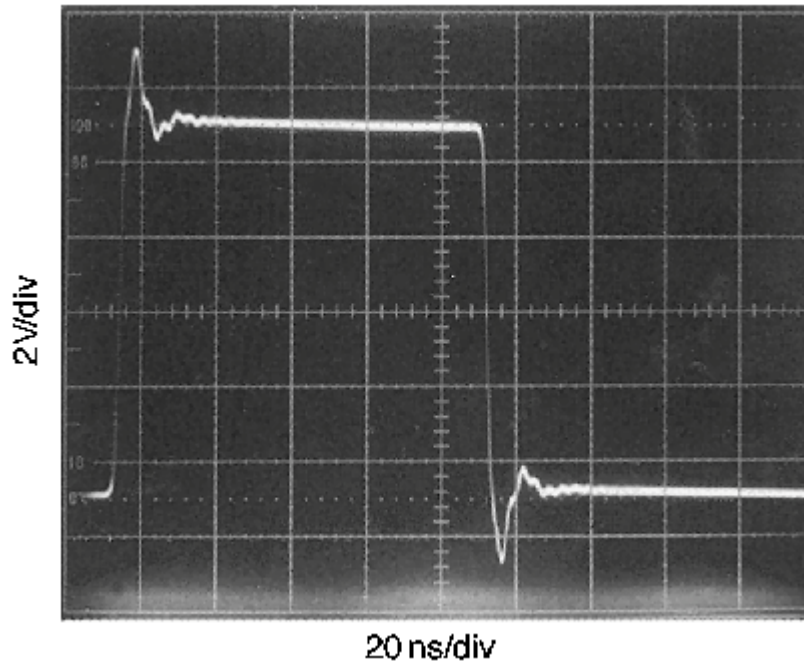

Figure 60. Improperly Terminated Signal

To minimize reflection, coaxial cable with matching characteristic impedance to the signal source should be used. The other end of the cable should be terminated with the same value terminator or resistor. For the commonly used cables, RG59 has 75 $\Omega$  characteristic impedance, and RG58 has 50 $\Omega$  characteristic impedance.

## DRIVING CAPACITIVE LOADS

Amplifiers driving capacitive loads can oscillate or have ringing at the output. To eliminate oscillation or reduce ringing, an isolation resistor can be placed as shown below in Figure 61. The combination of the isolation resistor and the load capacitor forms a pole to increase stability by adding more phase margin to the overall system. The desired performance depends on the value of the isolation resistor; the bigger the isolation resistor, the more damped the pulse response becomes. For LM6171, a 50Ω isolation resistor is recommended for initial evaluation. Figure 62 shows the LM6171 driving a 200 pF load with the 50Ω isolation resistor.

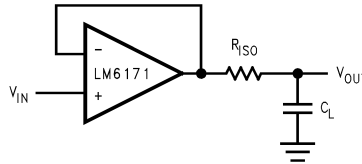

Figure 61. Isolation Resistor Used to Drive Capacitive Load

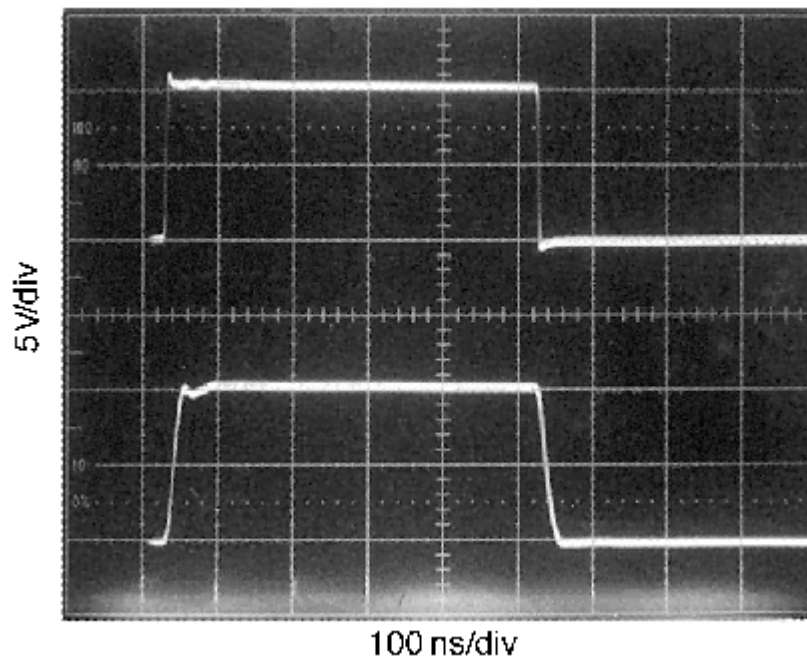

Figure 62. The LM6171 Driving a 200 pF Load with a 50Ω Isolation Resistor

## POWER DISSIPATION

The maximum power allowed to dissipate in a device is defined as:

$$P_D = (T_{J(max)} - T_A) / \theta_{JA}$$

where

- $P_D$  is the power dissipation in a device
- $T_{J(max)}$  is the maximum junction temperature
- $T_A$  is the ambient temperature
- $\theta_{JA}$  is the thermal resistance of a particular package (2)

For example, for the LM6171 in a SOIC-8 package, the maximum power dissipation at 25°C ambient temperature is 730 mW.

Thermal resistance,  $\theta_{JA}$ , depends on parameters such as die size, package size and package material. The smaller the die size and package, the higher  $\theta_{JA}$  becomes. The 8-pin PDIP package has a lower thermal resistance (108°C/W) than that of 8-pin SOIC-8 (172°C/W). Therefore, for higher dissipation capability, use an 8-pin PDIP package.

The total power dissipated in a device can be calculated as:

$$P_D = P_Q + P_L \quad (3)$$

$P_Q$  is the quiescent power dissipated in a device with no load connected at the output.  $P_L$  is the power dissipated in the device with a load connected at the output; it is not the power dissipated by the load.

Furthermore,

$$P_Q = \text{supply current} \times \text{total supply voltage with no load}$$

$$P_L = \text{output current} \times (\text{voltage difference between supply voltage and output voltage of the same supply})$$

For example, the total power dissipated by the LM6171 with  $V_S = \pm 15V$  and output voltage of 10V into 1 k $\Omega$  load resistor (one end tied to ground) is

$$\begin{aligned} P_D &= P_Q + P_L \\ &= (2.5 \text{ mA}) \times (30V) + (10 \text{ mA}) \times (15V - 10V) \\ &= 75 \text{ mW} + 50 \text{ mW} \\ &= 125 \text{ mW} \end{aligned}$$

## APPLICATION CIRCUITS

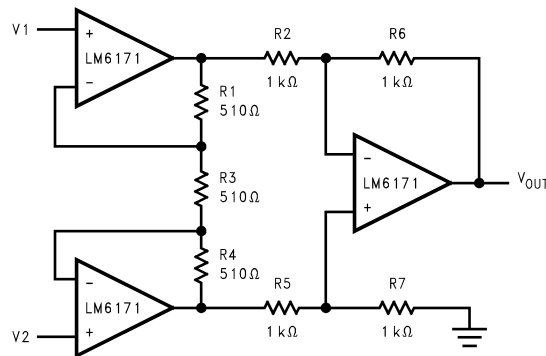

$$V_{IN} = V_2 - V_1$$

if  $R_6 = R_2$ ,  $R_7 = R_5$  and  $R_1 = R_4$

$$\frac{V_{OUT}}{V_{IN}} = \frac{R_6}{R_2} \left( 1 + 2 \frac{R_1}{R_3} \right) = 3$$

Figure 63. Fast Instrumentation Amplifier

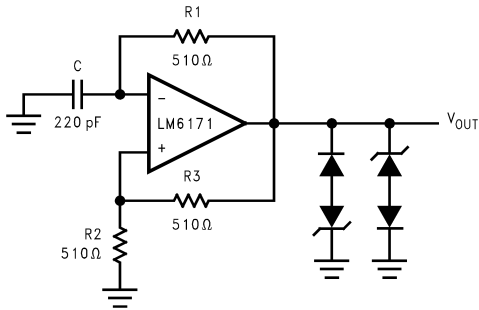

$$f = \frac{1}{2 \left( R_1 C \ln \left( 1 + 2 \frac{R_2}{R_3} \right) \right)}$$

$$f = 4 \text{ MHz}$$

**Figure 64. Multivibrator**

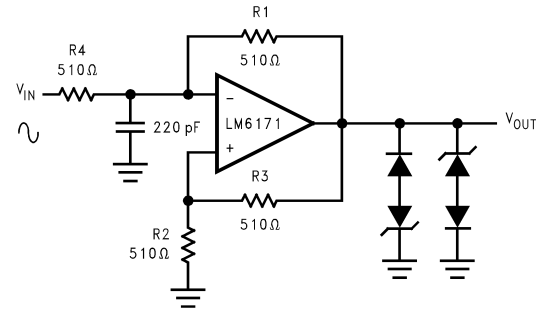

**Figure 65. Pulse Width Modulator**

---

**REVISION HISTORY**

<b>Changes from Revision B (March 2013) to Revision C</b>	<b>Page</b>
<hr/> <ul style="list-style-type: none"><li>• Changed layout of National Data Sheet to TI format .....</li></ul>	<hr/> <a href="#">21</a>

**PACKAGING INFORMATION**

Orderable Device	Status (1)	Package Type	Package Drawing	Pins	Package Qty	Eco Plan (2)	Lead/Ball Finish (6)	MSL Peak Temp (3)	Op Temp (°C)	Device Marking (4/5)	Samples
LM6171AIM	NRND	SOIC	D	8	95	TBD	Call TI	Call TI	-40 to 85	LM61 71AIM	
LM6171AIM/NOPB	ACTIVE	SOIC	D	8	95	Green (RoHS & no Sb/Br)	CU SN	Level-1-260C-UNLIM	-40 to 85	LM61 71AIM	<a href="#">Samples</a>
LM6171AIMX/NOPB	ACTIVE	SOIC	D	8	2500	Green (RoHS & no Sb/Br)	CU SN	Level-1-260C-UNLIM	-40 to 85	LM61 71AIM	<a href="#">Samples</a>
LM6171BIM	NRND	SOIC	D	8	95	TBD	Call TI	Call TI	-40 to 85	LM61 71BIM	
LM6171BIM/NOPB	ACTIVE	SOIC	D	8	95	Green (RoHS & no Sb/Br)	CU SN	Level-1-260C-UNLIM	-40 to 85	LM61 71BIM	<a href="#">Samples</a>
LM6171BIMX/NOPB	ACTIVE	SOIC	D	8	2500	Green (RoHS & no Sb/Br)	CU SN	Level-1-260C-UNLIM	-40 to 85	LM61 71BIM	<a href="#">Samples</a>
LM6171BIN/NOPB	ACTIVE	PDIP	P	8	40	Green (RoHS & no Sb/Br)	CU SN	Level-1-NA-UNLIM	-40 to 85	LM6171 BIN	<a href="#">Samples</a>

(1) The marketing status values are defined as follows:

**ACTIVE:** Product device recommended for new designs.

**LIFEBUY:** TI has announced that the device will be discontinued, and a lifetime-buy period is in effect.

**NRND:** Not recommended for new designs. Device is in production to support existing customers, but TI does not recommend using this part in a new design.

**PREVIEW:** Device has been announced but is not in production. Samples may or may not be available.

**OBSELETE:** TI has discontinued the production of the device.

(2) **RoHS:** TI defines "RoHS" to mean semiconductor products that are compliant with the current EU RoHS requirements for all 10 RoHS substances, including the requirement that RoHS substance do not exceed 0.1% by weight in homogeneous materials. Where designed to be soldered at high temperatures, "RoHS" products are suitable for use in specified lead-free processes. TI may reference these types of products as "Pb-Free".

**RoHS Exempt:** TI defines "RoHS Exempt" to mean products that contain lead but are compliant with EU RoHS pursuant to a specific EU RoHS exemption.

**Green:** TI defines "Green" to mean the content of Chlorine (Cl) and Bromine (Br) based flame retardants meet JS709B low halogen requirements of <=100ppm threshold. Antimony trioxide based flame retardants must also meet the <=1000ppm threshold requirement.

(3) MSL, Peak Temp. - The Moisture Sensitivity Level rating according to the JEDEC industry standard classifications, and peak solder temperature.

(4) There may be additional marking, which relates to the logo, the lot trace code information, or the environmental category on the device.

(5) Multiple Device Markings will be inside parentheses. Only one Device Marking contained in parentheses and separated by a "-" will appear on a device. If a line is indented then it is a continuation of the previous line and the two combined represent the entire Device Marking for that device.



<sup>(6)</sup> Lead/Ball Finish - Orderable Devices may have multiple material finish options. Finish options are separated by a vertical ruled line. Lead/Ball Finish values may wrap to two lines if the finish value exceeds the maximum column width.

**Important Information and Disclaimer:** The information provided on this page represents TI's knowledge and belief as of the date that it is provided. TI bases its knowledge and belief on information provided by third parties, and makes no representation or warranty as to the accuracy of such information. Efforts are underway to better integrate information from third parties. TI has taken and continues to take reasonable steps to provide representative and accurate information but may not have conducted destructive testing or chemical analysis on incoming materials and chemicals. TI and TI suppliers consider certain information to be proprietary, and thus CAS numbers and other limited information may not be available for release.

In no event shall TI's liability arising out of such information exceed the total purchase price of the TI part(s) at issue in this document sold by TI to Customer on an annual basis.

## TAPE AND REEL INFORMATION



### QUADRANT ASSIGNMENTS FOR PIN 1 ORIENTATION IN TAPE



\*All dimensions are nominal

Device	Package Type	Package Drawing	Pins	SPQ	Reel Diameter (mm)	Reel Width W1 (mm)	A0 (mm)	B0 (mm)	K0 (mm)	P1 (mm)	W (mm)	Pin1 Quadrant
LM6171AIMX/NOPB	SOIC	D	8	2500	330.0	12.4	6.5	5.4	2.0	8.0	12.0	Q1
LM6171BIMX/NOPB	SOIC	D	8	2500	330.0	12.4	6.5	5.4	2.0	8.0	12.0	Q1

**TAPE AND REEL BOX DIMENSIONS**

\*All dimensions are nominal

Device	Package Type	Package Drawing	Pins	SPQ	Length (mm)	Width (mm)	Height (mm)
LM6171AIMX/NOPB	SOIC	D	8	2500	367.0	367.0	35.0
LM6171BIMX/NOPB	SOIC	D	8	2500	367.0	367.0	35.0

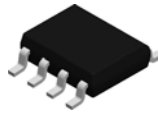

D0008A

# PACKAGE OUTLINE

SOIC - 1.75 mm max height

SMALL OUTLINE INTEGRATED CIRCUIT

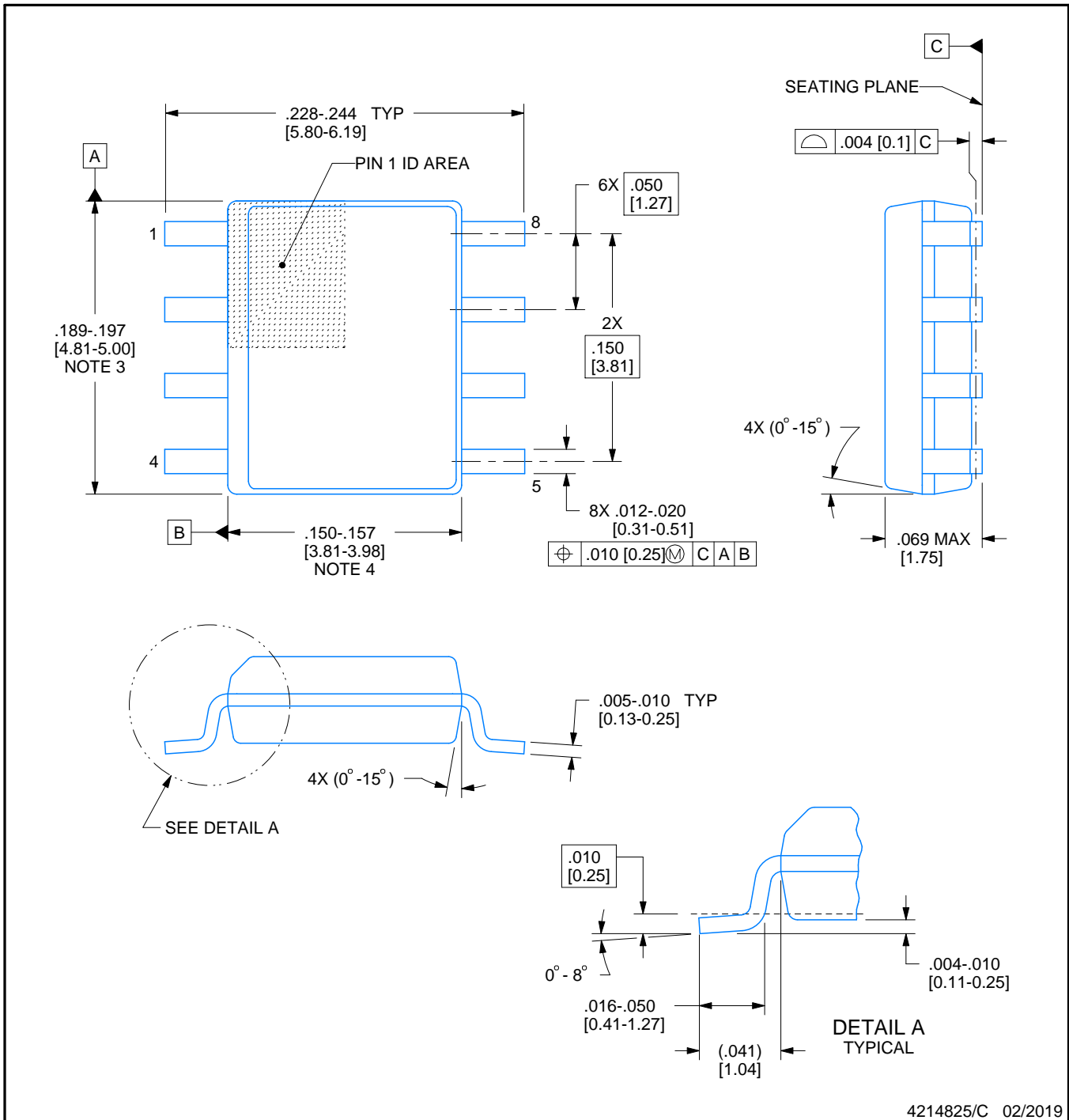

4214825/C 02/2019

NOTES:

1. Linear dimensions are in inches [millimeters]. Dimensions in parenthesis are for reference only. Controlling dimensions are in inches. Dimensioning and tolerancing per ASME Y14.5M.
2. This drawing is subject to change without notice.
3. This dimension does not include mold flash, protrusions, or gate burrs. Mold flash, protrusions, or gate burrs shall not exceed .006 [0.15] per side.
4. This dimension does not include interlead flash.
5. Reference JEDEC registration MS-012, variation AA.

# EXAMPLE BOARD LAYOUT

D0008A

SOIC - 1.75 mm max height

SMALL OUTLINE INTEGRATED CIRCUIT



LAND PATTERN EXAMPLE  
EXPOSED METAL SHOWN  
SCALE:8X



SOLDER MASK DETAILS

4214825/C 02/2019

NOTES: (continued)

- 6. Publication IPC-7351 may have alternate designs.
- 7. Solder mask tolerances between and around signal pads can vary based on board fabrication site.

# EXAMPLE STENCIL DESIGN

D0008A

SOIC - 1.75 mm max height

SMALL OUTLINE INTEGRATED CIRCUIT



SOLDER PASTE EXAMPLE  
BASED ON .005 INCH [0.125 MM] THICK STENCIL  
SCALE:8X

4214825/C 02/2019

NOTES: (continued)

8. Laser cutting apertures with trapezoidal walls and rounded corners may offer better paste release. IPC-7525 may have alternate design recommendations.
9. Board assembly site may have different recommendations for stencil design.

P (R-PDIP-T8)

PLASTIC DUAL-IN-LINE PACKAGE



- NOTES:
- A. All linear dimensions are in inches (millimeters).
  - B. This drawing is subject to change without notice.
  - C. Falls within JEDEC MS-001 variation BA.

## IMPORTANT NOTICE AND DISCLAIMER

TI PROVIDES TECHNICAL AND RELIABILITY DATA (INCLUDING DATASHEETS), DESIGN RESOURCES (INCLUDING REFERENCE DESIGNS), APPLICATION OR OTHER DESIGN ADVICE, WEB TOOLS, SAFETY INFORMATION, AND OTHER RESOURCES "AS IS" AND WITH ALL FAULTS, AND DISCLAIMS ALL WARRANTIES, EXPRESS AND IMPLIED, INCLUDING WITHOUT LIMITATION ANY IMPLIED WARRANTIES OF MERCHANTABILITY, FITNESS FOR A PARTICULAR PURPOSE OR NON-INFRINGEMENT OF THIRD PARTY INTELLECTUAL PROPERTY RIGHTS.

These resources are intended for skilled developers designing with TI products. You are solely responsible for (1) selecting the appropriate TI products for your application, (2) designing, validating and testing your application, and (3) ensuring your application meets applicable standards, and any other safety, security, or other requirements. These resources are subject to change without notice. TI grants you permission to use these resources only for development of an application that uses the TI products described in the resource. Other reproduction and display of these resources is prohibited. No license is granted to any other TI intellectual property right or to any third party intellectual property right. TI disclaims responsibility for, and you will fully indemnify TI and its representatives against, any claims, damages, costs, losses, and liabilities arising out of your use of these resources.

TI's products are provided subject to TI's Terms of Sale ([www.ti.com/legal/termsofsale.html](http://www.ti.com/legal/termsofsale.html)) or other applicable terms available either on [ti.com](http://ti.com) or provided in conjunction with such TI products. TI's provision of these resources does not expand or otherwise alter TI's applicable warranties or warranty disclaimers for TI products.

Mailing Address: Texas Instruments, Post Office Box 655303, Dallas, Texas 75265  
Copyright © 2019, Texas Instruments Incorporated