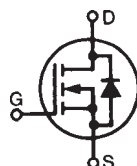


# Polar™ HiPerFET™ Power MOSFET

## IXFB300N10P

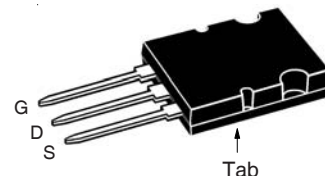
N-Channel Enhancement Mode  
Avalanche Rated  
Fast Intrinsic Diode



$$\begin{aligned} V_{DSS} &= 100V \\ I_{D25} &= 300A \\ R_{DS(on)} &\leq 5.5m\Omega \\ t_{rr} &\leq 200ns \end{aligned}$$

Symbol	Test Conditions	Maximum Ratings	
$V_{DSS}$	$T_J = 25^\circ C$ to $175^\circ C$	100	V
$V_{DGR}$	$T_J = 25^\circ C$ to $175^\circ C$ , $R_{GS} = 1M\Omega$	100	V
$V_{GSS}$	Continuous	$\pm 20$	V
$V_{GSM}$	Transient	$\pm 30$	V
$I_{D25}$	$T_C = 25^\circ C$	300	A
$I_{LRMS}$	Leads Current Limit, RMS	160	A
$I_{DM}$	$T_C = 25^\circ C$ , Pulse Width Limited by $T_{JM}$	900	A
$I_A$	$T_C = 25^\circ C$	100	A
$E_{AS}$	$T_C = 25^\circ C$	3	J
$dv/dt$	$I_S \leq I_{DM}$ , $V_{DD} \leq V_{DSS}$ , $T_J \leq 175^\circ C$	20	V/ns
$P_D$	$T_C = 25^\circ C$	1500	W
$T_J$		-55 ... +175	$^\circ C$
$T_{JM}$		175	$^\circ C$
$T_{stg}$		-55 ... +175	$^\circ C$
$T_L$	Maximum Lead Temperature for Soldering	300	$^\circ C$
$T_{SOLD}$	1.6 mm (0.062in.) from Case for 10s	260	$^\circ C$
$F_C$	Mounting Force	30..120/6.7..27	N/lb
<b>Weight</b>		10	g

### PLUS264™



G = Gate      D = Drain  
S = Source    Tab = Drain

### Features

- Low  $R_{DS(on)}$  and  $Q_G$
- Avalanche Rated
- Low Package Inductance
- Fast Intrinsic Diode

### Advantages

- High Power Density
- Easy to Mount
- Space Savings

### Applications

- DC-DC Converters
- Battery Chargers
- Switch-Mode and Resonant-Mode Power Supplies
- DC Choppers
- AC and DC Motor Drives
- Uninterrupted Power Supplies
- High Speed Power Switching Applications

Symbol	Test Conditions ( $T_J = 25^\circ C$ , Unless Otherwise Specified)	Characteristic Values		
		Min.	Typ.	Max.
$BV_{DSS}$	$V_{GS} = 0V$ , $I_D = 3mA$	100		V
$V_{GS(th)}$	$V_{DS} = V_{GS}$ , $I_D = 8mA$	2.5		5.0 V
$I_{GSS}$	$V_{GS} = \pm 20V$ , $V_{DS} = 0V$			$\pm 200$ nA
$I_{DSS}$	$V_{DS} = V_{DSS}$ , $V_{GS} = 0V$ $T_J = 150^\circ C$			25 $\mu A$ 1.5 mA
$R_{DS(on)}$	$V_{GS} = 10V$ , $I_D = 50A$ , Note 1			5.5 m $\Omega$

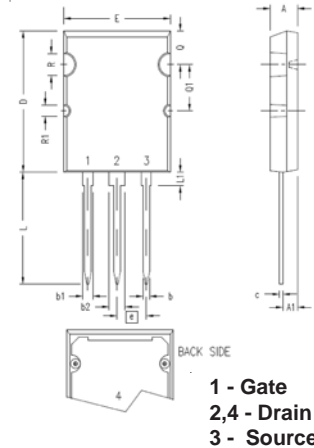
Symbol	Test Conditions ( $T_J = 25^\circ\text{C}$ , Unless Otherwise Specified)	Characteristic Values		
		Min.	Typ.	Max.
$g_{fs}$	$V_{DS} = 10\text{V}, I_D = 60\text{A}$ , Note 1	55	92	S
$C_{iss}$	$V_{GS} = 0\text{V}, V_{DS} = 25\text{V}, f = 1\text{MHz}$		23	nF
$C_{oss}$			6100	pF
$C_{rss}$			417	pF
$t_{d(on)}$	<b>Resistive Switching Times</b> $V_{GS} = 10\text{V}, V_{DS} = 0.5 \cdot V_{DSS}, I_D = 100\text{A}$ $R_G = 1\Omega$ (External)		36	ns
$t_r$			35	ns
$t_{d(off)}$			56	ns
$t_f$			25	ns
$Q_{g(on)}$	$V_{GS} = 10\text{V}, V_{DS} = 0.5 \cdot V_{DSS}, I_D = 0.5 \cdot I_{D25}$		279	nC
$Q_{gs}$			84	nC
$Q_{gd}$			107	nC
$R_{thJC}$			0.10	$^\circ\text{C/W}$
$R_{thCS}$		0.13		$^\circ\text{C/W}$

### Source-Drain Diode

Symbol	Test Conditions ( $T_J = 25^\circ\text{C}$ , Unless Otherwise Specified)	Characteristic Values		
		Min.	Typ.	Max.
$I_S$	$V_{GS} = 0\text{V}$			300 A
$I_{SM}$	Repetitive, Pulse Width Limited by $T_{JM}$			1000 A
$V_{SD}$	$I_F = 100\text{A}, V_{GS} = 0\text{V}$ , Note 1			1.3 V
$t_{rr}$	$I_F = 150\text{A}, -di/dt = 100\text{A}/\mu\text{s}$ $V_R = 50\text{V}$		0.71	200 ns
$Q_{RM}$				$\mu\text{C}$
$I_{RM}$			10	A

Note 1: Pulse test,  $t \leq 300\mu\text{s}$ , duty cycle,  $d \leq 2\%$ .

### PLUS264™ (IXFB) Outline

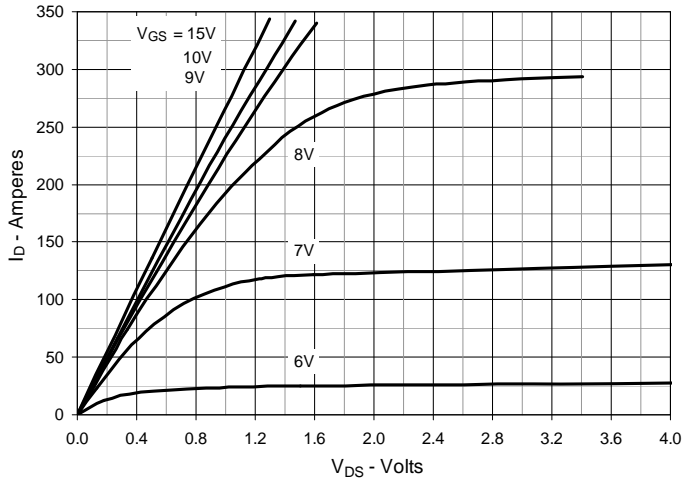


SYM	INCHES		MILLIMETERS	
	MIN	MAX	MIN	MAX
A	.185	.209	4.70	5.31
A1	.102	.118	2.59	3.00
b	.037	.055	0.94	1.40
b1	.087	.102	2.21	2.59
b2	.110	.126	2.79	3.20
c	.017	.029	0.43	0.74
D	1.007	1.047	25.58	26.59
E	.760	.799	19.30	20.29
e	.215 BSC		5.46 BSC	
L	.779	.842	19.79	21.39
L1	.087	.102	2.21	2.59
Q	.240	.256	6.10	6.50
Q1	.330	.346	8.38	8.79
ØR	.155	.187	3.94	4.75
ØR1	.085	.093	2.16	2.36

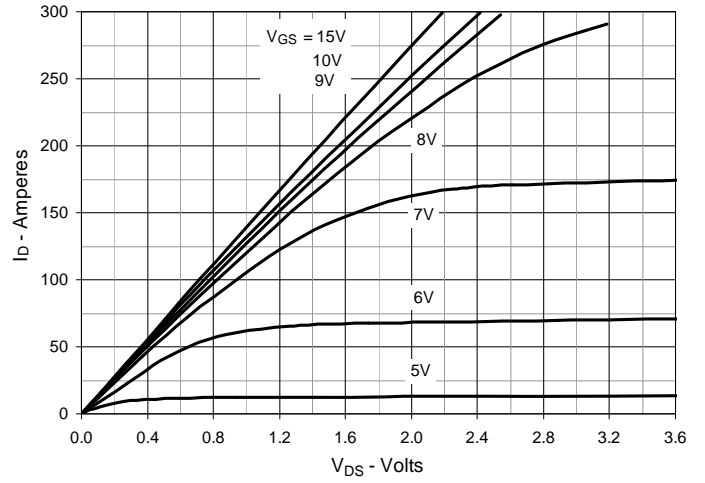
IXYS Reserves the Right to Change Limits, Test Conditions, and Dimensions.

IXYS MOSFETs and IGBTs are covered by one or more of the following U.S. patents:	4,835,592	4,931,844	5,049,961	5,237,481	6,162,665	6,404,065 B1	6,683,344	6,727,585	7,005,734 B2	7,157,338B2
	4,860,072	5,017,508	5,063,307	5,381,025	6,259,123 B1	6,534,343	6,710,405 B2	6,759,692	7,063,975 B2	
	4,881,106	5,034,796	5,187,117	5,486,715	6,306,728 B1	6,583,505	6,710,463	6,771,478 B2	7,071,537	

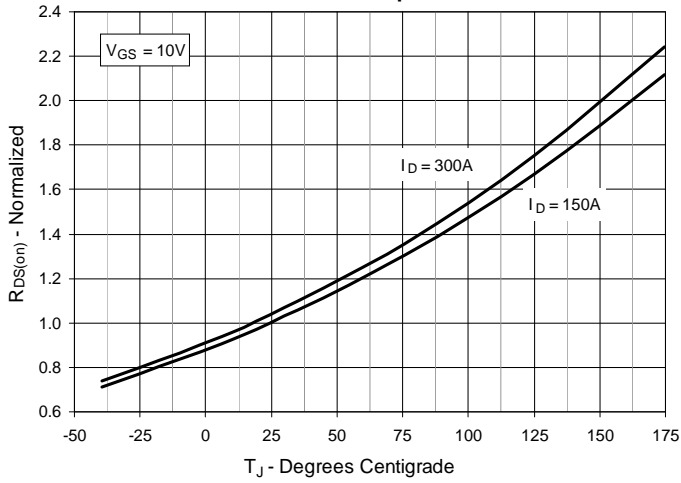
**Fig. 1. Extended Output Characteristics @  $T_J = 25^\circ\text{C}$**



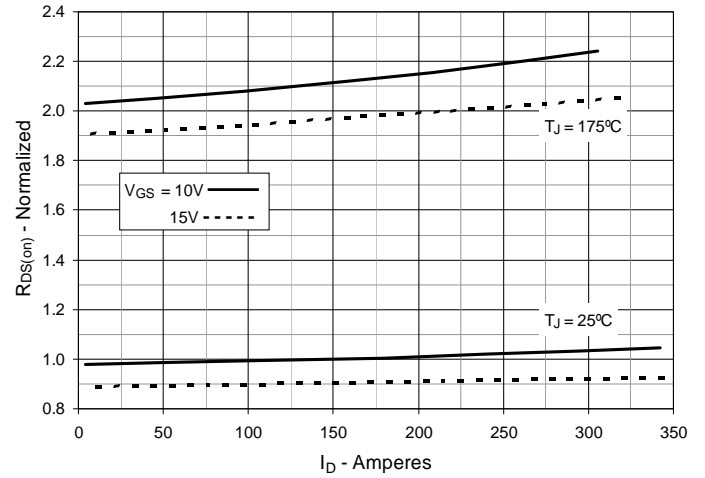
**Fig. 2. Output Characteristics @  $T_J = 150^\circ\text{C}$**



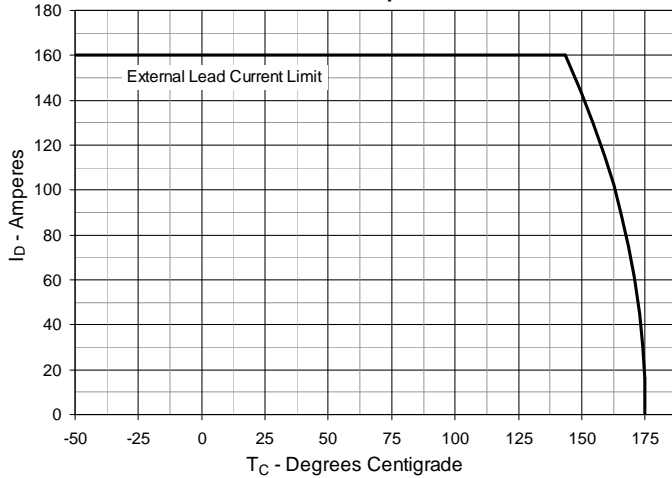
**Fig. 3.  $R_{DS(on)}$  Normalized to  $I_D = 150\text{A}$  Value vs. Junction Temperature**



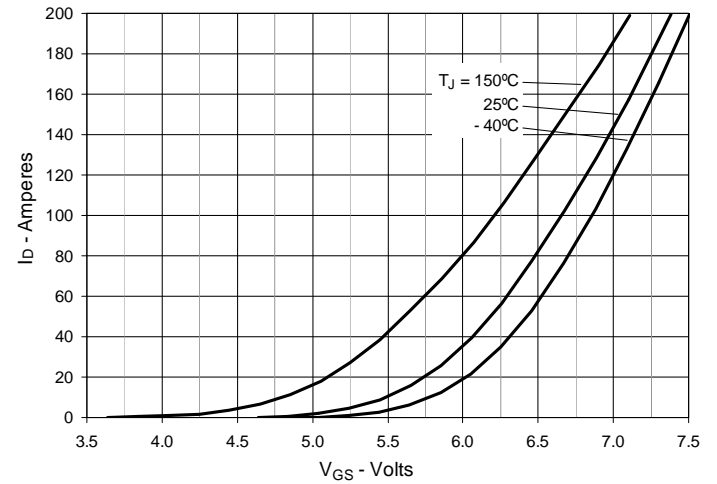
**Fig. 4.  $R_{DS(on)}$  Normalized to  $I_D = 150\text{A}$  Value vs. Drain Current**

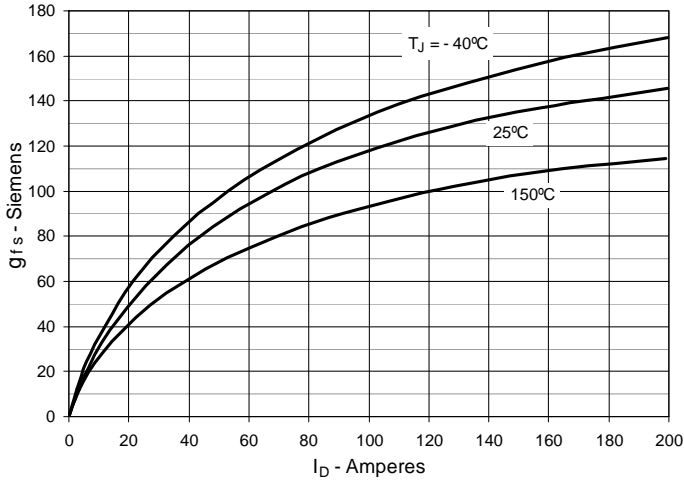
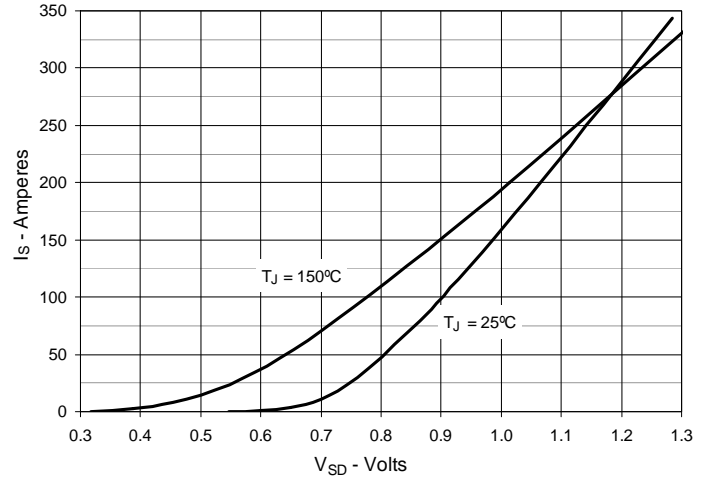
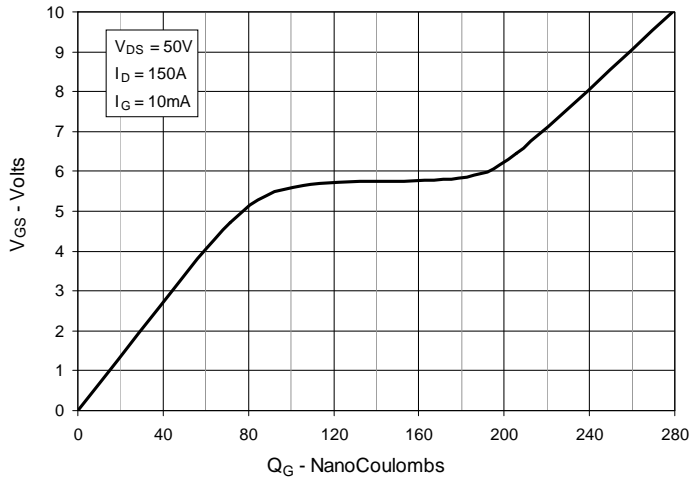
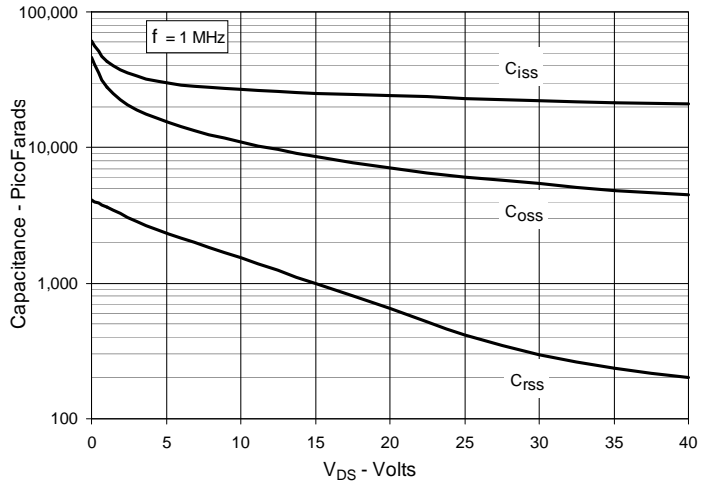
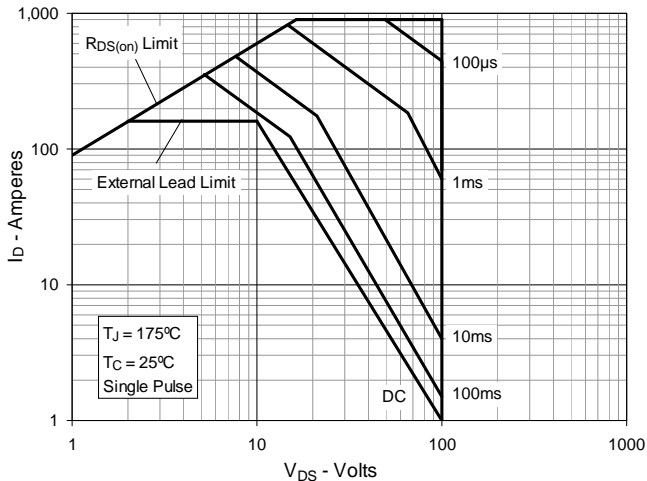
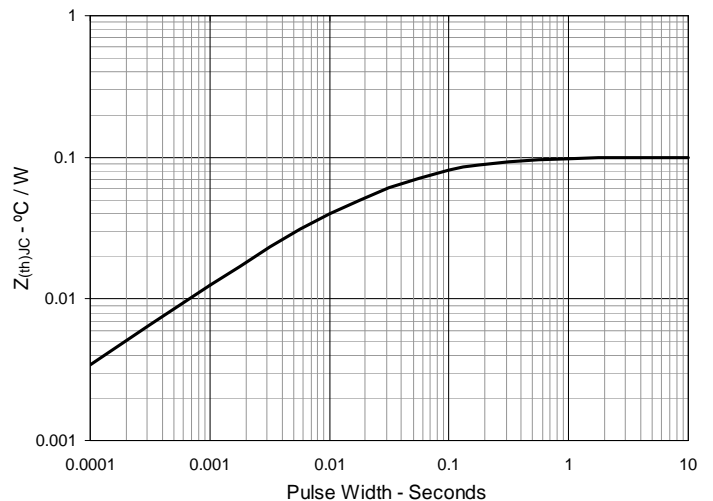


**Fig. 5. Maximum Drain Current vs. Case Temperature**



**Fig. 6. Input Admittance**



**Fig. . Transconductance**

**Fig. 8. Forward Voltage Drop of Intrinsic Diode**

**Fig. 9. Gate Charge**

**Fig. 10. Capacitance**

**Fig. 11. Forward-Bias Safe Operating Area**

**Fig. 12. Maximum Transient Thermal Impedance**




---

Disclaimer Notice - Information furnished is believed to be accurate and reliable. However, users should independently evaluate the suitability of and test each product selected for their own applications. Littelfuse products are not designed for, and may not be used in, all applications. Read complete Disclaimer Notice at [www.littelfuse.com/disclaimer-electronics](http://www.littelfuse.com/disclaimer-electronics).