

TL1275 SERIES TACT SWITCH

ANTI-VANDAL SWITCHES
 DETECTOR SWITCHES
 DIP SWITCHES
 KEYLOCK SWITCHES
 NAVIGATION SWITCHES
 PUSHBUTTON SWITCHES
 ROCKER SWITCHES
 ROTARY SWITCHES
 SLIDE SWITCHES
 SNAP ACTION SWITCHES
TACTILE SWITCHES
 TOGGLE SWITCHES
 CAP OPTIONS



APPLICATIONS / MARKETS



Audio / Visual

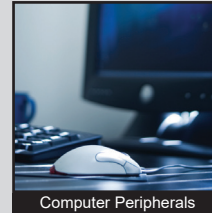

Computer Peripherals

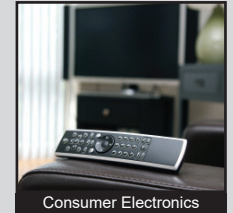

Consumer Electronics

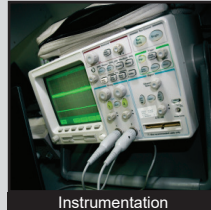

Instrumentation



Security Devices



Medical Equipment

RoHS

SPECIFICATIONS

Contact Arrangement: SPST
Contact Rating: 50mA @ 12VDC
Contact Resistance: 100mΩ Initial
Insulation Resistance: 100 MΩ Min.
Dielectric Strength: 250V RMS
Electrical Life: 100,000 cycles
Operating Temperature: -25°C to 70°C
Storage Temperature: -25°C to 70°C
Travel: 0.25mm
Actuation Force: 350 gf
Panel Thickness: 3.5mm Max.

FEATURES & BENEFITS

- 500mm long wire leads with connectors
- Single color and bi-color LED options
- Sharp tactile response
- Panel Mount

PART NUMBER CONFIGURATOR

Series	Actuator	Housing	Termination	Contact Material	Lens Style	LED Color
TL1275	C - Snap-in Bezel	A2 - Standard Housing	WA500 - 500mm Long Wire Leads	Q - Silver	P - Illuminated Power Symbol	R - Red B - Blue G - Green W - White Y - Yellow RG - Red-Green

Specifications subject to change without notice 9.28.2022



E-SWITCH®

www.e-switch.com

800.867.2717

1

TL1275 SERIES TACT SWITCH

BODY DIMENSIONS

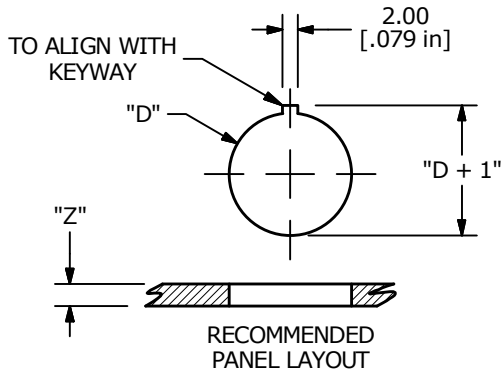

"Z"	"D"
0-0.5	16.0-16.1
0.5-2.0	16.1-16.2
2.0-2.5	16.2-16.4
2.5-3.0	16.4-16.6
3.0-3.5	16.6-16.8

WIRE CHART			
CONNECTOR	POSITION	SWITCH	WIRE
P1	1	1	300V 105°C 26 AWG AWM, BLACK
P1	2	2	300V 105°C 26 AWG AWM, BLACK
P2	1	+	300V 105°C 26 AWG AWM, RED
P2	2	-	300V 105°C 26 AWG AWM, GREEN

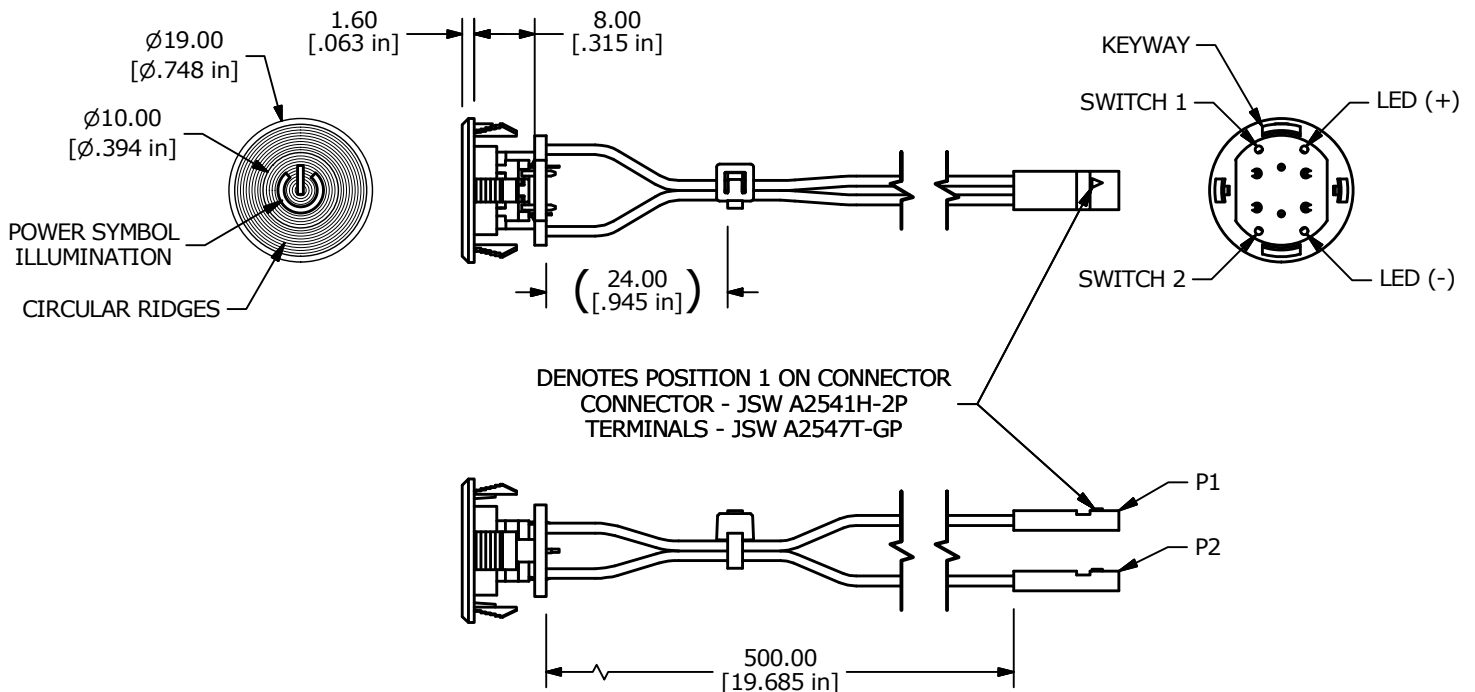
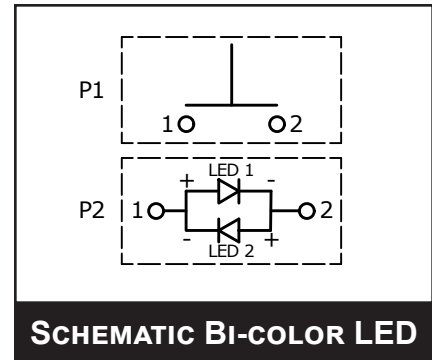
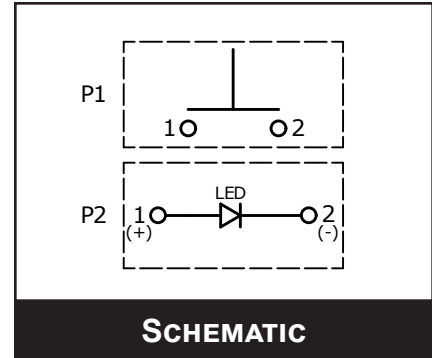

ANTI-VANDAL SWITCHES
DETECTOR SWITCHES
DIP SWITCHES
KEYLOCK SWITCHES
NAVIGATION SWITCHES
PUSHBUTTON SWITCHES
ROCKER SWITCHES
ROTARY SWITCHES
SLIDE SWITCHES
SNAP ACTION SWITCHES
TACTILE SWITCHES
TOGGLE SWITCHES
CAP OPTIONS