

ESD5425E
<http://www.sh-willsemi.com>
**4-Lines, Uni-directional, Low Capacitance
Transient Voltage Suppressors**
Descriptions

The ESD5425E is a low capacitance TVS (Transient Voltage Suppressor) array designed to protect high speed data interfaces. It has been specifically designed to protect sensitive electronic components which are connected to data and transmission lines from over-stress caused by ESD (Electrostatic Discharge).

The ESD5425E incorporates four pairs of low capacitance steering diodes plus a TVS diode.

The ESD5425E may be used to provide ESD protection up to $\pm 30\text{kV}$ (contact discharge) according to IEC61000-4-2, and withstand peak pulse current up to 80A (5/50ns) according to IEC61000-4-4, 25A (8/20 μs) according to IEC61000-4-5.

The ESD5425E is available in SOT-23-6L package. Standard products are Pb-free and Halogen-free.

Features

- Reverse stand-off voltage: 5V max.
- Transient protection for each line according to
IEC61000-4-2 (ESD): $\pm 30\text{kV}$ (contact discharge)
IEC61000-4-4 (EFT): 80A (5/50ns, Any I/O to GND)
IEC61000-4-5 (surge): 25A (8/20 μs , Any I/O to GND)
- Low capacitance: $C_{I/O-GND} = 3\text{pF}$ typ.
- Ultra-low leakage current: $I_R = 20\text{nA}$ typ.
- Low clamping voltage: $V_{CL} = 11.8\text{V}$ @ $I_{PP} = 16\text{A}$ (TLP)
- Solid-state silicon technology

Applications

- USB 2.0
- Video Graphics Cards
- DVI
- IEEE 1394
- Monitors and Flat Panel Displays
- 10/100 Ethernet
- Notebooks

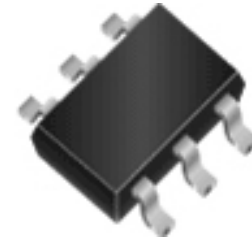
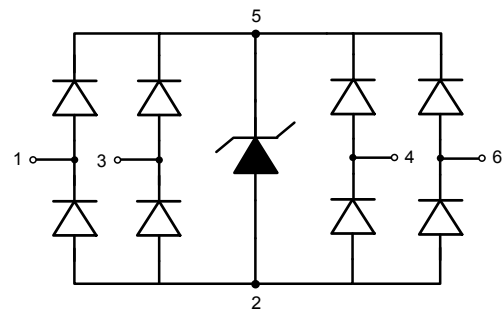
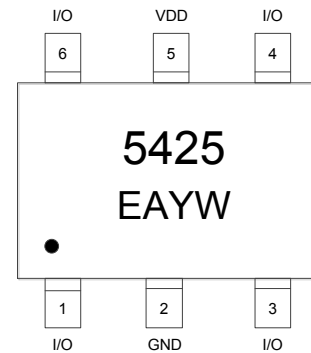
SOT-23-6L

Circuit diagram

5425 = Device code
EA = Special code
YW = Date code

Marking & Pin configuration (Top View)
Order information

Device	Package	Shipping
ESD5425E-6/TR	SOT-23-6L	3000/Tape&Reel

Absolute maximum ratings

Parameter	Symbol	Rating	Unit
Peak pulse power ($t_p = 8/20\mu s$)	P_{pk}	350	W
Peak pulse current ($t_p = 8/20\mu s$)	I_{PP}	25	A
ESD according to IEC61000-4-2 air discharge	V_{ESD}	± 30	kV
ESD according to IEC61000-4-2 contact discharge		± 30	
Junction temperature	T_J	125	$^{\circ}C$
Operation temperature	T_{OP}	-40 to 85	$^{\circ}C$
Storage temperature	T_{STG}	-55 to 150	$^{\circ}C$
Lead temperature	T_L	260	$^{\circ}C$

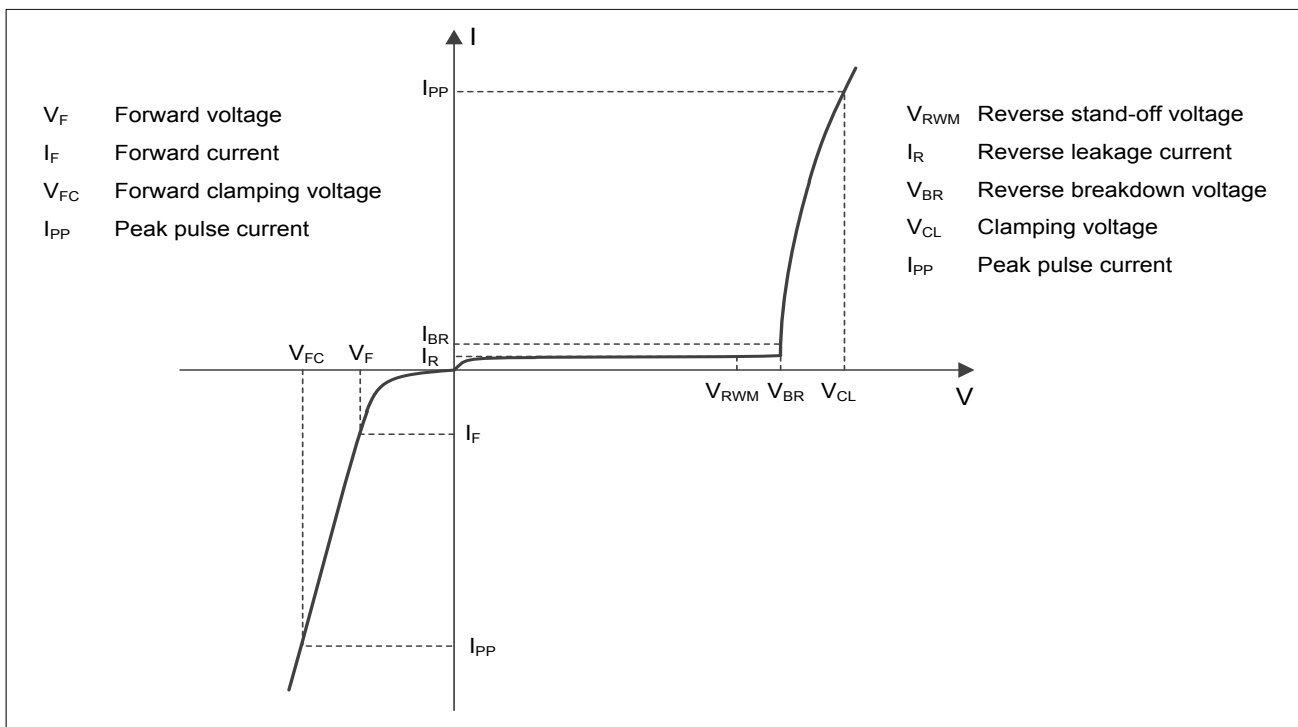
Electrical characteristics ($T_A = 25^{\circ}C$, unless otherwise noted)

Definitions of electrical characteristics

Electrical characteristics (T_A = 25°C, unless otherwise noted)

Parameter	Symbol	Condition	Min.	Typ.	Max.	Unit
Reverse stand-off voltage	V _{RWM}				5.0	V
Reverse leakage current	I _R	V _{RWM} = 5V			1	uA
Reverse breakdown voltage	V _{BR}	I _{BR} = 1mA	7.0	8.5	9.5	V
Forward voltage	V _F	I _F = 10mA	0.6	0.9	1.2	V
Clamping voltage ¹⁾	V _{CL}	I _{PP} = 16A, t _p = 100ns		11.8		V
Dynamic resistance ¹⁾	R _{DYN}	t _p = 100ns		0.12		Ω
Clamping voltage ²⁾	V _{CL}	V _{ESD} = 8kV		12.0		V
Clamping voltage ³⁾	V _{CL}	I _{PP} = 1A, t _p = 8/20μs		9.5		V
		I _{PP} = 25A, t _p = 8/20μs		14.0		V
Dynamic resistance ³⁾	R _{DYN}	t _p = 8/20μs		0.19		Ω
Junction capacitance	C _{I/O - GND}	V _R = 0V, f = 1MHz, VDD = floated, any I/O to GND		3.0	5.0	pF
	C _{I/O - I/O}	V _R = 0V, f = 1MHz, any I/O to I/O		1.5	2.5	pF

Notes:

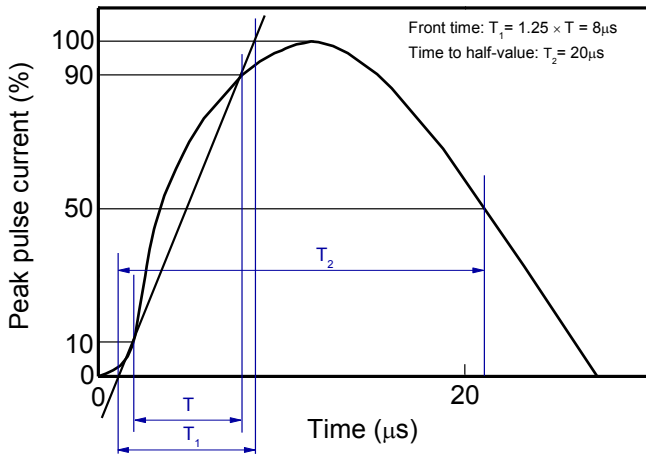
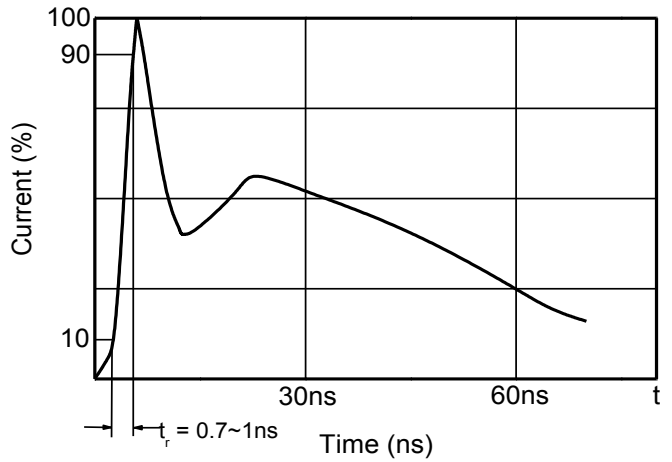
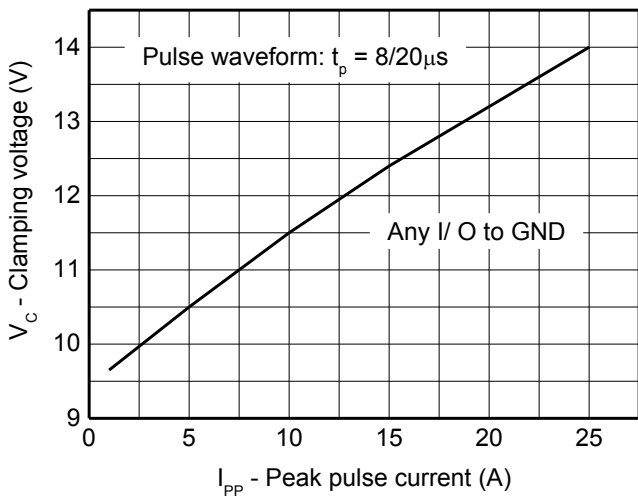
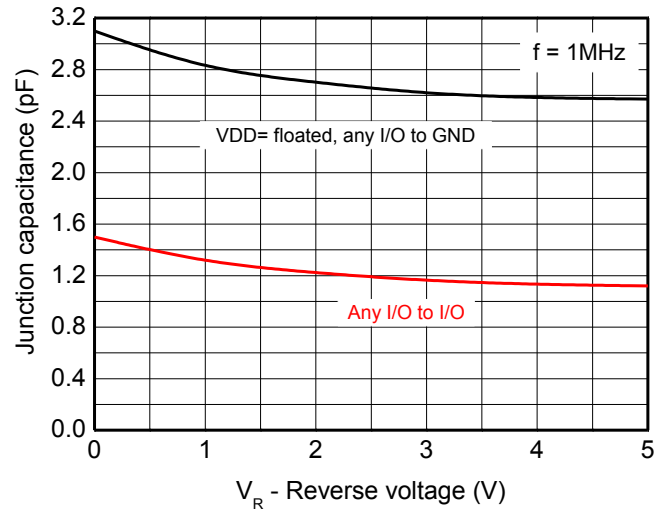
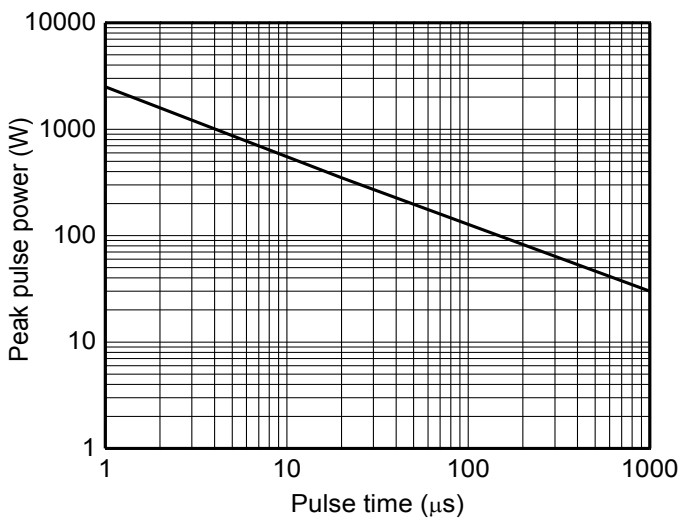
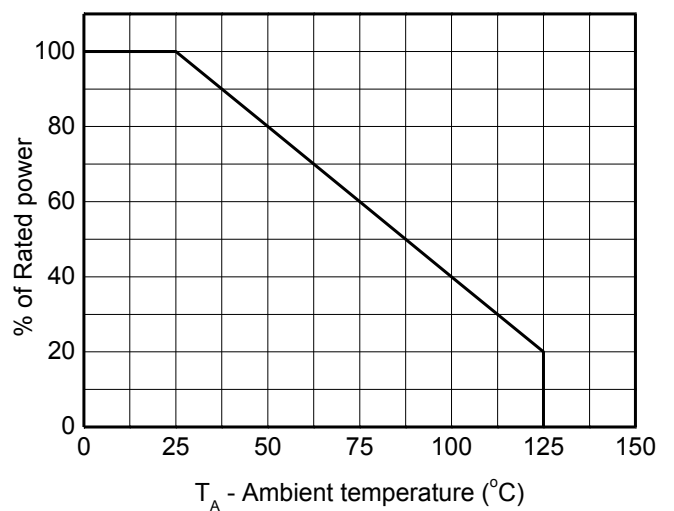
- 1) TLP parameter: Z₀ = 50Ω, t_p = 100ns, t_r = 2ns, averaging window from 60ns to 80ns. R_{DYN} is calculated from 10A to 30A.
- 2) Contact discharge mode, according to IEC61000-4-2.
- 3) Non-repetitive current pulse, according to IEC61000-4-5. R_{DYN} is calculated from 5A to 20A.

Typical characteristics ($T_A = 25^\circ\text{C}$, unless otherwise noted)

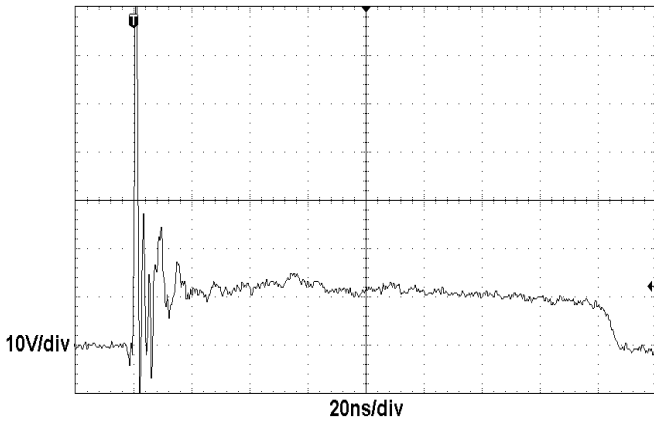
8/20 μs waveform per IEC61000-4-5

Contact discharge current waveform per IEC61000-4-2

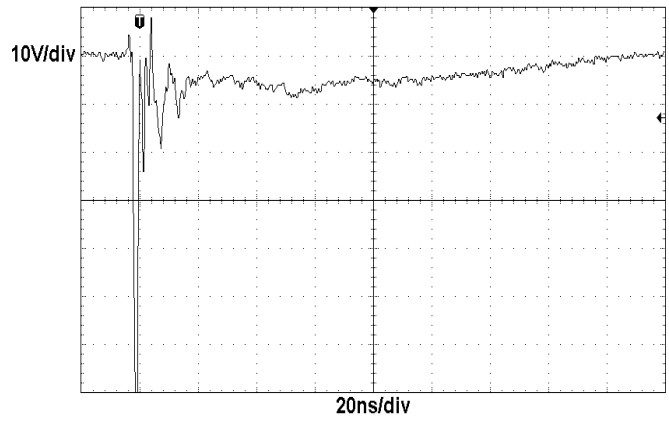
Clamping voltage vs. Peak pulse current

Capacitance vs. Reverse voltage

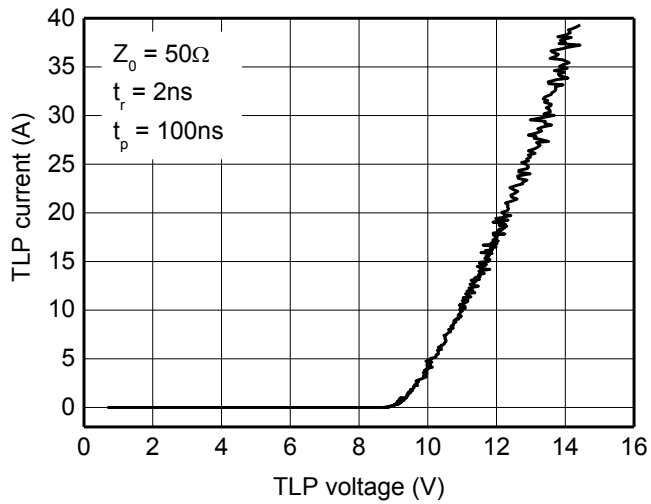
Non-repetitive peak pulse power vs. Pulse time

Power derating vs. Ambient temperature

Typical characteristics ($T_A = 25^\circ\text{C}$, unless otherwise noted)

ESD clamping
 (+8kV contact discharge per IEC61000-4-2)



ESD clamping
 (-8kV contact discharge per IEC61000-4-2)

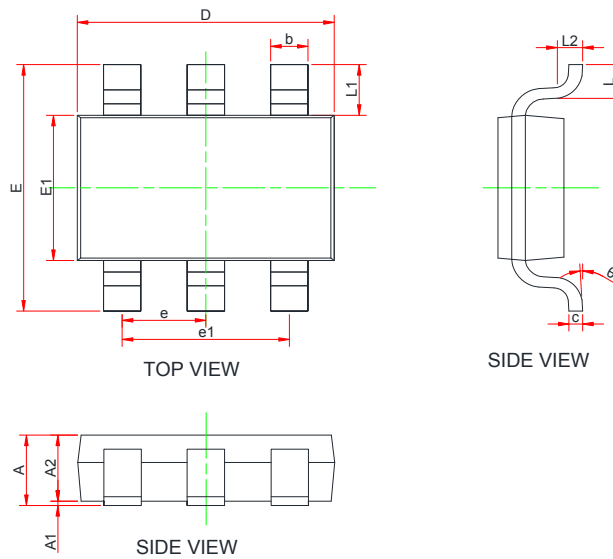

TLP Measurement

PACKAGE OUTLINE DIMENSIONS
SOT-23-6L

Symbol	Dimensions in Millimeters		
	Min.	Typ.	Max.
A	1.05	-	1.45
A1	0	-	0.15
A2	1.00	1.15	1.30
b	0.30	0.40	0.50
c	0.10	-	0.21
D	2.72	2.92	3.12
E	2.60	2.80	3.00
E1	1.40	1.60	1.80
e	0.85	0.95	1.05
e1	1.80	1.90	2.00
L	0.30	-	0.60
L1	0.25 BSC		
θ	0 °	-	8 °

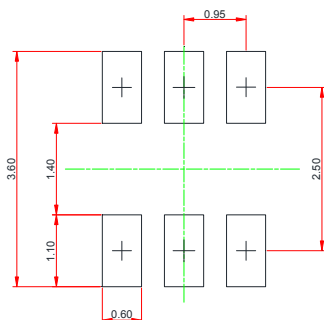
Recommended land pattern (Unit: mm)

Notes:

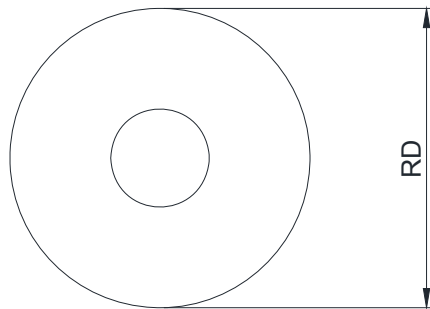
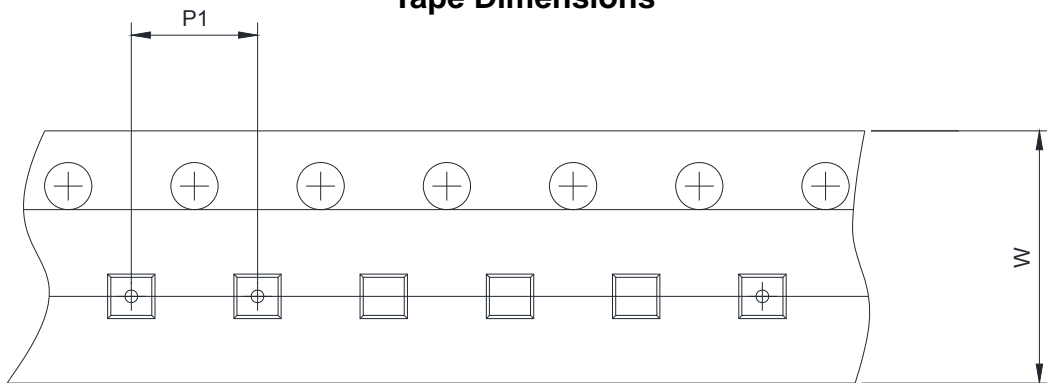
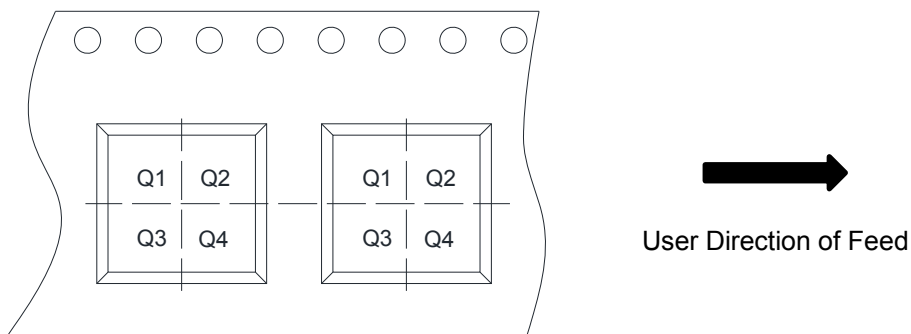
This recommended land pattern is for reference purposes only. Please consult your manufacturing group to ensure your PCB design guidelines are met.

TAPE AND REEL INFORMATION
Reel Dimensions

Tape Dimensions

Quadrant Assignments For PIN1 Orientation In Tape

RD	Reel Dimension	<input checked="" type="checkbox"/> 7inch	<input type="checkbox"/> 13inch	
W	Overall width of the carrier tape	<input checked="" type="checkbox"/> 8mm	<input type="checkbox"/> 12mm	<input type="checkbox"/> 16mm
P	Pitch between successive cavity centers	<input type="checkbox"/> 2mm	<input checked="" type="checkbox"/> 4mm	<input type="checkbox"/> 8mm
Pin1	Pin1 Quadrant	<input type="checkbox"/> Q1	<input type="checkbox"/> Q2	<input checked="" type="checkbox"/> Q3 <input type="checkbox"/> Q4