



概述

LM2576系列的稳压器是单片集成电路，能提供降压开关稳压器（buck）的各种功能，能驱动3A的负载，有优异的线性和负载调整能力。这些器件的固定输出电压有3.3V，5V，12V，15V，还有可调整输出的型号。

这些稳压器内部含有频率补偿器和一个固定频率振荡器，将外部元件的数目减到最少，使用简便。

LM2576的效率比流行的三段线性稳压器要高的多，是理想的替代。一般情况下不需要或只要很小尺寸的外加散热片。已经优化可和LM2576一起使用的标准系列电感由好几个不同的电感生成商提供。此特征大大简化了开关电源的设计。

其它特征包括：在指定输入电压和输出负载条件下保证输出电压的 $\pm 4\%$ 误差，以及振荡器频率的 $\pm 10\%$ 误差。还包括外部的关断电路，特征有50 μ A（典型值）待机电流。

输出开关包括逐周限流，以及在故障状态下提供完全保护的热关断功能。

特点

- 3.3V, 5V, 12V, 15V 和可调节输出电压型号
- 可调节输出型号输出电压范围在线性和负载条件下 1.23~37V（HV型号57V）最大 $\pm 4\%$
- 保证3.0A输出电流
- 输入电压范围广，40V至HV型号的60V
- 只需4个外部器件支持
- 52kHz固定频率内部振荡器
- TTL关断能力，低功耗待机模式
- 高效率
- 使用现成可用的标准电感
- 热关断及电流限制保护

应用

- 简单高效的降压（Buck）稳压器
- 线性稳压器的高效预稳压器
- 卡上开关稳压器
- 正到负的变换器（Buck-Boost）
- 负升压变换器
- 为电池充电器做电源
- 与National Semi.、On Semi.的LM2576完全互换

订购信息

工作温度范围	输出电压					封装形式
	3.3	5.0	12	15	可调	
	LM2576S-3.3	LM2576S-5.0	LM2576S-12	LM2576S-15	LM2576S-ADJ	TO-263-5L
	LM2576HVS-3.3	LM2576HVS-5.0	LM2576HVS-12	LM2576HVS-15	LM2576HVS-ADJ	
	LM2576T-3.3	LM2576T-5.0	LM2576T-12	LM2576T-15	LM2576T-ADJ	TO-220-5L (TO-220-5)
	LM2576HVT-3.3	LM2576HVT-5.0	LM2576HVT-12	LM2576HVT-15	LM2576HVT-ADJ	

管脚定义

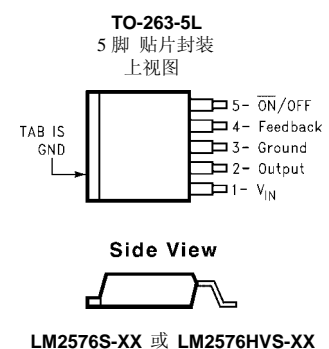
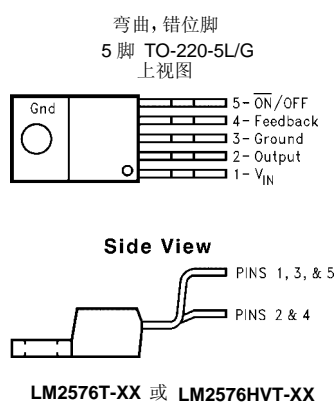
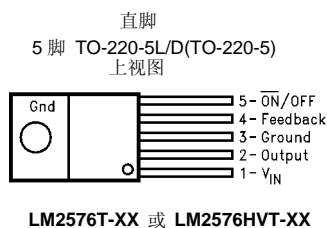



典型应用 (固定输出电压型号)



图 1

框图



3.3V R2 = 1.7k
5V, R2 = 3.1k
12V, R2 = 8.84k
15V, R2 = 11.3k
可调节型号
R1 = 开路, R2 = 0Ω

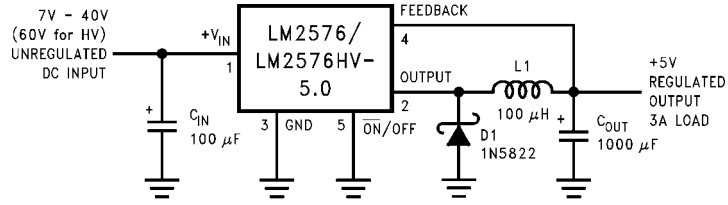
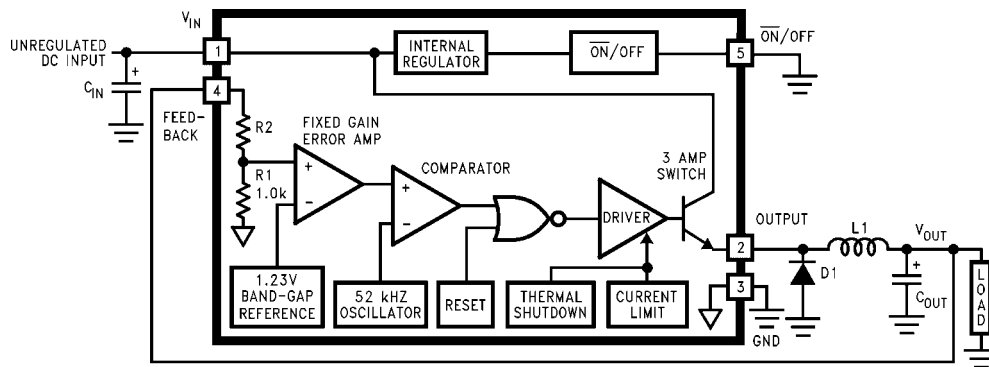

绝对最大额定值(注 1)

最大电源电压		保存温度范围	-65°C 至 +150°C
LM2576	45V	最大结温	150°C
LM2576HV	63V	最小静电放电额定值	
通/断管脚输入电压	$-0.3V \leq V \leq +V_{IN}$	(C = 100 pF, R = 1.5 kΩ)	2kV
对地输出电压 (稳态)	-1V	引线温度	
功耗	内部限定	(焊接, 10 秒)	260°C

工作额定值

工作结温范围		电源电压	
LM2576/LM2576HV	$-40^{\circ}\text{C} \leq T_J \leq +125^{\circ}\text{C}$	LM2576	40V
		LM2576HV	60V

LM2576-3.3, LM2576HV-3.3 电气特性

标准字体的指标值是在 $T_J = 25^{\circ}\text{C}$, **粗体字**适用于整个工作结温范围.

符号	特性	条件	LM2576-3.3 LM2576HV-3.3		单位 (极限)
			典型值	极限值 (注 2)	
系统参数 (注 3) 测试电路 图 2					
V_{OUT}	输出电压	$V_{IN} = 12V, I_{负载} = 0.5A$ 电路图 2	3.3	3.234 3.366	V V(最小) V(最大)
V_{OUT}	输出电压 LM2576	$6V \leq V_{IN} \leq 40V, 0.5A \leq I_{负载} \leq 3A$ 电路图 2	3.3	3.168/ 3.135 3.432/ 3.465	V V(最小) V(最大)
V_{OUT}	输出电压 LM2576HV	$6V \leq V_{IN} \leq 60V, 0.5A \leq I_{负载} \leq 3A$ 电路图 2	3.3	3.168/ 3.135 3.450/ 3.482	V V(最小) V(最大)
η	效率	$V_{IN} = 12V, I_{负载} = 3A$	75		%

LM2576-5.0, LM2576HV-5.0 电气特性

标准字体的指标值是在 $T_J = 25^{\circ}\text{C}$, **粗体字**适用于整个工作结温范围.

符号	特性	条件	LM2576-5.0 LM2576HV-5.0		单位 (极限)
			典型值	极限值 (注 2)	
系统参数 (注 3) 测试电路 图 2					
V_{OUT}	输出电压	$V_{IN} = 12V, I_{负载} = 0.5A$ 电路图 2	5.0	4.900 5.100	V V(最小) V(最大)
V_{OUT}	输出电压 LM2576	$8V \leq V_{IN} \leq 40V, 0.5A \leq I_{负载} \leq 3A$ 电路图 2	5.0	4.800/ 4.750 5.200/ 5.250	V V(最小) V(最大)
V_{OUT}	输出电压 LM2576HV	$8V \leq V_{IN} \leq 60V, 0.5A \leq I_{负载} \leq 3A$ 电路图 2	5.0	4.800/ 4.750 5.225/ 5.275	V V(最小) V(最大)
η	效率	$V_{IN} = 12V, I_{负载} = 3A$	77		%



LM2576-12, LM2576HV-12 电气特性

标准字体的指标值是在 $T_J = 25^\circ\text{C}$, **粗体字**适用于整个工作结温范围

符号	特性	条件	LM2576-12 LM2576HV-12		单位 (极限)
			典型值	极限值 (注 2)	
系统参数 (注 3) 测试电路 图 2					
V_{OUT}	输出电压	$V_{IN} = 25\text{V}$, $I_{负载} = 0.5\text{A}$ 电路图 2	12	11.76 12.24	V V(最小) V(最大)
V_{OUT}	输出电压 LM2576	$15\text{V} \leq V_{IN} \leq 40\text{V}$, $0.5\text{A} \leq I_{负载} \leq 3\text{A}$ 电路图 2	12	11.52/ 11.40 12.48/ 12.60	V V(最小) V(最大)
V_{OUT}	输出电压 LM2576HV	$15\text{V} \leq V_{IN} \leq 60\text{V}$, $0.5\text{A} \leq I_{负载} \leq 3\text{A}$ 电路图 2	12	11.52/ 11.40 12.54/ 12.66	V V(最小) V(最大)
η	效率	$V_{IN} = 15\text{V}$, $I_{负载} = 3\text{A}$	88		%

LM2576-15, LM2576HV-15 电气特性

标准字体的指标值是在 $T_J = 25^\circ\text{C}$, **粗体字**适用于整个工作结温范围.

符号	特性	条件	LM2576-15 LM2576HV-15		单位 (极限))
			典型值	极限值 (注 2)	
系统参数 (注 3) 测试电路 图 2					
V_{OUT}	输出电压	$V_{IN} = 25\text{V}$, $I_{负载} = 0.5\text{A}$ 电路图 2	15	14.70 15.30	V V(最小) V(最大)
V_{OUT}	输出电压 LM2576	$18\text{V} \leq V_{IN} \leq 40\text{V}$, $0.5\text{A} \leq I_{负载} \leq 3\text{A}$ 电路图 2	15	14.40/ 14.25 15.60/ 15.75	V V(最小) V(最大)
V_{OUT}	输出电压 LM2576HV	$18\text{V} \leq V_{IN} \leq 60\text{V}$, $0.5\text{A} \leq I_{负载} \leq 3\text{A}$ 电路图 2	15	14.40/ 14.25 15.68/ 15.83	V V(最小) V(最大)
η	效率	$V_{IN} = 18\text{V}$, $I_{负载} = 3\text{A}$	88		%

LM2576-ADJ, LM2576HV-ADJ 电气特性

标准字体的指标值是在 $T_J = 25^\circ\text{C}$, **粗体字**适用于整个工作结温范围.

符号	特性	条件	LM2576-ADJ LM2576HV-ADJ		单位 (极限)
			典型值	极限值 (注 2)	
系统参数 (注 3) 测试电路 图 2					
V_{OUT}	反馈电压	$V_{IN} = 12\text{V}$, $I_{负载} = 0.5\text{A}$ $V_{OUT} = 5\text{V}$ 电路图 2	1.230	1.217 1.243	V V(最小) V(最大)
V_{OUT}	反馈电压 LM2576	$8\text{V} \leq V_{IN} \leq 40\text{V}$, $0.5\text{A} \leq I_{负载} \leq 3\text{A}$ $V_{OUT} = 5\text{V}$ 电路图 2	1.230	1.193/ 1.180 1.267/ 1.280	V V(最小) V(最大)
V_{OUT}	反馈电压 LM2576HV	$8\text{V} \leq V_{IN} \leq 60\text{V}$, $0.5\text{A} \leq I_{负载} \leq 3\text{A}$ $V_{OUT} = 5\text{V}$ 电路图 2	1.230	1.193/ 1.180 1.273/ 1.286	V V(最小) V(最大)
η	效率	$V_{IN} = 12\text{V}$, $I_{负载} = 3\text{A}$, $V_{OUT} = 5\text{V}$	77		%



所有输出电压器件的电气特性

标准字体的指标值是在 $T_J = 25^\circ\text{C}$, **粗体字**适用于整个工作结温范围. 除非另有说明, 对3.3V, 5V和可调节型号 $V_{IN} = 12\text{V}$; 对12V型号 $V_{IN} = 25\text{V}$, 对15V型号 $V_{IN} = 30\text{V}$. $I_{\text{负载}} = 500\text{mA}$.

符号	特性	条件	LM2576-XX LM2576HV-XX		单位 (极限)
			典型值	极限值 (注 2)	
器件参数					
I_b	反馈偏置电流	$V_{\text{OUT}} = 5\text{V}$ (只对可调节型号)	50	100/ 500	nA
f_o	振荡器频率	(注 11)	52	47/42 58/63	kHz kHz(最小) kHz(最大)
V_{SAT}	饱和电压	$I_{\text{OUT}} = 3\text{A}$ (注 4)	1.4	1.8/2.0	V V(最大)
DC	最大占空比 (导通)	(注 5)	98	93	% %(最小)
I_{CL}	电流极限	(注 4, 11)	5.8	4.2/3.5 6.9/7.5	A A(最小) A(最大)
I_L	输出漏电流	(注 6, 7): 输出 = 0V 输出 = -1V 输出 = -1V	7.5	2 30	mA(最大) mA mA(最大)
I_Q	静态电流	(注 6)	5	10	mA mA(最大)
I_{STBY}	待机静态电流	通 / 断 管脚 = 5V (截止断)	50	200	μA μA (最大)
θ_{JA} θ_{JA} θ_{JC} θ_{JA}	热阻	T 形封装, 结至环境 (注 8) T 形封装, 结至环境 (注 9) T 形封装, 结至外壳 S 形封装, 结至环境 (注 10)	65 45 2 50		$^\circ\text{C/W}$
通 / 断控制 测试电路 图 2					
V_{IH}	通 / 断 管脚	$V_{\text{OUT}} = 0\text{V}$	1.4	2.2/2.4	V(最小)
V_{IL}	逻辑输入电平	$V_{\text{OUT}} =$ 标称输出电压	1.2	1.0/0.8	V(最大)
I_{IH}	通 / 断 管脚	通 / 断 管脚 = 5V (断)	12	30	μA μA (最大)
I_{IL}	输入电流	通 / 断 管脚 = 0V (通)	0	10	μA μA (最大)

注 1: 绝对最大额定值表示为极限值, 若超过此范围则有可能损坏器件. 工作额定值指在此情况下器件应该能工作, 但并不保证规定的性能极限值. 对保证的指标和测试条件, 见电气特性.

注 2: 所有的极限值保证的是在室温下 (标准字体), 和整个工作结温范围 (**粗体字**).

注 3: 外部元件如箝位二极管、电感、输入输出电容会影响开关稳压器系统性能. 当LM2576/ LM2576HV 应用于如图2的测试电路, 系统性能将如电气特性中的系统参数部分所示.

注 4: 输出拉电流. 输出脚上不接二极管, 电感或电容.

注 5: 反馈脚与输出断开, 接至 0V.

采用1/4英寸引脚焊接至引脚周围有约4平方英寸铜面积的PCB板上

注 6: 反馈脚与输出断开, 对可调节型号及 3.3V, 5.0V型号接 +12V, 对 12V, 15V型号接 +25V, 以使输出晶体管“截止”。

注 7: $V_{\text{IN}} = 40\text{V}$ (高压型号是 60V)。

注 8: 垂直安装5脚TO-220-5L封装件至热阻材料上 (无外接散热片), 采用1/2英寸脚接入管座, 或接入铜面积最少的PCB板上。

注 9: 垂直安装5脚TO-220-5L封装件至热阻材料上 (无外接散热片), 采用1/4英寸引脚焊接至引脚周围有约4平方英寸铜面积的PCB板上。

注 10: 如果使用TO-263-5L封装, 可通过增加PCB板与封装件热合在一起的铜面积降低热阻。0.5平方英寸的铜面积, θ_{JA} 是 50°C/W ; 1平方英寸的铜面积, θ_{JA} 是 37°C/W ; 1.6或以上平方英寸的铜面积, θ_{JA} 是 32°C/W 。

注 11: 当输出短路或过载时稳压输出电压会下降约标称输出电压的40%, 此时振荡频率下降到约11kHz, 这一自我保护特性将最小占空比从5%降到大约2%来减小集成电路的平均损耗。



典型性能特性曲线 (电路图2)

归一化输出电压

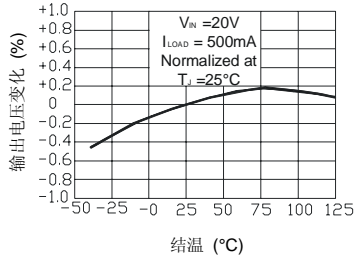

电源调整率

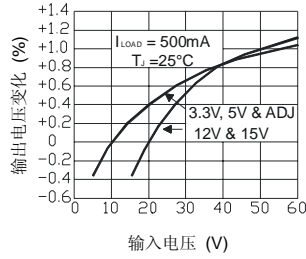

电压降落

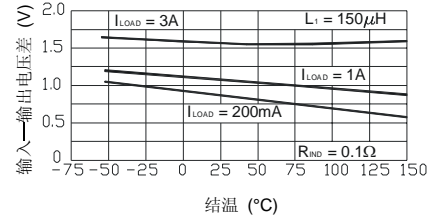

待机静态电流

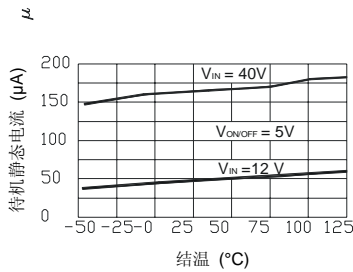

静态电流

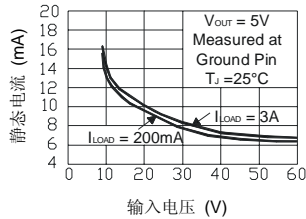

电流极限值

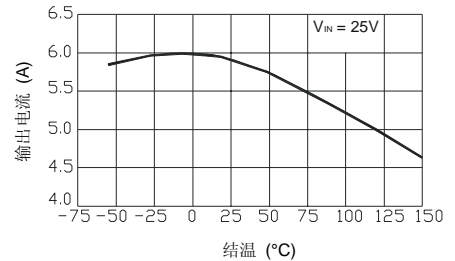

开关饱和电压

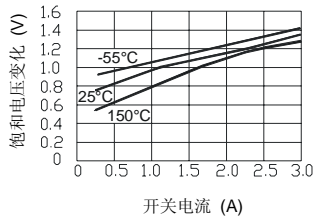

效率

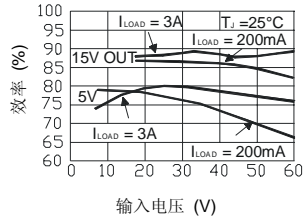

振荡器频率

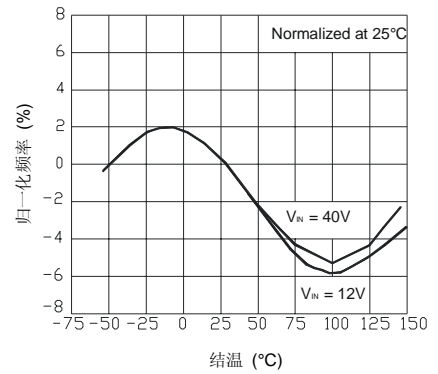

最小工作电压

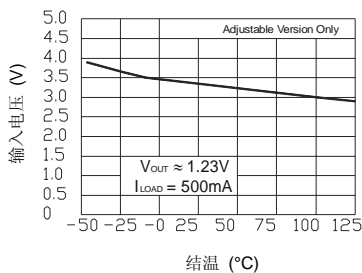

静态电流—占空比

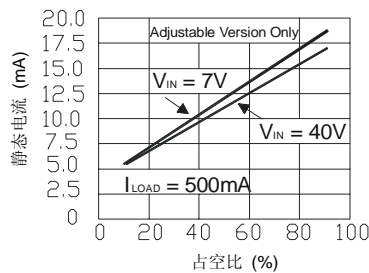

反馈电压—占空比

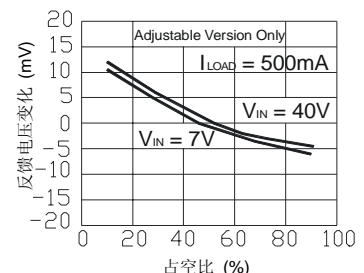



最大能量消耗
(TO-263-5L) (参见注 10)

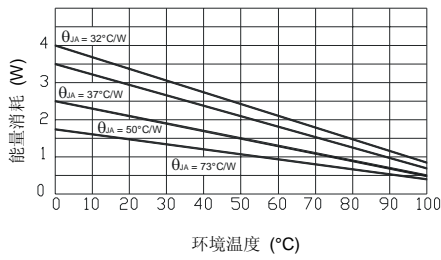

反馈脚电流

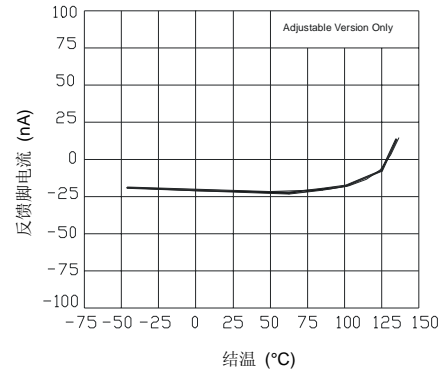

开关波形

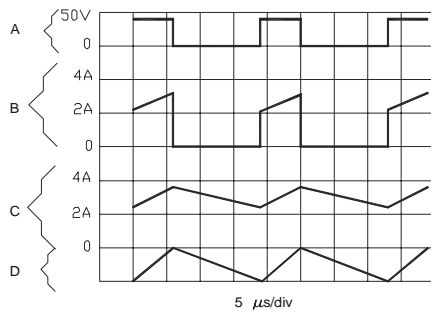

负载瞬态响应

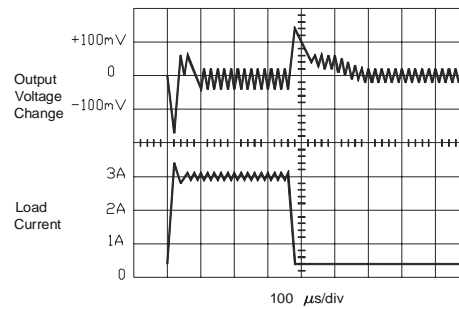

$V_{OUT}=15V$

- A: 输出管脚电压, 10V/格
 - B: 输出管脚电流, 2.0A/格
 - C: 电感电流, 2.0A/格
 - D: 输出脉动电压, 50mV/格, 交流耦合。
- 水平时基: 5μS/格



测试电路和PCB布局原则

在任何开关稳压器中，印刷电路板的布局都很重要。由于引线电感，快速切换的电流会引起电压瞬变，造成许多问题。要使电感和接地回路最小，就要使用粗线标出的引线尽量短。

要获得最好的结果，应使用单点接地（如图示）或接地平面结构。当使用可调节型号的稳压器时，应把调节电阻尽可能靠近稳压器，让敏感的反馈接线尽量短。

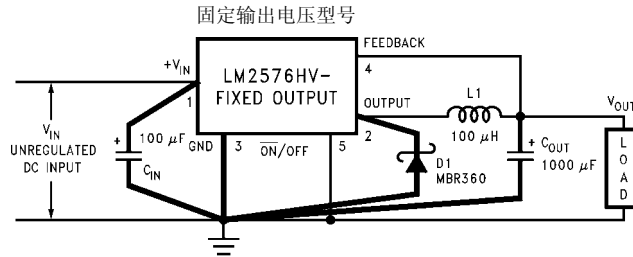

- C_{IN} — 100 μF, 75V, 铝电解
- C_{OUT} — 1000 μF, 25V, 铝电解
- D₁ — 肖特基, MBR360
- L₁ — 100 μH, 脉冲, PE-92108
- R₁ — 2k, 0.1%
- R₂ — 6.12k, 0.1%

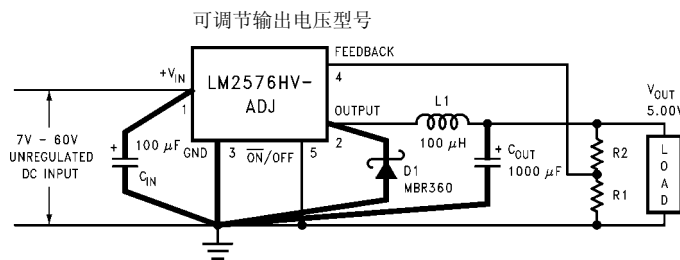

$$V_{OUT} = V_{REF} \left(1 + \frac{R_2}{R_1} \right)$$

$$R_2 = R_1 \left(\frac{V_{OUT}}{V_{REF}} - 1 \right)$$

其中, $V_{REF} \approx 1.23V$, R_1 在 $1.0k\Omega$ 和 $5.0k\Omega$ 之间

图 2



封装信息

TO-220-5L/G

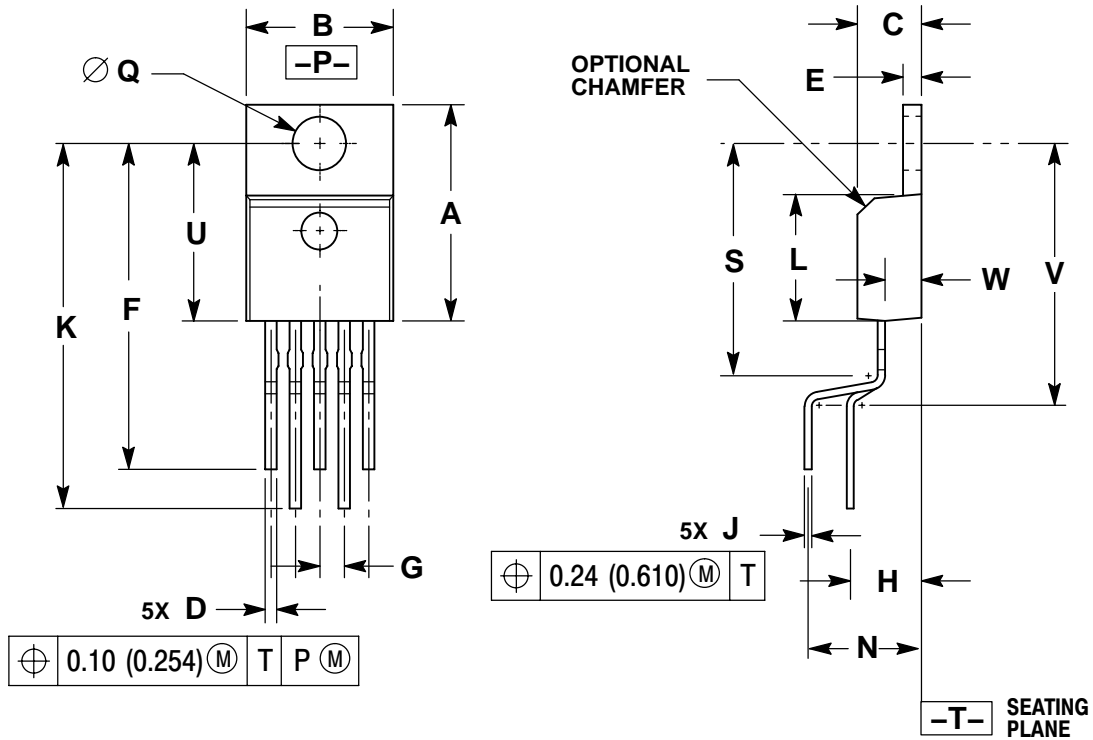

DIM	INCHES		MILLIMETERS	
	MIN	MAX	MIN	MAX
A	0.572	0.613	14.529	15.570
B	0.390	0.415	9.906	10.541
C	0.170	0.180	4.318	4.572
D	0.025	0.038	0.635	0.965
E	0.048	0.055	1.219	1.397
F	0.850	0.935	21.590	23.749
G	0.067 BSC		1.702 BSC	
H	0.166 BSC		4.216 BSC	
J	0.015	0.025	0.381	0.635
K	0.900	1.100	22.860	27.940
L	0.320	0.365	8.128	9.271
N	0.320 BSC		8.128 BSC	
Q	0.140	0.153	3.556	3.886
S	---	0.620	---	15.748
U	0.468	0.505	11.888	12.827
V	---	0.735	---	18.669
W	0.090	0.110	2.286	2.794



TO-220-5L/D(TO-220-5)

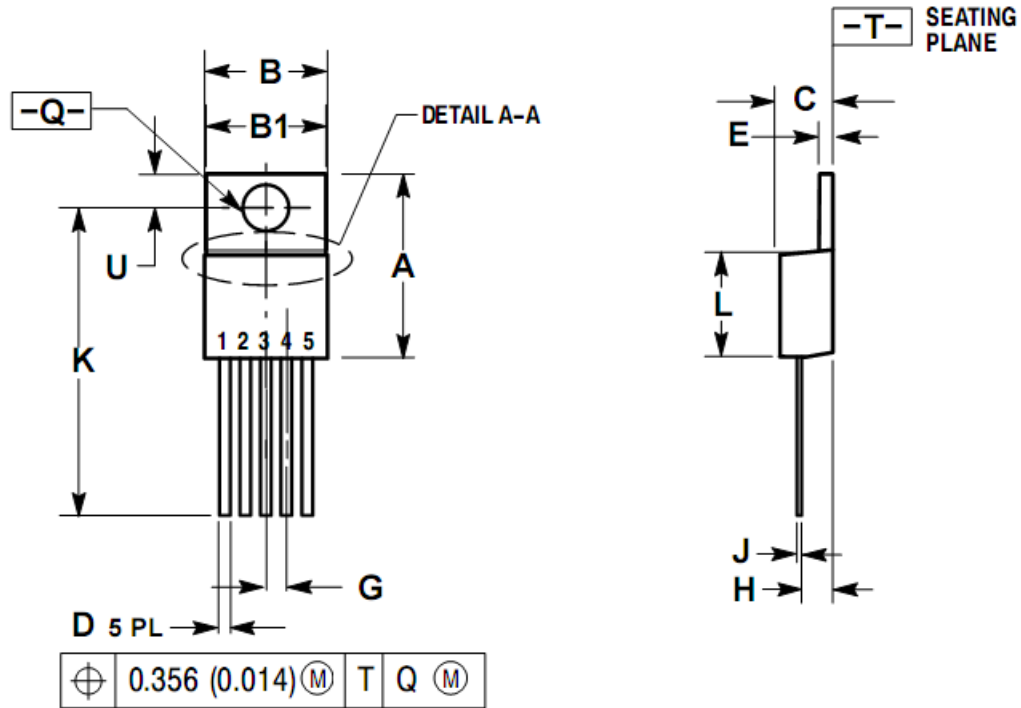

DIM	INCHES		MILLIMETERS	
	MIN	MAX	MIN	MAX
A	0.572	0.613	14.529	15.570
B	0.390	0.415	9.906	10.541
B1	0.375	0.415	9.525	10.541
C	0.170	0.180	4.318	4.572
D	0.025	0.038	0.635	0.965
E	0.048	0.055	1.219	1.397
G	0.067 BSC		1.702 BSC	
H	0.087	0.112	2.210	2.845
J	0.015	0.025	0.381	0.635
K	0.977	1.045	24.810	26.543
L	0.320	0.365	8.128	9.271
Q	0.140	0.153	3.556	3.886
U	0.105	0.117	2.667	2.972



TO-263-5L

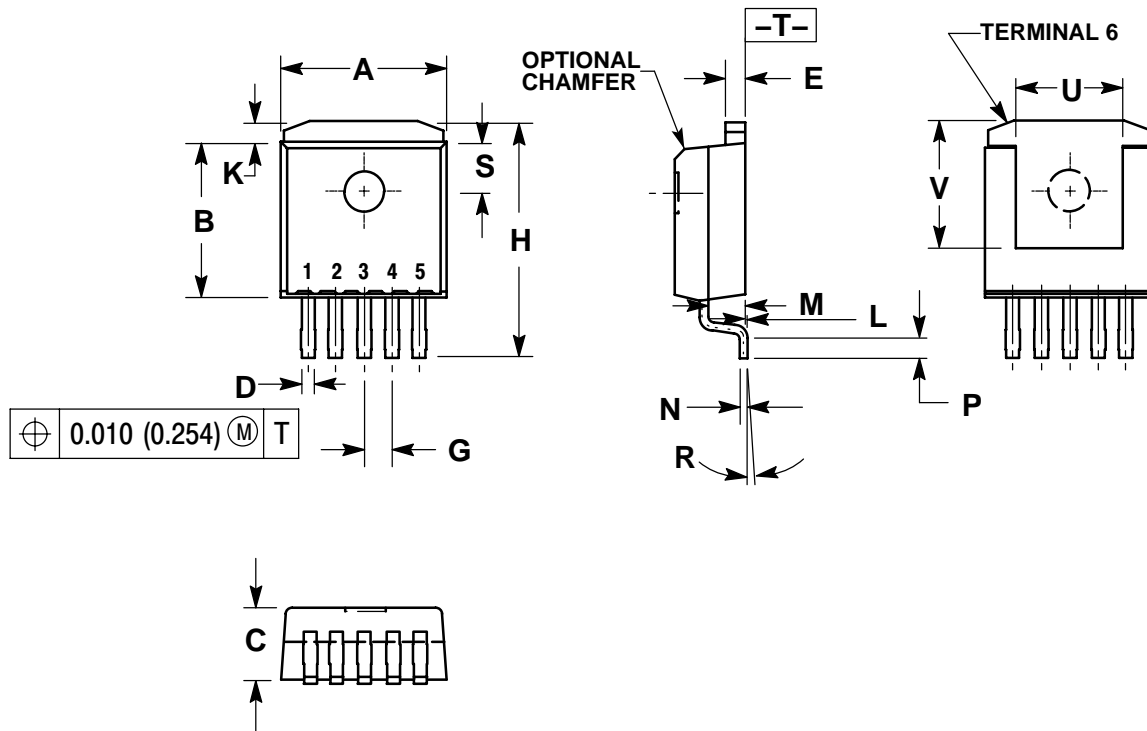

DIM	INCHES		MILLIMETERS	
	MIN	MAX	MIN	MAX
A	0.386	0.403	9.804	10.236
B	0.356	0.368	9.042	9.347
C	0.170	0.180	4.318	4.572
D	0.026	0.036	0.660	0.914
E	0.045	0.055	1.143	1.397
G	0.067 BSC		1.702 BSC	
H	0.539	0.579	13.691	14.707
K	0.050 REF		1.270 REF	
L	0.000	0.010	0.000	0.254
M	0.088	0.102	2.235	2.591
N	0.018	0.026	0.457	0.660
P	0.058	0.078	1.473	1.981
R	5° REF		5° REF	
S	0.116 REF		2.946 REF	
U	0.200 MIN		5.080 MIN	
V	0.250 MIN		6.350 MIN	



Attention

- Any and all HUA XUAN YANG ELECTRONICS products described or contained herein do not have specifications that can handle applications that require extremely high levels of reliability, such as life-support systems, aircraft's control systems, or other applications whose failure can be reasonably expected to result in serious physical and/or material damage. Consult with your HUA XUAN YANG ELECTRONICS representative nearest you before using any HUA XUAN YANG ELECTRONICS products described or contained herein in such applications.
- HUA XUAN YANG ELECTRONICS assumes no responsibility for equipment failures that result from using products at values that exceed, even momentarily, rated values (such as maximum ratings, operating condition ranges, or other parameters) listed in products specifications of any and all HUA XUAN YANG ELECTRONICS products described or contained herein.
- Specifications of any and all HUA XUAN YANG ELECTRONICS products described or contained herein stipulate the performance, characteristics, and functions of the described products in the independent state, and are not guarantees of the performance, characteristics, and functions of the described products as mounted in the customer's products or equipment. To verify symptoms and states that cannot be evaluated in an independent device, the customer should always evaluate and test devices mounted in the customer's products or equipment.
- HUA XUAN YANG ELECTRONICS CO.,LTD. strives to supply high-quality high-reliability products. However, any and all semiconductor products fail with some probability. It is possible that these probabilistic failures could give rise to accidents or events that could endanger human lives, that could give rise to smoke or fire, or that could cause damage to other property. When designing equipment, adopt safety measures so that these kinds of accidents or events cannot occur. Such measures include but are not limited to protective circuits and error prevention circuits for safe design, redundant design, and structural design.
- In the event that any or all HUA XUAN YANG ELECTRONICS products(including technical data, services) described or contained herein are controlled under any of applicable local export control laws and regulations, such products must not be exported without obtaining the export license from the authorities concerned in accordance with the above law.
- No part of this publication may be reproduced or transmitted in any form or by any means, electronic or mechanical, including photocopying and recording, or any information storage or retrieval system, or otherwise, without the prior written permission of HUA XUAN YANG ELECTRONICS CO.,LTD.
- Information (including circuit diagrams and circuit parameters) herein is for example only ; it is not guaranteed for volume production. HUA XUAN YANG ELECTRONICS believes information herein is accurate and reliable, but no guarantees are made or implied regarding its use or any infringements of intellectual property rights or other rights of third parties.
- Any and all information described or contained herein are subject to change without notice due to product/technology improvement, etc. When designing equipment, refer to the "Delivery Specification" for the HUA XUAN YANG ELECTRONICS product that you intend to use.