

PART NUMBER	DESCRIPTION
CCS-18	Commercial Normally Open Multi-throw, DC-12GHz
CS-18	Elite Normally Open Multi-throw, DC-12GHz

The CCS-18/CS-18 is a broadband multi-position coaxial switch designed to switch RF signals from one input port to any one of 3 through 8 output ports. It is readily adapted to any 50 Ohms transmission line system. The standard actuator gives individual solenoid control of each position and when de-energized, all positions are open. Standard actuator voltage is 28 VDC. The primary advantage of this switch over the miniature versions shown on previous pages is the higher power handling capability.



ENVIRONMENTAL AND PHYSICAL CHARACTERISTICS	
Operating Temperature	
Commercial Model, CCS-18	-40°C to 65°C
Elite Model, CS-18	-55°C to 85°C
Vibration (MIL-STD-202 Method 214, Condition D, non-operating)	10 g's RMS
Shock (MIL-STD-202 Method 213, Condition D, non-operating)	500 g's
Standard Actuator Life	3,000,000 cycles
Actuator Life w/ Additional Features	1,000,000 cycles
Connector Type	Type N or TNC
Humidity (Moisture Seal)	Available
Weight	9 oz. (255.2g) (max.)

ELECTRICAL CHARACTERISTICS	
Form Factor	Multi-Throw, break before make
Frequency Range	
CCS-18	DC-12 GHz
CS-18	DC-12 GHz
Characteristic Impedance	50 Ohms
Operate Time	10 ms (max.)
Release Time	10 ms (max.)
Actuation Voltage Available	12 15 24 28 V
Actuation Current, max. @ ambient	600 700 230 270 mA

TYPICAL PERFORMANCE CHARACTERISTICS: N CONNECTOR OPTION (TNC CONNECTOR, 11GHz MAX.)				
Frequency	DC-3 GHz	3-6 GHz	6-9 GHz	9-12 GHz
Insertion Loss, dB, typical.	0.2	0.2	0.3	0.4
Isolation, dB, typical.	80	80	80	75
VSWR, typical.	1.3:1	1.3:1	1.5:1	1.7:1

For maximum limits, please see charts on page 8-10

PART NUMBERING SYSTEM

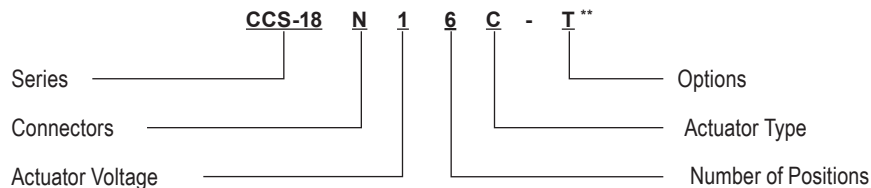

CONNECTOR	ACTUATOR VOLTAGE	NUMBER OF POSITIONS	ACTUATOR TYPE	OPTIONS
N: TYPE N FEMALE	1: 28 VDC NORMALLY OPEN	3: SP3T	0: NO INDICATOR CONTACTS	T: TTL DRIVERS WITH DIODES
T: TNC FEMALE	2: 15 VDC NORMALLY OPEN	4: SP4T	C: INDICATOR CONTACTS	D: COIL TRANSIENT SUPPRESSION DIODES
	3: 12 VDC NORMALLY OPEN	5: SP5T		S: D-SUB CONNECTOR*
HN: HIGH POWER TYPE N FEMALE	4: 24 VDC NORMALLY OPEN	6: SP6T		TD: DECODERS AND TTL DRIVERS WITH DIODES
		7: SP7T		M: MOISTURE SEAL
HT: HIGH POWER TNC FEMALE		8: SP8T		

**SEE PARTS LIST ON PAGE 13-20

For additional options, please contact factory.

* D-Sub Connector may be 9 or 15 pin depending on number of throws. (See Connector Pinout page)

Series CCS-18/CS-18

High Power Multi-Throw DC-12 GHz
Normally Open Coaxial Switch



SCHEMATICS AND MECHANICAL OUTLINE FOR SP3T-SP6T SWITCHES

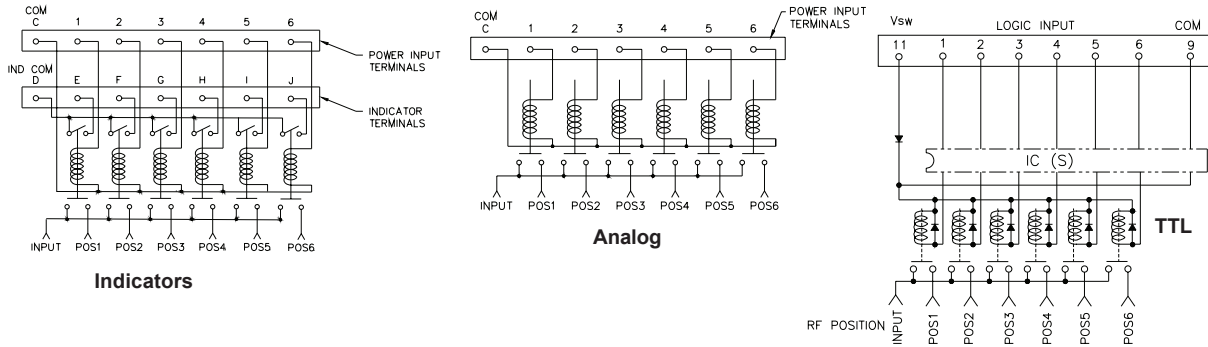

Indicators

Analog

TTL

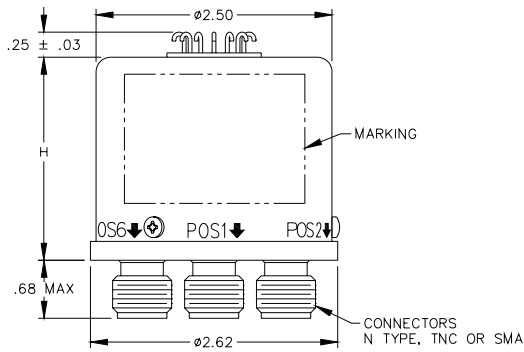
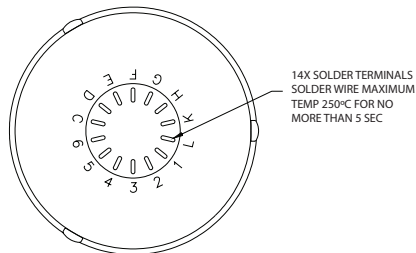

SP3T - SP6T H = 2.15 STD & Indicator Model
SP3T - SP6T H = 2.65 All OTHER Models

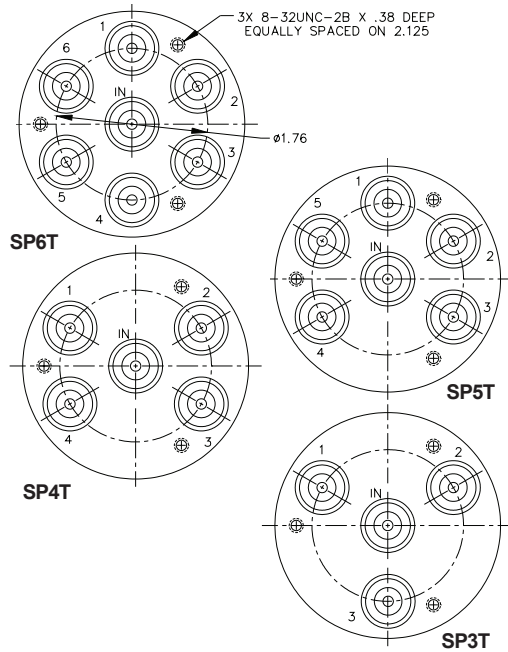

MECHANICAL OUTLINE FOR SP7T & SP8T SWITCHES

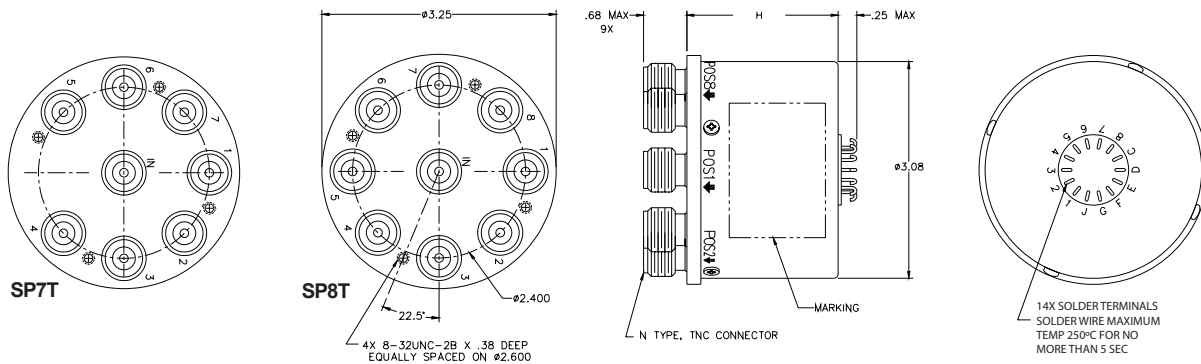

SP7T & SP8T H = 2.15 STD Model
SP7T & SP8T H = 2.65 All OTHER Models

“-s OPTION” 9-PIN D-SUB OR 15-PIN D-MICRO CONNECTOR (EXAMPLE: CCS-18N160-S)

CONNECTOR PINOUT FOR NORMALLY OPEN SP3T MULTI-THROW SWITCHES						
EXAMPLE	CR-18S130-S	CR-18S13C-S	CR-18S130-TS	CR-18S13C-TS	CR-18S130-TDS	CR-18S13C-TDS
PIN NO	2706650 9-PINS	2706650 9-PINS	2706650 9-PINS	2706650 9-PINS	2706650 9-PINS	2706650 9-PINS
INDICATOR		YES		YES		YES
TTL			YES	YES		
DECODERS & TTL					YES	YES
1	PORT 1	PORT 1	TTL 1	TTL 1	LOGIC 1	LOGIC 1
2	PORT 2	PORT 3	TTL 2	TTL 2	LOGIC 2	LOGIC 2
3	PORT 3	PORT 3	TTL 3	TTL 3		
4		E INDICATOR		E INDICATOR		E INDICATOR
5		F INDICATOR		F INDICATOR		F INDICATOR
6		G INDICATOR		G INDICATOR		G INDICATOR
7	COMMON	COMMON	COMMON	COMMON	COMMON	COMMON
8			V _{sw}	V _{sw}	V _{sw}	V _{sw}
9		D INDICATOR (COM)		D INDICATOR (COM)		D INDICATOR (COM)

CONNECTOR PINOUT FOR NORMALLY OPEN SP4T MULTI-THROW SWITCHES						
EXAMPLE	CR-18S140-S	CR-18S14C-S	CR-18S140-TS	CR-18S14C-TS	CR-18S140-TDS	CR-18S14C-TDS
PIN NO	2706650 9-PINS	C00-166-4 (CCR) 2707572 (CCT)	2706650 9-PINS	C00-166-4 (CCR) 2707572 (CCT)	2706650 9-PINS	C00-166-4 (CCR) 2707572 (CCT)
INDICATOR		YES		YES		YES
TTL			YES	YES		
DECODERS & TTL					YES	YES
1	PORT 1	PORT 1	TTL 1	TTL 1	LOGIC 1	LOGIC 1
2	PORT 2	PORT 3	TTL 2	TTL 2	LOGIC 2	LOGIC 2
3	PORT 3	PORT 3	TTL 3	TTL 3	LOGIC 3	LOGIC 3
4	PORT 4	PORT 4	TTL 4	TTL 4		
5						
6						
7	COMMON	COMMON	COMMON	COMMON	COMMON	COMMON
8			V _{sw}	V _{sw}	V _{sw}	V _{sw}
9		D INDICATOR (COM)		D INDICATOR (COM)		D INDICATOR (COM)
10		E INDICATOR		E INDICATOR		E INDICATOR
11		F INDICATOR		F INDICATOR		F INDICATOR
12		G INDICATOR		G INDICATOR		G INDICATOR
13		H INDICATOR		H INDICATOR		H INDICATOR
14						
15						

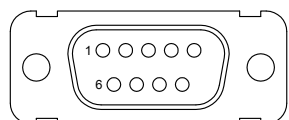

9-PIN D-SUB CONNECTOR

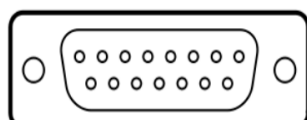

15-PIN D-SUB CONNECTOR

Series CCS-18/CS-18
High Power Multi-Throw DC–12 GHz
Normally Open Coaxial Switch



CONNECTOR PINOUT FOR NORMALLY OPEN SP5T MULTI-THROW SWITCHES						
EXAMPLE	CR-18S150-S	CR-18S15C-S	CR-18S150-TS	CR-18S15C-TS	CR-18S150-TDS	CR-18S15C-TDS
PIN NO	2706650 9-PINS	C00-166-4 (CCR) 2707572 (CCT)	2706650 9-PINS	C00-166-4 (CCR) 2707572 (CCT)	2706650 9-PINS	C00-166-4 (CCR) 2707572 (CCT)
INDICATOR		YES		YES		YES
TTL			YES	YES		
DECODERS & TTL					YES	YES
1	PORT 1	PORT 1	TTL 1	TTL 1	LOGIC 1	LOGIC 1
2	PORT 2	PORT 3	TTL 2	TTL 2	LOGIC 2	LOGIC 2
3	PORT 3	PORT 3	TTL 3	TTL 3	LOGIC 3	LOGIC 3
4	PORT 4	PORT 4	TTL 4	TTL 4		
5	PORT 5	PORT 5	TTL 5	TTL 5		
6						
7	COMMON	COMMON	COMMON	COMMON	COMMON	COMMON
8			V _{sw}	V _{sw}	V _{sw}	V _{sw}
9		D INDICATOR (COM)		D INDICATOR (COM)		D INDICATOR (COM)
10		E INDICATOR		E INDICATOR		E INDICATOR
11		F INDICATOR		F INDICATOR		F INDICATOR
12		G INDICATOR		G INDICATOR		G INDICATOR
13		H INDICATOR		H INDICATOR		H INDICATOR
14		K INDICATOR		K INDICATOR		K INDICATOR
15						

CONNECTOR PINOUT FOR NORMALLY OPEN SP6T MULTI-THROW SWITCHES						
EXAMPLE	CR-18S160-S	CR-18S16C-S	CR-18S160-TS	CR-18S16C-TS	CR-18S160-TDS	CR-18S16C-TDS
PIN NO	2706650 9-PINS	C00-166-4 (CCR) 2707572 (CCT)	2706650 9-PINS	C00-166-4 (CCR) 2707572 (CCT)	2706650 9-PINS	C00-166-4 (CCR) 2707572 (CCT)
INDICATOR		YES		YES		YES
TTL			YES	YES		
DECODERS & TTL					YES	YES
1	PORT 1	PORT 1	TTL 1	TTL 1	LOGIC 1	LOGIC 1
2	PORT 2	PORT 3	TTL 2	TTL 2	LOGIC 2	LOGIC 2
3	PORT 3	PORT 3	TTL 3	TTL 3	LOGIC 3	LOGIC 3
4	PORT 4	PORT 4	TTL 4	TTL 4		
5	PORT 5	PORT 5	TTL 5	TTL 5		
6	PORT 6	PORT 6	TTL 6	TTL 6		
7	COMMON	COMMON	COMMON	COMMON	COMMON	COMMON
8			V _{sw}	V _{sw}	V _{sw}	V _{sw}
9		D INDICATOR (COM)		D INDICATOR (COM)		D INDICATOR (COM)
10		E INDICATOR		E INDICATOR		E INDICATOR
11		F INDICATOR		F INDICATOR		F INDICATOR
12		G INDICATOR		G INDICATOR		G INDICATOR
13		H INDICATOR		H INDICATOR		H INDICATOR
14		K INDICATOR		K INDICATOR		K INDICATOR
15		L INDICATOR		L INDICATOR		L INDICATOR

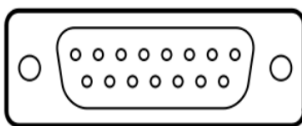

15-PIN D-SUB CONNECTOR

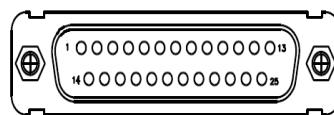

25-PIN D-SUB CONNECTOR

CONNECTOR PINOUT FOR NORMALLY OPEN SP7T MULTI-THROW SWITCHES						
EXAMPLE	CR-18S170-S	CR-18S17C-S	CR-18S170-TS	CR-18S17C-TS	CR-18S170-TDS	CR-18S17C-TDS
PIN NO	2707572 15-PINS	25-PINS	2707572 15-PINS	25-PINS	2707572 15-PINS	25-PINS
INDICATOR		YES		YES		YES
TTL			YES	YES		
DECODERS & TTL					YES	YES
1	PORT 1	PORT 1	TTL 1	TTL 1	LOGIC 1	LOGIC 1
2	PORT 2	PORT 3	TTL 2	TTL 2	LOGIC 2	LOGIC 2
3	PORT 3	PORT 3	TTL 3	TTL 3	LOGIC 3	LOGIC 3
4	PORT 4	PORT 4	TTL 4	TTL 4		
5	PORT 5	PORT 5	TTL 5	TTL 5	COMMON	
6	PORT 6	PORT 6	TTL 6	TTL 6	Vsw	
7	PORT 7	PORT 7	TTL 7	TTL 7		
8						
9						
10						
11			Vsw	Vsw	Vsw	Vsw
12						
13	COMMON	COMMON	COMMON	COMMON	COMMON	COMMON
14						
15		D INDICATOR (COM)		D INDICATOR (COM)		D INDICATOR (COM)
16		E INDICATOR		E INDICATOR		E INDICATOR
17		F INDICATOR		F INDICATOR		F INDICATOR
18		G INDICATOR		G INDICATOR		G INDICATOR
19		H INDICATOR		H INDICATOR		H INDICATOR
20		K INDICATOR		K INDICATOR		K INDICATOR
21		L INDICATOR		L INDICATOR		L INDICATOR
22		M INDICATOR		M INDICATOR		M INDICATOR
23						
24						
25						

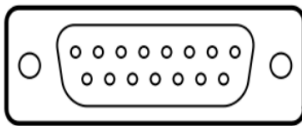

15-PIN D-SUB CONNECTOR

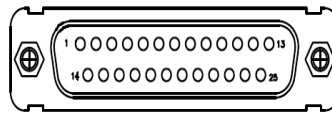

25-PIN D-SUB CONNECTOR

Series CCS-18/CS-18
High Power Multi-Throw DC–12 GHz
Normally Open Coaxial Switch



CONNECTOR PINOUT FOR NORMALLY OPEN SP8T MULTI-THROW SWITCHES						
EXAMPLE	CR-18S180-S	CR-18S18C-S	CR-18S180-TS	CR-18S18C-TS	CR-18S180-TDS	CR-18S18C-TDS
PIN NO	2707572 15-PINS	25-PINS	2707572 15-PINS	25-PINS	2707572 15-PINS	25-PINS
INDICATOR		YES		YES		YES
TTL			YES	YES		
DECODERS & TTL					YES	YES
1	PORT 1	PORT 1	TTL 1	TTL 1	LOGIC 1	LOGIC 1
2	PORT 2	PORT 3	TTL 2	TTL 2	LOGIC 2	LOGIC 2
3	PORT 3	PORT 3	TTL 3	TTL 3	LOGIC 3	LOGIC 3
4	PORT 4	PORT 4	TTL 4	TTL 4	LOGIC 4	LOGIC 4
5	PORT 5	PORT 5	TTL 5	TTL 5		
6	PORT 6	PORT 6	TTL 6	TTL 6		
7	PORT 7	PORT 7	TTL 7	TTL 7		
8	PORT 8	PORT 8	TTL 8	TTL 8		
9						
10						
11			Vsw	Vsw	Vsw	Vsw
12						
13	COMMON	COMMON	COMMON	COMMON	COMMON	COMMON
14						
15		D INDICATOR (COM)		D INDICATOR (COM)		D INDICATOR (COM)
16		E INDICATOR		E INDICATOR		E INDICATOR
17		F INDICATOR		F INDICATOR		F INDICATOR
18		G INDICATOR		G INDICATOR		G INDICATOR
19		H INDICATOR		H INDICATOR		H INDICATOR
20		K INDICATOR		K INDICATOR		K INDICATOR
21		L INDICATOR		L INDICATOR		L INDICATOR
22		M INDICATOR		M INDICATOR		M INDICATOR
23		N INDICATOR		N INDICATOR		N INDICATOR
24						
25						

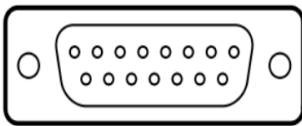

15-PIN D-SUB CONNECTOR

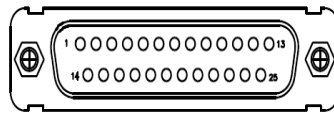

25-PIN D-SUB CONNECTOR

TRUTH TABLE Normally Open
CCS-18NX3C-T

Logic Input			RF Path			Indicator Switches		
1	2	3	J1	J2	J3	E	F	G
1	0	0	On	Off	Off	C	0	0
0	1	0	Off	On	Off	0	C	0
0	0	1	Off	Off	On	0	0	C

TRUTH TABLE Normally Open
CCS-18NX3C-TD

Logic Input		RF Path			Indicator Switches		
1	2	J1	J2	J3	E	F	G
0	0	On	Off	Off	C	0	0
1	0	Off	On	Off	0	C	0
0	1	Off	Off	On	0	0	C
1	1	Off	Off	Off	0	0	0

TRUTH TABLE Normally Open
CCS-18NX4C-T

Logic Input				RF Path				Indicator Switches			
1	2	3	4	J1	J2	J3	J4	E	F	G	H
1	0	0	0	On	Off	Off	Off	C	0	0	0
0	1	0	0	Off	On	Off	Off	0	C	0	0
0	0	1	0	Off	Off	On	Off	0	0	C	0
0	0	0	1	Off	Off	Off	On	0	0	0	C

TRUTH TABLE Normally Open
CCS-18NX4C-TD

Logic Input			RF Path				Indicator Switches			
1	2	3	J1	J2	J3	J4	E	F	G	H
0	0	0	On	Off	Off	Off	C	0	0	0
1	0	0	Off	On	Off	Off	0	C	0	0
0	1	0	Off	Off	On	Off	0	0	C	0
1	1	0	Off	Off	Off	On	0	0	0	C
1	1	1	Off	Off	Off	Off	0	0	0	0

Series CCS-18/CS-18

High Power Multi-Throw DC–12 GHz
Normally Open Coaxial Switch



TRUTH TABLE Normally Open CCS-18NX5C-T

Logic Input					RF Path					Indicator Switches				
1	2	3	4	5	J1	J2	J3	J4	J5	E	F	G	H	K
1	0	0	0	0	On	Off	Off	Off	Off	C	0	0	0	0
0	1	0	0	0	Off	On	Off	Off	Off	0	C	0	0	0
0	0	1	0	0	Off	Off	On	Off	Off	0	0	C	0	0
0	0	0	1	0	Off	Off	Off	On	Off	0	0	0	C	0
0	0	0	0	1	Off	Off	Off	Off	On	0	0	0	0	C

TRUTH TABLE Normally Open CCS-18NX5C-TD

Logic Input			RF Path					Indicator Switches				
1	2	3	J1	J2	J3	J4	J5	E	F	G	H	K
0	0	0	On	Off	Off	Off	Off	C	0	0	0	0
1	0	0	Off	On	Off	Off	Off	0	C	0	0	0
0	1	0	Off	Off	On	Off	Off	0	0	C	0	0
1	1	0	Off	Off	Off	On	Off	0	0	0	C	0
0	0	1	Off	Off	Off	Off	On	0	0	0	0	C
1	1	1	Off	Off	Off	Off	Off	0	0	0	0	0

TRUTH TABLE Normally Open CCS-18NX6C-T

Logic Input						RF Path						Indicator Switches					
1	2	3	4	5	6	J1	J2	J3	J4	J5	J6	E	F	G	H	K	L
1	0	0	0	0	0	On	Off	Off	Off	Off	Off	C	0	0	0	0	0
0	1	0	0	0	0	Off	On	Off	Off	Off	Off	0	C	0	0	0	0
0	0	1	0	0	0	Off	Off	On	Off	Off	Off	0	0	C	0	0	0
0	0	0	1	0	0	Off	Off	Off	On	Off	Off	0	0	0	C	0	0
0	0	0	0	1	0	Off	Off	Off	Off	On	Off	0	0	0	0	C	0
0	0	0	0	0	1	Off	Off	Off	Off	Off	On	0	0	0	0	0	C

TRUTH TABLE Normally Open CCS-18NX6C-TD

Logic Input			RF Path						Indicator Switches					
1	2	3	J1	J2	J3	J4	J5	J6	E	F	G	H	K	L
0	0	0	On	Off	Off	Off	Off	Off	C	0	0	0	0	0
1	0	0	Off	On	Off	Off	Off	Off	0	C	0	0	0	0
0	1	0	Off	Off	On	Off	Off	Off	0	0	C	0	0	0
1	1	0	Off	Off	Off	On	Off	Off	0	0	0	C	0	0
0	0	1	Off	Off	Off	Off	On	Off	0	0	0	0	C	0
1	0	1	Off	Off	Off	Off	Off	On	0	0	0	0	0	C
1	1	1	Off	Off	Off	Off	Off	Off	0	0	0	0	0	0

**TRUTH TABLE Normally Open
CCS-18NX7C-T**

Logic Input							RF Path							Indicator Switches						
1	2	3	4	5	6	7	J1	J2	J3	J4	J5	J6	J7	E	F	G	H	K	L	M
1	0	0	0	0	0	0	On	Off	Off	Off	Off	Off	Off	C	0	0	0	0	0	0
0	1	0	0	0	0	0	Off	On	Off	Off	Off	Off	Off	0	C	0	0	0	0	0
0	0	1	0	0	0	0	Off	Off	On	Off	Off	Off	Off	0	0	C	0	0	0	0
0	0	0	1	0	0	0	Off	Off	Off	On	Off	Off	Off	0	0	0	C	0	0	0
0	0	0	0	1	0	0	Off	Off	Off	Off	On	Off	Off	0	0	0	0	C	0	0
0	0	0	0	0	1	0	Off	Off	Off	Off	Off	On	Off	0	0	0	0	0	C	0
0	0	0	0	0	0	1	Off	Off	Off	Off	Off	Off	On	0	0	0	0	0	0	C

**TRUTH TABLE Normally Open
CCS-18NX7C-TD**

Logic Input			RF Path							Indicator Switches						
1	2	3	J1	J2	J3	J4	J5	J6	J7	E	F	G	H	K	L	M
0	0	0	On	Off	Off	Off	Off	Off	Off	C	0	0	0	0	0	0
1	0	0	Off	On	Off	Off	Off	Off	Off	0	C	0	0	0	0	0
0	1	0	Off	Off	On	Off	Off	Off	Off	0	0	C	0	0	0	0
1	1	0	Off	Off	Off	On	Off	Off	Off	0	0	0	C	0	0	0
0	0	1	Off	Off	Off	Off	On	Off	Off	0	0	0	0	C	0	0
1	0	1	Off	Off	Off	Off	Off	On	Off	0	0	0	0	0	C	0
0	1	1	Off	Off	Off	Off	Off	Off	On	0	0	0	0	0	0	C
1	1	1	Off	Off	Off	Off	Off	Off	Off	0	0	0	0	0	0	0

**TRUTH TABLE Normally Open
CCS-18NX8C-T**

Logic Input								RF Path								Indicator Switches							
1	2	3	4	5	6	7	8	J1	J2	J3	J4	J5	J6	J7	J8	E	F	G	H	K	L	M	N
1	0	0	0	0	0	0	0	On	Off	Off	Off	Off	Off	Off	Off	C	0	0	0	0	0	0	0
0	1	0	0	0	0	0	0	Off	On	Off	Off	Off	Off	Off	Off	0	C	0	0	0	0	0	0
0	0	1	0	0	0	0	0	Off	Off	On	Off	Off	Off	Off	Off	0	0	C	0	0	0	0	0
0	0	0	1	0	0	0	0	Off	Off	Off	On	Off	Off	Off	Off	0	0	0	C	0	0	0	0
0	0	0	0	1	0	0	0	Off	Off	Off	Off	On	Off	Off	Off	0	0	0	0	C	0	0	0
0	0	0	0	0	1	0	0	Off	Off	Off	Off	Off	On	Off	Off	0	0	0	0	0	C	0	0
0	0	0	0	0	0	1	0	Off	Off	Off	Off	Off	Off	On	Off	0	0	0	0	0	0	C	0
0	0	0	0	0	0	0	1	Off	Off	Off	Off	Off	Off	Off	On	0	0	0	0	0	0	0	C

**TRUTH TABLE Normally Open
CCS-18NX8C-TD**

Logic Input				RF Path								Indicator Switches							
1	2	3	4	J1	J2	J3	J4	J5	J6	J7	J8	E	F	G	H	K	L	M	N
0	0	0	0	On	Off	Off	Off	Off	Off	Off	Off	C	0	0	0	0	0	0	0
1	0	0	0	Off	On	Off	Off	Off	Off	Off	Off	0	C	0	0	0	0	0	0
0	1	0	0	Off	Off	On	Off	Off	Off	Off	Off	0	0	C	0	0	0	0	0
1	1	0	0	Off	Off	Off	On	Off	Off	Off	Off	0	0	0	C	0	0	0	0
0	0	1	0	Off	Off	Off	Off	On	Off	Off	Off	0	0	0	0	C	0	0	0
1	0	1	0	Off	Off	Off	Off	Off	On	Off	Off	0	0	0	0	0	C	0	0
0	1	1	0	Off	Off	Off	Off	Off	Off	On	Off	0	0	0	0	0	0	C	0
1	1	1	1	Off	Off	Off	Off	Off	Off	Off	On	0	0	0	0	0	0	0	C
1	1	1	0	Off	Off	Off	Off	Off	Off	Off	Off	0	0	0	0	0	0	0	0

TYPICAL NARROWBAND RF INSERTION LOSS PERFORMANCE CURVES

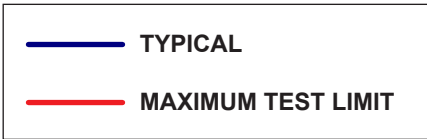
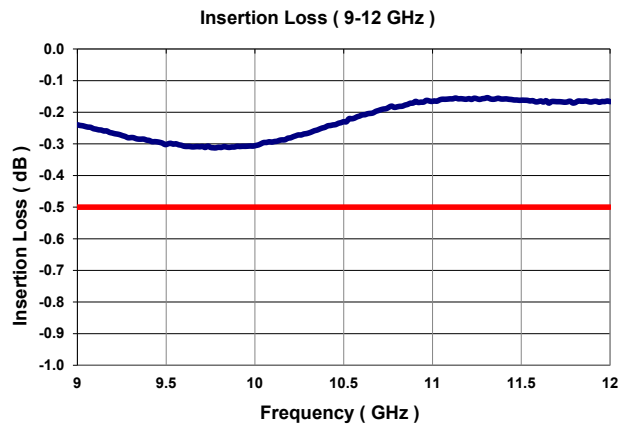
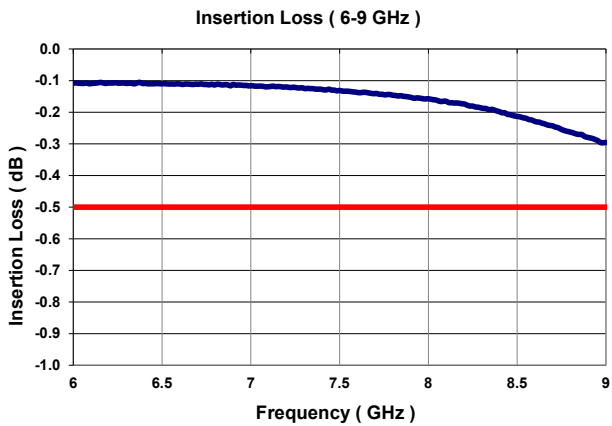
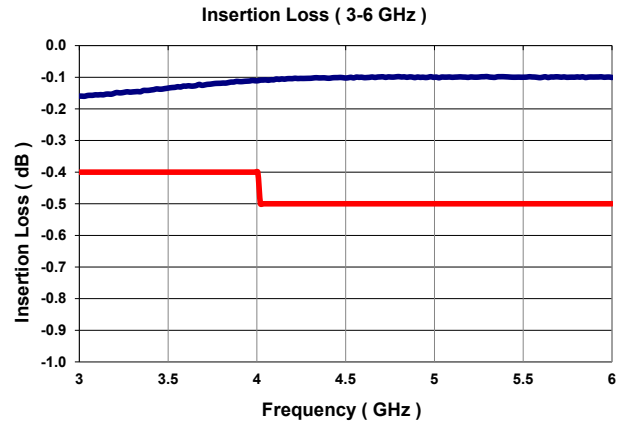
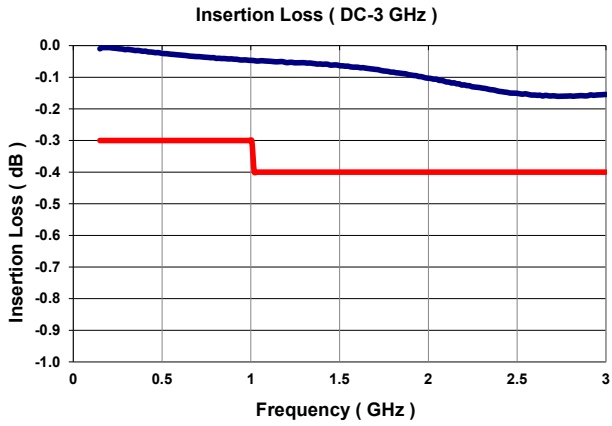

TYPICAL NARROWBAND RF ISOLATION PERFORMANCE CURVES

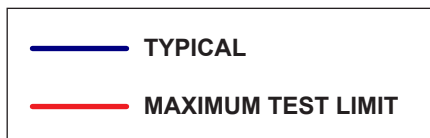
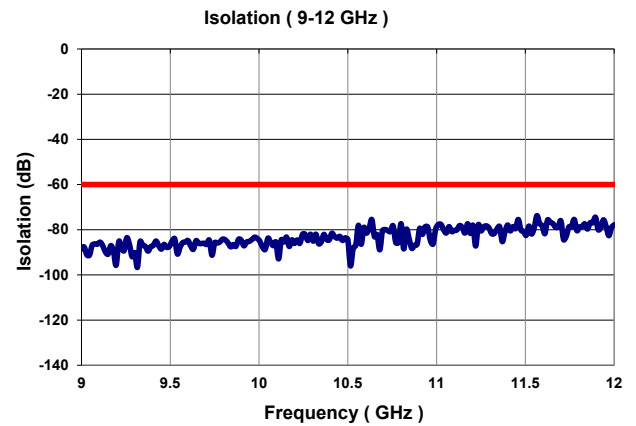
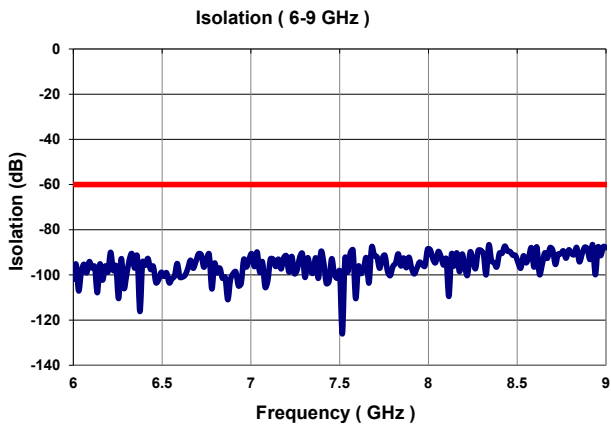
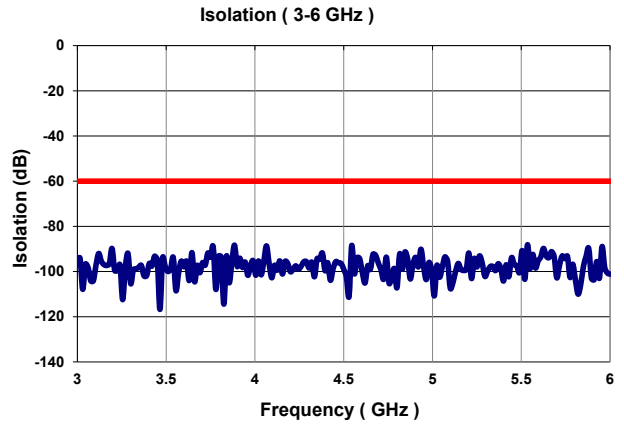
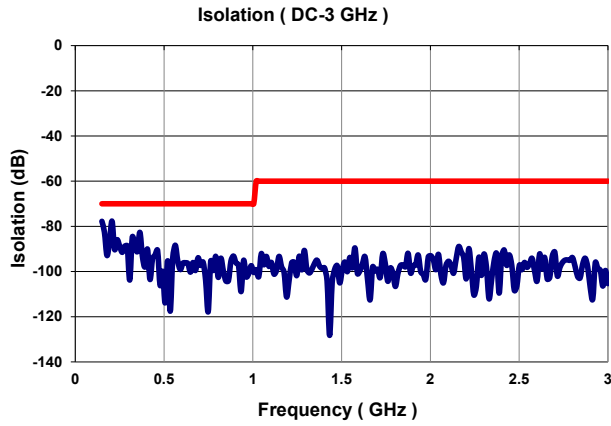

TYPICAL NARROWBAND RF VSWR PERFORMANCE CURVES

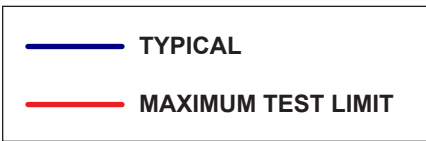
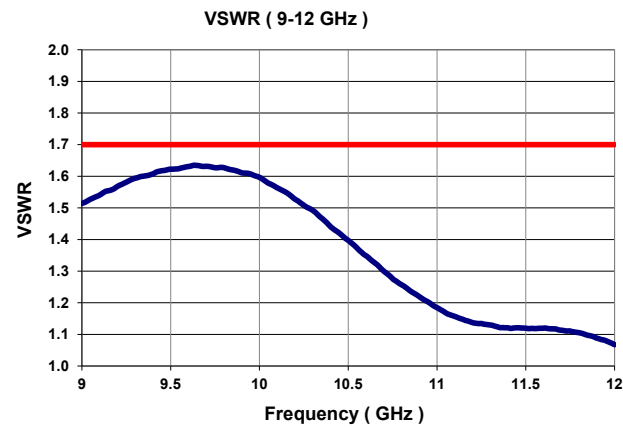
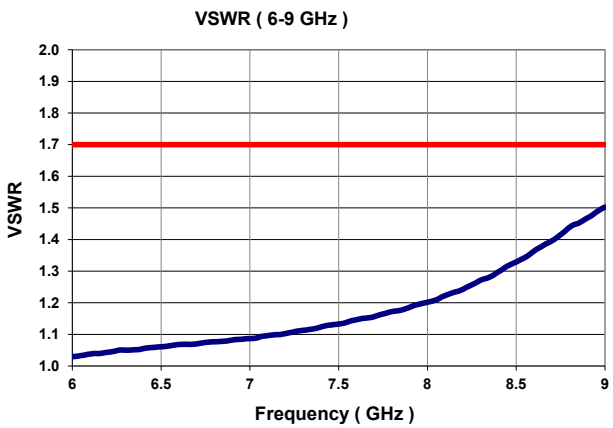
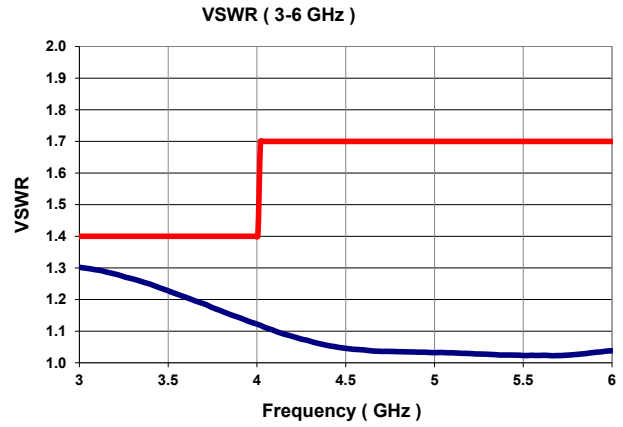
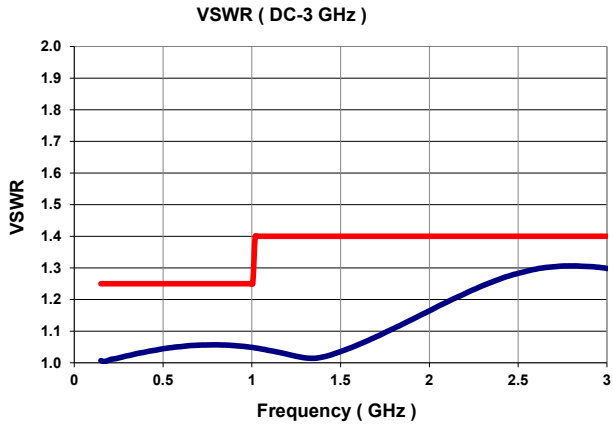

TYPICAL POWER PERFORMANCE CURVE

Power Handling vs. Frequency

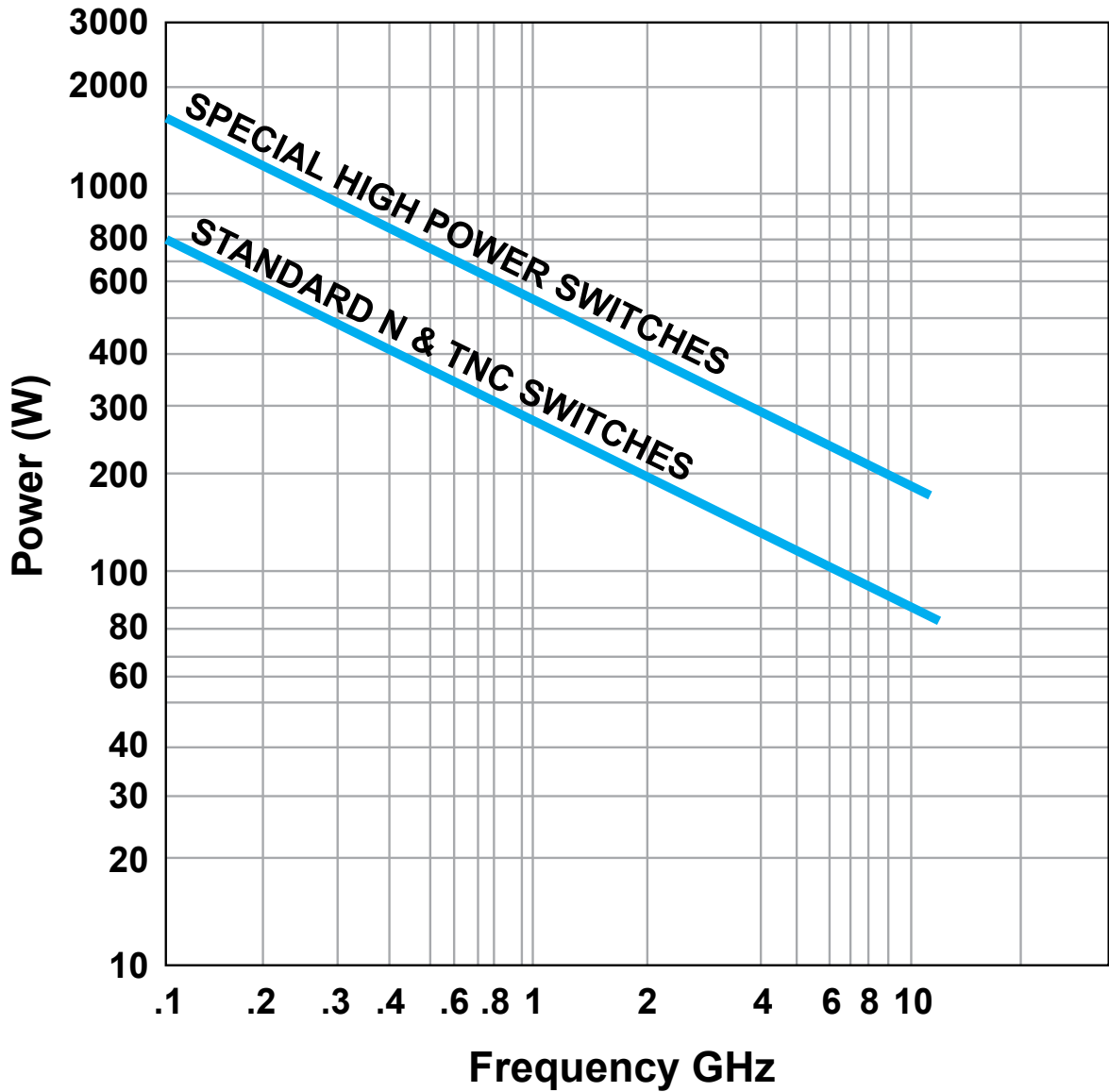

Estimates based on the following reference conditions:

- Ambient temperature of 40°C or less
- Sea level operation
- Load VSWR of 1.20:1 maximum
- No high-power (hot) switching

Please contact Teledyne Coax Switches for derating factors when applications do not meet the foregoing reference conditions.

GLOSSARY

Actuator

An actuator is the electromechanical mechanism that transfers the RF contacts from one position to another upon DC command.

Arc Suppression Diode

A diode is connected in parallel with the coil. This diode limits the “reverse EMF spike” generated when the coil de-energizes to 0.7 volts. The diode cathode is connected to the positive side of the coil and the anode is connected to the negative side.

Date Code

All switches are marked with either a unique serial number or a date code. Date codes are in accordance with MIL-STD-1285 Paragraph 5.2.5 and consist of four digits. The first two digits define the year and the last two digits define the week of the year (YYWW). Thus, 1032 identifies switches that passed through final inspection during the 32nd week of 2010.

Indicator

Indicators tell the system which position the switch is in. Other names for indicators are telemetry contacts or tellback circuit. Indicators are usually a set of internally mounted DC contacts linked to the actuator. They can be wired to digital input lines, status lights, or interlocks. Unless otherwise specified, the maximum indicator contact rating is 30 Vdc, 50 mA, or 1.5 Watts into a resistive load.

Isolation

Isolation is the measure of the power level at the output connector of an unconnected RF channel as referenced to the power at the input connector. It is specified in dB below the input power level.

Multi-Throw Switch

A multi-throw switch is a switch with one input and three or more output ports. The CCS-18 can switch a microwave signal to any of 2,3,4,5 or 6 output from a single common input.

Switching Time

Switching time is the total interval beginning with the arrival of the leading edge of the command pulse at the switch DC input and ending with the completion of the switch transfer, including contact bounce. It consists of three parts: (1) inductive delay in the coil, (2) transfer time of the physical movement of the contacts, and (3) the bounce time of the RF contacts.

TTL Switch Driver Option

As a special option, switch drivers can be provided for both failsafe and latching switches, which are compatible with industry-standard low-power Schottky TTL circuits.

TD-Option

This option includes a decoder. The 3-bit parallel command is decoded to internally select the appropriate position. See the logic tables. The TD-Option increases the Vsw supply current demand by 50mA max at 28Vdc and +20°C.

Performance Parameters vs Frequency

Generally speaking, the RF performance of coaxial switches is frequency dependent. With increasing frequency, VSWR and insertion loss increase while isolation decreases. All data sheets specify these three parameters as “worst case” at the highest operating frequency. If the switch is to be used over a narrow frequency band, better performance can be achieved.

Actuator Current vs Temperature

The resistance of the actuator coil varies as a function of temperature. There is an inverse relationship between the operating temperature of the switch and the actuator drive current. For switches operating at 28 VDC, the approximate actuator drive current at temperature, T, can be calculated using the equation:

$$I_T = \frac{I_A}{[1 + .00385 (T-20)]}$$

Where:

I_T = Actuator current at temperature, T

I_A = Room temperature actuator current – see data sheet

T = Temperature of interest in °C

Magnetic Sensitivity

An electro-mechanical switch can be sensitive to ferrous materials and external magnetic fields. Neighboring ferrous materials should be permitted no closer than 0.5 inches and adjacent external magnetic fields should be limited to a flux density of less than 5 Gauss.

NORMALLY OPEN CCS-18N/CS-18N • CCS-18T/CS-18T PART NUMBER LIST

	PART No.		PART No.		PART No.		PART No.
1	CCS-18NX3C	43	CS-18NX30	85	CS-18NX4C	127	CCS-18NX50
2	CCS-18NX3C-D	44	CS-18NX30-D	86	CS-18NX4C-D	128	CCS-18NX50-D
3	CCS-18NX3C-DM	45	CS-18NX30-DM	87	CS-18NX4C-DM	129	CCS-18NX50-DM
4	CCS-18NX3C-M	46	CS-18NX30-M	88	CS-18NX4C-M	130	CCS-18NX50-M
5	CCS-18NX3C-MS	47	CS-18NX30-MS	89	CS-18NX4C-MS	131	CCS-18NX50-MS
6	CCS-18NX3C-S	48	CS-18NX30-S	90	CS-18NX4C-S	132	CCS-18NX50-S
7	CCS-18NX3C-T	49	CS-18NX30-T	91	CS-18NX4C-T	133	CCS-18NX50-T
8	CCS-18NX3C-TD	50	CS-18NX30-TD	92	CS-18NX4C-TD	134	CCS-18NX50-TD
9	CCS-18NX3C-TDM	51	CS-18NX30-TDM	93	CS-18NX4C-TDM	135	CCS-18NX50-TDM
10	CCS-18NX3C-TDMS	52	CS-18NX30-TDMS	94	CS-18NX4C-TDMS	136	CCS-18NX50-TDMS
11	CCS-18NX3C-TDS	53	CS-18NX30-TDS	95	CS-18NX4C-TDS	137	CCS-18NX50-TDS
12	CCS-18NX3C-TM	54	CS-18NX30-TM	96	CS-18NX4C-TM	138	CCS-18NX50-TM
13	CCS-18NX3C-TMS	55	CS-18NX30-TMS	97	CS-18NX4C-TMS	139	CCS-18NX50-TMS
14	CCS-18NX3C-TS	56	CS-18NX30-TS	98	CS-18NX4C-TS	140	CCS-18NX50-TS
15	CCS-18NX30	57	CCS-18NX4C	99	CS-18NX40	141	CS-18NX5C
16	CCS-18NX30-D	58	CCS-18NX4C-D	100	CS-18NX40-D	142	CS-18NX5C-D
17	CCS-18NX30-DM	59	CCS-18NX4C-DM	101	CS-18NX40-DM	143	CS-18NX5C-DM
18	CCS-18NX30-M	60	CCS-18NX4C-M	102	CS-18NX40-M	144	CS-18NX5C-M
19	CCS-18NX30-MS	61	CCS-18NX4C-MS	103	CS-18NX40-MS	145	CS-18NX5C-MS
20	CCS-18NX30-S	62	CCS-18NX4C-S	104	CS-18NX40-S	146	CS-18NX5C-S
21	CCS-18NX30-T	63	CCS-18NX4C-T	105	CS-18NX40-T	147	CS-18NX5C-T
22	CCS-18NX30-TD	64	CCS-18NX4C-TD	106	CS-18NX40-TD	148	CS-18NX5C-TD
23	CCS-18NX30-TDM	65	CCS-18NX4C-TDM	107	CS-18NX40-TDM	149	CS-18NX5C-TDM
24	CCS-18NX30-TDMS	66	CCS-18NX4C-TDMS	108	CS-18NX40-TDMS	150	CS-18NX5C-TDMS
25	CCS-18NX30-TDS	67	CCS-18NX4C-TDS	109	CS-18NX40-TDS	151	CS-18NX5C-TDS
26	CCS-18NX30-TM	68	CCS-18NX4C-TM	110	CS-18NX40-TM	152	CS-18NX5C-TM
27	CCS-18NX30-TMS	69	CCS-18NX4C-TMS	111	CS-18NX40-TMS	153	CS-18NX5C-TMS
28	CCS-18NX30-TS	70	CCS-18NX4C-TS	112	CS-18NX40-TS	154	CS-18NX5C-TS
29	CS-18NX3C	71	CCS-18NX40	113	CCS-18NX5C	155	CS-18NX50
30	CS-18NX3C-D	72	CCS-18NX40-D	114	CCS-18NX5C-D	156	CS-18NX50-D
31	CS-18NX3C-DM	73	CCS-18NX40-DM	115	CCS-18NX5C-DM	157	CS-18NX50-DM
32	CS-18NX3C-M	74	CCS-18NX40-M	116	CCS-18NX5C-M	158	CS-18NX50-M
33	CS-18NX3C-MS	75	CCS-18NX40-MS	117	CCS-18NX5C-MS	159	CS-18NX50-MS
34	CS-18NX3C-S	76	CCS-18NX40-S	118	CCS-18NX5C-S	160	CS-18NX50-S
35	CS-18NX3C-T	77	CCS-18NX40-T	119	CCS-18NX5C-T	161	CS-18NX50-T
36	CS-18NX3C-TD	78	CCS-18NX40-TD	120	CCS-18NX5C-TD	162	CS-18NX50-TD
37	CS-18NX3C-TDM	79	CCS-18NX40-TDM	121	CCS-18NX5C-TDM	163	CS-18NX50-TDM
38	CS-18NX3C-TDMS	80	CCS-18NX40-TDMS	122	CCS-18NX5C-TDMS	164	CS-18NX50-TDMS
39	CS-18NX3C-TDS	81	CCS-18NX40-TDS	123	CCS-18NX5C-TDS	165	CS-18NX50-TDS
40	CS-18NX3C-TM	82	CCS-18NX40-TM	124	CCS-18NX5C-TM	166	CS-18NX50-TM
41	CS-18NX3C-TMS	83	CCS-18NX40-TMS	125	CCS-18NX5C-TMS	167	CS-18NX50-TMS
42	CS-18NX3C-TS	84	CCS-18NX40-TS	126	CCS-18NX5C-TS	168	CS-18NX50-TS

* X = 1 (28Vdc), 2 (15Vdc), 3 (12Vdc) and 4 (24Vdc)

Series CCS-18/CS-18
High Power Multi-Throw DC–12 GHz
Normally Open Coaxial Switch



NORMALLY OPEN CCS-18N/CS-18N • CCS-18T/CS-18T PART NUMBER LIST

	PART No.		PART No.		PART No.		PART No.
169	CCS-18NX6C	211	CS-18NX60	253	CS-18NX7C	295	CCS-18NX80
170	CCS-18NX6C-D	212	CS-18NX60-D	254	CS-18NX7C-D	296	CCS-18NX80-D
171	CCS-18NX6C-DM	213	CS-18NX60-DM	255	CS-18NX7C-DM	297	CCS-18NX80-DM
172	CCS-18NX6C-M	214	CS-18NX60-M	256	CS-18NX7C-M	298	CCS-18NX80-M
173	CCS-18NX6C-MS	215	CS-18NX60-MS	257	CS-18NX7C-MS	299	CCS-18NX80-MS
174	CCS-18NX6C-S	216	CS-18NX60-S	258	CS-18NX7C-S	300	CCS-18NX80-S
175	CCS-18NX6C-T	217	CS-18NX60-T	259	CS-18NX7C-T	301	CCS-18NX80-T
176	CCS-18NX6C-TD	218	CS-18NX60-TD	260	CS-18NX7C-TD	302	CCS-18NX80-TD
177	CCS-18NX6C-TDM	219	CS-18NX60-TDM	261	CS-18NX7C-TDM	303	CCS-18NX80-TDM
178	CCS-18NX6C-TDMS	220	CS-18NX60-TDMS	262	CS-18NX7C-TDMS	304	CCS-18NX80-TDMS
179	CCS-18NX6C-TDS	221	CS-18NX60-TDS	263	CS-18NX7C-TDS	305	CCS-18NX80-TDS
180	CCS-18NX6C-TM	222	CS-18NX60-TM	264	CS-18NX7C-TM	306	CCS-18NX80-TM
181	CCS-18NX6C-TMS	223	CS-18NX60-TMS	265	CS-18NX7C-TMS	307	CCS-18NX80-TMS
182	CCS-18NX6C-TS	224	CS-18NX60-TS	266	CS-18NX7C-TS	308	CCS-18NX80-TS
183	CCS-18NX60	225	CCS-18NX7C	267	CS-18NX70	309	CS-18NX8C
184	CCS-18NX60-D	226	CCS-18NX7C-D	268	CS-18NX70-D	310	CS-18NX8C-D
185	CCS-18NX60-DM	227	CCS-18NX7C-DM	269	CS-18NX70-DM	311	CS-18NX8C-DM
186	CCS-18NX60-M	228	CCS-18NX7C-M	270	CS-18NX70-M	312	CS-18NX8C-M
187	CCS-18NX60-MS	229	CCS-18NX7C-MS	271	CS-18NX70-MS	313	CS-18NX8C-MS
188	CCS-18NX60-S	230	CCS-18NX7C-S	272	CS-18NX70-S	314	CS-18NX8C-S
189	CCS-18NX60-T	231	CCS-18NX7C-T	273	CS-18NX70-T	315	CS-18NX8C-T
190	CCS-18NX60-TD	232	CCS-18NX7C-TD	274	CS-18NX70-TD	316	CS-18NX8C-TD
191	CCS-18NX60-TDM	233	CCS-18NX7C-TDM	275	CS-18NX70-TDM	317	CS-18NX8C-TDM
192	CCS-18NX60-TDMS	234	CCS-18NX7C-TDMS	276	CS-18NX70-TDMS	318	CS-18NX8C-TDMS
193	CCS-18NX60-TDS	235	CCS-18NX7C-TDS	277	CS-18NX70-TDS	319	CS-18NX8C-TDS
194	CCS-18NX60-TM	236	CCS-18NX7C-TM	278	CS-18NX70-TM	320	CS-18NX8C-TM
195	CCS-18NX60-TMS	237	CCS-18NX7C-TMS	279	CS-18NX70-TMS	321	CS-18NX8C-TMS
196	CCS-18NX60-TS	238	CCS-18NX7C-TS	280	CS-18NX70-TS	322	CS-18NX8C-TS
197	CS-18NX6C	239	CCS-18NX70	281	CCS-18NX8C	323	CS-18NX80
198	CS-18NX6C-D	240	CCS-18NX70-D	282	CCS-18NX8C-D	324	CS-18NX80-D
199	CS-18NX6C-DM	241	CCS-18NX70-DM	283	CCS-18NX8C-DM	325	CS-18NX80-DM
200	CS-18NX6C-M	242	CCS-18NX70-M	284	CCS-18NX8C-M	326	CS-18NX80-M
201	CS-18NX6C-MS	243	CCS-18NX70-MS	285	CCS-18NX8C-MS	327	CS-18NX80-MS
202	CS-18NX6C-S	244	CCS-18NX70-S	286	CCS-18NX8C-S	328	CS-18NX80-S
203	CS-18NX6C-T	245	CCS-18NX70-T	287	CCS-18NX8C-T	329	CS-18NX80-T
204	CS-18NX6C-TD	246	CCS-18NX70-TD	288	CCS-18NX8C-TD	330	CS-18NX80-TD
205	CS-18NX6C-TDM	247	CCS-18NX70-TDM	289	CCS-18NX8C-TDM	331	CS-18NX80-TDM
206	CS-18NX6C-TDMS	248	CCS-18NX70-TDMS	290	CCS-18NX8C-TDMS	332	CS-18NX80-TDMS
207	CS-18NX6C-TDS	249	CCS-18NX70-TDS	291	CCS-18NX8C-TDS	333	CS-18NX80-TDS
208	CS-18NX6C-TM	250	CCS-18NX70-TM	292	CCS-18NX8C-TM	334	CS-18NX80-TM
209	CS-18NX6C-TMS	251	CCS-18NX70-TMS	293	CCS-18NX8C-TMS	335	CS-18NX80-TMS
210	CS-18NX6C-TS	252	CCS-18NX70-TS	294	CCS-18NX8C-TS	336	CS-18NX80-TS

* X = 1 (28Vdc), 2 (15Vdc), 3 (12Vdc) and 4 (24Vdc)

NORMALLY OPEN CCS-18N/CS-18N • CCS-18T/CS-18T PART NUMBER LIST

	PART No.		PART No.		PART No.		PART No.
337	CCS-18TX3C	379	CS-18TX30	421	CS-18TX4C	463	CCS-18TX50
338	CCS-18TX3C-D	380	CS-18TX30-D	422	CS-18TX4C-D	464	CCS-18TX50-D
339	CCS-18TX3C-DM	381	CS-18TX30-DM	423	CS-18TX4C-DM	465	CCS-18TX50-DM
340	CCS-18TX3C-M	382	CS-18TX30-M	424	CS-18TX4C-M	466	CCS-18TX50-M
341	CCS-18TX3C-MS	383	CS-18TX30-MS	425	CS-18TX4C-MS	467	CCS-18TX50-MS
342	CCS-18TX3C-S	384	CS-18TX30-S	426	CS-18TX4C-S	468	CCS-18TX50-S
343	CCS-18TX3C-T	385	CS-18TX30-T	427	CS-18TX4C-T	469	CCS-18TX50-T
344	CCS-18TX3C-TD	386	CS-18TX30-TD	428	CS-18TX4C-TD	470	CCS-18TX50-TD
345	CCS-18TX3C-TDM	387	CS-18TX30-TDM	429	CS-18TX4C-TDM	471	CCS-18TX50-TDM
346	CCS-18TX3C-TDMS	388	CS-18TX30-TDMS	430	CS-18TX4C-TDMS	472	CCS-18TX50-TDMS
347	CCS-18TX3C-TDS	389	CS-18TX30-TDS	431	CS-18TX4C-TDS	473	CCS-18TX50-TDS
348	CCS-18TX3C-TM	390	CS-18TX30-TM	432	CS-18TX4C-TM	474	CCS-18TX50-TM
349	CCS-18TX3C-TMS	391	CS-18TX30-TMS	433	CS-18TX4C-TMS	475	CCS-18TX50-TMS
350	CCS-18TX3C-TS	392	CS-18TX30-TS	434	CS-18TX4C-TS	476	CCS-18TX50-TS
351	CCS-18TX30	393	CCS-18TX4C	435	CS-18TX40	477	CS-18TX5C
352	CCS-18TX30-D	394	CCS-18TX4C-D	436	CS-18TX40-D	478	CS-18TX5C-D
353	CCS-18TX30-DM	395	CCS-18TX4C-DM	437	CS-18TX40-DM	479	CS-18TX5C-DM
354	CCS-18TX30-M	396	CCS-18TX4C-M	438	CS-18TX40-M	480	CS-18TX5C-M
355	CCS-18TX30-MS	397	CCS-18TX4C-MS	439	CS-18TX40-MS	481	CS-18TX5C-MS
356	CCS-18TX30-S	398	CCS-18TX4C-S	440	CS-18TX40-S	482	CS-18TX5C-S
357	CCS-18TX30-T	399	CCS-18TX4C-T	441	CS-18TX40-T	483	CS-18TX5C-T
358	CCS-18TX30-TD	400	CCS-18TX4C-TD	442	CS-18TX40-TD	484	CS-18TX5C-TD
359	CCS-18TX30-TDM	401	CCS-18TX4C-TDM	443	CS-18TX40-TDM	485	CS-18TX5C-TDM
360	CCS-18TX30-TDMS	402	CCS-18TX4C-TDMS	444	CS-18TX40-TDMS	486	CS-18TX5C-TDMS
361	CCS-18TX30-TDS	403	CCS-18TX4C-TDS	445	CS-18TX40-TDS	487	CS-18TX5C-TDS
362	CCS-18TX30-TM	404	CCS-18TX4C-TM	446	CS-18TX40-TM	488	CS-18TX5C-TM
363	CCS-18TX30-TMS	405	CCS-18TX4C-TMS	447	CS-18TX40-TMS	489	CS-18TX5C-TMS
364	CCS-18TX30-TS	406	CCS-18TX4C-TS	448	CS-18TX40-TS	490	CS-18TX5C-TS
365	CS-18TX3C	407	CCS-18TX40	449	CCS-18TX5C	491	CS-18TX50
366	CS-18TX3C-D	408	CCS-18TX40-D	450	CCS-18TX5C-D	492	CS-18TX50-D
367	CS-18TX3C-DM	409	CCS-18TX40-DM	451	CCS-18TX5C-DM	493	CS-18TX50-DM
368	CS-18TX3C-M	410	CCS-18TX40-M	452	CCS-18TX5C-M	494	CS-18TX50-M
369	CS-18TX3C-MS	411	CCS-18TX40-MS	453	CCS-18TX5C-MS	495	CS-18TX50-MS
370	CS-18TX3C-S	412	CCS-18TX40-S	454	CCS-18TX5C-S	496	CS-18TX50-S
371	CS-18TX3C-T	413	CCS-18TX40-T	455	CCS-18TX5C-T	497	CS-18TX50-T
372	CS-18TX3C-TD	414	CCS-18TX40-TD	456	CCS-18TX5C-TD	498	CS-18TX50-TD
373	CS-18TX3C-TDM	415	CCS-18TX40-TDM	457	CCS-18TX5C-TDM	499	CS-18TX50-TDM
374	CS-18TX3C-TDMS	416	CCS-18TX40-TDMS	458	CCS-18TX5C-TDMS	500	CS-18TX50-TDMS
375	CS-18TX3C-TDS	417	CCS-18TX40-TDS	459	CCS-18TX5C-TDS	501	CS-18TX50-TDS
376	CS-18TX3C-TM	418	CCS-18TX40-TM	460	CCS-18TX5C-TM	502	CS-18TX50-TM
377	CS-18TX3C-TMS	419	CCS-18TX40-TMS	461	CCS-18TX5C-TMS	503	CS-18TX50-TMS
378	CS-18TX3C-TS	420	CCS-18TX40-TS	462	CCS-18TX5C-TS	504	CS-18TX50-TS

* X = 1 (28Vdc), 2 (15Vdc), 3 (12Vdc) and 4 (24Vdc)

Series CCS-18/CS-18
High Power Multi-Throw DC–12 GHz
Normally Open Coaxial Switch



NORMALLY OPEN CCS-18N/CS-18N • CCS-18T/CS-18T PART NUMBER LIST

	PART No.		PART No.		PART No.		PART No.
505	CCS-18TX6C	547	CS-18TX60	589	CS-18TX7C	631	CCS-18TX80
506	CCS-18TX6C-D	548	CS-18TX60-D	590	CS-18TX7C-D	632	CCS-18TX80-D
507	CCS-18TX6C-DM	549	CS-18TX60-DM	591	CS-18TX7C-DM	633	CCS-18TX80-DM
508	CCS-18TX6C-M	550	CS-18TX60-M	592	CS-18TX7C-M	634	CCS-18TX80-M
509	CCS-18TX6C-MS	551	CS-18TX60-MS	593	CS-18TX7C-MS	635	CCS-18TX80-MS
510	CCS-18TX6C-S	552	CS-18TX60-S	594	CS-18TX7C-S	636	CCS-18TX80-S
511	CCS-18TX6C-T	553	CS-18TX60-T	595	CS-18TX7C-T	637	CCS-18TX80-T
512	CCS-18TX6C-TD	554	CS-18TX60-TD	596	CS-18TX7C-TD	638	CCS-18TX80-TD
513	CCS-18TX6C-TDM	555	CS-18TX60-TDM	597	CS-18TX7C-TDM	639	CCS-18TX80-TDM
514	CCS-18TX6C-TDMS	556	CS-18TX60-TDMS	598	CS-18TX7C-TDMS	640	CCS-18TX80-TDMS
515	CCS-18TX6C-TDS	557	CS-18TX60-TDS	599	CS-18TX7C-TDS	641	CCS-18TX80-TDS
516	CCS-18TX6C-TM	558	CS-18TX60-TM	600	CS-18TX7C-TM	642	CCS-18TX80-TM
517	CCS-18TX6C-TMS	559	CS-18TX60-TMS	601	CS-18TX7C-TMS	643	CCS-18TX80-TMS
518	CCS-18TX6C-TS	560	CS-18TX60-TS	602	CS-18TX7C-TS	644	CCS-18TX80-TS
519	CCS-18TX60	561	CCS-18TX7C	603	CS-18TX70	645	CS-18TX8C
520	CCS-18TX60-D	562	CCS-18TX7C-D	604	CS-18TX70-D	646	CS-18TX8C-D
521	CCS-18TX60-DM	563	CCS-18TX7C-DM	605	CS-18TX70-DM	647	CS-18TX8C-DM
522	CCS-18TX60-M	564	CCS-18TX7C-M	606	CS-18TX70-M	648	CS-18TX8C-M
523	CCS-18TX60-MS	565	CCS-18TX7C-MS	607	CS-18TX70-MS	649	CS-18TX8C-MS
524	CCS-18TX60-S	566	CCS-18TX7C-S	608	CS-18TX70-S	650	CS-18TX8C-S
525	CCS-18TX60-T	567	CCS-18TX7C-T	609	CS-18TX70-T	651	CS-18TX8C-T
526	CCS-18TX60-TD	568	CCS-18TX7C-TD	610	CS-18TX70-TD	652	CS-18TX8C-TD
527	CCS-18TX60-TDM	569	CCS-18TX7C-TDM	611	CS-18TX70-TDM	653	CS-18TX8C-TDM
528	CCS-18TX60-TDMS	570	CCS-18TX7C-TDMS	612	CS-18TX70-TDMS	654	CS-18TX8C-TDMS
529	CCS-18TX60-TDS	571	CCS-18TX7C-TDS	613	CS-18TX70-TDS	655	CS-18TX8C-TDS
530	CCS-18TX60-TM	572	CCS-18TX7C-TM	614	CS-18TX70-TM	656	CS-18TX8C-TM
531	CCS-18TX60-TMS	573	CCS-18TX7C-TMS	615	CS-18TX70-TMS	657	CS-18TX8C-TMS
532	CCS-18TX60-TS	574	CCS-18TX7C-TS	616	CS-18TX70-TS	658	CS-18TX8C-TS
533	CS-18TX6C	575	CCS-18TX70	617	CCS-18TX8C	659	CS-18TX80
534	CS-18TX6C-D	576	CCS-18TX70-D	618	CCS-18TX8C-D	660	CS-18TX80-D
535	CS-18TX6C-DM	577	CCS-18TX70-DM	619	CCS-18TX8C-DM	661	CS-18TX80-DM
536	CS-18TX6C-M	578	CCS-18TX70-M	620	CCS-18TX8C-M	662	CS-18TX80-M
537	CS-18TX6C-MS	579	CCS-18TX70-MS	621	CCS-18TX8C-MS	663	CS-18TX80-MS
538	CS-18TX6C-S	580	CCS-18TX70-S	622	CCS-18TX8C-S	664	CS-18TX80-S
539	CS-18TX6C-T	581	CCS-18TX70-T	623	CCS-18TX8C-T	665	CS-18TX80-T
540	CS-18TX6C-TD	582	CCS-18TX70-TD	624	CCS-18TX8C-TD	666	CS-18TX80-TD
541	CS-18TX6C-TDM	583	CCS-18TX70-TDM	625	CCS-18TX8C-TDM	667	CS-18TX80-TDM
542	CS-18TX6C-TDMS	584	CCS-18TX70-TDMS	626	CCS-18TX8C-TDMS	668	CS-18TX80-TDMS
543	CS-18TX6C-TDS	585	CCS-18TX70-TDS	627	CCS-18TX8C-TDS	669	CS-18TX80-TDS
544	CS-18TX6C-TM	586	CCS-18TX70-TM	628	CCS-18TX8C-TM	670	CS-18TX80-TM
545	CS-18TX6C-TMS	587	CCS-18TX70-TMS	629	CCS-18TX8C-TMS	671	CS-18TX80-TMS
546	CS-18TX6C-TS	588	CCS-18TX70-TS	630	CCS-18TX8C-TS	672	CS-18TX80-TS

* X = 1 (28Vdc), 2 (15Vdc), 3 (12Vdc) and 4 (24Vdc)

NORMALLY OPEN CCS-18N/CS-18N • CCS-18T/CS-18T PART NUMBER LIST

	PART No.		PART No.		PART No.		PART No.
673	CCS-18HNX3C	715	CS-18HNX30	757	CS-18HNX4C	799	CCS-18HNX50
674	CCS-18HNX3C-D	716	CS-18HNX30-D	758	CS-18HNX4C-D	800	CCS-18HNX50-D
675	CCS-18HNX3C-DM	717	CS-18HNX30-DM	759	CS-18HNX4C-DM	801	CCS-18HNX50-DM
676	CCS-18HNX3C-M	718	CS-18HNX30-M	760	CS-18HNX4C-M	802	CCS-18HNX50-M
677	CCS-18HNX3C-MS	719	CS-18HNX30-MS	761	CS-18HNX4C-MS	803	CCS-18HNX50-MS
678	CCS-18HNX3C-S	720	CS-18HNX30-S	762	CS-18HNX4C-S	804	CCS-18HNX50-S
679	CCS-18HNX3C-T	721	CS-18HNX30-T	763	CS-18HNX4C-T	805	CCS-18HNX50-T
680	CCS-18HNX3C-TD	722	CS-18HNX30-TD	764	CS-18HNX4C-TD	806	CCS-18HNX50-TD
681	CCS-18HNX3C-TDM	723	CS-18HNX30-TDM	765	CS-18HNX4C-TDM	807	CCS-18HNX50-TDM
682	CCS-18HNX3C-TDMS	724	CS-18HNX30-TDMS	766	CS-18HNX4C-TDMS	808	CCS-18HNX50-TDMS
683	CCS-18HNX3C-TDS	725	CS-18HNX30-TDS	767	CS-18HNX4C-TDS	809	CCS-18HNX50-TDS
684	CCS-18HNX3C-TM	726	CS-18HNX30-TM	768	CS-18HNX4C-TM	810	CCS-18HNX50-TM
685	CCS-18HNX3C-TMS	727	CS-18HNX30-TMS	769	CS-18HNX4C-TMS	811	CCS-18HNX50-TMS
686	CCS-18HNX3C-TS	728	CS-18HNX30-TS	770	CS-18HNX4C-TS	812	CCS-18HNX50-TS
687	CCS-18HNX30	729	CCS-18HNX4C	771	CS-18HNX40	813	CS-18HNX50C
688	CCS-18HNX30-D	730	CCS-18HNX4C-D	772	CS-18HNX40-D	814	CS-18HNX50C-D
689	CCS-18HNX30-DM	731	CCS-18HNX4C-DM	773	CS-18HNX40-DM	815	CS-18HNX50C-DM
690	CCS-18HNX30-M	732	CCS-18HNX4C-M	774	CS-18HNX40-M	816	CS-18HNX50C-M
691	CCS-18HNX30-MS	733	CCS-18HNX4C-MS	775	CS-18HNX40-MS	817	CS-18HNX50C-MS
692	CCS-18HNX30-S	734	CCS-18HNX4C-S	776	CS-18HNX40-S	818	CS-18HNX50C-S
693	CCS-18HNX30-T	735	CCS-18HNX4C-T	777	CS-18HNX40-T	819	CS-18HNX50C-T
694	CCS-18HNX30-TD	736	CCS-18HNX4C-TD	778	CS-18HNX40-TD	820	CS-18HNX50C-TD
695	CCS-18HNX30-TDM	737	CCS-18HNX4C-TDM	779	CS-18HNX40-TDM	821	CS-18HNX50C-TDM
696	CCS-18HNX30-TDMS	738	CCS-18HNX4C-TDMS	780	CS-18HNX40-TDMS	822	CS-18HNX50C-TDMS
697	CCS-18HNX30-TDS	739	CCS-18HNX4C-TDS	781	CS-18HNX40-TDS	823	CS-18HNX50C-TDS
698	CCS-18HNX30-TM	740	CCS-18HNX4C-TM	782	CS-18HNX40-TM	824	CS-18HNX50C-TM
699	CCS-18HNX30-TMS	741	CCS-18HNX4C-TMS	783	CS-18HNX40-TMS	825	CS-18HNX50C-TMS
700	CCS-18HNX30-TS	742	CCS-18HNX4C-TS	784	CS-18HNX40-TS	826	CS-18HNX50C-TS
701	CS-18HNX3C	743	CCS-18HNX40	785	CCS-18HNX50C	827	CS-18HNX50
702	CS-18HNX3C-D	744	CCS-18HNX40-D	786	CCS-18HNX50C-D	828	CS-18HNX50-D
703	CS-18HNX3C-DM	745	CCS-18HNX40-DM	787	CCS-18HNX50C-DM	829	CS-18HNX50-DM
704	CS-18HNX3C-M	746	CCS-18HNX40-M	788	CCS-18HNX50C-M	830	CS-18HNX50-M
705	CS-18HNX3C-MS	747	CCS-18HNX40-MS	789	CCS-18HNX50C-MS	831	CS-18HNX50-MS
706	CS-18HNX3C-S	748	CCS-18HNX40-S	790	CCS-18HNX50C-S	832	CS-18HNX50-S
707	CS-18HNX3C-T	749	CCS-18HNX40-T	791	CCS-18HNX50C-T	833	CS-18HNX50-T
708	CS-18HNX3C-TD	750	CCS-18HNX40-TD	792	CCS-18HNX50C-TD	834	CS-18HNX50-TD
709	CS-18HNX3C-TDM	751	CCS-18HNX40-TDM	793	CCS-18HNX50C-TDM	835	CS-18HNX50-TDM
710	CS-18HNX3C-TDMS	752	CCS-18HNX40-TDMS	794	CCS-18HNX50C-TDMS	836	CS-18HNX50-TDMS
711	CS-18HNX3C-TDS	753	CCS-18HNX40-TDS	795	CCS-18HNX50C-TDS	837	CS-18HNX50-TDS
712	CS-18HNX3C-TM	754	CCS-18HNX40-TM	796	CCS-18HNX50C-TM	838	CS-18HNX50-TM
713	CS-18HNX3C-TMS	755	CCS-18HNX40-TMS	797	CCS-18HNX50C-TMS	839	CS-18HNX50-TMS
714	CS-18HNX3C-TS	756	CCS-18HNX40-TS	798	CCS-18HNX50C-TS	840	CS-18HNX50-TS

Series CCS-18/CS-18
High Power Multi-Throw DC–12 GHz
Normally Open Coaxial Switch



NORMALLY OPEN CCS-18N/CS-18N • CCS-18T/CS-18T PART NUMBER LIST

	PART No.		PART No.		PART No.		PART No.
841	CCS-18HNX6C	883	CS-18HNX60	925	CS-18HNX7C	967	CCS-18HNX80
842	CCS-18HNX6C-D	884	CS-18HNX60-D	926	CS-18HNX7C-D	968	CCS-18HNX80-D
843	CCS-18HNX6C-DM	885	CS-18HNX60-DM	927	CS-18HNX7C-DM	969	CCS-18HNX80-DM
844	CCS-18HNX6C-M	886	CS-18HNX60-M	928	CS-18HNX7C-M	970	CCS-18HNX80-M
845	CCS-18HNX6C-MS	887	CS-18HNX60-MS	929	CS-18HNX7C-MS	971	CCS-18HNX80-MS
846	CCS-18HNX6C-S	888	CS-18HNX60-S	930	CS-18HNX7C-S	972	CCS-18HNX80-S
847	CCS-18HNX6C-T	889	CS-18HNX60-T	931	CS-18HNX7C-T	973	CCS-18HNX80-T
848	CCS-18HNX6C-TD	890	CS-18HNX60-TD	932	CS-18HNX7C-TD	974	CCS-18HNX80-TD
849	CCS-18HNX6C-TDM	891	CS-18HNX60-TDM	933	CS-18HNX7C-TDM	975	CCS-18HNX80-TDM
850	CCS-18HNX6C-TDMS	892	CS-18HNX60-TDMS	934	CS-18HNX7C-TDMS	976	CCS-18HNX80-TDMS
851	CCS-18HNX6C-TDS	893	CS-18HNX60-TDS	935	CS-18HNX7C-TDS	977	CCS-18HNX80-TDS
852	CCS-18HNX6C-TM	894	CS-18HNX60-TM	936	CS-18HNX7C-TM	978	CCS-18HNX80-TM
853	CCS-18HNX6C-TMS	895	CS-18HNX60-TMS	937	CS-18HNX7C-TMS	979	CCS-18HNX80-TMS
854	CCS-18HNX6C-TS	896	CS-18HNX60-TS	938	CS-18HNX7C-TS	980	CCS-18HNX80-TS
855	CCS-18HNX60	897	CCS-18HNX7C	939	CS-18HNX70	981	CS-18HNX8C
856	CCS-18HNX60-D	898	CCS-18HNX7C-D	940	CS-18HNX70-D	982	CS-18HNX8C-D
857	CCS-18HNX60-DM	899	CCS-18HNX7C-DM	941	CS-18HNX70-DM	983	CS-18HNX8C-DM
858	CCS-18HNX60-M	900	CCS-18HNX7C-M	942	CS-18HNX70-M	984	CS-18HNX8C-M
859	CCS-18HNX60-MS	901	CCS-18HNX7C-MS	943	CS-18HNX70-MS	985	CS-18HNX8C-MS
860	CCS-18HNX60-S	902	CCS-18HNX7C-S	944	CS-18HNX70-S	986	CS-18HNX8C-S
861	CCS-18HNX60-T	903	CCS-18HNX7C-T	945	CS-18HNX70-T	987	CS-18HNX8C-T
862	CCS-18HNX60-TD	904	CCS-18HNX7C-TD	946	CS-18HNX70-TD	988	CS-18HNX8C-TD
863	CCS-18HNX60-TDM	905	CCS-18HNX7C-TDM	947	CS-18HNX70-TDM	989	CS-18HNX8C-TDM
864	CCS-18HNX60-TDMS	906	CCS-18HNX7C-TDMS	948	CS-18HNX70-TDMS	990	CS-18HNX8C-TDMS
865	CCS-18HNX60-TDS	907	CCS-18HNX7C-TDS	949	CS-18HNX70-TDS	991	CS-18HNX8C-TDS
866	CCS-18HNX60-TM	908	CCS-18HNX7C-TM	950	CS-18HNX70-TM	992	CS-18HNX8C-TM
867	CCS-18HNX60-TMS	909	CCS-18HNX7C-TMS	951	CS-18HNX70-TMS	993	CS-18HNX8C-TMS
868	CCS-18HNX60-TS	910	CCS-18HNX7C-TS	952	CS-18HNX70-TS	994	CS-18HNX8C-TS
869	CS-18HNX6C	911	CCS-18HNX70	953	CCS-18HNX8C	995	CS-18HNX80
870	CS-18HNX6C-D	912	CCS-18HNX70-D	954	CCS-18HNX8C-D	996	CS-18HNX80-D
871	CS-18HNX6C-DM	913	CCS-18HNX70-DM	955	CCS-18HNX8C-DM	997	CS-18HNX80-DM
872	CS-18HNX6C-M	914	CCS-18HNX70-M	956	CCS-18HNX8C-M	998	CS-18HNX80-M
873	CS-18HNX6C-MS	915	CCS-18HNX70-MS	957	CCS-18HNX8C-MS	999	CS-18HNX80-MS
874	CS-18HNX6C-S	916	CCS-18HNX70-S	958	CCS-18HNX8C-S	1000	CS-18HNX80-S
875	CS-18HNX6C-T	917	CCS-18HNX70-T	959	CCS-18HNX8C-T	1001	CS-18HNX80-T
876	CS-18HNX6C-TD	918	CCS-18HNX70-TD	960	CCS-18HNX8C-TD	1002	CS-18HNX80-TD
877	CS-18HNX6C-TDM	919	CCS-18HNX70-TDM	961	CCS-18HNX8C-TDM	1003	CS-18HNX80-TDM
878	CS-18HNX6C-TDMS	920	CCS-18HNX70-TDMS	962	CCS-18HNX8C-TDMS	1004	CS-18HNX80-TDMS
879	CS-18HNX6C-TDS	921	CCS-18HNX70-TDS	963	CCS-18HNX8C-TDS	1005	CS-18HNX80-TDS
880	CS-18HNX6C-TM	922	CCS-18HNX70-TM	964	CCS-18HNX8C-TM	1006	CS-18HNX80-TM
881	CS-18HNX6C-TMS	923	CCS-18HNX70-TMS	965	CCS-18HNX8C-TMS	1007	CS-18HNX80-TMS
882	CS-18HNX6C-TS	924	CCS-18HNX70-TS	966	CCS-18HNX8C-TS	1008	CS-18HNX80-TS

NORMALLY OPEN CCS-18N/CS-18N • CCS-18T/CS-18T PART NUMBER LIST

	PART No.		PART No.		PART No.		PART No.
1009	CCS-18HTX3C	1051	CS-18HTX30	1093	CS-18HTX4C	1135	CCS-18HTX50
1010	CCS-18HTX3C-D	1052	CS-18HTX30-D	1094	CS-18HTX4C-D	1136	CCS-18HTX50-D
1011	CCS-18HTX3C-DM	1053	CS-18HTX30-DM	1095	CS-18HTX4C-DM	1137	CCS-18HTX50-DM
1012	CCS-18HTX3C-M	1054	CS-18HTX30-M	1096	CS-18HTX4C-M	1138	CCS-18HTX50-M
1013	CCS-18HTX3C-MS	1055	CS-18HTX30-MS	1097	CS-18HTX4C-MS	1139	CCS-18HTX50-MS
1014	CCS-18HTX3C-S	1056	CS-18HTX30-S	1098	CS-18HTX4C-S	1140	CCS-18HTX50-S
1015	CCS-18HTX3C-T	1057	CS-18HTX30-T	1099	CS-18HTX4C-T	1141	CCS-18HTX50-T
1016	CCS-18HTX3C-TD	1058	CS-18HTX30-TD	1100	CS-18HTX4C-TD	1142	CCS-18HTX50-TD
1017	CCS-18HTX3C-TDM	1059	CS-18HTX30-TDM	1101	CS-18HTX4C-TDM	1143	CCS-18HTX50-TDM
1018	CCS-18HTX3C-TDMS	1060	CS-18HTX30-TDMS	1102	CS-18HTX4C-TDMS	1144	CCS-18HTX50-TDMS
1019	CCS-18HTX3C-TDS	1061	CS-18HTX30-TDS	1103	CS-18HTX4C-TDS	1145	CCS-18HTX50-TDS
1020	CCS-18HTX3C-TM	1062	CS-18HTX30-TM	1104	CS-18HTX4C-TM	1146	CCS-18HTX50-TM
1021	CCS-18HTX3C-TMS	1063	CS-18HTX30-TMS	1105	CS-18HTX4C-TMS	1147	CCS-18HTX50-TMS
1022	CCS-18HTX3C-TS	1064	CS-18HTX30-TS	1106	CS-18HTX4C-TS	1148	CCS-18HTX50-TS
1023	CCS-18HTX30	1065	CCS-18HTX4C	1107	CS-18HTX40	1149	CS-18HTX5C
1024	CCS-18HTX30-D	1066	CCS-18HTX4C-D	1108	CS-18HTX40-D	1150	CS-18HTX5C-D
1025	CCS-18HTX30-DM	1067	CCS-18HTX4C-DM	1109	CS-18HTX40-DM	1151	CS-18HTX5C-DM
1026	CCS-18HTX30-M	1068	CCS-18HTX4C-M	1110	CS-18HTX40-M	1152	CS-18HTX5C-M
1027	CCS-18HTX30-MS	1069	CCS-18HTX4C-MS	1111	CS-18HTX40-MS	1153	CS-18HTX5C-MS
1028	CCS-18HTX30-S	1070	CCS-18HTX4C-S	1112	CS-18HTX40-S	1154	CS-18HTX5C-S
1029	CCS-18HTX30-T	1071	CCS-18HTX4C-T	1113	CS-18HTX40-T	1155	CS-18HTX5C-T
1030	CCS-18HTX30-TD	1072	CCS-18HTX4C-TD	1114	CS-18HTX40-TD	1156	CS-18HTX5C-TD
1031	CCS-18HTX30-TDM	1073	CCS-18HTX4C-TDM	1115	CS-18HTX40-TDM	1157	CS-18HTX5C-TDM
1032	CCS-18HTX30-TDMS	1074	CCS-18HTX4C-TDMS	1116	CS-18HTX40-TDMS	1158	CS-18HTX5C-TDMS
1033	CCS-18HTX30-TDS	1075	CCS-18HTX4C-TDS	1117	CS-18HTX40-TDS	1159	CS-18HTX5C-TDS
1034	CCS-18HTX30-TM	1076	CCS-18HTX4C-TM	1118	CS-18HTX40-TM	1160	CS-18HTX5C-TM
1035	CCS-18HTX30-TMS	1077	CCS-18HTX4C-TMS	1119	CS-18HTX40-TMS	1161	CS-18HTX5C-TMS
1036	CCS-18HTX30-TS	1078	CCS-18HTX4C-TS	1120	CS-18HTX40-TS	1162	CS-18HTX5C-TS
1037	CS-18HTX3C	1079	CCS-18HTX40	1121	CCS-18HTX5C	1163	CS-18HTX50
1038	CS-18HTX3C-D	1080	CCS-18HTX40-D	1122	CCS-18HTX5C-D	1164	CS-18HTX50-D
1039	CS-18HTX3C-DM	1081	CCS-18HTX40-DM	1123	CCS-18HTX5C-DM	1165	CS-18HTX50-DM
1040	CS-18HTX3C-M	1082	CCS-18HTX40-M	1124	CCS-18HTX5C-M	1166	CS-18HTX50-M
1041	CS-18HTX3C-MS	1083	CCS-18HTX40-MS	1125	CCS-18HTX5C-MS	1167	CS-18HTX50-MS
1042	CS-18HTX3C-S	1084	CCS-18HTX40-S	1126	CCS-18HTX5C-S	1168	CS-18HTX50-S
1043	CS-18HTX3C-T	1085	CCS-18HTX40-T	1127	CCS-18HTX5C-T	1169	CS-18HTX50-T
1044	CS-18HTX3C-TD	1086	CCS-18HTX40-TD	1128	CCS-18HTX5C-TD	1170	CS-18HTX50-TD
1045	CS-18HTX3C-TDM	1087	CCS-18HTX40-TDM	1129	CCS-18HTX5C-TDM	1171	CS-18HTX50-TDM
1046	CS-18HTX3C-TDMS	1088	CCS-18HTX40-TDMS	1130	CCS-18HTX5C-TDMS	1172	CS-18HTX50-TDMS
1047	CS-18HTX3C-TDS	1089	CCS-18HTX40-TDS	1131	CCS-18HTX5C-TDS	1173	CS-18HTX50-TDS
1048	CS-18HTX3C-TM	1090	CCS-18HTX40-TM	1132	CCS-18HTX5C-TM	1174	CS-18HTX50-TM
1049	CS-18HTX3C-TMS	1091	CCS-18HTX40-TMS	1133	CCS-18HTX5C-TMS	1175	CS-18HTX50-TMS
1050	CS-18HTX3C-TS	1092	CCS-18HTX40-TS	1134	CCS-18HTX5C-TS	1176	CS-18HTX50-TS

Series CCS-18/CS-18
High Power Multi-Throw DC–12 GHz
Normally Open Coaxial Switch



NORMALLY OPEN CCS-18N/CS-18N • CCS-18T/CS-18T PART NUMBER LIST

	PART No.		PART No.		PART No.		PART No.
1177	CCS-18HTX6C	1219	CS-18HTX60	1261	CS-18HTX7C	1303	CCS-18HTX80
1178	CCS-18HTX6C-D	1220	CS-18HTX60-D	1262	CS-18HTX7C-D	1304	CCS-18HTX80-D
1179	CCS-18HTX6C-DM	1221	CS-18HTX60-DM	1263	CS-18HTX7C-DM	1305	CCS-18HTX80-DM
1180	CCS-18HTX6C-M	1222	CS-18HTX60-M	1264	CS-18HTX7C-M	1306	CCS-18HTX80-M
1181	CCS-18HTX6C-MS	1223	CS-18HTX60-MS	1265	CS-18HTX7C-MS	1307	CCS-18HTX80-MS
1182	CCS-18HTX6C-S	1224	CS-18HTX60-S	1266	CS-18HTX7C-S	1308	CCS-18HTX80-S
1183	CCS-18HTX6C-T	1225	CS-18HTX60-T	1267	CS-18HTX7C-T	1309	CCS-18HTX80-T
1184	CCS-18HTX6C-TD	1226	CS-18HTX60-TD	1268	CS-18HTX7C-TD	1310	CCS-18HTX80-TD
1185	CCS-18HTX6C-TDM	1227	CS-18HTX60-TDM	1269	CS-18HTX7C-TDM	1311	CCS-18HTX80-TDM
1186	CCS-18HTX6C-TDMS	1228	CS-18HTX60-TDMS	1270	CS-18HTX7C-TDMS	1312	CCS-18HTX80-TDMS
1187	CCS-18HTX6C-TDS	1229	CS-18HTX60-TDS	1271	CS-18HTX7C-TDS	1313	CCS-18HTX80-TDS
1188	CCS-18HTX6C-TM	1230	CS-18HTX60-TM	1272	CS-18HTX7C-TM	1314	CCS-18HTX80-TM
1189	CCS-18HTX6C-TMS	1231	CS-18HTX60-TMS	1273	CS-18HTX7C-TMS	1315	CCS-18HTX80-TMS
1190	CCS-18HTX6C-TS	1232	CS-18HTX60-TS	1274	CS-18HTX7C-TS	1316	CCS-18HTX80-TS
1191	CCS-18HTX60	1233	CCS-18HTX7C	1275	CS-18HTX70	1317	CS-18HTX8C
1192	CCS-18HTX60-D	1234	CCS-18HTX7C-D	1276	CS-18HTX70-D	1318	CS-18HTX8C-D
1193	CCS-18HTX60-DM	1235	CCS-18HTX7C-DM	1277	CS-18HTX70-DM	1319	CS-18HTX8C-DM
1194	CCS-18HTX60-M	1236	CCS-18HTX7C-M	1278	CS-18HTX70-M	1320	CS-18HTX8C-M
1195	CCS-18HTX60-MS	1237	CCS-18HTX7C-MS	1279	CS-18HTX70-MS	1321	CS-18HTX8C-MS
1196	CCS-18HTX60-S	1238	CCS-18HTX7C-S	1280	CS-18HTX70-S	1322	CS-18HTX8C-S
1197	CCS-18HTX60-T	1239	CCS-18HTX7C-T	1281	CS-18HTX70-T	1323	CS-18HTX8C-T
1198	CCS-18HTX60-TD	1240	CCS-18HTX7C-TD	1282	CS-18HTX70-TD	1324	CS-18HTX8C-TD
1199	CCS-18HTX60-TDM	1241	CCS-18HTX7C-TDM	1283	CS-18HTX70-TDM	1325	CS-18HTX8C-TDM
1200	CCS-18HTX60-TDMS	1242	CCS-18HTX7C-TDMS	1284	CS-18HTX70-TDMS	1326	CS-18HTX8C-TDMS
1201	CCS-18HTX60-TDS	1243	CCS-18HTX7C-TDS	1285	CS-18HTX70-TDS	1327	CS-18HTX8C-TDS
1202	CCS-18HTX60-TM	1244	CCS-18HTX7C-TM	1286	CS-18HTX70-TM	1328	CS-18HTX8C-TM
1203	CCS-18HTX60-TMS	1245	CCS-18HTX7C-TMS	1287	CS-18HTX70-TMS	1329	CS-18HTX8C-TMS
1204	CCS-18HTX60-TS	1246	CCS-18HTX7C-TS	1288	CS-18HTX70-TS	1330	CS-18HTX8C-TS
1205	CS-18HTX6C	1247	CCS-18HTX70	1289	CCS-18HTX8C	1331	CS-18HTX80
1206	CS-18HTX6C-D	1248	CCS-18HTX70-D	1290	CCS-18HTX8C-D	1332	CS-18HTX80-D
1207	CS-18HTX6C-DM	1249	CCS-18HTX70-DM	1291	CCS-18HTX8C-DM	1333	CS-18HTX80-DM
1208	CS-18HTX6C-M	1250	CCS-18HTX70-M	1292	CCS-18HTX8C-M	1334	CS-18HTX80-M
1209	CS-18HTX6C-MS	1251	CCS-18HTX70-MS	1293	CCS-18HTX8C-MS	1335	CS-18HTX80-MS
1210	CS-18HTX6C-S	1252	CCS-18HTX70-S	1294	CCS-18HTX8C-S	1336	CS-18HTX80-S
1211	CS-18HTX6C-T	1253	CCS-18HTX70-T	1295	CCS-18HTX8C-T	1337	CS-18HTX80-T
1212	CS-18HTX6C-TD	1254	CCS-18HTX70-TD	1296	CCS-18HTX8C-TD	1338	CS-18HTX80-TD
1213	CS-18HTX6C-TDM	1255	CCS-18HTX70-TDM	1297	CCS-18HTX8C-TDM	1339	CS-18HTX80-TDM
1214	CS-18HTX6C-TDMS	1256	CCS-18HTX70-TDMS	1298	CCS-18HTX8C-TDMS	1340	CS-18HTX80-TDMS
1215	CS-18HTX6C-TDS	1257	CCS-18HTX70-TDS	1299	CCS-18HTX8C-TDS	1341	CS-18HTX80-TDS
1216	CS-18HTX6C-TM	1258	CCS-18HTX70-TM	1300	CCS-18HTX8C-TM	1342	CS-18HTX80-TM
1217	CS-18HTX6C-TMS	1259	CCS-18HTX70-TMS	1301	CCS-18HTX8C-TMS	1343	CS-18HTX80-TMS
1218	CS-18HTX6C-TS	1260	CCS-18HTX70-TS	1302	CCS-18HTX8C-TS	1344	CS-18HTX80-TS

Mouser Electronics

Authorized Distributor

Click to View Pricing, Inventory, Delivery & Lifecycle Information:

[Teledyne Relays:](#)

[CCS-18N14C](#) [CCS-18N330](#)