

High voltage power Schottky rectifier

Datasheet - production data

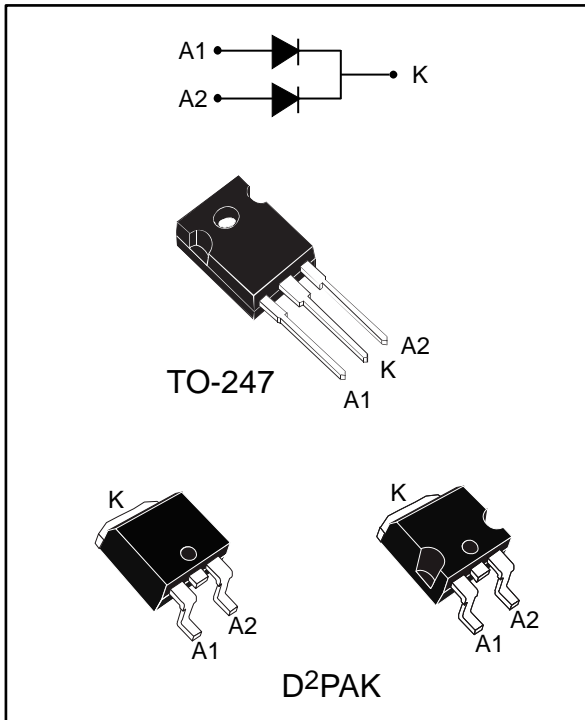

Features

- High junction temperature capability
- Good trade off between leakage current and forward voltage drop
- Low leakage current
- Avalanche capability specified
- ECOPACK®2 compliant component for D2PAK on demand

Description

Dual center tap Schottky rectifier designed for high frequency switch mode power supply.

Table 1: Device summary

Symbol	Value
$I_{F(AV)}$	2 x 15 A
V_{RRM}	170 V
T_j (max)	175 °C
V_F (typ)	0.69 V

1 Characteristics

Table 2: Absolute ratings (limiting values, per diode, at 25 °C, unless otherwise specified)

Symbol	Parameter		Value	Unit	
V _{RRM}	Repetitive peak reverse voltage		170	V	
I _{F(RMS)}	Forward rms current		30	A	
I _{F(AV)}	Average forward current δ = 0.5, square wave	T _C = 150 °C	Per diode	15	A
			Per device	30	
I _{FSM}	Surge non repetitive forward current	tp = 10 ms sinusoidal	220	A	
P _{ARM}	Repetitive peak avalanche power	tp = 10 μs, T _j = 125 °C	750	W	
T _{stg}	Storage temperature range		-65 to +175	°C	
T _j	Maximum operating junction temperature ⁽¹⁾		+175	°C	

Notes:

⁽¹⁾(dP_{tot}/dT_j) < (1/R_{th(j-a)}) condition to avoid thermal runaway for a diode on its own heatsink.

Table 3: Thermal parameter

Symbol	Parameter		Max. value	Unit	
R _{th(j-c)}	Junction to case	D ² PAK	Per diode	1.6	°C/W
		TO-247		1.5	
		D ² PAK	Total	0.95	
		TO-247		0.9	
R _{th(c)}	Coupling	D ² PAK	Coupling	0.3	°C/W
		TO-247			

When the diodes 1 and 2 are used simultaneously:

$$\Delta T_j (\text{diode1}) = P_{(\text{diode1})} \times R_{th(j-c)} (\text{per diode}) + P_{(\text{diode2})} \times R_{th(c)}$$

Table 4: Static electrical characteristics (per diode)

Symbol	Parameter	Test conditions		Min.	Typ.	Max.	Unit
$I_R^{(1)}$	Reverse leakage current	$T_j = 25\text{ °C}$	$V_R = V_{RRM}$	-		20	μA
		$T_j = 125\text{ °C}$		-	5	20	mA
$V_F^{(2)}$	Forward voltage drop	$T_j = 25\text{ °C}$	$I_F = 15\text{ A}$	-		0.92	V
		$T_j = 125\text{ °C}$		-	0.69	0.75	
		$T_j = 25\text{ °C}$	$I_F = 30\text{ A}$	-		1	
		$T_j = 125\text{ °C}$		-	0.8	0.86	

Notes:

(1) Pulse test: $t_p = 5\text{ ms}$, $\delta < 2\%$

(2) Pulse test: $t_p = 380\text{ }\mu\text{s}$, $\delta < 2\%$

To evaluate the conduction losses use the following equation:

$$P = 0.64 \times I_{F(AV)} + 0.0073 I_{F(RMS)}^2$$

1.1 Characteristics (curves)

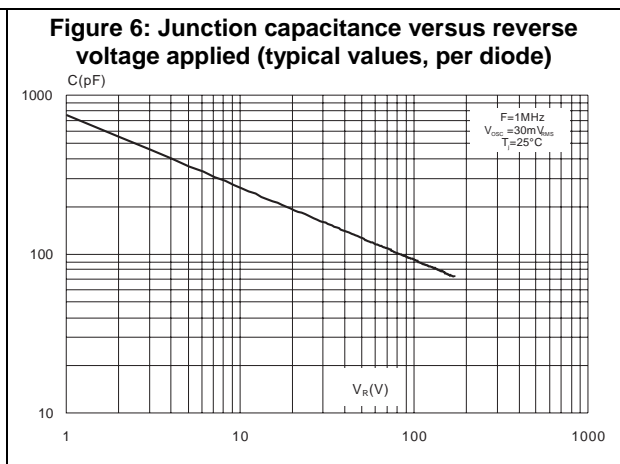
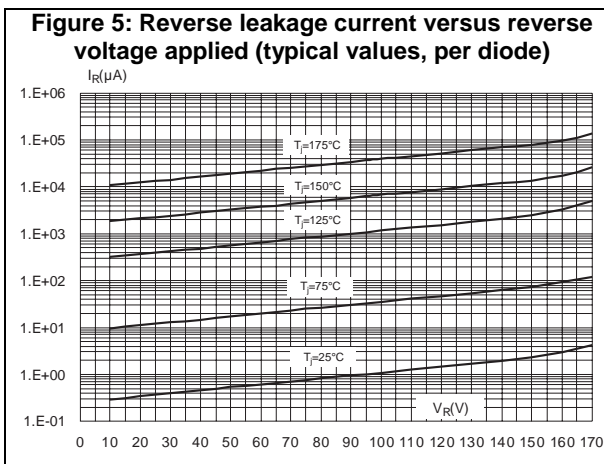
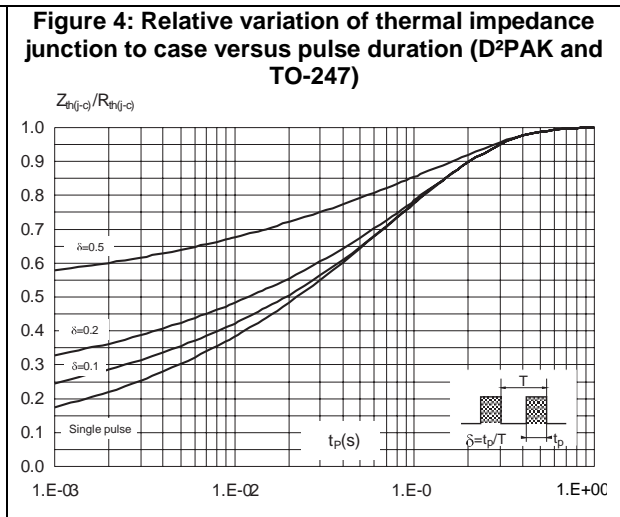
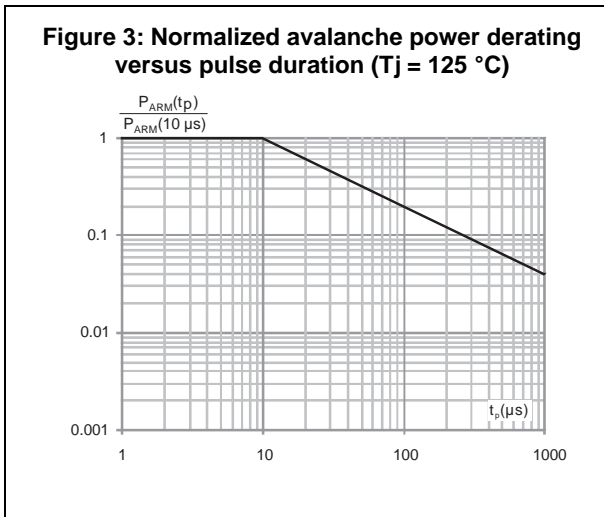
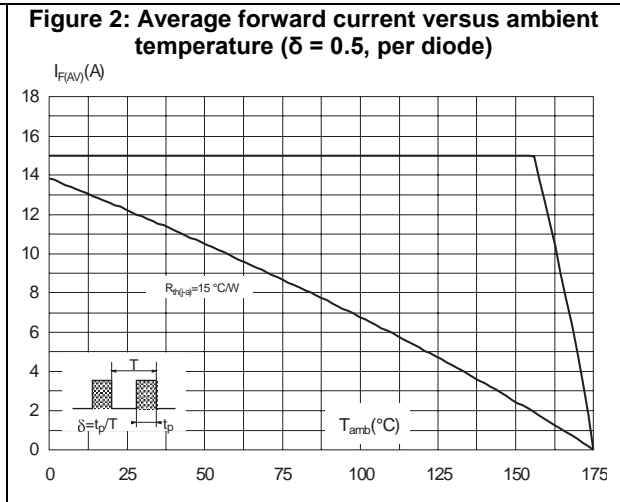
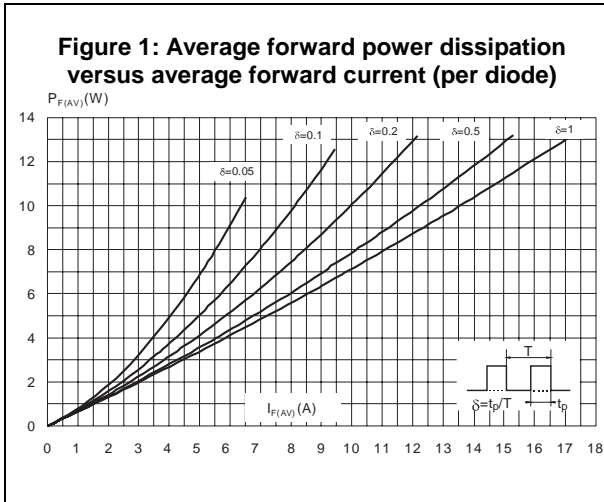

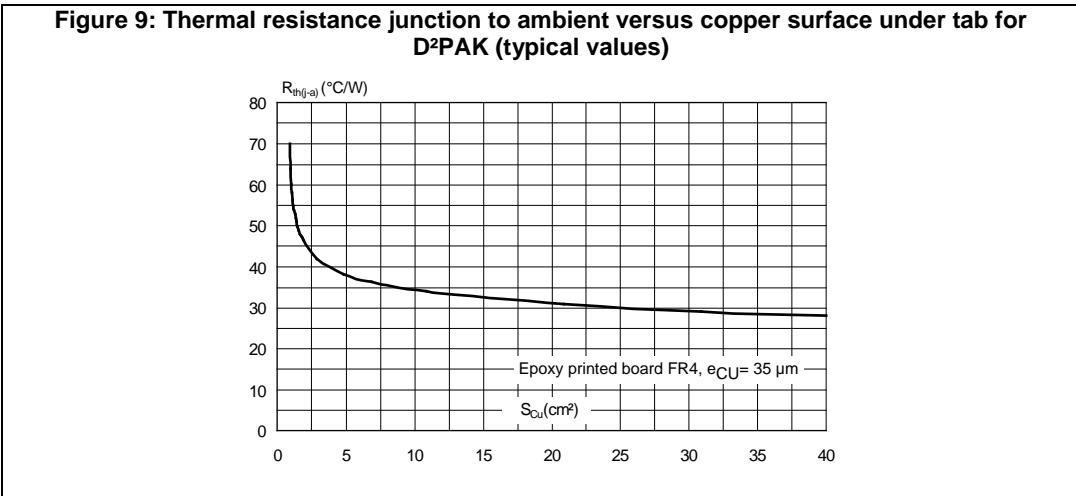
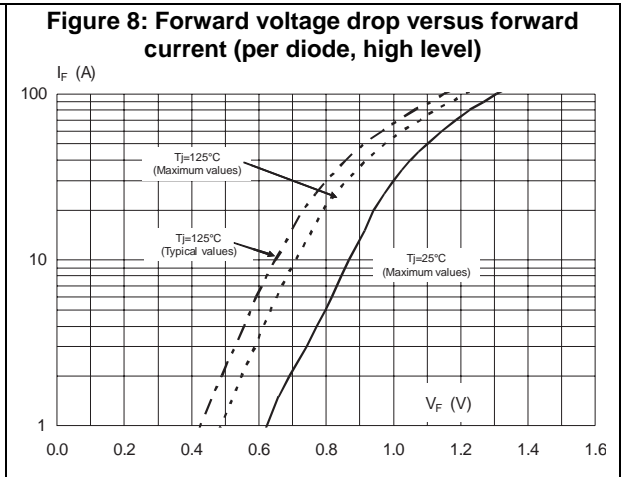
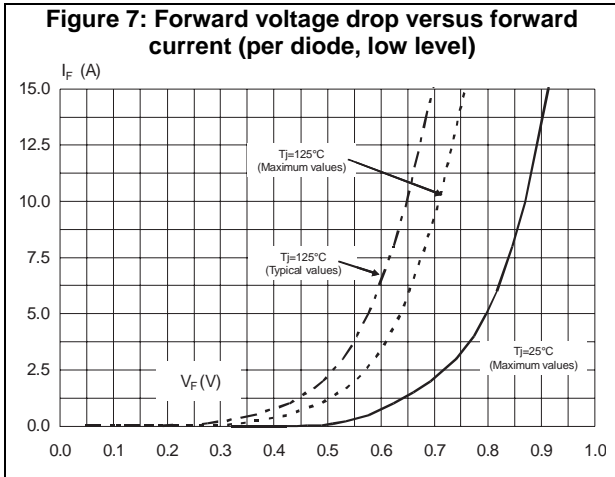

2 Package information

In order to meet environmental requirements, ST offers these devices in different grades of ECOPACK® packages, depending on their level of environmental compliance. ECOPACK® specifications, grade definitions and product status are available at: www.st.com. ECOPACK® is an ST trademark.

- Cooling method: by conduction (C)
- Epoxy meets UL 94,V0
- Recommended torque values: 0.55 N·m (for TO-247)
- Maximum torque values: 1.0 N·m maximum (for TO-247)

2.1 D²PAK package information

Figure 10: D²PAK package outline

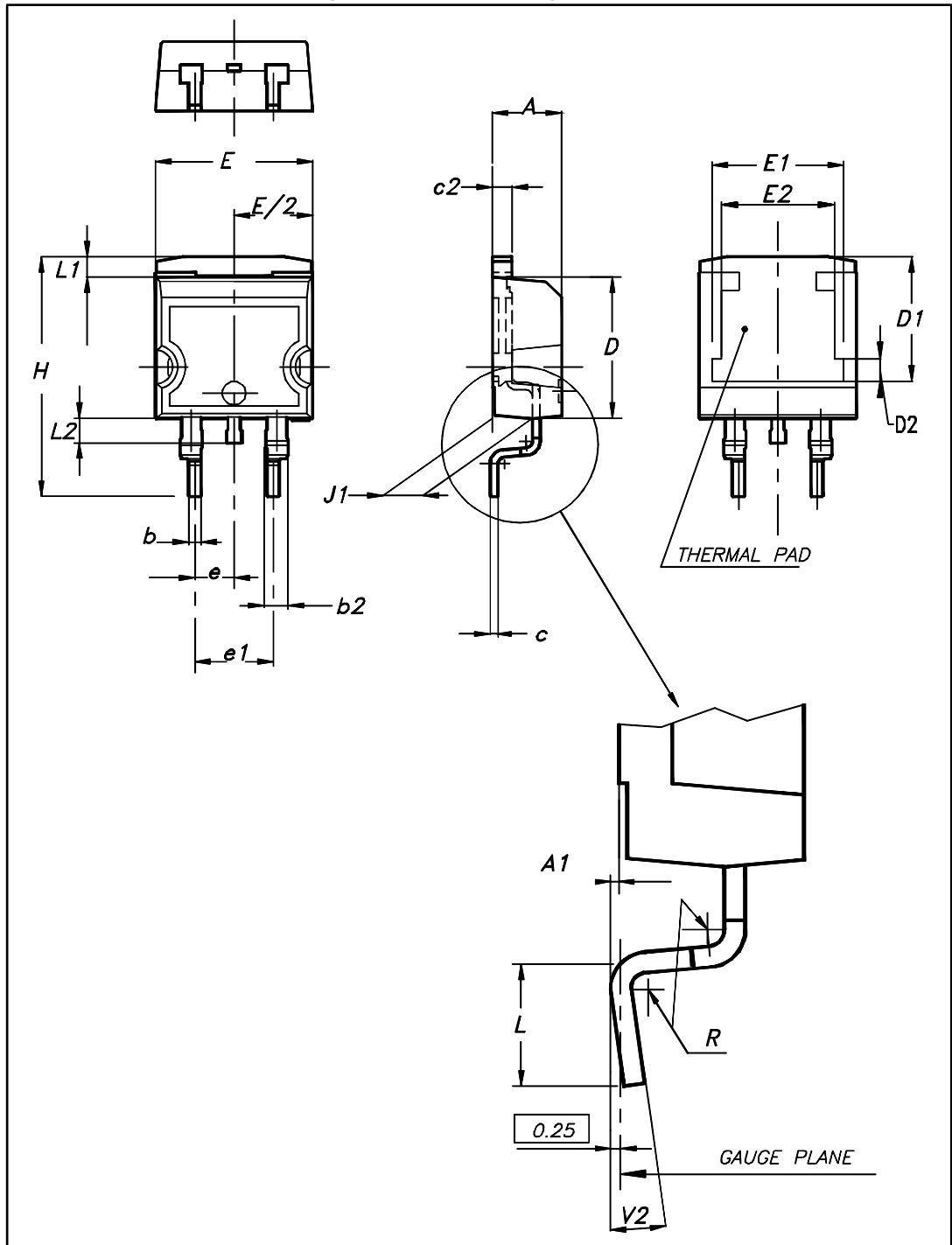

This package drawing may slightly differ from the physical package. However, all the specified dimensions are guaranteed.

Table 5: D²PAK package mechanical data

Ref.	Dimensions			
	Millimeters		Inches	
	Min.	Max.	Min.	Max.
A	4.36	4.60	0.172	0.181
A1	0.00	0.25	0.000	0.010
b	0.70	0.93	0.028	0.037
b2	1.14	1.70	0.045	0.067
c	0.38	0.69	0.015	0.027
c2	1.19	1.36	0.047	0.053
D	8.60	9.35	0.339	0.368
D1	6.90	8.00	0.272	0.311
D2	1.10	1.50	0.043	0.060
E	10.00	10.55	0.394	0.415
E1	8.10	8.90	0.319	0.346
E2	6.85	7.25	0.266	0.282
e	2.54 typ.		0.100	
e1	4.88	5.28	0.190	0.205
H	15.00	15.85	0.591	0.624
J1	2.49	2.90	0.097	0.112
L	1.90	2.79	0.075	0.110
L1	1.27	1.65	0.049	0.065
L2	1.30	1.78	0.050	0.070
R	0.4 typ.		0.015	
V2	0°	8°	0°	8°

Figure 11: D²PAK recommended footprint (dimensions in mm)

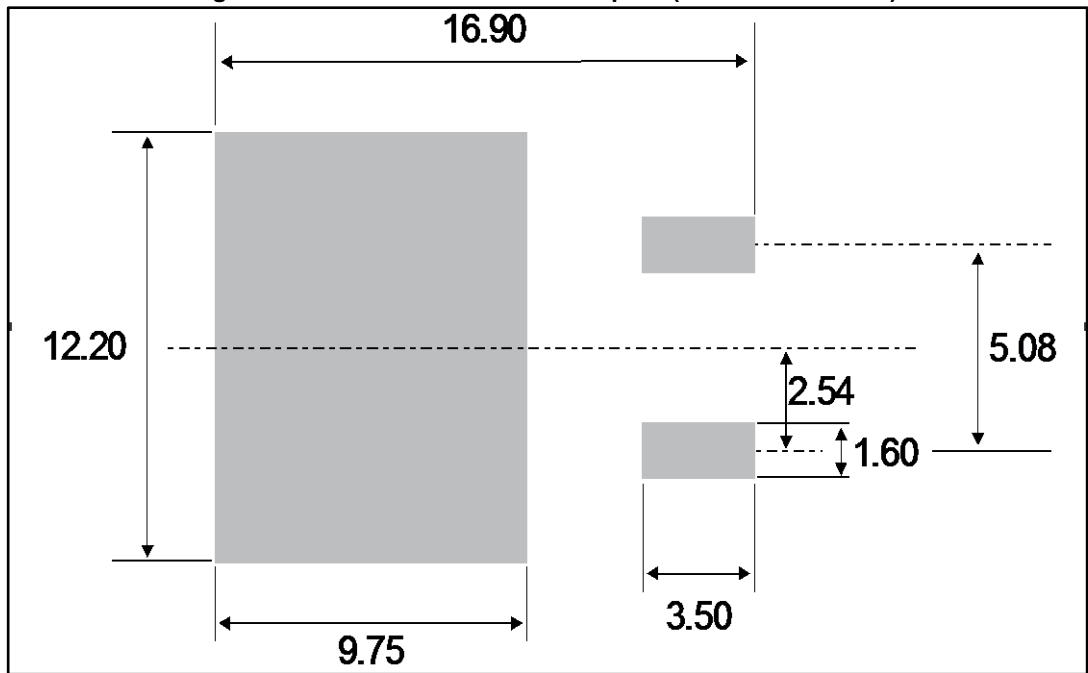

2.2 TO-247 package information

Figure 12: TO-247 package outline

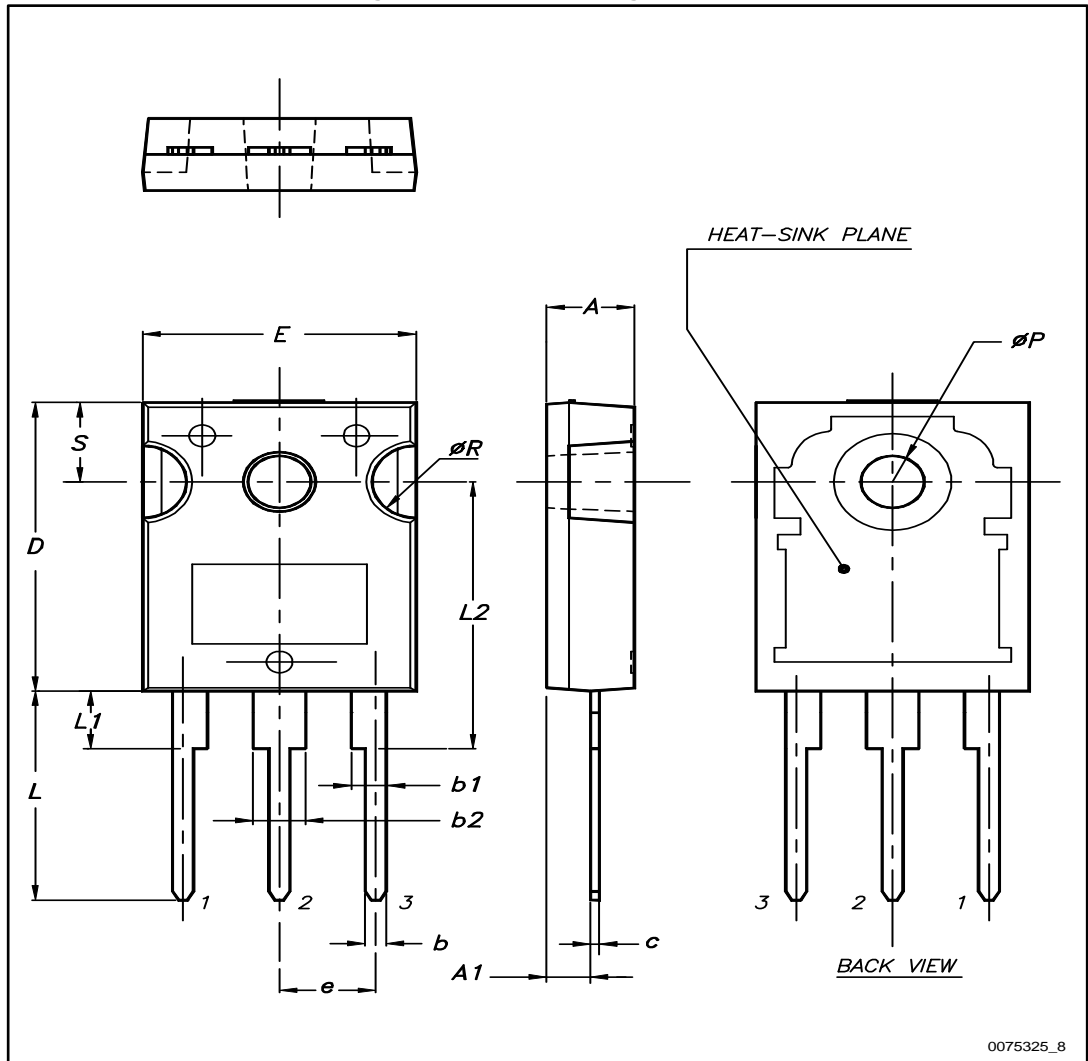

Table 6: TO-247 package mechanical data

Ref.	Dimensions					
	Millimeters			Inches		
	Min.	Typ.	Max.	Min.	Typ.	Max.
A	4.85		5.15	0.191		0.203
A1	2.20		2.60	0.086		0.102
b	1.00		1.40	0.039		0.055
b1	2.00		2.40	0.078		0.094
b2	3.00		3.40	0.118		0.133
c	0.40		0.80	0.015		0.031
D ⁽¹⁾	19.85		20.15	0.781		0.793
E	15.45		15.75	0.608		0.620
e	5.30	5.45	5.60	0.209	0.215	0.220
L	14.20		14.80	0.559		0.582
L1	3.70		4.30	0.145		0.169
L2		18.50			0.728	
ØP ⁽²⁾	3.55		3.65	0.139		0.143
ØR	4.50		5.50	0.177		0.217
S	5.30	5.50	5.70	0.209	0.216	0.224

Notes:

⁽¹⁾Dimension D plus gate protusion does not exceed 20.5 mm

⁽²⁾Resin thickness around the mounting hole is not less than 0.9 mm.

3 Ordering information

Table 7: Ordering information

Order code	Marking	Package	Weight	Base qty	Delivery mode
STPS30170CW	STPS30170CW	TO-247	4.40g	30	Tube
STPS30170CG-TR	STPS30170CG	D ² PAK	1.48g	1000	Tape and reel

4 Revision history

Table 8: Document revision history

Date	Revision	Changes
16-Sep-2005	1	First issue.
16-May-2017	2	Updated features, package silhouette and Table 1: "Device summary" . Updated Section 1: "Characteristics" , Section 1.1: "Characteristics (curves)" , Section 2: "Package information" and Table 7: "Ordering information" .

IMPORTANT NOTICE – PLEASE READ CAREFULLY

STMicroelectronics NV and its subsidiaries ("ST") reserve the right to make changes, corrections, enhancements, modifications, and improvements to ST products and/or to this document at any time without notice. Purchasers should obtain the latest relevant information on ST products before placing orders. ST products are sold pursuant to ST's terms and conditions of sale in place at the time of order acknowledgement.

Purchasers are solely responsible for the choice, selection, and use of ST products and ST assumes no liability for application assistance or the design of Purchasers' products.

No license, express or implied, to any intellectual property right is granted by ST herein.

Resale of ST products with provisions different from the information set forth herein shall void any warranty granted by ST for such product.

ST and the ST logo are trademarks of ST. All other product or service names are the property of their respective owners.

Information in this document supersedes and replaces information previously supplied in any prior versions of this document.

© 2017 STMicroelectronics – All rights reserved