

RIF-0-OSC-24DC/48DC/100 - Solid-state relay module



2905658

<https://www.phoenixcontact.com/us/products/2905658>

Please be informed that the data shown in this PDF document is generated from our online catalog. Please find the complete data in the user documentation. Our general terms of use for downloads are valid.



Pre-assembled solid-state relay module with screw connection, consisting of: relay base with ejector and plug-in miniature solid-state relay. Input voltage: 24 V DC. Output: 3 - 48 V DC/100 mA

Product description

The pluggable electromechanical and solid-state relays in the RIFLINE complete product range and the base are recognized and approved in accordance with UL 508. The relevant approvals can be called up at the individual components in question.

Commercial data

Item number	2905658
Packing unit	10 pc
Minimum order quantity	10 pc
Note	Made to order (non-returnable)
Sales key	C465
Product key	CK651J
Catalog page	Page 325 (C-5-2019)
GTIN	4046356983471
Weight per piece (including packing)	25.14 g
Weight per piece (excluding packing)	25 g
Customs tariff number	85364110
Country of origin	HU

RIF-0-OSC-24DC/48DC/100 - Solid-state relay module



2905658

<https://www.phoenixcontact.com/us/products/2905658>

Set consists of

RIF-0-BSC/ 1 - Relay base

2901872

<https://www.phoenixcontact.com/us/products/2901872>



RIF-0... relay base, for miniature power relay with 1 N/O contact or identical solid-state relays, screw connection, for mounting on NS 35/7,5

OPT-24DC/ 48DC/100 - Miniature solid-state relay

2966618

<https://www.phoenixcontact.com/us/products/2966618>

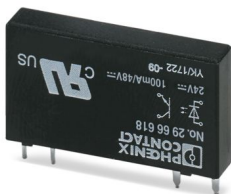

Plug-in miniature solid-state relay, input solid-state relay, 1 N/O contact, input: 24 V DC, output: 3 - 48 V DC/100 mA

Technical data

Product properties

Product type	Solid-state relay module
Product family	RIFLINE complete
Application	Universal
Operating mode	100% operating factor

Data management status

Date of last data management	10.06.2024
Article revision	03

Insulation characteristics: Air clearances and creepage distances between the power circuits

Insulation	Basic insulation
Overvoltage category	III
Pollution degree	2

Electrical properties

Maximum power dissipation for nominal condition	0.2 W
Test voltage (Input/output)	2.5 kV _{rms} (50 Hz, 1 min., input/output)

Air clearances and creepage distances between the power circuits

Rated insulation voltage	250 V AC
Rated surge voltage	4 kV

Input data

Rated actuating voltage U_C	24 V DC
Voltage range with reference to U_C	0.8 ... 1.2
Rated actuating current I_C	8.5 mA
Input voltage range	19.2 V DC ... 28.8 V DC
"0" signal switching threshold in reference to U_C	< 0.4
"1" signal switching threshold in reference to U_C	> 0.8
Typical response time	20 μ s
Typical turn-off time	300 μ s
Status display	LED (yellow)
Protective circuit	Freewheeling diode
Transmission frequency	300 Hz

Output data

Contact switching type	1 N/O contact
Design of digital output	electronic
Output voltage range	3 V DC ... 48 V DC
Limiting continuous current	100 mA
Surge voltage protection	> 56 V
Voltage drop at max. limiting continuous current	< 1 V

RIF-0-OSC-24DC/48DC/100 - Solid-state relay module



2905658

<https://www.phoenixcontact.com/us/products/2905658>

Output circuit	2-conductor, floating
Protective circuit	Reverse polarity protection
	Surge protection
Utilization category CB Scheme (IEC 60947-5-1)	DC12, 0.1 A/24 V

Connection data

Connection method	Screw connection
Stripping length	7 mm
Conductor cross section rigid	0.5 mm ² ... 4 mm ²
Conductor cross-section rigid (2 conductors with same cross section)	0.5 mm ² ... 1.5 mm ²
Conductor cross section flexible	0.5 mm ² ... 2.5 mm ²
	0.5 mm ² ... 2.5 mm ² (Ferrule without plastic sleeve)
	0.5 mm ² ... 1.5 mm ² (Ferrule with plastic sleeve)
Conductor cross section flexible (2 conductors with same cross section)	0.5 mm ² ... 1.5 mm ²
	0.5 mm ² ... 1 mm ² (TWIN ferrule with plastic sleeve)
Conductor cross section AWG	20 ... 12 (solid)
	20 ... 14 (flexible)
Tightening torque	0.5 Nm ... 0.6 Nm

Dimensions

Width	6.2 mm
Height	84 mm
Depth	68 mm

Material specifications

Color	gray (RAL 7042)
Flammability rating according to UL 94	V2 (Housing)

Environmental and real-life conditions

Ambient conditions

Degree of protection	IP20
Ambient temperature (operation)	-25 °C ... 60 °C
Ambient temperature (storage/transport)	-40 °C ... 85 °C

Approvals

Corrosive gas test

Identification	ISA-S71.04. G3 Harsh Group
	EN 60068-2-60

Standards and regulations

Air clearances and creepage distances between the power circuits

Standards/regulations	DIN EN 60947-5-1
-----------------------	------------------

2905658

<https://www.phoenixcontact.com/us/products/2905658>

Mounting

Mounting type	DIN rail mounting
Assembly note	in rows with zero spacing
Mounting position	any

Drawings

Circuit diagram

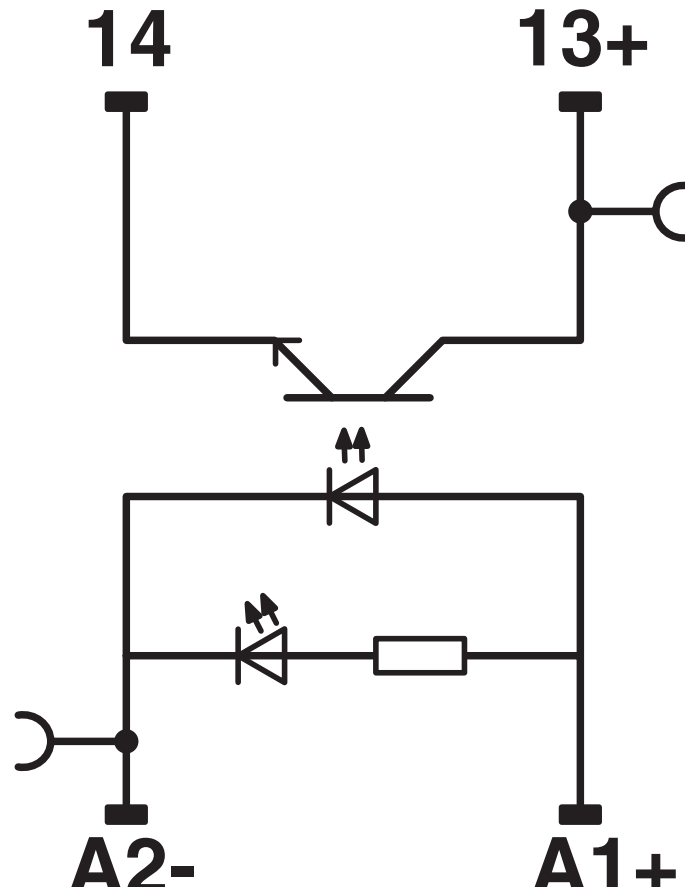

2905658

<https://www.phoenixcontact.com/us/products/2905658>

Approvals

 To download certificates, visit the product detail page: <https://www.phoenixcontact.com/us/products/2905658>



EAC

Approval ID: TR_TS_D_00573_c



DNV GL

Approval ID: TAA000018V

2905658

<https://www.phoenixcontact.com/us/products/2905658>

Classifications

ECLASS

ECLASS-11.0	27371604
ECLASS-13.0	27371604
ECLASS-12.0	27371604

ETIM

ETIM 9.0	EC001504
----------	----------

UNSPSC

UNSPSC 21.0	39122300
-------------	----------

2905658

<https://www.phoenixcontact.com/us/products/2905658>

Environmental product compliance

EU RoHS

Fulfills EU RoHS substance requirements	Yes
Exemption	7(a)

China RoHS

Environment friendly use period (EFUP)	EFUP-50
	An article-related China RoHS declaration table can be found in the download area for the respective article under "Manufacturer declaration". For all articles with EFUP-E, no China RoHS declaration table issued and required.

EU REACH SVHC

REACH candidate substance (CAS No.)	Lead(CAS: 7439-92-1)
SCIP	43f5c27b-3b19-4330-867c-ce81c72d2c79

2905658

<https://www.phoenixcontact.com/us/products/2905658>

Accessories

FBS 2-6 - Plug-in bridge

3030336

<https://www.phoenixcontact.com/us/products/3030336>



Plug-in bridge, pitch: 6.2 mm, number of positions: 2, color: red

FBS 3-6 - Plug-in bridge

3030242

<https://www.phoenixcontact.com/us/products/3030242>



Plug-in bridge, pitch: 6.2 mm, number of positions: 3, color: red

RIF-0-OSC-24DC/48DC/100 - Solid-state relay module



2905658

<https://www.phoenixcontact.com/us/products/2905658>

FBS 4-6 - Plug-in bridge

3030255

<https://www.phoenixcontact.com/us/products/3030255>



Plug-in bridge, pitch: 6.2 mm, number of positions: 4, color: red

FBS 5-6 - Plug-in bridge

3030349

<https://www.phoenixcontact.com/us/products/3030349>



Plug-in bridge, pitch: 6.2 mm, number of positions: 5, color: red

RIF-0-OSC-24DC/48DC/100 - Solid-state relay module



2905658

<https://www.phoenixcontact.com/us/products/2905658>

FBS 10-6 - Plug-in bridge

3030271

<https://www.phoenixcontact.com/us/products/3030271>



Plug-in bridge, pitch: 6.2 mm, number of positions: 10, color: red

FBS 20-6 - Plug-in bridge

3030365

<https://www.phoenixcontact.com/us/products/3030365>



Plug-in bridge, pitch: 6.2 mm, number of positions: 20, color: red

RIF-0-OSC-24DC/48DC/100 - Solid-state relay module



2905658

<https://www.phoenixcontact.com/us/products/2905658>

FBS 50-6 - Plug-in bridge

3032224

<https://www.phoenixcontact.com/us/products/3032224>



Plug-in bridge, pitch: 6.2 mm, number of positions: 50, color: red

FBS 2-6 BU - Plug-in bridge

3036932

<https://www.phoenixcontact.com/us/products/3036932>



Plug-in bridge, pitch: 6.2 mm, number of positions: 2, color: blue

RIF-0-OSC-24DC/48DC/100 - Solid-state relay module



2905658

<https://www.phoenixcontact.com/us/products/2905658>

FBS 3-6 BU - Plug-in bridge

3036945

<https://www.phoenixcontact.com/us/products/3036945>



Plug-in bridge, pitch: 6.2 mm, number of positions: 3, color: blue

FBS 4-6 BU - Plug-in bridge

3036958

<https://www.phoenixcontact.com/us/products/3036958>



Plug-in bridge, pitch: 6.2 mm, number of positions: 4, color: blue

RIF-0-OSC-24DC/48DC/100 - Solid-state relay module



2905658

<https://www.phoenixcontact.com/us/products/2905658>

FBS 5-6 BU - Plug-in bridge

3036961

<https://www.phoenixcontact.com/us/products/3036961>



Plug-in bridge, pitch: 6.2 mm, number of positions: 5, color: blue

FBS 10-6 BU - Plug-in bridge

3032198

<https://www.phoenixcontact.com/us/products/3032198>



Plug-in bridge, pitch: 6.2 mm, number of positions: 10, color: blue

RIF-0-OSC-24DC/48DC/100 - Solid-state relay module



2905658

<https://www.phoenixcontact.com/us/products/2905658>

FBS 20-6 BU - Plug-in bridge

3032208

<https://www.phoenixcontact.com/us/products/3032208>

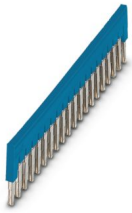

Plug-in bridge, pitch: 6.2 mm, number of positions: 20, color: blue

FBS 50-6 BU - Plug-in bridge

3032211

<https://www.phoenixcontact.com/us/products/3032211>



Plug-in bridge, pitch: 6.2 mm, number of positions: 50, color: blue

RIF-0-OSC-24DC/48DC/100 - Solid-state relay module



2905658

<https://www.phoenixcontact.com/us/products/2905658>

FBS 2-6 GY - Plug-in bridge

3032237

<https://www.phoenixcontact.com/us/products/3032237>



Plug-in bridge, pitch: 6.2 mm, number of positions: 2, color: gray

FBS 3-6 GY - Plug-in bridge

3032240

<https://www.phoenixcontact.com/us/products/3032240>



Plug-in bridge, pitch: 6.2 mm, number of positions: 3, color: gray

RIF-0-OSC-24DC/48DC/100 - Solid-state relay module



2905658

<https://www.phoenixcontact.com/us/products/2905658>

FBS 4-6 GY - Plug-in bridge

3032279

<https://www.phoenixcontact.com/us/products/3032279>



Plug-in bridge, pitch: 6.2 mm, number of positions: 4, color: gray

FBS 5-6 GY - Plug-in bridge

3032266

<https://www.phoenixcontact.com/us/products/3032266>



Plug-in bridge, pitch: 6.2 mm, number of positions: 5, color: gray

RIF-0-OSC-24DC/48DC/100 - Solid-state relay module



2905658

<https://www.phoenixcontact.com/us/products/2905658>

FBS 10-6 GY - Plug-in bridge

3032253

<https://www.phoenixcontact.com/us/products/3032253>



Plug-in bridge, pitch: 6.2 mm, number of positions: 10, color: gray

NS 35/ 7,5 PERF 2000MM - DIN rail perforated

0801733

<https://www.phoenixcontact.com/us/products/0801733>



DIN rail perforated, Pack of 25 (50 m), acc. to EN 60715, material: Steel, galvanized, passivated with a thick layer, Standard profile, color: silver

RIF-0-OSC-24DC/48DC/100 - Solid-state relay module



2905658

<https://www.phoenixcontact.com/us/products/2905658>

NS 35/ 7,5 UNPERF 2000MM - DIN rail, unperforated

0801681

<https://www.phoenixcontact.com/us/products/0801681>



DIN rail, unperforated, Pack of 25 (50 m), acc. to EN 60715, material: Steel, galvanized, passivated with a thick layer, Standard profile, color: silver

NS 35/ 7,5 WH PERF 2000MM - DIN rail perforated

1204119

<https://www.phoenixcontact.com/us/products/1204119>



DIN rail perforated, Pack of 25 (50 m), acc. to EN 60715, material: Steel, Galvanized, white passivated, Standard profile, color: silver

RIF-0-OSC-24DC/48DC/100 - Solid-state relay module



2905658

<https://www.phoenixcontact.com/us/products/2905658>

NS 35/ 7,5 WH UNPERF 2000MM-VPE 10 - DIN rail, unperforated

1204122

<https://www.phoenixcontact.com/us/products/1204122>



DIN rail, unperforated, Pack of 10 (20 m), acc. to EN 60715, material: Steel, Galvanized, white passivated, Standard profile, color: silver

NS 35/ 7,5 AL UNPERF 2000MM - DIN rail, unperforated

0801704

<https://www.phoenixcontact.com/us/products/0801704>



DIN rail, unperforated, Pack of 25 (50 m), acc. to EN 60715, material: Aluminum, uncoated, Standard profile, color: silver

RIF-0-OSC-24DC/48DC/100 - Solid-state relay module



2905658

<https://www.phoenixcontact.com/us/products/2905658>

NS 35/ 7,5 ZN PERF 2000MM - DIN rail perforated

1206421

<https://www.phoenixcontact.com/us/products/1206421>



DIN rail perforated, Pack of 25 (50 m), acc. to EN 60715, material: Steel, galvanized, Standard profile, color: silver

NS 35/ 7,5 ZN UNPERF 2000MM - DIN rail, unperforated

1206434

<https://www.phoenixcontact.com/us/products/1206434>



DIN rail, unperforated, Pack of 25 (50 m), acc. to EN 60715, material: Steel, galvanized, Standard profile, color: silver

RIF-0-OSC-24DC/48DC/100 - Solid-state relay module



2905658

<https://www.phoenixcontact.com/us/products/2905658>

NS 35/ 7,5 CU UNPERF 2000MM-VPE 10 - DIN rail, unperforated

0801762

<https://www.phoenixcontact.com/us/products/0801762>



DIN rail, unperforated, Pack of 10 (20 m), acc. to EN 60715, material: Copper, uncoated, Standard profile, color: copper-colored

NS 35/ 7,5 CAP - End cap

1206560

<https://www.phoenixcontact.com/us/products/1206560>

DIN rail end piece, for DIN rail NS 35/7.5



RIF-0-OSC-24DC/48DC/100 - Solid-state relay module



2905658

<https://www.phoenixcontact.com/us/products/2905658>

NS 35/15 PERF 2000MM - DIN rail perforated

1201730

<https://www.phoenixcontact.com/us/products/1201730>



DIN rail perforated, Pack of 25 (50 m), similar to EN 60715, material: Steel, galvanized, passivated with a thick layer, Standard profile, color: silver

NS 35/15 UNPERF 2000MM - DIN rail, unperforated

1201714

<https://www.phoenixcontact.com/us/products/1201714>



DIN rail, unperforated, Pack of 25 (50 m), similar to EN 60715, material: Steel, galvanized, passivated with a thick layer, Standard profile, color: silver

RIF-0-OSC-24DC/48DC/100 - Solid-state relay module



2905658

<https://www.phoenixcontact.com/us/products/2905658>

NS 35/15 WH PERF 2000MM - DIN rail perforated

0806602

<https://www.phoenixcontact.com/us/products/0806602>



DIN rail perforated, Pack of 25 (50 m), similar to EN 60715, material: Steel, Galvanized, white passivated, Standard profile, color: white

NS 35/15 WH UNPERF 2000MM-VPE 10 - DIN rail, unperforated

1204135

<https://www.phoenixcontact.com/us/products/1204135>



DIN rail, unperforated, Pack of 10 (20 m), similar to EN 60715, material: Steel, Galvanized, white passivated, Standard profile, color: silver

RIF-0-OSC-24DC/48DC/100 - Solid-state relay module



2905658

<https://www.phoenixcontact.com/us/products/2905658>

NS 35/15 AL UNPERF 2000MM - DIN rail, unperforated

1201756

<https://www.phoenixcontact.com/us/products/1201756>



DIN rail, unperforated, similar to EN 60715, material: Aluminum, uncoated, Standard profile, color: silver

NS 35/15 ZN PERF 2000MM - DIN rail perforated

1206599

<https://www.phoenixcontact.com/us/products/1206599>



DIN rail perforated, Pack of 25 (50 m), similar to EN 60715, material: Steel, galvanized, Standard profile, color: silver

RIF-0-OSC-24DC/48DC/100 - Solid-state relay module



2905658

<https://www.phoenixcontact.com/us/products/2905658>

NS 35/15 ZN UNPERF 2000MM - DIN rail, unperforated

1206586

<https://www.phoenixcontact.com/us/products/1206586>



DIN rail, unperforated, Pack of 25 (50 m), similar to EN 60715, material: Steel, galvanized, Standard profile, color: silver

NS 35/15 CU UNPERF 2000MM-VPE 10 - DIN rail, unperforated

1201895

<https://www.phoenixcontact.com/us/products/1201895>



DIN rail, unperforated, Pack of 10 (20 m), similar to EN 60715, material: Copper, uncoated, Standard profile, color: copper-colored

RIF-0-OSC-24DC/48DC/100 - Solid-state relay module



2905658

<https://www.phoenixcontact.com/us/products/2905658>

NS 35/15 CAP - End cap

1206573

<https://www.phoenixcontact.com/us/products/1206573>

DIN rail end piece, for DIN rail NS 35/15



NS 35/15-2,3 UNPERF 2000MM-VPE 10 - DIN rail, unperforated

1201798

<https://www.phoenixcontact.com/us/products/1201798>

DIN rail, unperforated, Pack of 10 (20 m), acc. to EN 60715, material: Steel, galvanized, passivated with a thick layer, Standard profile 2.3 mm, color: silver



2905658

<https://www.phoenixcontact.com/us/products/2905658>

CLIPFIX 35 - End bracket

3022218

<https://www.phoenixcontact.com/us/products/3022218>



Quick mounting end clamp for NS 35/7,5 DIN rail or NS 35/15 DIN rail, with marking option, width: 9.5 mm, color: gray

CLIPFIX 35-5 - End bracket

3022276

<https://www.phoenixcontact.com/us/products/3022276>



Quick mounting end clamp for NS 35/7,5 DIN rail or NS 35/15 DIN rail, with marking option, with parking option for FBS...5, FBS...6, KSS 5, KSS 6, width: 5.15 mm, color: gray

RIF-0-OSC-24DC/48DC/100 - Solid-state relay module



2905658

<https://www.phoenixcontact.com/us/products/2905658>

E/NS 35 N - End bracket

0800886

<https://www.phoenixcontact.com/us/products/0800886>

End clamp, width: 9.5 mm, color: gray

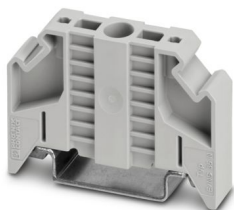

MPS-MT - Test plug

0201744

<https://www.phoenixcontact.com/us/products/0201744>

Test plug, with solder connection up to 1 mm² conductor cross section, number of positions: 1, color: gray



RIF-0-OSC-24DC/48DC/100 - Solid-state relay module



2905658

<https://www.phoenixcontact.com/us/products/2905658>

MPS-IH WH - Insulating sleeve

0201663

<https://www.phoenixcontact.com/us/products/0201663>

Insulating sleeve, color: white



MPS-IH RD - Insulating sleeve

0201676

<https://www.phoenixcontact.com/us/products/0201676>

Insulating sleeve, color: red



2905658

<https://www.phoenixcontact.com/us/products/2905658>

MPS-IH BU - Insulating sleeve

0201689

<https://www.phoenixcontact.com/us/products/0201689>

Insulating sleeve, color: blue

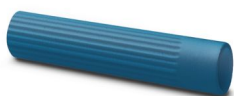

MPS-IH YE - Insulating sleeve

0201692

<https://www.phoenixcontact.com/us/products/0201692>

Insulating sleeve, color: yellow



RIF-0-OSC-24DC/48DC/100 - Solid-state relay module



2905658

<https://www.phoenixcontact.com/us/products/2905658>

MPS-IH GN - Insulating sleeve

0201702

<https://www.phoenixcontact.com/us/products/0201702>

Insulating sleeve, color: green



MPS-IH GY - Insulating sleeve

0201728

<https://www.phoenixcontact.com/us/products/0201728>

Insulating sleeve, color: gray



RIF-0-OSC-24DC/48DC/100 - Solid-state relay module



2905658

<https://www.phoenixcontact.com/us/products/2905658>

MPS-IH BK - Insulating sleeve

0201731

<https://www.phoenixcontact.com/us/products/0201731>

Insulating sleeve, color: black



ZB 6:UNBEDRUCKT - Zack marker strip

1051003

<https://www.phoenixcontact.com/us/products/1051003>



Zack marker strip, Strip, white, unlabeled, can be labeled with: PLOTMARK, CMS-P1-PLOTTER, mounting type: snapped, for terminal block width: 6.2 mm, lettering field size: 6.15 x 10.5 mm, Number of individual labels: 10

RIF-0-OSC-24DC/48DC/100 - Solid-state relay module



2905658

<https://www.phoenixcontact.com/us/products/2905658>

ZB 6 CUS - Zack marker strip

0824992

<https://www.phoenixcontact.com/us/products/0824992>



Zack marker strip, can be ordered: Strip, white, labeled according to customer specifications, mounting type: snap into tall marker groove, for terminal block width: 6.2 mm, lettering field size: 6.15 x 10.5 mm, Number of individual labels: 10

ZB 6,LGS:FORTL.ZAHLEN - Zack marker strip

1051016

<https://www.phoenixcontact.com/us/products/1051016>



Zack marker strip, Strip, white, labeled, can be labeled with: CMS-P1-PLOTTER, printed horizontally: consecutive numbers 1 ... 10, 11 ... 20, etc. up to 491 ... 500, mounting type: snapped, for terminal block width: 6.2 mm, lettering field size: 6.15 x 10.5 mm, Number of individual labels: 10

RIF-0-OSC-24DC/48DC/100 - Solid-state relay module



2905658

<https://www.phoenixcontact.com/us/products/2905658>

ZB 6,QR:FORTL.ZAHLEN - Zack marker strip

1051029

<https://www.phoenixcontact.com/us/products/1051029>

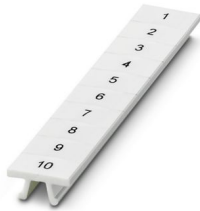

Zack marker strip, Strip, white, labeled, can be labeled with: CMS-P1-PLOTTER, Printed vertically: consecutive numbers 1 ... 10, 11 ... 20, etc. up to 491 ... 500, mounting type: snapped, for terminal block width: 6.2 mm, lettering field size: 6.15 x 10.5 mm, Number of individual labels: 10

ZB 6,LGS:GLEICHE ZAHLEN - Zack marker strip

1051032

<https://www.phoenixcontact.com/us/products/1051032>



Zack marker strip, Strip, white, labeled, can be labeled with: CMS-P1-PLOTTER, printed horizontally: Identical numbers 1 or 2, etc. up to 100, mounting type: snapped, for terminal block width: 6.2 mm, lettering field size: 6.15 x 10.5 mm, Number of individual labels: 10

2905658

<https://www.phoenixcontact.com/us/products/2905658>

ZB 6,LGS:L1-N,PE - Marker for terminal blocks

1051414

<https://www.phoenixcontact.com/us/products/1051414>



Marker for terminal blocks, Strip, white, labeled, can be labeled with: CMS-P1-PLOTTER, horizontal: L1, L2, L3, N, PE, L1, L2, L3, N, PE, mounting type: snapped, for terminal block width: 6.2 mm, lettering field size: 6.15 x 10.5 mm, Number of individual labels: 10

ZB 6,LGS:U-N - Marker for terminal blocks

1051430

<https://www.phoenixcontact.com/us/products/1051430>



Marker for terminal blocks, Strip, white, labeled, can be labeled with: CMS-P1-PLOTTER, printed horizontally: U, V, W, N, GND, U, V, W, N, GND, mounting type: snapped, for terminal block width: 6.2 mm, lettering field size: 6.15 x 10.5 mm, Number of individual labels: 10

2905658

<https://www.phoenixcontact.com/us/products/2905658>

UC-TM 6 - Marker for terminal blocks

0818085

<https://www.phoenixcontact.com/us/products/0818085>



Marker for terminal blocks, Sheet, white, unlabeled, can be labeled with: BLUEMARK ID COLOR, BLUEMARK ID, BLUEMARK CLED, PLOTMARK, CMS-P1-PLOTTER, mounting type: snapped, for terminal block width: 6.2 mm, lettering field size: 5.6 x 10.5 mm, Number of individual labels: 80

UC-TM 6 CUS - Marker for terminal blocks

0824589

<https://www.phoenixcontact.com/us/products/0824589>



Marker for terminal blocks, can be ordered: by sheet, white, labeled according to customer specifications, mounting type: snap into tall marker groove, for terminal block width: 6.2 mm, lettering field size: 5.6 x 10.5 mm, Number of individual labels: 80

2905658

<https://www.phoenixcontact.com/us/products/2905658>

UCT-TM 6 - Marker for terminal blocks

0828736

<https://www.phoenixcontact.com/us/products/0828736>



Marker for terminal blocks, Sheet, white, unlabeled, can be labeled with: TOPMARK NEO, TOPMARK LASER, BLUEMARK ID COLOR, BLUEMARK ID, BLUEMARK CLED, THERMOMARK PRIME, THERMOMARK CARD 2.0, THERMOMARK CARD, mounting type: snapped, for terminal block width: 6.2 mm, lettering field size: 5.6 x 10.5 mm, Number of individual labels: 60

UCT-TM 6 CUS - Marker for terminal blocks

0829602

<https://www.phoenixcontact.com/us/products/0829602>



Marker for terminal blocks, can be ordered: by sheet, white, labeled according to customer specifications, mounting type: snap into tall marker groove, for terminal block width: 6.2 mm, lettering field size: 5.6 x 10.5 mm, Number of individual labels: 60

RIF-0-OSC-24DC/48DC/100 - Solid-state relay module



2905658

<https://www.phoenixcontact.com/us/products/2905658>

OPT-24DC/ 48DC/100 - Miniature solid-state relay

2966618

<https://www.phoenixcontact.com/us/products/2966618>

Plug-in miniature solid-state relay, input solid-state relay, 1 N/O contact, input: 24 V DC, output: 3 - 48 V DC/100 mA

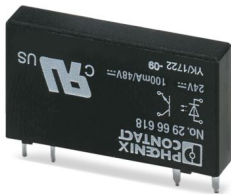

RIF-0-BSC/ 1 - Relay base

2901872

<https://www.phoenixcontact.com/us/products/2901872>

RIF-0... relay base, for miniature power relay with 1 N/O contact or identical solid-state relays, screw connection, for mounting on NS 35/7,5



Phoenix Contact 2024 © - all rights reserved
<https://www.phoenixcontact.com>

Phoenix Contact USA
586 Fulling Mill Road
Middletown, PA 17057, United States
(+717) 944-1300
info@phoenixcon.com