



## MMIC SURFACE MOUNT

# Power Splitter/Combiner

## WP4A+

Mini-Circuits

4 Way-0° 50Ω 5100 to 6500 MHz

### FEATURES

- Excellent isolation, 25 dB typ.
- Good phase unbalance, 3 deg. typ.
- Good amplitude unbalance, 0.15 dB typ.
- Small size, .118" x .118" x .035"
- High ESD level
- Aqueous washable

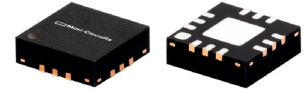

Generic photo used for illustration purposes only

CASE STYLE: DQ1225

**+RoHS Compliant**

The +Suffix identifies RoHS Compliance. See our website for methodologies and qualifications

### APPLICATIONS

- WLAN
- WIMAX
- ISM
- Radar
- Satellite up-link

### ELECTRICAL SPECIFICATIONS AT 25°C

Parameter	Frequency (MHz)	Min.	Typ.	Max.	Units
Frequency Range		5100		6500	MHz
Insertion Loss* (above 6.0 dB)	5100-6500	—	0.9	2.0	dB
Isolation	5100-6500	15	25	—	dB
Amplitude Unbalance	5100-6500	—	—	0.5	dB
Phase Unbalance	5100-6500	—	—	8	deg.
VSWR (Port S)	5100-6500	—	1.5	—	:1
VSWR (Ports 1,2,3,4)	5100-6500	—	1.6	—	:1

\* Includes fixture loss, 0.3 dB typ.

### MAXIMUM RATINGS

Parameter	Ratings
Operating temperature	-40°C to 85°C
Storage temperature	-65°C to 150°C
Power Input (as a splitter)	1.5W max.
Internal Dissipation	0.375W max.

Permanent damage may occur if any of these limits are exceeded.

### ELECTRICAL SCHEMATIC

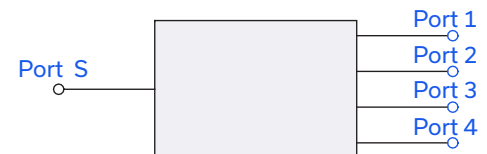

REV. D  
ECO-015507  
WP4A+  
MCL NY  
230404





### PAD CONNECTIONS

SUM PORT	2
PORT 1	12
PORT 2	10
PORT 3	6
PORT 4	4
GROUND	1,3,5,7,8,9,11, paddle

### DEMO BOARD MCL P/N: TB-395+ SUGGESTED PCB LAYOUT (PL-259)

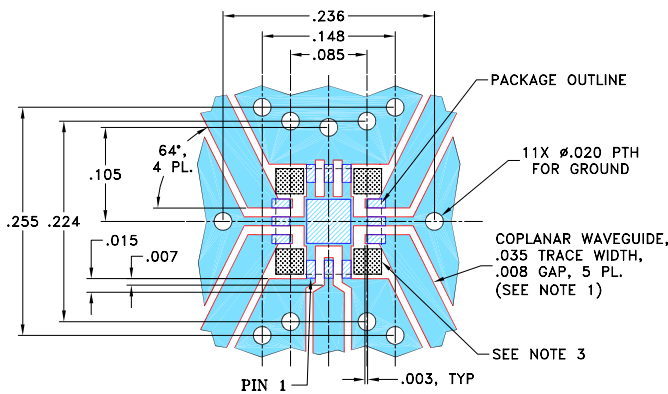

**NOTES:**

1. TRACE WIDTH IS SHOWN FOR ROGERS R04350B WITH DIELECTRIC THICKNESS .020" ± .0015"; COPPER: 1/2 OZ. EACH SIDE. FOR OTHER MATERIALS TRACE WIDTH AND GAP MAY NEED TO BE MODIFIED.
2. BOTTOM SIDE OF THE PCB IS CONTINUOUS GROUND PLANE.
3. SIGNAL TRACES ARE NOT ALLOWED INSIDE HATCHED AREAS (APPROX. .030 X .030) AT 4 PLACES AS SHOWN.

- DENOTES PCB COPPER LAYOUT WITH SMOBC (SOLDER MASK OVER BARE COPPER)
- DENOTES COPPER LAND PATTERN FREE OF SOLDER MASK

### OUTLINE DRAWING

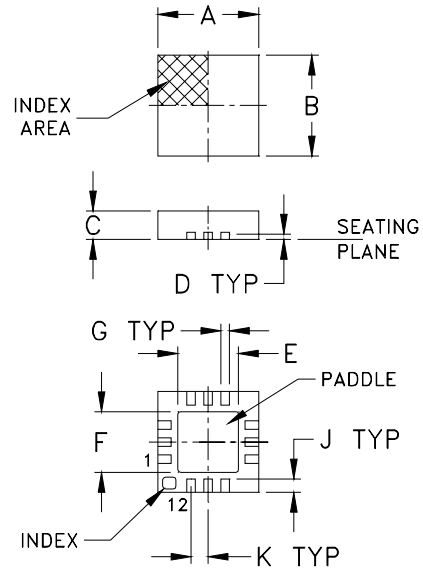

### PCB Land Pattern

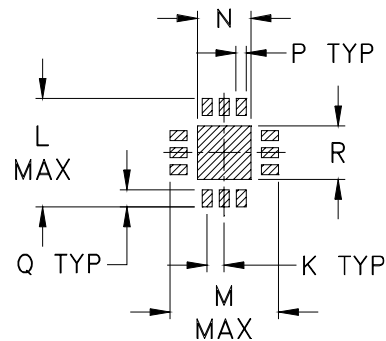

Suggested Layout,  
Tolerance to be within ±.002

### PRODUCT MARKING

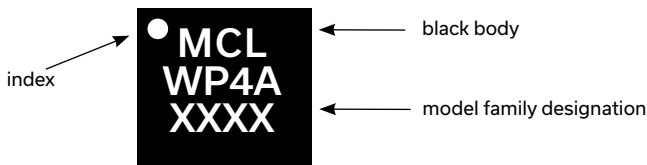

Marking may contain other features or characters for internal lot control

### OUTLINE DIMENSIONS (Inch/mm)

A	B	C	D	E	F	G	H	J
.118	.118	.035	.008	.057	.057	.009	---	.016
3.00	3.00	0.89	0.20	1.45	1.45	0.23	---	0.41
K	L	M	N	P	Q	R		wt
.020	.127	.127	.049	.010	.020	.049		grams
0.51	3.23	3.23	1.24	0.25	0.51	1.24		0.02

### TAPE & REEL INFORMATION: F66



### TYPICAL PERFORMANCE DATA AND CHARTS

Frequency (MHz)	Total Loss <sup>1</sup> (dB)				Amplitude Unbalance (dB)	Isolation (dB)			Phase Unbalance (deg.)	VSWR S	VSWR 1	VSWR 2	VSWR 3	VSWR 4
	S-1	S-2	S-3	S-4		1-2	2-3	3-4						
5100.00	7.24	7.16	7.15	7.22	0.09	28.47	27.87	28.48	4.01	1.61	1.72	1.81	1.84	1.75
5200.00	7.15	7.08	7.06	7.13	0.09	28.69	27.96	28.64	3.84	1.51	1.69	1.76	1.78	1.72
5300.00	7.09	7.00	6.99	7.07	0.09	28.63	27.76	28.55	3.65	1.42	1.66	1.71	1.73	1.69
5400.00	7.03	6.94	6.94	7.02	0.09	28.35	27.32	28.23	3.40	1.35	1.63	1.67	1.69	1.66
5500.00	7.00	6.90	6.89	6.98	0.10	27.89	26.71	27.76	3.17	1.29	1.61	1.63	1.64	1.63
5600.00	6.97	6.88	6.86	6.95	0.11	27.34	26.01	27.19	2.96	1.26	1.58	1.59	1.60	1.60
5700.00	6.96	6.87	6.84	6.94	0.12	26.75	25.25	26.57	2.71	1.26	1.55	1.55	1.56	1.58
5800.00	6.97	6.87	6.84	6.96	0.13	26.16	24.51	25.97	2.53	1.29	1.54	1.52	1.53	1.57
5825.00	6.97	6.87	6.84	6.95	0.13	26.00	24.33	25.81	2.42	1.29	1.53	1.52	1.52	1.56
5875.00	6.99	6.89	6.85	6.97	0.14	25.71	23.97	25.51	2.35	1.32	1.52	1.50	1.51	1.55
5900.00	6.99	6.90	6.85	6.97	0.14	25.57	23.80	25.37	2.33	1.33	1.52	1.50	1.50	1.55
6000.00	7.01	6.93	6.87	6.99	0.15	24.99	23.11	24.79	2.18	1.39	1.50	1.47	1.47	1.52

1. Total Loss = Insertion Loss + 6dB splitter loss.

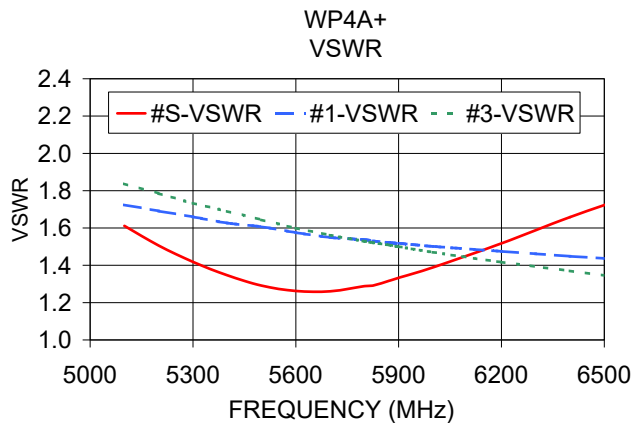
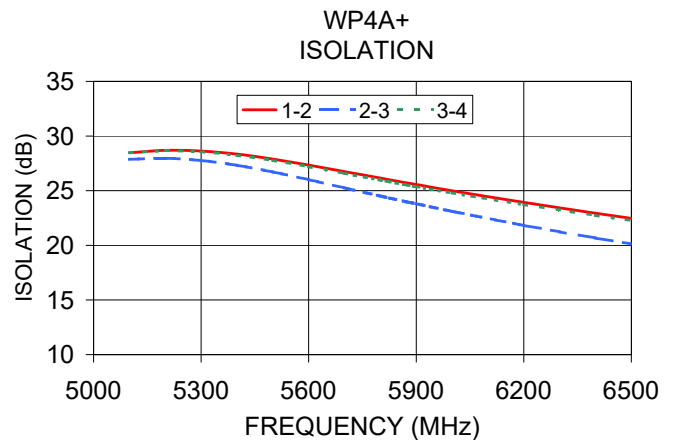
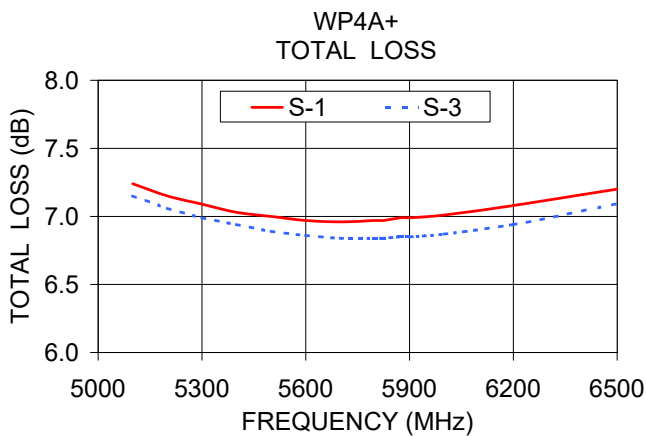

#### NOTES

- A. Performance and quality attributes and conditions not expressly stated in this specification document are intended to be excluded and do not form a part of this specification document.
- B. Electrical specifications and performance data contained in this specification document are based on Mini-Circuit's applicable established test performance criteria and measurement instructions.
- C. The parts covered by this specification document are subject to Mini-Circuits standard limited warranty and terms and conditions (collectively, "Standard Terms"); Purchasers of this part are entitled to the rights and benefits contained therein. For a full statement of the standard terms and the exclusive rights and remedies thereunder, please visit Mini-Circuits' website at [www.minicircuits.com/terms/viewterm.html](http://www.minicircuits.com/terms/viewterm.html)



# 4 Way-0° Power Splitter/Combiner

# WP4A+

## Typical Performance Data

TEST CONDITIONS: INPUT POWER = -10dBm @Temperature = +25°C

FREQ. (MHz)	TOTAL LOSS <sup>1</sup> (dB)				AMP. UNBAL. (dB)	PHASE UNBAL. (deg.)	ISOLATION (dB)			VSWR (:1)				
	S-1	S-2	S-3	S-4			1-2	2-3	3-4	S	1	2	3	4
4000	8.90	8.92	8.92	8.87	0.06	5.78	21.28	21.37	21.45	4.56	2.31	2.59	2.62	2.27
4200	8.77	8.80	8.78	8.73	0.07	5.37	22.28	22.32	22.45	3.81	2.22	2.43	2.48	2.17
4400	8.75	8.75	8.74	8.72	0.03	5.24	23.50	23.37	23.75	3.18	2.12	2.30	2.33	2.07
4500	8.36	8.35	8.37	8.32	0.05	4.58	24.29	24.01	24.41	2.90	2.07	2.22	2.25	2.02
4700	7.68	7.61	7.62	7.63	0.07	3.91	26.08	25.58	25.97	2.42	1.98	2.07	2.11	1.92
4800	7.72	7.65	7.68	7.67	0.07	3.85	27.00	26.28	26.93	2.21	1.93	1.99	2.03	1.87
4900	7.43	7.32	7.31	7.38	0.11	3.63	27.96	27.10	27.75	2.03	1.89	1.92	1.97	1.82
4950	7.66	7.55	7.57	7.60	0.11	3.84	28.40	27.64	28.18	1.95	1.86	1.90	1.93	1.81
5000	7.36	7.25	7.25	7.30	0.11	3.51	28.78	28.04	28.65	1.86	1.85	1.86	1.90	1.78
5050	7.28	7.16	7.16	7.23	0.12	3.36	29.38	28.32	29.19	1.79	1.82	1.85	1.88	1.77
5100	7.35	7.18	7.18	7.28	0.16	3.38	29.67	28.79	29.47	1.72	1.80	1.81	1.84	1.75
5150	7.26	7.14	7.16	7.20	0.11	3.26	29.96	29.10	29.80	1.65	1.79	1.78	1.82	1.73
5200	7.14	6.98	6.99	7.08	0.16	3.00	30.12	29.41	30.03	1.59	1.76	1.77	1.78	1.71
5250	7.12	6.97	6.97	7.07	0.15	2.97	30.24	29.47	30.24	1.54	1.75	1.72	1.76	1.69
5300	7.16	7.01	7.02	7.10	0.15	2.99	30.25	29.61	30.27	1.49	1.73	1.72	1.74	1.68
5350	7.00	6.85	6.85	6.95	0.15	2.72	30.31	29.55	30.20	1.44	1.71	1.69	1.70	1.65
5400	7.02	6.86	6.88	6.97	0.16	2.69	30.19	29.50	30.20	1.41	1.70	1.66	1.69	1.64
5450	7.01	6.84	6.85	6.96	0.17	2.62	29.86	29.15	30.07	1.37	1.69	1.64	1.65	1.62
5500	6.93	6.79	6.79	6.89	0.14	2.54	29.70	28.75	29.69	1.34	1.66	1.62	1.64	1.60
5550	6.92	6.76	6.76	6.88	0.16	2.41	29.41	28.38	29.57	1.32	1.66	1.59	1.62	1.60
5600	6.91	6.75	6.75	6.86	0.17	2.22	29.22	27.85	29.19	1.31	1.65	1.57	1.59	1.58
5650	6.92	6.76	6.75	6.87	0.17	2.16	29.12	27.40	28.77	1.31	1.63	1.57	1.58	1.56
5700	6.88	6.72	6.72	6.83	0.16	1.99	28.68	26.87	28.26	1.31	1.62	1.53	1.56	1.55
5750	6.89	6.73	6.71	6.84	0.18	1.88	28.40	26.75	27.82	1.32	1.61	1.53	1.54	1.54
5800	6.88	6.73	6.71	6.84	0.17	1.75	28.08	25.94	27.51	1.32	1.60	1.50	1.53	1.53
5850	6.87	6.71	6.69	6.81	0.18	1.65	27.74	25.50	27.14	1.35	1.60	1.49	1.50	1.51
5900	6.90	6.76	6.74	6.86	0.15	1.45	27.35	24.85	26.67	1.37	1.58	1.47	1.50	1.51
5950	6.85	6.70	6.68	6.80	0.17	1.33	26.98	24.47	26.08	1.39	1.57	1.46	1.48	1.49
6000	6.87	6.73	6.71	6.83	0.16	1.23	26.42	24.00	25.82	1.42	1.57	1.45	1.46	1.49
6050	6.94	6.79	6.77	6.89	0.16	1.13	26.04	23.60	25.39	1.45	1.55	1.42	1.45	1.47
6100	6.86	6.74	6.73	6.83	0.13	1.02	25.72	23.06	24.89	1.48	1.55	1.42	1.43	1.47
6150	6.92	6.80	6.78	6.89	0.14	0.83	25.21	22.80	24.67	1.51	1.54	1.40	1.42	1.47
6200	6.92	6.81	6.79	6.88	0.13	0.80	24.95	22.34	24.29	1.55	1.53	1.39	1.41	1.45
6250	7.00	6.90	6.88	6.97	0.13	0.86	24.51	22.00	23.99	1.58	1.53	1.39	1.40	1.45
6300	6.90	6.82	6.79	6.87	0.11	0.82	24.24	21.61	23.68	1.62	1.52	1.36	1.39	1.45
6350	7.02	6.91	6.90	6.99	0.11	0.80	23.76	21.40	23.33	1.65	1.52	1.36	1.37	1.45
6400	7.10	6.99	6.99	7.07	0.11	0.99	23.49	21.09	23.01	1.69	1.51	1.34	1.37	1.44
6450	6.98	6.92	6.94	6.96	0.06	0.90	23.24	20.59	22.75	1.72	1.50	1.34	1.36	1.44
6500	7.06	6.99	6.97	7.05	0.08	1.40	22.89	20.43	22.49	1.76	1.50	1.33	1.34	1.44
6550	7.16	7.10	7.09	7.14	0.07	1.28	22.65	20.28	21.99	1.79	1.49	1.32	1.34	1.44
6600	7.14	7.09	7.09	7.12	0.05	1.38	22.41	19.95	21.87	1.83	1.48	1.32	1.33	1.44
6650	7.03	7.04	7.02	7.02	0.02	1.83	22.16	19.73	21.63	1.86	1.48	1.31	1.32	1.44
6700	7.33	7.27	7.26	7.30	0.07	1.66	21.94	19.50	21.41	1.89	1.47	1.30	1.31	1.44
6800	7.20	7.20	7.22	7.20	0.02	1.92	21.64	19.07	21.00	1.95	1.46	1.29	1.30	1.44
6900	7.40	7.38	7.41	7.38	0.03	2.14	21.25	18.66	20.57	2.01	1.45	1.27	1.28	1.43
7000	7.34	7.38	7.39	7.33	0.07	2.93	20.93	18.26	20.29	2.06	1.43	1.25	1.27	1.43
7200	7.46	7.56	7.56	7.44	0.13	3.64	20.37	17.36	19.67	2.16	1.40	1.23	1.25	1.42
7400	7.75	7.75	7.76	7.69	0.07	3.84	19.68	16.72	19.10	2.26	1.39	1.23	1.23	1.41
7600	7.61	7.68	7.70	7.52	0.17	3.74	19.04	15.96	18.70	2.34	1.38	1.23	1.23	1.40
7800	7.52	7.70	7.66	7.42	0.27	4.12	18.53	15.22	18.31	2.42	1.36	1.23	1.23	1.38
8000	7.51	7.71	7.61	7.37	0.34	4.47	17.85	14.72	17.87	2.51	1.36	1.26	1.25	1.37
8200	7.96	8.00	7.88	7.81	0.19	6.08	17.15	14.24	17.55	2.61	1.37	1.28	1.28	1.35
8400	8.03	7.93	7.85	7.87	0.18	5.98	16.68	13.85	17.32	2.71	1.36	1.29	1.30	1.33
8500	7.78	7.82	7.67	7.64	0.18	5.25	16.49	13.60	17.25	2.78	1.36	1.31	1.32	1.32

<sup>1</sup> Total Loss = Insertion Loss+ 6dB Splitter Loss

REV. X2  
WP4A+  
100627

Page 1 of 3



IR/RF MICROWAVE COMPONENTS • ISO 9001 ISO 14001 AS 9100 CERTIFIED • RoHS compliant  
P.O. Box 350166, Brooklyn, New York 11235-0006 (718) 934-4500 Fax (718) 332-4661



The Design Engineers Search Engine finds the model you need, Instantly • For detailed performance specs & shopping online see



# 4 Way-0° Power Splitter/Combiner

# WP4A+

## Typical Performance Data

TEST CONDITIONS: INPUT POWER = -10dBm @Temperature = -40°C

FREQ. (MHz)	TOTAL LOSS <sup>1</sup> (dB)				AMP. UNBAL. (dB)	PHASE UNBAL. (deg.)	ISOLATION (dB)			VSWR (:1)				
	S-1	S-2	S-3	S-4			1-2	2-3	3-4	S	1	2	3	4
4000	8.95	9.00	9.02	8.93	0.09	6.12	20.93	21.07	21.13	4.82	2.30	2.59	2.65	2.28
4200	8.71	8.75	8.74	8.68	0.07	5.92	21.94	21.85	22.12	3.99	2.22	2.43	2.48	2.19
4400	8.51	8.52	8.49	8.48	0.05	5.89	23.05	22.98	23.35	3.32	2.12	2.31	2.33	2.08
4500	8.30	8.30	8.33	8.26	0.06	5.29	23.76	23.58	24.06	3.03	2.08	2.24	2.25	2.02
4700	7.61	7.56	7.60	7.59	0.05	4.59	25.51	25.17	25.57	2.50	1.99	2.08	2.10	1.92
4800	7.65	7.59	7.64	7.62	0.05	4.58	26.54	25.82	26.50	2.29	1.94	2.02	2.04	1.88
4900	7.25	7.14	7.16	7.23	0.10	4.21	27.57	26.73	27.32	2.10	1.90	1.95	1.98	1.83
4950	7.48	7.38	7.41	7.45	0.10	4.32	28.04	27.17	27.82	2.02	1.87	1.93	1.95	1.83
5000	7.21	7.10	7.14	7.19	0.11	4.06	28.61	27.67	28.21	1.93	1.86	1.89	1.93	1.81
5050	7.14	7.03	7.06	7.12	0.12	3.96	29.20	28.16	28.80	1.86	1.84	1.88	1.91	1.79
5100	7.10	6.96	6.98	7.09	0.14	3.84	29.59	28.63	29.07	1.80	1.84	1.84	1.87	1.78
5150	7.15	7.03	7.08	7.13	0.11	3.84	30.00	29.04	29.36	1.73	1.82	1.81	1.85	1.76
5200	6.94	6.82	6.85	6.94	0.13	3.63	30.34	29.18	29.60	1.67	1.79	1.79	1.81	1.74
5250	6.94	6.80	6.84	6.93	0.14	3.49	30.45	29.60	29.98	1.61	1.77	1.74	1.78	1.72
5300	7.00	6.84	6.89	7.00	0.16	3.45	30.43	29.76	30.05	1.56	1.74	1.74	1.76	1.71
5350	6.86	6.73	6.76	6.86	0.13	3.19	30.64	29.66	30.08	1.51	1.73	1.70	1.72	1.67
5400	6.87	6.72	6.76	6.86	0.15	3.13	30.44	29.82	30.01	1.48	1.73	1.68	1.71	1.67
5450	6.85	6.70	6.73	6.84	0.15	3.00	30.43	29.31	29.96	1.44	1.72	1.67	1.68	1.65
5500	6.84	6.69	6.72	6.81	0.15	2.98	30.17	29.20	29.62	1.42	1.71	1.66	1.68	1.63
5550	6.79	6.64	6.66	6.77	0.15	2.79	29.73	29.25	29.47	1.39	1.70	1.64	1.65	1.63
5600	6.79	6.64	6.65	6.76	0.15	2.68	29.69	28.66	29.12	1.37	1.68	1.63	1.63	1.61
5650	6.80	6.63	6.66	6.78	0.17	2.67	29.40	28.22	28.79	1.36	1.65	1.62	1.62	1.60
5700	6.77	6.62	6.64	6.74	0.15	2.46	28.92	27.78	28.29	1.34	1.65	1.59	1.59	1.58
5750	6.78	6.62	6.64	6.76	0.16	2.30	28.71	27.16	27.76	1.33	1.62	1.58	1.57	1.56
5800	6.77	6.62	6.63	6.74	0.15	2.32	28.25	26.43	27.31	1.33	1.62	1.55	1.55	1.55
5850	6.76	6.60	6.60	6.73	0.16	2.09	28.05	25.91	27.03	1.35	1.61	1.54	1.51	1.54
5900	6.80	6.65	6.65	6.78	0.16	2.05	27.53	25.46	26.65	1.36	1.59	1.51	1.50	1.53
5950	6.74	6.59	6.59	6.71	0.15	2.12	27.28	24.83	26.00	1.37	1.59	1.49	1.48	1.51
6000	6.76	6.61	6.61	6.73	0.15	2.15	26.85	24.38	25.63	1.39	1.58	1.48	1.46	1.51
6050	6.82	6.66	6.66	6.79	0.16	2.08	26.41	23.90	25.24	1.41	1.57	1.45	1.45	1.50
6100	6.78	6.65	6.64	6.75	0.14	2.10	26.01	23.55	24.90	1.44	1.56	1.45	1.43	1.49
6150	6.81	6.67	6.66	6.78	0.14	2.12	25.37	23.09	24.58	1.46	1.55	1.42	1.42	1.49
6200	6.80	6.69	6.67	6.78	0.13	2.07	25.10	22.53	24.20	1.50	1.55	1.42	1.41	1.47
6250	6.92	6.79	6.77	6.88	0.15	2.23	24.60	22.13	23.85	1.54	1.55	1.41	1.39	1.47
6300	6.79	6.69	6.67	6.77	0.12	2.27	24.33	21.74	23.50	1.57	1.54	1.39	1.38	1.46
6350	6.89	6.79	6.76	6.87	0.13	2.22	23.77	21.37	23.12	1.61	1.54	1.40	1.37	1.45
6400	6.96	6.84	6.82	6.93	0.14	2.25	23.50	21.01	22.83	1.66	1.53	1.37	1.36	1.45
6450	6.91	6.83	6.82	6.89	0.09	2.32	23.02	20.57	22.66	1.69	1.53	1.37	1.35	1.45
6500	6.87	6.81	6.76	6.85	0.11	2.36	22.68	20.39	22.31	1.75	1.53	1.37	1.34	1.45
6550	7.04	6.95	6.93	7.00	0.12	2.44	22.39	20.06	21.87	1.79	1.52	1.36	1.34	1.45
6600	7.03	6.96	6.93	7.00	0.10	2.47	22.10	19.75	21.80	1.84	1.52	1.35	1.33	1.45
6650	6.86	6.86	6.83	6.84	0.03	2.62	21.82	19.48	21.55	1.88	1.51	1.34	1.33	1.45
6700	7.17	7.11	7.06	7.14	0.10	2.65	21.58	19.18	21.36	1.93	1.51	1.34	1.32	1.45
6800	7.08	7.09	7.06	7.05	0.03	2.77	21.15	18.72	20.91	2.02	1.50	1.32	1.31	1.45
6900	7.30	7.28	7.25	7.27	0.05	2.95	20.81	18.28	20.55	2.11	1.51	1.31	1.29	1.44
7000	7.16	7.24	7.20	7.15	0.10	3.59	20.43	17.82	20.19	2.18	1.49	1.29	1.27	1.44
7200	7.19	7.37	7.32	7.18	0.19	4.32	19.74	17.18	19.48	2.32	1.46	1.26	1.25	1.42
7400	7.57	7.62	7.60	7.55	0.08	4.49	19.30	16.25	19.00	2.45	1.43	1.25	1.23	1.40
7600	7.49	7.58	7.60	7.49	0.11	4.19	18.86	15.53	18.60	2.52	1.38	1.22	1.21	1.37
7800	7.35	7.54	7.56	7.35	0.21	4.35	18.34	15.02	18.21	2.57	1.35	1.22	1.21	1.36
8000	7.33	7.51	7.55	7.33	0.21	4.50	17.90	14.44	17.74	2.61	1.31	1.23	1.22	1.35
8200	7.61	7.75	7.74	7.62	0.15	6.23	17.29	14.06	17.44	2.63	1.30	1.24	1.23	1.33
8400	7.73	7.72	7.74	7.70	0.04	6.59	16.72	13.56	17.08	2.68	1.28	1.24	1.25	1.32
8500	7.61	7.61	7.63	7.58	0.05	6.05	16.43	13.46	16.98	2.73	1.28	1.26	1.28	1.32

<sup>1</sup> Total Loss = Insertion Loss+ 6dB Splitter Loss

REV. X2  
WP4A+  
100627

Page 2 of 3



RF/MICROWAVE COMPONENTS • ISO 9001 ISO 14001 AS 9100 CERTIFIED • RoHS compliant  
P.O. Box 350166, Brooklyn, New York 11235-0006 (718) 934-4500 Fax (718) 332-4661



The Design Engineers Search Engine finds the model you need, Instantly • For detailed performance specs & shopping online see



# 4 Way-0° Power Splitter/Combiner

# WP4A+

## Typical Performance Data

TEST CONDITIONS: INPUT POWER = -10dBm @Temperature = +85°C

FREQ. (MHz)	TOTAL LOSS <sup>1</sup> (dB)				AMP. UNBAL. (dB)	PHASE UNBAL. (deg.)	ISOLATION (dB)			VSWR (:1)				
	S-1	S-2	S-3	S-4			1-2	2-3	3-4	S	1	2	3	4
4000	8.95	8.97	8.95	8.93	0.05	6.26	21.56	21.68	21.72	4.38	2.29	2.55	2.61	2.25
4200	8.86	8.88	8.85	8.84	0.04	5.74	22.63	22.58	22.77	3.68	2.20	2.39	2.45	2.15
4400	8.91	8.92	8.89	8.88	0.04	5.39	23.88	23.74	24.09	3.08	2.10	2.26	2.29	2.04
4500	8.45	8.43	8.46	8.43	0.02	4.84	24.67	24.41	24.85	2.81	2.04	2.19	2.22	1.98
4700	7.78	7.70	7.70	7.77	0.08	4.32	26.48	26.01	26.44	2.34	1.95	2.03	2.07	1.88
4800	7.83	7.75	7.76	7.82	0.08	4.14	27.42	26.63	27.36	2.13	1.90	1.96	2.00	1.83
4900	7.59	7.47	7.43	7.57	0.15	4.01	28.39	27.53	28.20	1.95	1.85	1.89	1.93	1.78
4950	7.79	7.68	7.68	7.77	0.12	3.95	28.85	27.88	28.74	1.87	1.83	1.88	1.90	1.77
5000	7.50	7.37	7.36	7.48	0.14	3.74	29.18	28.38	29.23	1.79	1.81	1.84	1.86	1.74
5050	7.43	7.30	7.28	7.40	0.15	3.68	29.61	28.85	29.65	1.72	1.78	1.81	1.84	1.72
5100	7.52	7.37	7.33	7.48	0.19	3.63	29.95	29.14	29.86	1.65	1.77	1.79	1.80	1.70
5150	7.38	7.25	7.25	7.36	0.13	3.57	30.17	29.47	30.20	1.58	1.75	1.75	1.78	1.68
5200	7.31	7.14	7.11	7.27	0.20	3.36	30.33	29.64	30.37	1.53	1.72	1.74	1.74	1.66
5250	7.29	7.12	7.09	7.26	0.20	3.22	30.36	29.65	30.73	1.47	1.71	1.69	1.72	1.64
5300	7.33	7.16	7.13	7.29	0.20	3.19	30.37	29.80	30.65	1.42	1.69	1.68	1.70	1.63
5350	7.16	7.00	6.96	7.13	0.19	3.01	30.33	29.54	30.54	1.38	1.67	1.65	1.66	1.60
5400	7.18	7.01	6.97	7.14	0.21	2.90	30.24	29.71	30.45	1.35	1.66	1.62	1.64	1.59
5450	7.19	7.00	6.97	7.14	0.22	2.78	30.15	28.95	30.37	1.32	1.65	1.61	1.62	1.58
5500	7.09	6.92	6.89	7.06	0.20	2.73	29.87	28.61	30.02	1.30	1.63	1.58	1.60	1.55
5550	7.10	6.91	6.87	7.05	0.23	2.53	29.56	28.40	29.77	1.29	1.63	1.56	1.59	1.55
5600	7.08	6.89	6.86	7.03	0.22	2.38	29.30	27.65	29.35	1.28	1.61	1.53	1.56	1.53
5650	7.08	6.89	6.86	7.03	0.22	2.37	29.18	27.35	28.96	1.29	1.60	1.53	1.55	1.52
5700	7.04	6.86	6.82	7.01	0.22	2.22	28.63	26.98	28.52	1.30	1.59	1.49	1.53	1.51
5750	7.06	6.86	6.83	7.00	0.23	2.08	28.58	26.34	27.96	1.32	1.58	1.49	1.52	1.49
5800	7.05	6.86	6.81	6.99	0.23	1.90	28.11	25.70	27.65	1.33	1.57	1.47	1.51	1.49
5850	7.03	6.84	6.80	6.97	0.22	1.72	27.80	25.17	27.37	1.36	1.57	1.46	1.48	1.48
5900	7.06	6.87	6.85	7.00	0.22	1.66	27.29	24.74	26.91	1.38	1.55	1.44	1.48	1.47
5950	7.01	6.83	6.80	6.96	0.21	1.46	26.95	24.22	26.33	1.41	1.54	1.41	1.46	1.46
6000	7.03	6.86	6.82	6.98	0.21	1.32	26.36	23.84	25.94	1.45	1.54	1.41	1.44	1.46
6050	7.10	6.92	6.88	7.04	0.22	1.26	26.03	23.40	25.63	1.48	1.53	1.39	1.43	1.44
6100	7.02	6.86	6.84	6.95	0.18	1.11	25.61	23.06	25.20	1.51	1.52	1.39	1.42	1.43
6150	7.09	6.93	6.89	7.03	0.20	0.96	25.24	22.67	24.93	1.54	1.51	1.36	1.41	1.44
6200	7.10	6.94	6.90	7.03	0.20	0.86	24.92	22.24	24.57	1.58	1.50	1.35	1.40	1.43
6250	7.17	7.01	6.99	7.10	0.18	0.78	24.58	22.04	24.22	1.61	1.50	1.35	1.39	1.43
6300	7.09	6.95	6.91	7.02	0.17	0.83	24.26	21.69	23.93	1.64	1.49	1.32	1.38	1.42
6350	7.19	7.06	7.02	7.12	0.17	0.76	23.92	21.43	23.46	1.67	1.49	1.33	1.37	1.42
6400	7.29	7.14	7.11	7.22	0.18	0.71	23.67	21.05	23.20	1.71	1.48	1.31	1.36	1.42
6450	7.15	7.06	7.04	7.08	0.10	0.89	23.29	20.83	23.03	1.73	1.47	1.30	1.35	1.42
6500	7.28	7.16	7.12	7.21	0.17	1.20	23.04	20.65	22.69	1.77	1.47	1.30	1.34	1.42
6550	7.35	7.24	7.21	7.28	0.14	1.10	22.88	20.39	22.29	1.79	1.46	1.28	1.34	1.42
6600	7.32	7.24	7.22	7.25	0.10	1.17	22.60	20.19	22.12	1.82	1.45	1.28	1.33	1.42
6650	7.26	7.21	7.16	7.20	0.10	1.68	22.48	19.91	21.93	1.85	1.44	1.27	1.32	1.42
6700	7.53	7.42	7.40	7.44	0.13	1.34	22.26	19.68	21.70	1.87	1.44	1.27	1.32	1.42
6800	7.40	7.38	7.37	7.33	0.06	1.65	21.94	19.26	21.26	1.92	1.42	1.25	1.30	1.42
6900	7.59	7.55	7.54	7.53	0.06	1.62	21.60	18.87	20.80	1.96	1.41	1.23	1.28	1.42
7000	7.56	7.58	7.54	7.50	0.08	2.18	21.25	18.51	20.49	2.00	1.39	1.22	1.27	1.42
7200	7.70	7.78	7.72	7.65	0.13	2.80	20.51	17.75	19.77	2.07	1.38	1.22	1.26	1.42
7400	7.93	7.93	7.91	7.87	0.06	2.46	19.94	16.82	19.24	2.15	1.37	1.21	1.24	1.43
7600	7.75	7.84	7.83	7.73	0.11	2.64	19.23	16.13	18.78	2.21	1.38	1.21	1.24	1.42
7800	7.67	7.89	7.82	7.67	0.22	3.23	18.52	15.53	18.38	2.30	1.38	1.23	1.25	1.42
8000	7.65	7.88	7.75	7.65	0.23	3.75	17.86	14.91	17.93	2.41	1.39	1.26	1.27	1.41
8200	8.14	8.12	8.03	8.09	0.11	5.21	17.25	14.51	17.66	2.50	1.40	1.28	1.30	1.39
8400	8.17	8.01	7.97	8.11	0.21	5.22	16.80	14.02	17.36	2.63	1.41	1.32	1.33	1.37
8500	7.94	7.95	7.83	7.90	0.12	4.83	16.73	13.84	17.21	2.68	1.41	1.33	1.35	1.36

<sup>1</sup> Total Loss = Insertion Loss+ 6dB Splitter Loss

REV. X2  
WP4A+  
100627

Page 3 of 3



RF/MICROWAVE COMPONENTS • ISO 9001 ISO 14001 AS 9100 CERTIFIED • RoHS compliant  
P.O. Box 350166, Brooklyn, New York 11235-0006 (718) 934-4500 Fax (718) 332-4661



The Design Engineers Search Engine finds the model you need, Instantly • For detailed performance specs & shopping online see



## Typical Performance Curves

**Total Loss**

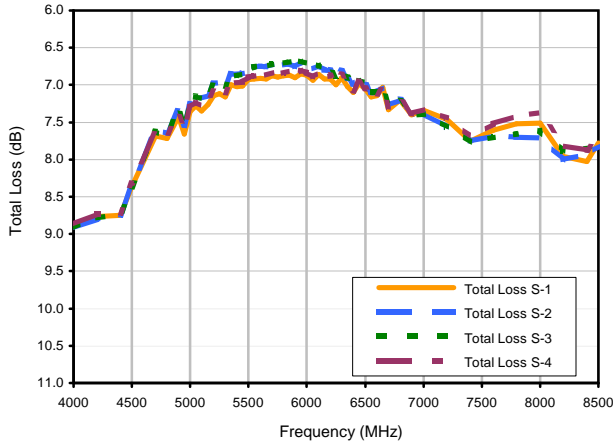

**Total Loss S-1 vs. TEMPERATURE**

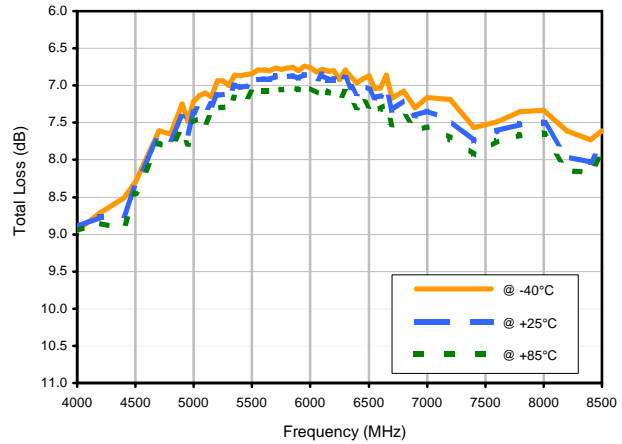

**Amplitude Unbalance vs. TEMPERATURE**

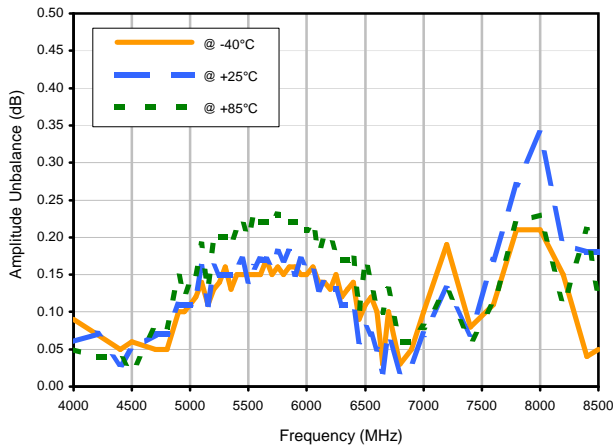

**Phase Unbalance vs. TEMPERATURE**

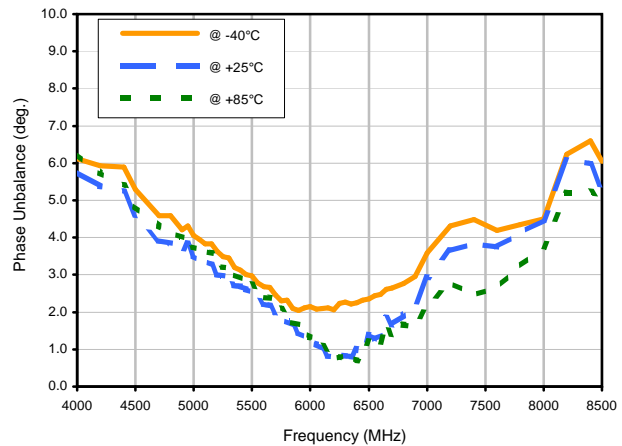

**Isolation**

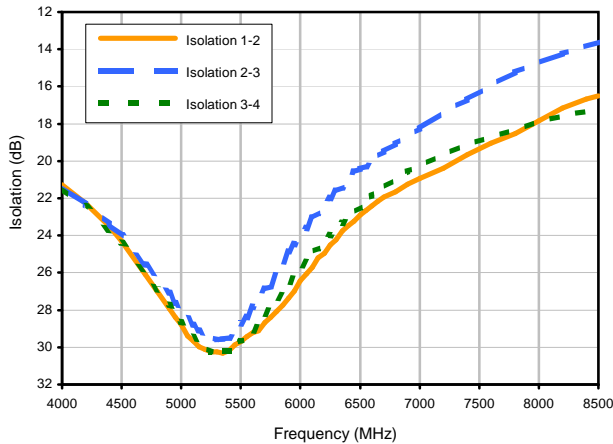

**Isolation 1-2 vs. TEMPERATURE**

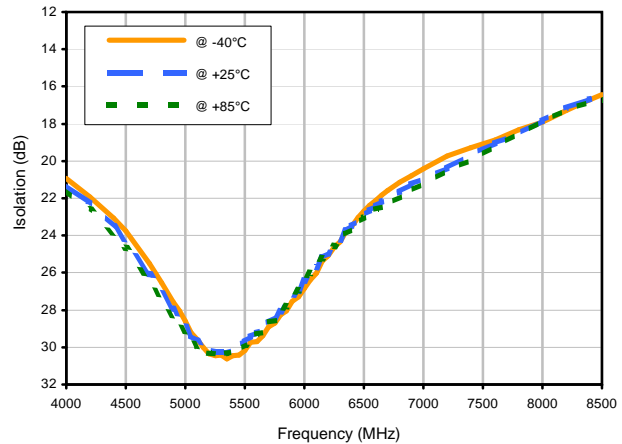

## Typical Performance Curves

VSWR

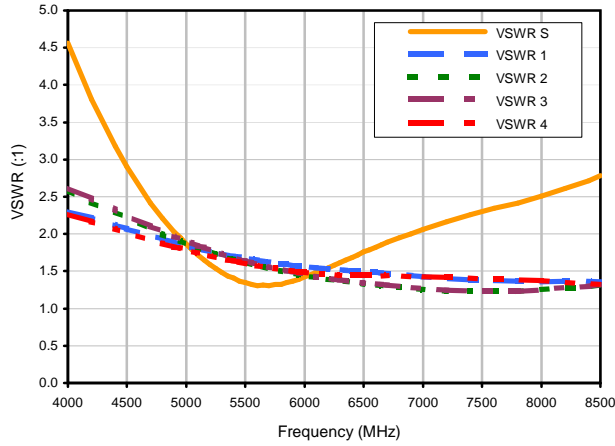

VSWR SUM vs. TEMPERATURE

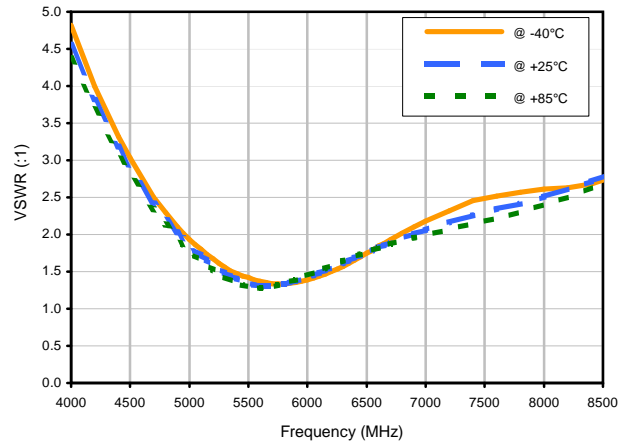

VSWR OUT1 vs. TEMPERATURE

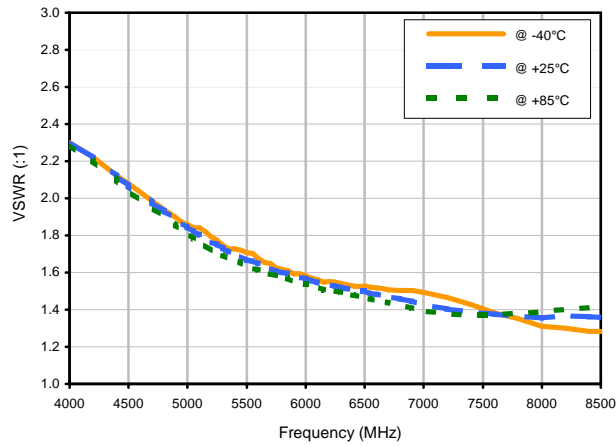



### Outline Dimensions



### PCB Land Pattern

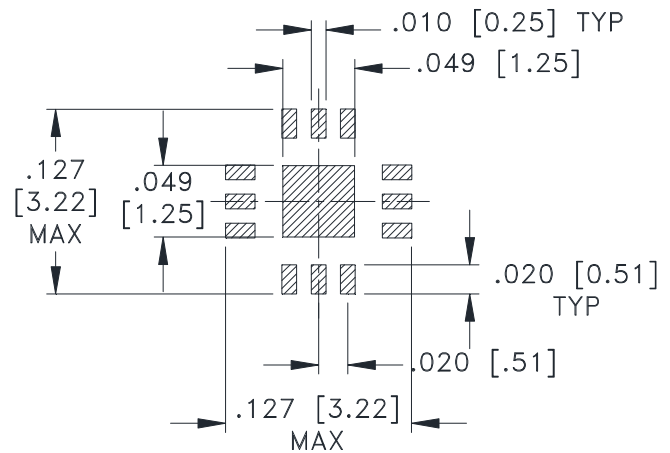

SUGGESTED LAYOUT,  
TOLERANCE TO BE WITHIN  $\pm .002$

**Weight: .02 Grams**

**Dimensions are in inches (mm). Tolerances: 2Pl.  $\pm .01$ ; 3 Pl.  $\pm .004$**

### Notes:

1. Case material: Plastic.
2. Termination finish:
  - For RoHS Case Styles: Tin-Silver alloy plate over Nickel barrier or Matte-Tin. All models, (+) suffix. See Data sheet.
  - For RoHS-5 Case Styles: Tin-Lead plate. All models, no (+) suffix.

**Mini-Circuits®**

Distribution Centers NORTH AMERICA 800-654-7949 • 417-335-5935 • Fax 417-335-5945 • EUROPE 44-1252-832600 • Fax 44-1252-837010

Mini-Circuits ISO 9001 & ISO 14001 Certified

INTERNET <http://www.minicircuits.com>

P.O. Box 350166, Brooklyn, New York 11235-0003 (718) 934-4500 Fax (718) 332-4661

# Tape & Reel Packaging TR-F66



Tape Width, mm	Device Cavity Pitch, mm	Reel Size, inches	Devices per Reel see note	
8	4	7	Small quantity standard	20
				50
				100
				200
				500
		7	Standard	1000, 2000, 3000

Note: Please consult individual model data sheet to determine device per reel availability.

Mini-Circuits carrier tape materials provide protection from ESD (Electro-Static Discharge) during handling and transportation. Tapes are static dissipative and comply with industry standards EIA-481/EIA-541.

Go to: [www.minicircuits.com/pages/pdfs/tape.pdf](http://www.minicircuits.com/pages/pdfs/tape.pdf)

**Mini-Circuits®**

INTERNET <http://www.minicircuits.com>

P.O. Box 350166, Brooklyn, New York 11235-0003 (718) 934-4500 Fax (718) 332-4661

Distribution Centers NORTH AMERICA 800-654-7949 • 417-335-5935 • Fax 417-335-5945 • EUROPE 44-1252-832600 • Fax 44-1252-837010

Mini-Circuits ISO 9001 & ISO 14001 Certified

THIRD ANGLE PROJECTION

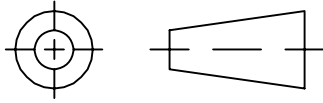

REVISIONS

REV	ECN No.	DESCRIPTION	DATE	DR	AUTH
OR	M109251	NEW RELEASE	01/11/07	PW	WP
A	M112849	UPDATED NOTE 3	08/03/07	AV	WP

**SUGGESTED MOUNTING CONFIGURATION FOR  
DQ1225 CASE STYLE, "rx" PIN CONNECTION**

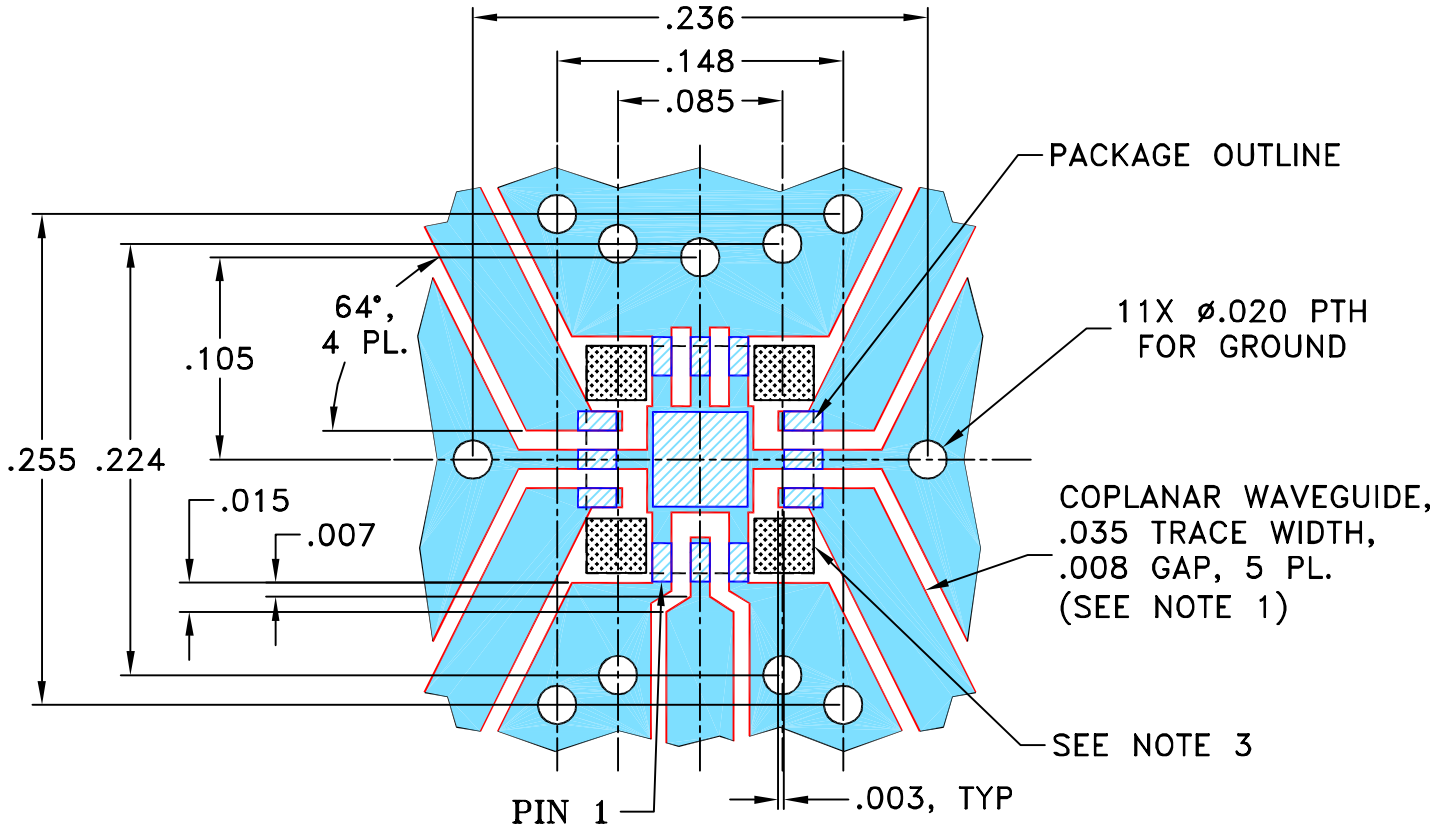

**NOTES:**

1. TRACE WIDTH IS SHOWN FOR ROGERS R04350B WITH DIELECTRIC THICKNESS .020" ± .0015"; COPPER: 1/2 OZ. EACH SIDE. FOR OTHER MATERIALS TRACE WIDTH AND GAP MAY NEED TO BE MODIFIED.
2. BOTTOM SIDE OF THE PCB IS CONTINUOUS GROUND PLANE.
3. SIGNAL TRACES ARE NOT ALLOWED INSIDE HATCHED AREAS (APPROX. .030 X .030) AT 4 PLACES AS SHOWN.



DENOTES PCB COPPER LAYOUT WITH SMOBC (SOLDER MASK OVER BARE COPPER)



DENOTES COPPER LAND PATTERN FREE OF SOLDER MASK

UNLESS OTHERWISE SPECIFIED

INITIALS

DATE

DIMENSIONS ARE IN INCHES

DRAWN

PW

01/10/07

TOLERANCES ON:

CHECKED

IL

01/11/07

2 PL DECIMALS ± .005

APPROVED

WP

01/11/07

3 PL DECIMALS ± .005

ANGLES ± 1°

FRACTIONS ±



**Mini-Circuits®**

13 Neptune Avenue  
Brooklyn NY 11235

PL, rx, DQ1225, WP4, TB-395+

THIS DOCUMENT AND ITS CONTENTS ARE THE PROPERTY OF MINI-CIRCUITS. EXCEPT FOR USE EXPRESSLY GRANTED, IN WRITING, TO ITS VENDORS, VENDEE AND THE UNITED STATES GOVERNMENT, MINI-CIRCUITS RESERVES ALL PROPRIETARY DESIGN, USE, MANUFACTURING AND REPRODUCTION RIGHTS THERETO. THESE CONTENTS SHALL NOT BE USED, DUPLICATED OR DISCLOSED TO ANY OUTSIDE PARTY, IN WHOLE OR IN PART, WITHOUT WRITTEN PERMISSION OF MINI-CIRCUITS.

SIZE  
A

CODE IDENT  
15542

DRAWING NO:  
98-PL-259

REV:  
A

FILE: 98PL259

SCALE: 10:1

SHEET: 1 OF 1

ASHEETA1.DWG REV:A DATE:01/12/95

# Evaluation Board and Circuit

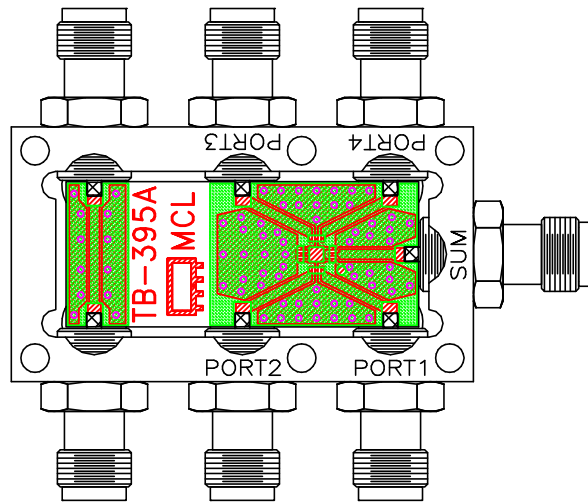

TB-395+

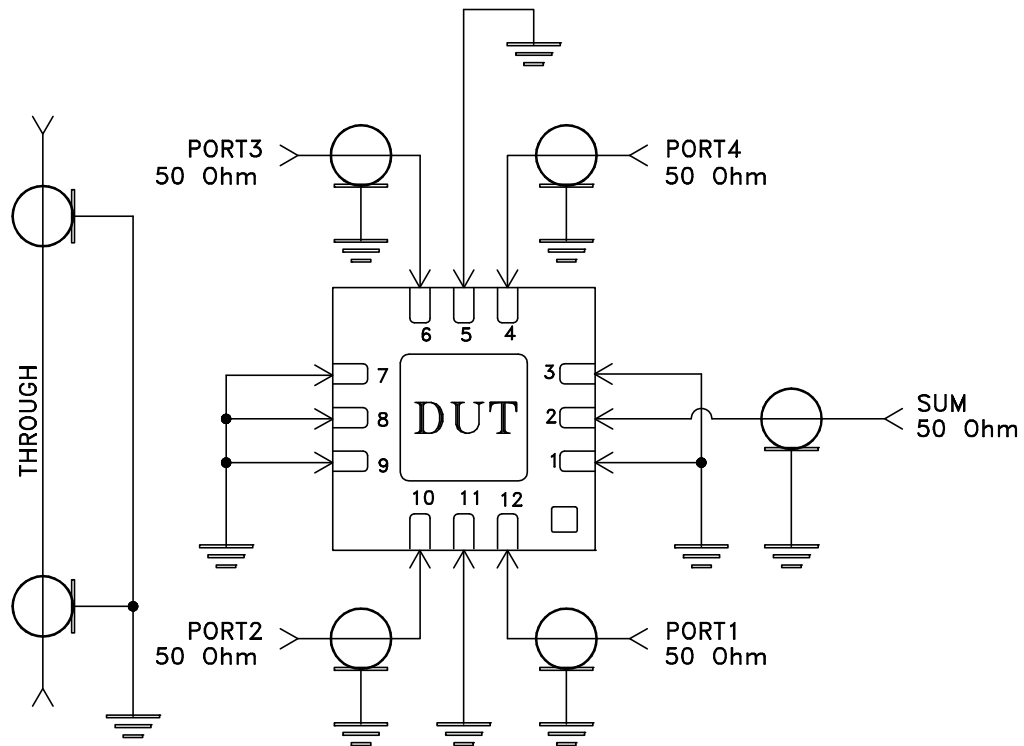

Schematic Diagram

## Notes:

1. SMA Female connectors.
2. PCB Material: Rogers R04350 or equivalent,  
Dielectric Constant=3.5, Thickness=.020 inch.

 **Mini-Circuits®**

All Mini-Circuits products are manufactured under exacting quality assurance and control standards, and are capable of meeting published specifications after being subjected to any or all of the following physical and environmental test.

Specification	Test/Inspection Condition	Reference/Spec
Operating Temperature	-40° to 85° C Ambient Environment	Individual Model Data Sheet
Storage Temperature	-65° to 150° C Ambient Environment	Individual Model Data Sheet
Autoclave	15 psig, 100% RH, 121°C, 96 hours	JESD22-A102-C, Condition C
Temperature Cycling	-65° to 150°C, 100 cycles	JESD22-A104
Temperature Humidity	85°C/ 85% RH, 168 hours	JESD22-113
Solder Reflow Heat	Sn-Pb Eutetic Process: 240°C peak Pb-Free Process: 260°C peak	J-STD-020, Table 4-1, 4-2 and 5-2; Figure 5-1
Moisture Sensitivity: Level 1	Bake at 125°C for 24 hours Soak at 85°C/85% RH for 168 hours, Reflow 3 cycles at 240°C peak (Non-RoHS) or 260°C (RoHS)	J-STD-020
Solderability	10X magnification, 95% coverage	JESD22-B102, Method 1: Dip and Look Test
Mechanical Shock	50g, 11 ms, 1/2-sine, 18 shocks: 3 each direction, each of 3 axes	MIL-STD-202, Method 213, Condition A
Vibration (High Frequency)	20g peak, 10-2000 Hz, 12 times in each of three perpendicular directions (total 36)	MIL-STD-202, Method 204, Condition D