

925075-7 ✓ ACTIVE

MATE-N-LOK | Commercial MATE-N-LOK

TE Internal #: 925075-7

Housing, Plug, Wire-to-Wire, 4 Position, 5.08 mm [.2 in] Centerline,
Wire & Cable, UL 94V-0, Commercial MATE-N-LOK, Rectangular
Power Connectors

[View on TE.com >](#)



Connectors > Power Connectors > Rectangular Power > Rectangular Power Connectors



Rectangular Power Connector Type: **Housing**

Connector & Housing Type: **Plug**

Connector System: **Wire-to-Wire**

Number of Positions: **4**

Centerline (Pitch): **5.08 mm [.2 in]**

Features

Product Type Features

Rectangular Power Connector Type	Housing
Connector & Housing Type	Plug
Connector System	Wire-to-Wire
Sealable	No
Connector & Contact Terminates To	Wire & Cable

Configuration Features

Number of Positions	4
Number of Rows	2

Electrical Characteristics

Operating Voltage	250 VAC
-------------------	---------

Contact Features

Multiple Contact Types	Without
Contact Retention Within Housing	Without
Contact Type	Pin

Termination Features

Termination Method to Wire & Cable	Crimp
------------------------------------	-------

Mechanical Attachment

Connector Mounting Type	Panel Mount
-------------------------	-------------

Housing Features

Centerline (Pitch)	5.08 mm [.2 in]
--------------------	-----------------

Housing Color	Natural
---------------	---------

Housing Material	PA 66
------------------	-------

Dimensions

Row-to-Row Spacing	5.08 mm [.2 in]
--------------------	-----------------

Usage Conditions

Operating Temperature Range	-55 – 105 °C [-67 – 221 °F]
-----------------------------	-----------------------------

Operation/Application

Circuit Application	Power & Signal
---------------------	----------------

Identification Marking

Circuit Identification Feature	Without
--------------------------------	---------

Industry Standards

Compatible With Agency/Standards Products	VDE
---	-----

Compatible With Approved Standards Products	VDE 40043021
---	--------------

UL Flammability Rating	UL 94V-0
------------------------	----------

Glow Wire Rating	GWT 750°C (Without Flame)
------------------	---------------------------

Packaging Features

Packaging Quantity	500
--------------------	-----

Packaging Method	Box
------------------	-----

Product Compliance

[For compliance documentation, visit the product page on TE.com>](#)

EU RoHS Directive 2011/65/EU	Compliant
------------------------------	-----------

EU ELV Directive 2000/53/EC	Compliant
-----------------------------	-----------

China RoHS 2 Directive MIIT Order No 32, 2016	No Restricted Materials Above Threshold
---	---

EU REACH Regulation (EC) No. 1907/2006	
--	--



Current ECHA Candidate List: JUNE 2024 (241)
 Candidate List Declared Against: JUNE 2024 (241)
 Does not contain REACH SVHC

Halogen Content	Not Low Halogen - contains Br or Cl > 900 ppm.
-----------------	--

Solder Process Capability	Not reviewed for solder process capability
---------------------------	--

Product Compliance Disclaimer

This information is provided based on reasonable inquiry of our suppliers and represents our current actual knowledge based on the information they provided. This information is subject to change. The part numbers that TE has identified as EU RoHS compliant have a maximum concentration of 0.1% by weight in homogenous materials for lead, hexavalent chromium, mercury, PBB, PBDE, DBP, BBP, DEHP, DIBP, and 0.01% for cadmium, or qualify for an exemption to these limits as defined in the Annexes of Directive 2011/65/EU (RoHS2). Finished electrical and electronic equipment products will be CE marked as required by Directive 2011/65/EU. Components may not be CE marked. Additionally, the part numbers that TE has identified as EU ELV compliant have a maximum concentration of 0.1% by weight in homogenous materials for lead, hexavalent chromium, and mercury, and 0.01% for cadmium, or qualify for an exemption to these limits as defined in the Annexes of Directive 2000/53/EC (ELV). Regarding the REACH Regulation, the information TE provides on SVHC in articles for this part number is based on the latest European Chemicals Agency (ECHA) 'Guidance on requirements for substances in articles' posted at this URL: <https://echa.europa.eu/guidance-documents/guidance-on-reach>

Compatible Parts



TE Part # 925076-3
 4W CIRCULAR MATE-N-LOK SOCKET HSG BLK



TE Part # 1-480425-0
 04P CMNL PLUG HSG P/M NATL



TE Part # 794048-1
 08P CMNL CAP HSG D/L



TE Part # 925075-6
 4W CIRCULAR MATE-N-LOK PIN HSG NAT



TE Part # 1-480728-0
 04P CMNL CAP HSG P/M D/L NATL



TE Part # 925076-7
 4W CIRCULAR MATE-N-LOK SOCKET HSG NAT



TE Part # 925075
 4W CIRCULAR MATE-N-LOK PIN HSG NAT



TE Part # 925076-6
 4W CIRCULAR MATE-N-LOK SOCKET HSG NAT



TE Part # 1-480727-0
04P CMNL PLUG HSG P/M D/L NATL



TE Part # 342376-1
4W CIRC MNL LATCHED HSG. NATUR

Also in the Series | Commercial MATE-N-LOK

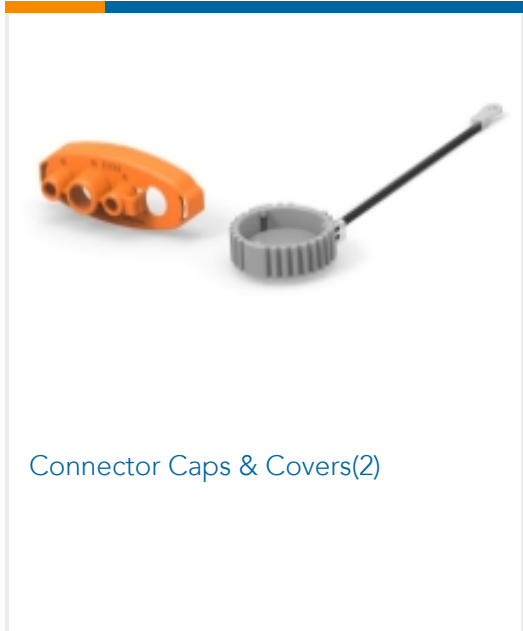

Connector Caps & Covers(2)

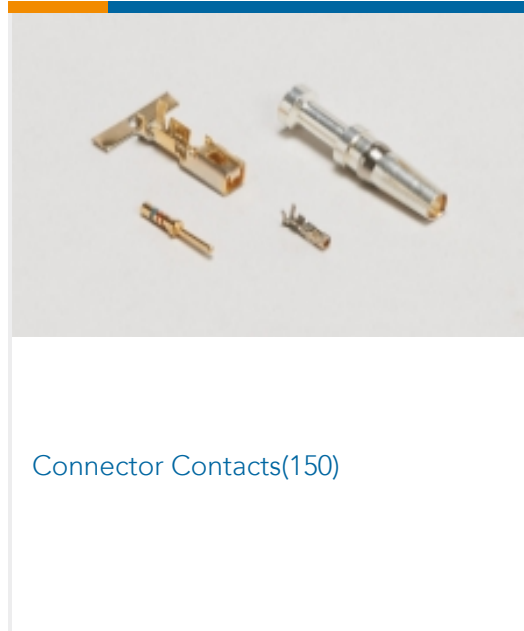

Connector Contacts(150)

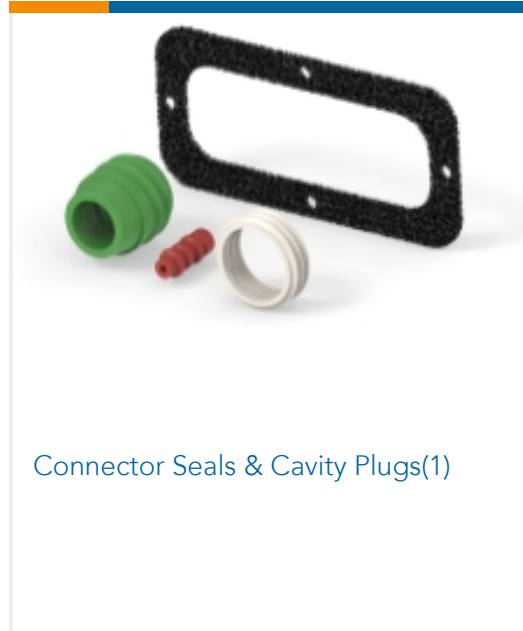

Connector Seals & Cavity Plugs(1)



Crimp Wire Pins, Tabs & Ferrules(2)

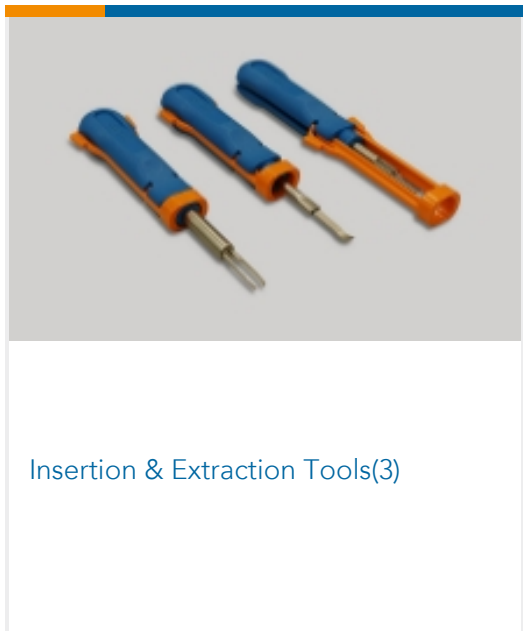

Insertion & Extraction Tools(3)

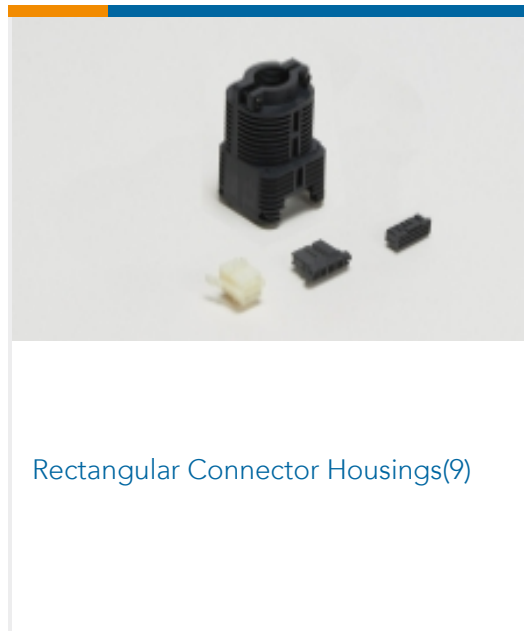

Rectangular Connector Housings(9)

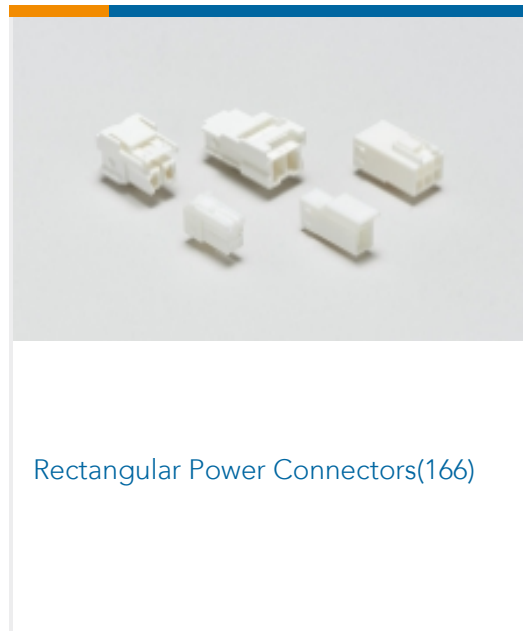

Rectangular Power Connectors(166)

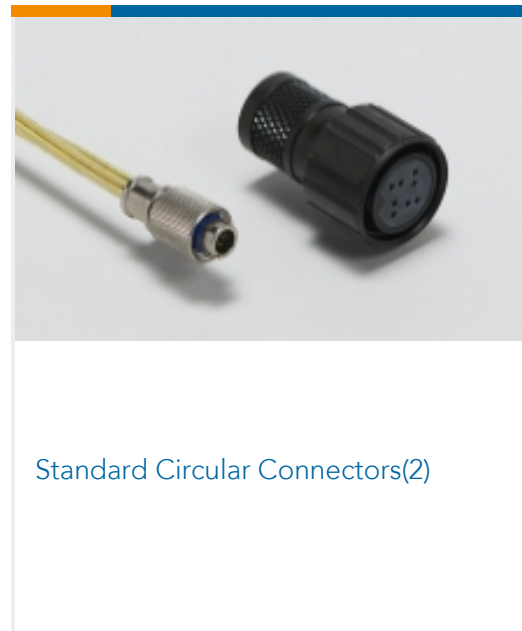

Standard Circular Connectors(2)

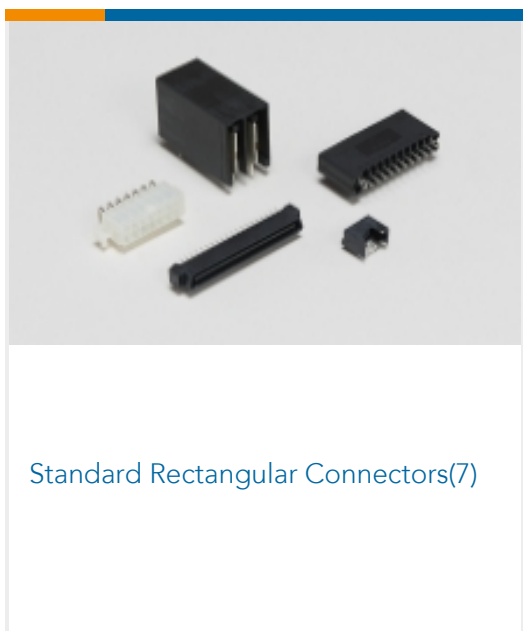

Standard Rectangular Connectors(7)

Customers Also Bought



TE Part #165514-1
TERM, WIRE PIN, PIDG, 26-22

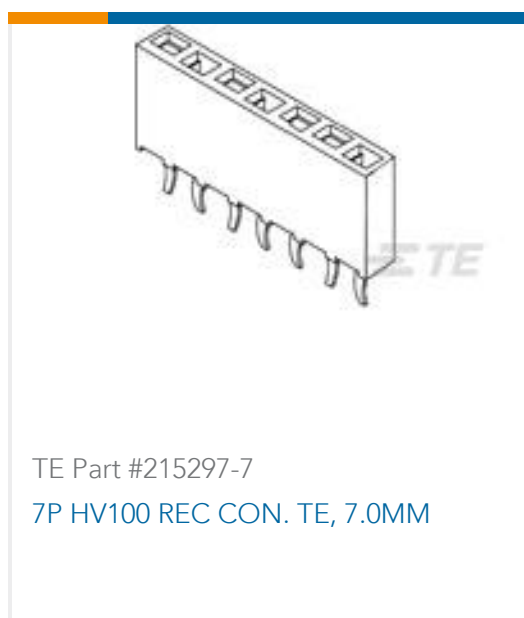

TE Part #215297-7
7P HV100 REC CON. TE, 7.0MM



TE Part #641776-1
04P UMNL STR/REL



TE Part #350766-4
03P UMNL PLUG HSG UL94V0



Documents

Product Drawings

4W CIRCULAR MATE-N-LOK PIN HSG NAT

English

CAD Files

3D PDF

3D

Customer View Model

[ENG_CVM_CVM_925075-7_A.2d_dxf.zip](#)

English

Customer View Model

[ENG_CVM_CVM_925075-7_A.3d_igs.zip](#)

English

Customer View Model

[ENG_CVM_CVM_925075-7_A.3d_stp.zip](#)

English

By downloading the CAD file I accept and agree to the [Terms and Conditions](#) of use.

Product Specifications

Application Specification

English

Agency Approvals

VDE Certificate

English

VDE Certificate

English

925075-7

Housing, Plug, Wire-to-Wire, 4 Position, 5.08 mm [.2 in] Centerline, Wire & Cable, UL 94V-0, Commercial MATE-N-LOK, Rectangular Power Connectors

