

OSRAM LS E67F.01

Datasheet

Published by **ams-OSRAM AG**

Tobelbader Strasse 30, 8141 Premstaetten, Austria

Phone +43 3136 500-0

ams-osram.com

© All rights reserved



Power TOPLED®

LS E67F.01 - Dual Binning

PowerTOPLED, a powerful member of the TOPLED family. Thanks to their high luminous efficacy, the LEDs are ideal for rear light clusters and indicators on vehicles and for display panels for traffic control systems.



Applications

- Functional Illumination
- Static Signaling

Features

- Package: white PLCC-4 package, colorless clear resin
- Chip technology: Thinfilm
- Typ. Radiation: 120° (Lambertian emitter)
- Color: $\lambda_{\text{dom}} = 633 \text{ nm}$ (● super red)
- Corrosion Robustness Class: 3B
- Qualifications: AEC-Q102 Qualified with RV-level 1
- ESD: 2 kV acc. to ANSI/ESDA/JEDEC JS-001 (HBM, Class 2)

Ordering Information

Type	Luminous Intensity ¹⁾ $I_F = 4 \text{ mA}$ I_v	Luminous Intensity ¹⁾ $I_F = 50 \text{ mA}$ I_v	Ordering Code
LS E67F.01-R1S2-1-3X5X+8A6C-68-G3R3	112 ... 280 mcd	1590 ... 3550 mcd	Q65113A5552

Maximum Ratings

Parameter	Symbol		Values
Operating Temperature	T_{op}	min.	-40 °C
		max.	100 °C
Storage Temperature	T_{stg}	min.	-40 °C
		max.	100 °C
Junction Temperature	T_j	max.	125 °C
Forward current $T_s = 25\text{ °C}$	I_F	min.	3 mA
		max.	70 mA
Forward current pulsed $D = 0.005$; $T_s = 25\text{ °C}$	$I_{F\ pulse}$	max.	100 mA
Reverse voltage ²⁾ $T_s = 25\text{ °C}$	V_R	max.	12 V
ESD withstand voltage acc. to ANSI/ESDA/JEDEC JS-001 (HBM, Class 2)	V_{ESD}		2 kV

Characteristics

$I_F = 50 \text{ mA}$; $T_S = 25 \text{ °C}$

Parameter	Symbol		Values
Peak Wavelength	λ_{peak}	typ.	645 nm
Dominant Wavelength ³⁾ $I_F = 50 \text{ mA}$	λ_{dom}	min.	627 nm
		typ.	633 nm
		max.	637 nm
Spectral Bandwidth at 50% $I_{\text{rel,max}}$	$\Delta\lambda$	typ.	16 nm
Viewing angle at 50% I_V	2ϕ	typ.	120 °
Forward Voltage ⁴⁾ $I_F = 50 \text{ mA}$	V_F	min.	1.90 V
		typ.	2.15 V
		max.	2.50 V
Reverse current ²⁾ $V_R = 12 \text{ V}$	I_R	typ.	0.01 μA
		max.	10 μA
Temperature Coefficient of Peak Wavelength $-10\text{°C} \leq T \leq 100\text{°C}$	$TC_{\lambda\text{peak}}$	typ.	0.12 nm / K
Real thermal resistance junction/solderpoint ⁴⁾	$R_{\text{thJS real}}$	typ.	90 K / W
		max.	130 K / W
Electrical thermal resistance junction/solderpoint ⁵⁾ with efficiency $\eta_e = 51 \text{ %}$	$R_{\text{thJS elec.}}$	typ.	44 K / W
		max.	64 K / W

Brightness Groups

Group	Luminous Intensity ¹⁾ $I_F = 4 \text{ mA}$ min. I_v	Luminous Intensity. ¹⁾ $I_F = 4 \text{ mA}$ max. I_v	Luminous Flux ⁶⁾ $I_F = 4 \text{ mA}$ typ. Φ_v
R1	112 mcd	140 mcd	378 mlm
R2	140 mcd	180 mcd	480 mlm
S1	180 mcd	224 mcd	606 mlm
S2	224 mcd	280 mcd	756 mlm

Brightness Groups

Group	Luminous Intensity ¹⁾ $I_F = 50 \text{ mA}$ min. I_v	Luminous Intensity. ¹⁾ $I_F = 50 \text{ mA}$ max. I_v	Luminous Flux ⁶⁾ $I_F = 50 \text{ mA}$ typ. Φ_v
8A	1590 mcd	1800 mcd	5085 mlm
5B	1800 mcd	2010 mcd	5715 mlm
6B	2010 mcd	2240 mcd	6375 mlm
7B	2240 mcd	2500 mcd	7110 mlm
8B	2500 mcd	2800 mcd	7950 mlm
5C	2800 mcd	3150 mcd	8925 mlm
6C	3150 mcd	3550 mcd	10050 mlm

Forward Voltage Groups

Group	Forward Voltage ⁴⁾ $I_F = 4 \text{ mA}$ min. V_F	Forward Voltage ⁴⁾ $I_F = 4 \text{ mA}$ max. V_F
3X	1.65 V	1.71 V
3Y	1.71 V	1.77 V
4X	1.77 V	1.83 V
4Y	1.83 V	1.89 V
5X	1.89 V	1.95 V

Forward Voltage Groups

Group	Forward Voltage ⁴⁾ $I_F = 50 \text{ mA}$ min. V_F	Forward Voltage ⁴⁾ $I_F = 50 \text{ mA}$ max. V_F
G3	1.90 V	2.05 V
K3	2.05 V	2.20 V
N3	2.20 V	2.35 V
R3	2.35 V	2.50 V

Wavelength Groups

Group	Dominant Wavelength ³⁾ $I_F = 4 \text{ mA}$ min. λ_{dom}	Dominant Wavelength ³⁾ $I_F = 4 \text{ mA}$ max. λ_{dom}
1	626 nm	637 nm

Wavelength Groups

Group	Dominant Wavelength ³⁾ $I_F = 50 \text{ mA}$ min. λ_{dom}	Dominant Wavelength ³⁾ $I_F = 50 \text{ mA}$ max. λ_{dom}
6	627 nm	630 nm
7	630 nm	634 nm
8	634 nm	637 nm

Relative Spectral Emission ⁶⁾

$I_{rel} = f(\lambda); I_F = 50 \text{ mA}; T_S = 25 \text{ }^\circ\text{C}$

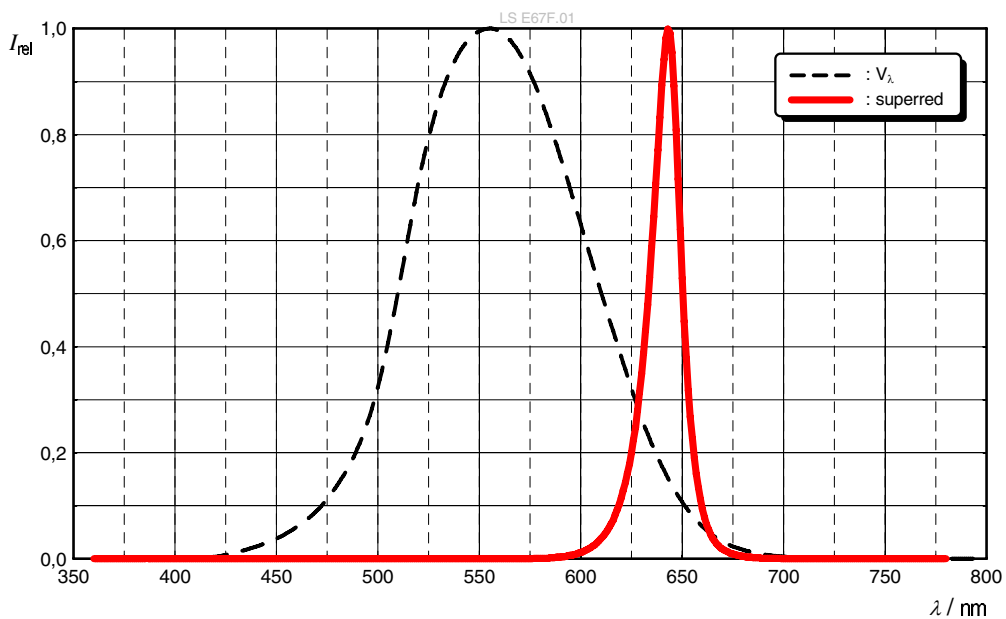

Radiation Characteristics ⁶⁾

$I_{rel} = f(\varphi); T_S = 25 \text{ }^\circ\text{C}$

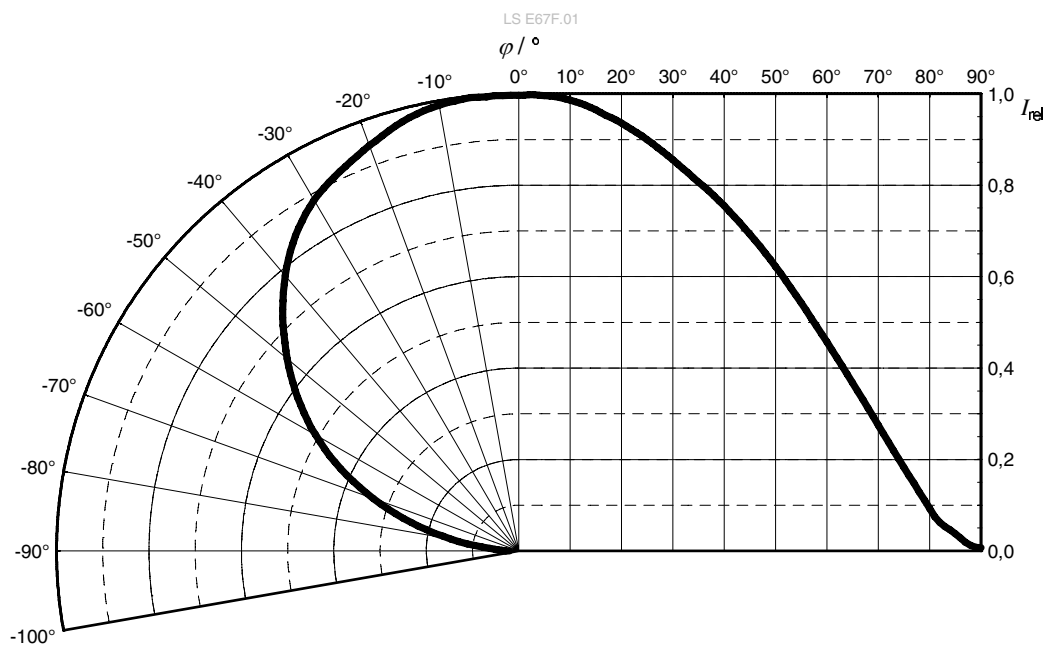

Forward current ^{6), 7)}

$$I_F = f(V_F); T_S = 25\text{ °C}$$

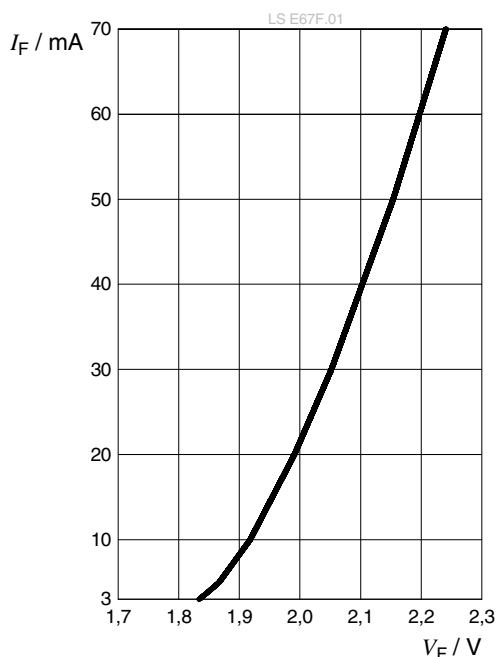

Relative Luminous Intensity ^{6), 7)}

$$I_V / I_V(I_{F\text{ group}}) = f(I_F); T_S = 25\text{ °C}$$

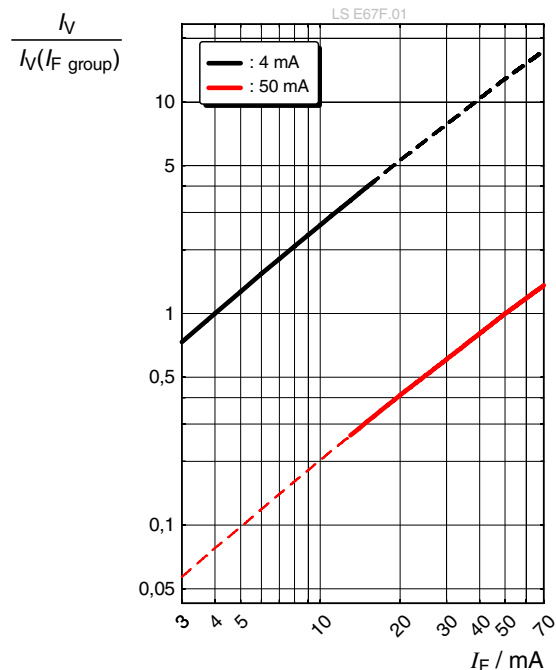

Dominant Wavelength ⁶⁾

$$\Delta\lambda_{\text{dom}} = f(I_F); T_S = 25\text{ °C}$$

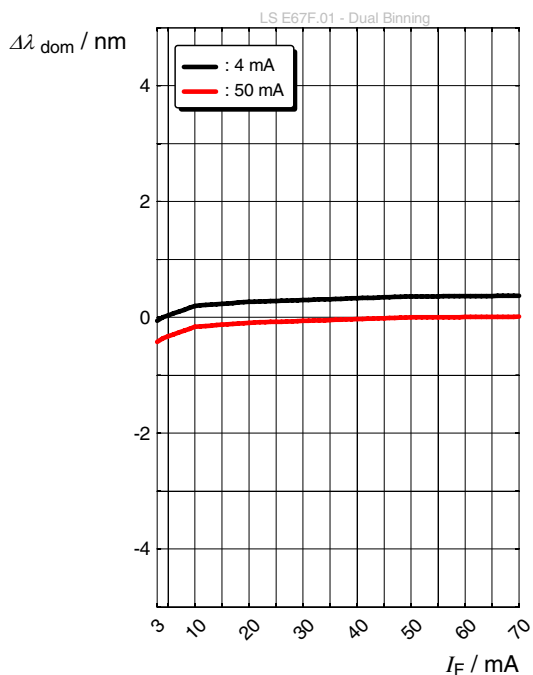

Forward Voltage ⁶⁾

$$\Delta V_F = V_F - V_F(25\text{ }^\circ\text{C}) = f(T_j); I_F = 50\text{ mA}$$

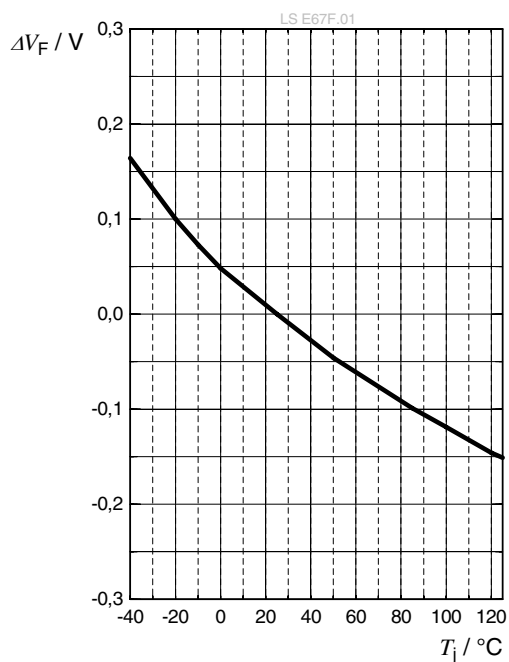

Relative Luminous Intensity ⁶⁾

$$I_V / I_V(25\text{ }^\circ\text{C}) = f(T_j); I_F = 50\text{ mA}$$

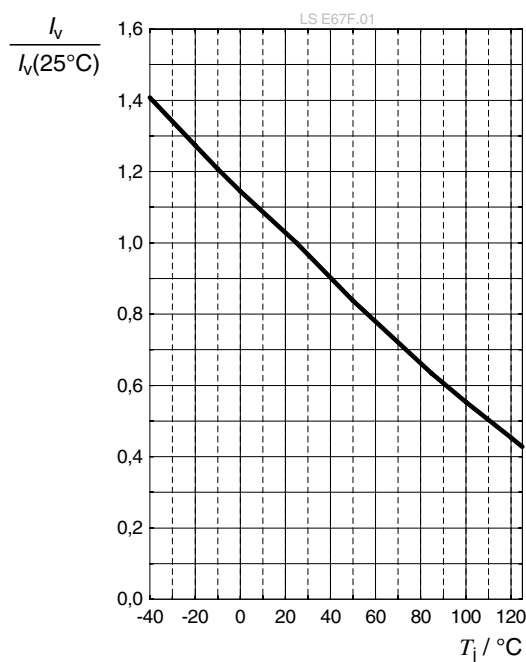

Dominant Wavelength ⁶⁾

$$\Delta \lambda_{\text{dom}} = \lambda_{\text{dom}} - \lambda_{\text{dom}}(25\text{ }^\circ\text{C}) = f(T_j); I_F = 50\text{ mA}$$

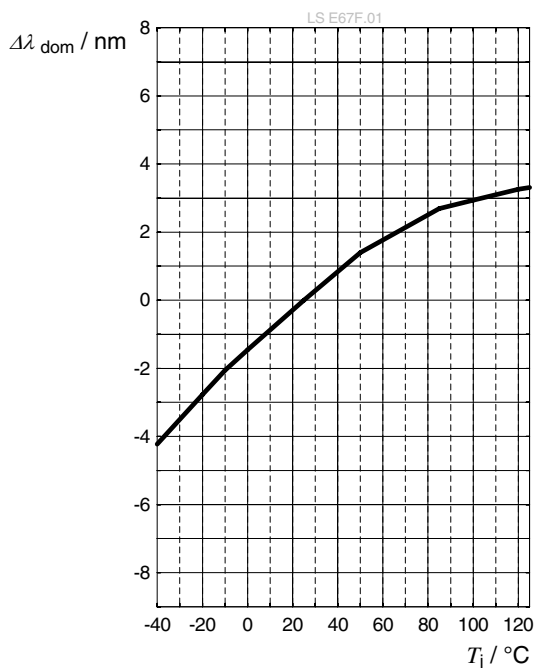

Max. Permissible Forward Current ⁵⁾

$I_F = f(T)$

LS E67F.01 - Dual Binning

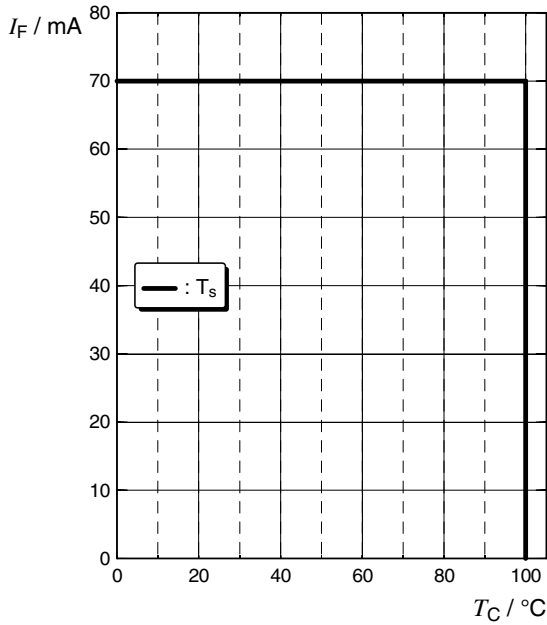

Permissible Pulse Handling Capability

$I_F = f(t_p)$; D: Duty cycle; $T_s = 25\text{ °C}$

LS E67F.01 - Dual Binning

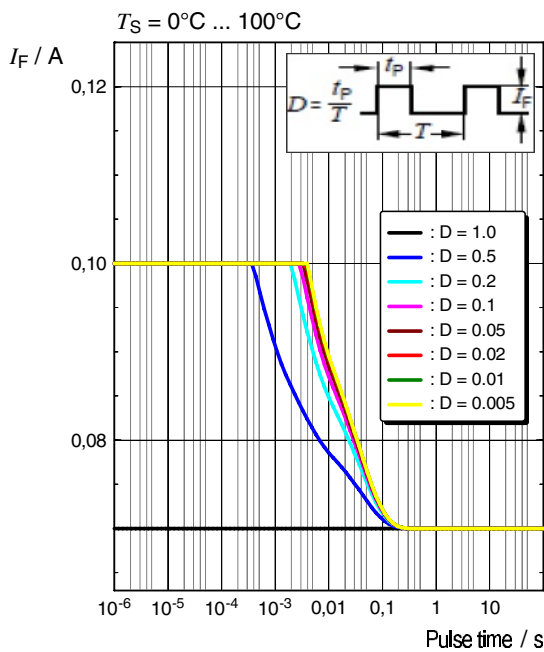

Dimensional Drawing ⁸⁾

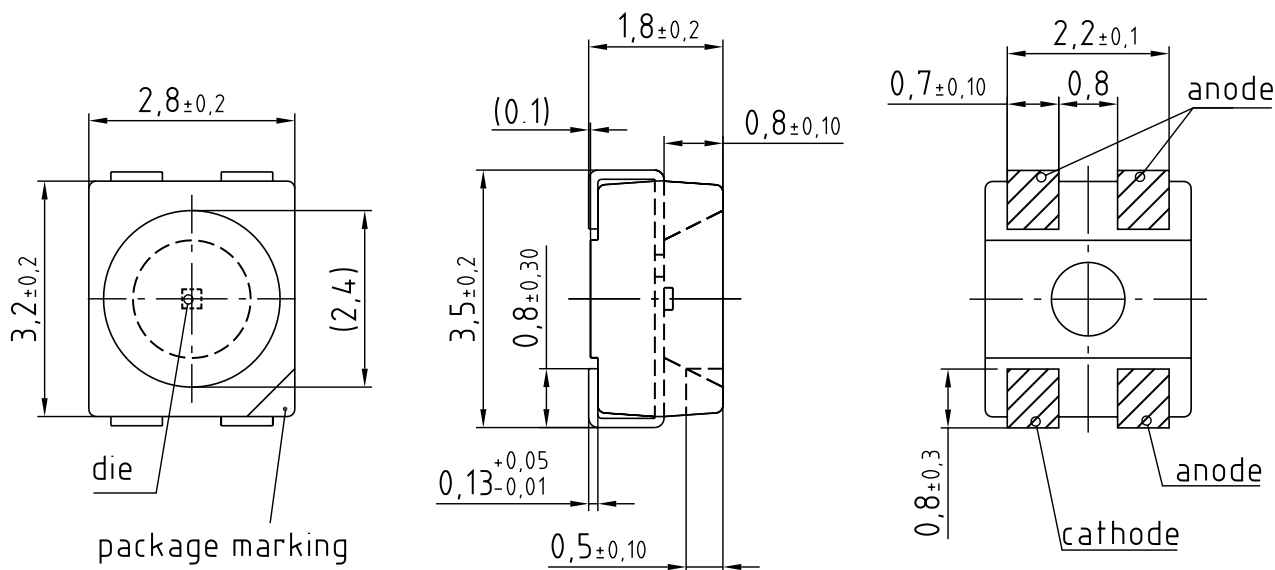

C63062-A3861-A6..-04

Further Information:

Approximate Weight: 30.0 mg

Package marking: Cathode

Corrosion test: Class: 3B

Test condition: 40°C / 90 % RH / 15 ppm H₂S / 14 days (stricter than IEC 60068-2-43)

Electrical Internal Circuit

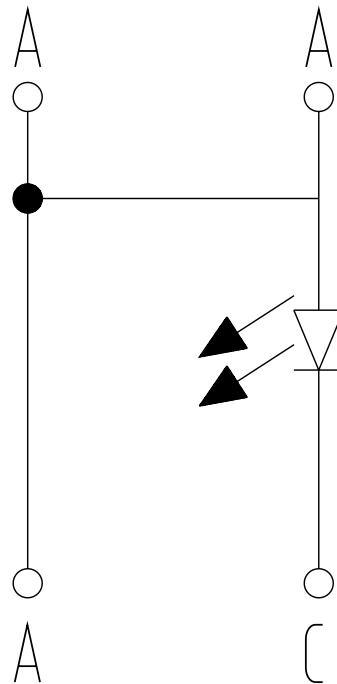

Recommended Solder Pad ⁸⁾

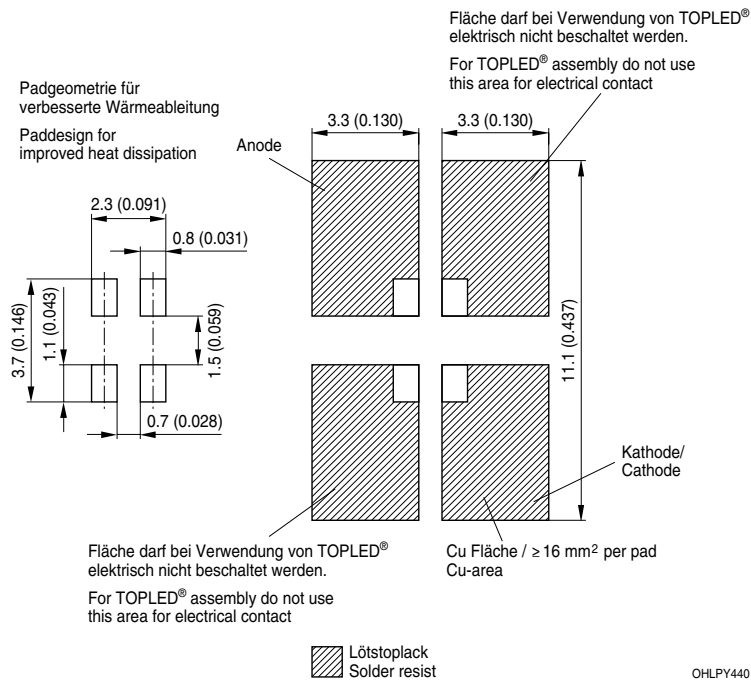

For superior solder joint connectivity results we recommend soldering under standard nitrogen atmosphere. Package not suitable for ultra sonic cleaning.

Reflow Soldering Profile

Product complies to MSL Level 2 acc. to JEDEC J-STD-020E

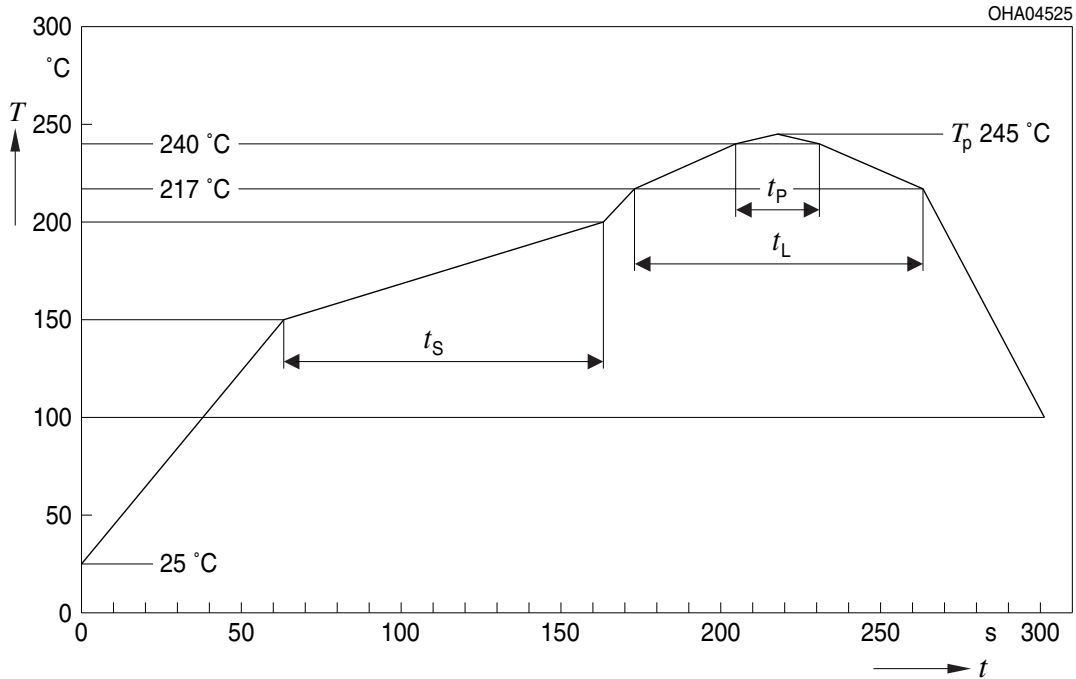

Profile Feature	Symbol	Pb-Free (SnAgCu) Assembly			Unit
		Minimum	Recommendation	Maximum	
Ramp-up rate to preheat ^{*)} 25 °C to 150 °C			2	3	K/s
Time t_s T_{Smin} to T_{Smax}	t_s	60	100	120	s
Ramp-up rate to peak ^{*)} T_{Smax} to T_p			2	3	K/s
Liquidus temperature	T_L		217		°C
Time above liquidus temperature	t_L		80	100	s
Peak temperature	T_p		245	260	°C
Time within 5 °C of the specified peak temperature $T_p - 5$ K	t_p	10	20	30	s
Ramp-down rate* T_p to 100 °C			3	6	K/s
Time 25 °C to T_p				480	s

All temperatures refer to the center of the package, measured on the top of the component

* slope calculation DT/Dt : Dt max. 5 s; fulfillment for the whole T-range

Taping ⁸⁾

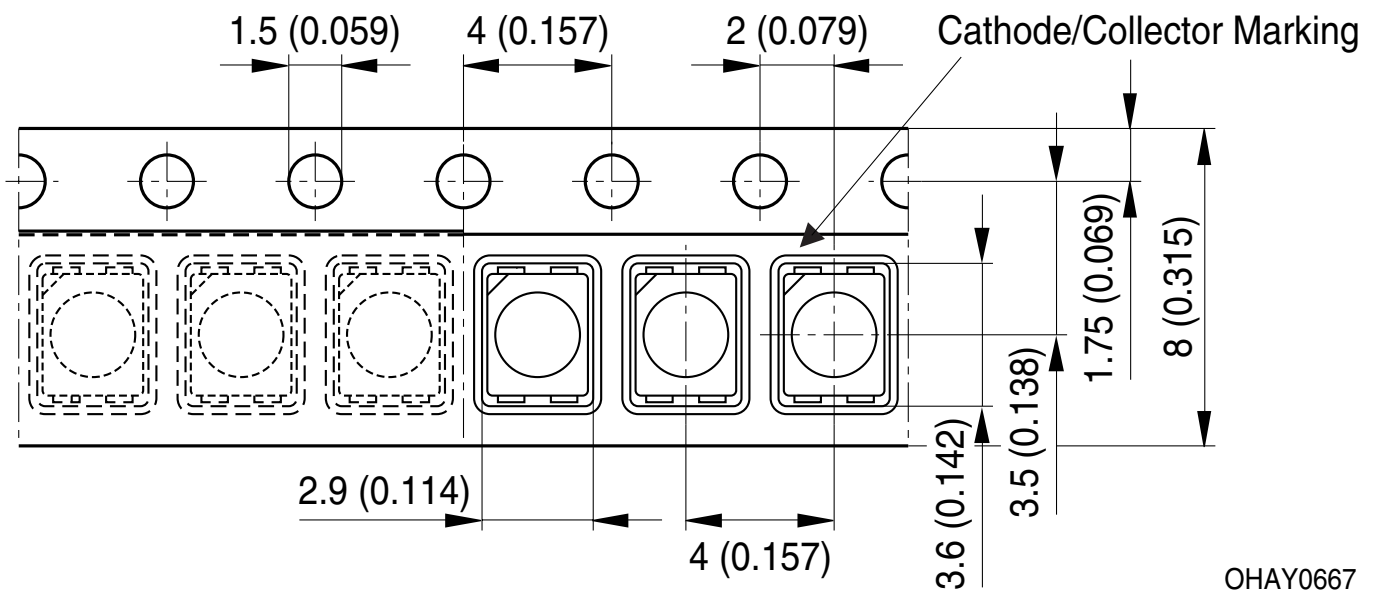

OHAY0667

Tape and Reel ⁹⁾

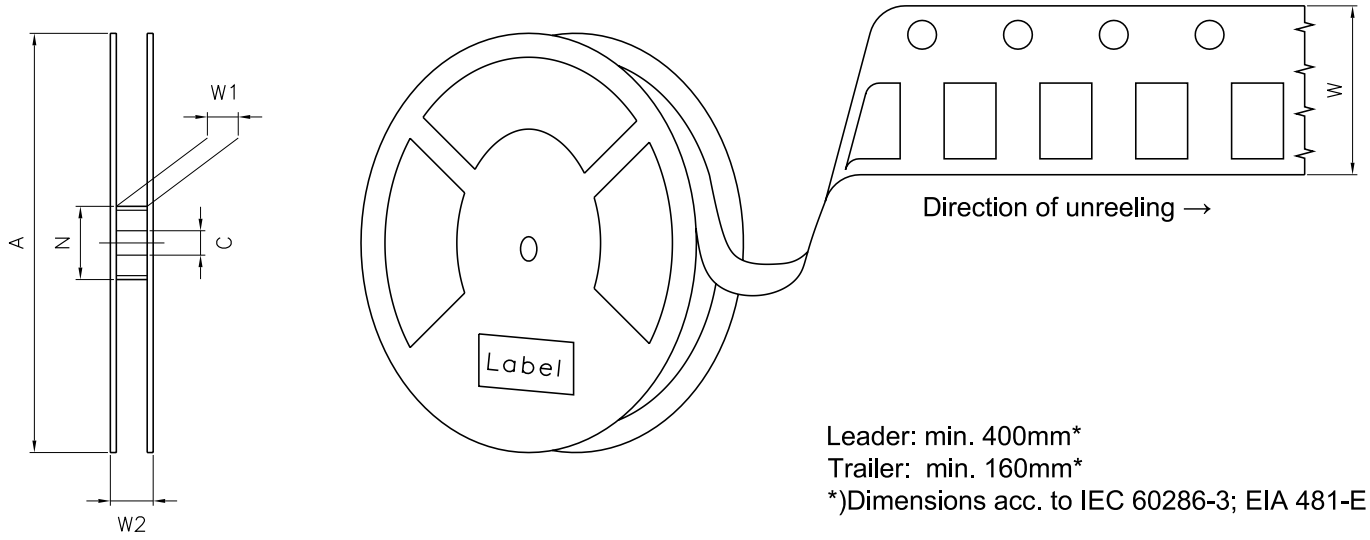

Reel Dimensions

A	W	N_{\min}	W_1	$W_{2\max}$	Pieces per PU
180 mm	$8 + 0.3 / - 0.1$ mm	60 mm	$8.4 + 2$ mm	14.4 mm	2000

Barcode-Product-Label (BPL)

OSRAM LX XXXX BIN1: XX-XX-X-XXX-X





RoHS Compliant

(6P) BATCH NO: 1234567890 ML Temp ST
X XXX °C X

(1T) LOT NO: 1234567890 (9D) D/C: 1234

Pack: RXX
DEMY XXX
X_X123_1234.1234 X

(X) PROD NO: 123456789(Q)QTY: 9999 (G) GROUP: XX-XX-X-X

OHA04563

Dry Packing Process and Materials ⁸⁾

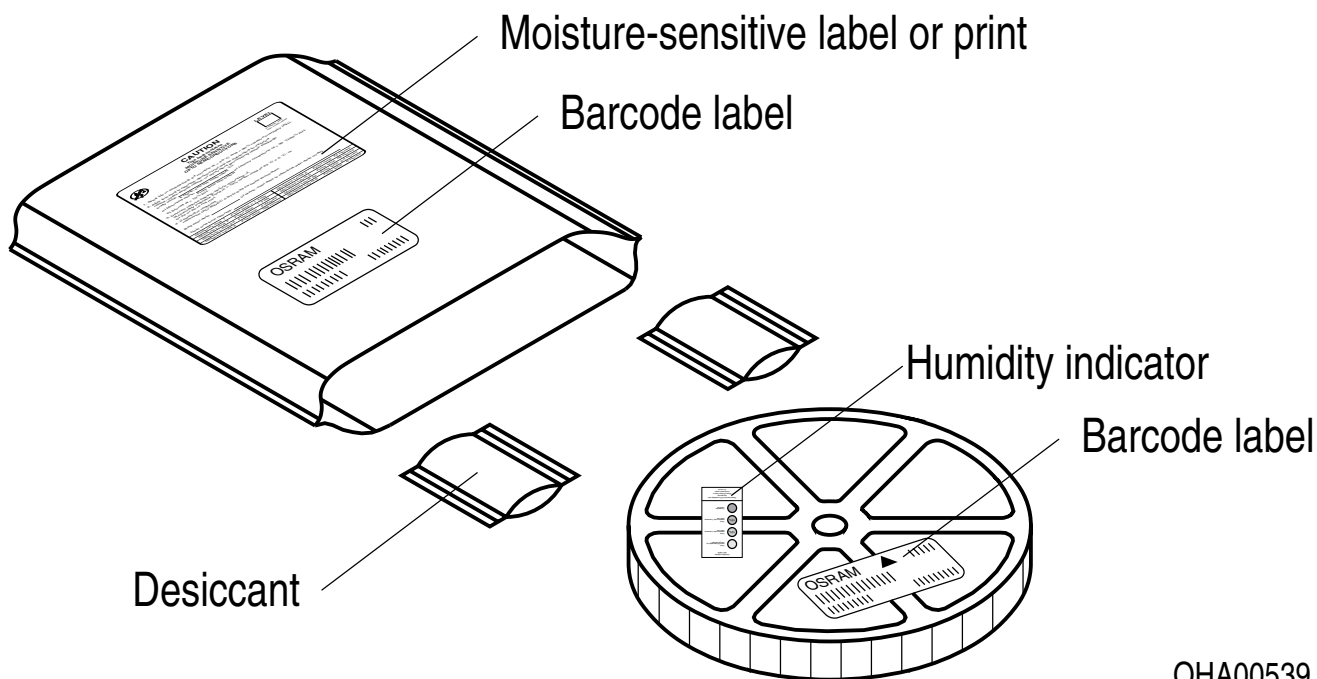

OHA00539

Moisture-sensitive product is packed in a dry bag containing desiccant and a humidity card according JEDEC-STD-033.

Notes

The evaluation of eye safety occurs according to the standard IEC 62471:2006 (photo biological safety of lamps and lamp systems). Within the risk grouping system of this IEC standard, the device specified in this data sheet fall into the class **exempt group (exposure time 10000 s)**. Under real circumstances (for exposure time, conditions of the eye pupils, observation distance), it is assumed that no endangerment to the eye exists from these devices. As a matter of principle, however, it should be mentioned that intense light sources have a high secondary exposure potential due to their blinding effect. When looking at bright light sources (e.g. headlights), temporary reduction in visual acuity and afterimages can occur, leading to irritation, annoyance, visual impairment, and even accidents, depending on the situation.

Subcomponents of this device contain, in addition to other substances, metal filled materials including silver. Metal filled materials can be affected by environments that contain traces of aggressive substances. Therefore, we recommend that customers minimize device exposure to aggressive substances during storage, production, and use. Devices that showed visible discoloration when tested using the described tests above did show no performance deviations within failure limits during the stated test duration. Respective failure limits are described in the IEC60810.

For further application related information please visit <https://ams-osram.com/support/application-notes>

Disclaimer

Attention please!

The information describes the type of component and shall not be considered as assured characteristics. Terms of delivery and rights to change design reserved. Due to technical requirements components may contain dangerous substances.

For information on the types in question please contact our Sales Organization.

If printed or downloaded, please find the latest version on our website.

Packing

Please use the recycling operators known to you. We can also help you – get in touch with your nearest sales office. By agreement we will take packing material back, if it is sorted. You must bear the costs of transport. For packing material that is returned to us unsorted or which we are not obliged to accept, we shall have to invoice you for any costs incurred.

Product and functional safety devices/applications or medical devices/applications

Our components are not developed, constructed or tested for the application as safety relevant component or for the application in medical devices.

Our products are not qualified at module and system level for such application.

In case buyer – or customer supplied by buyer – considers using our components in product safety devices/ applications or medical devices/applications, buyer and/or customer has to inform our local sales partner immediately and we and buyer and /or customer will analyze and coordinate the customer-specific request between us and buyer and/or customer.

Glossary

- 1) **Brightness:** Brightness values are measured during a current pulse of typically 25 ms, with an internal reproducibility of $\pm 8\%$ and an expanded uncertainty of $\pm 11\%$ (acc. to GUM with a coverage factor of $k = 3$).
- 2) **Reverse Operation:** This product is intended to be operated applying a forward current within the specified range. Applying any continuous reverse bias or forward bias below the voltage range of light emission shall be avoided because it may cause migration which can change the electro-optical characteristics or damage the LED.
- 3) **Wavelength:** The wavelength is measured at a current pulse of typically 25 ms, with an internal reproducibility of ± 0.5 nm and an expanded uncertainty of ± 1 nm (acc. to GUM with a coverage factor of $k = 3$).
- 4) **Forward Voltage:** The forward voltage is measured during a current pulse of typically 8 ms, with an internal reproducibility of ± 0.05 V and an expanded uncertainty of ± 0.1 V (acc. to GUM with a coverage factor of $k = 3$).
- 5) **Thermal Resistance:** $R_{th\ max}$ is based on statistic values (6σ) used for Derating.
- 6) **Typical Values:** Due to the special conditions of the manufacturing processes of semiconductor devices, the typical data or calculated correlations of technical parameters can only reflect statistical figures. These do not necessarily correspond to the actual parameters of each single product, which could differ from the typical data and calculated correlations or the typical characteristic line. If requested, e.g. because of technical improvements, these typ. data will be changed without any further notice.
- 7) **Characteristic curve:** In the range where the line of the graph is broken, you must expect higher differences between single devices within one packing unit.
- 8) **Tolerance of Measure:** Unless otherwise noted in drawing, tolerances are specified with ± 0.1 and dimensions are specified in mm.
- 9) **Tape and Reel:** All dimensions and tolerances are specified acc. IEC 60286-3 and specified in mm.

Revision History

Version	Date	Change
1.0	2024-06-07	Initial Version
1.1	2024-07-29	Features



EU RoHS and China RoHS compliant product

此产品符合欧盟 RoHS 指令的要求；
按照中国的相关法规和标准，
不含有毒有害物质或元素。

Published by ams-OSRAM AG

Tobelbader Strasse 30, 8141 Premstaetten, Austria

Phone +43 3136 500-0

ams-osram.com

© All rights reserved

ams  **OSRAM**