

**Applications**

- High Frequency Point-of-Load Synchronous Buck Converter for Applications in Networking & Computing Systems.
- Lead-Free

**Benefits**

- Very Low  $R_{DS(on)}$  at 4.5V  $V_{GS}$
- Low Gate Charge
- Fully Characterized Avalanche Voltage and Current

**Features**

- $V_{DS(V)} = 30V$
- $I_D = 13 A$  ( $V_{GS} = 10V$ )
- $R_{DS(ON)} < 9.1m\Omega$  ( $V_{GS}=10V$ )
- $R_{DS(ON)} < 12.5 m\Omega$  ( $V_{GS}=4.5V$ )

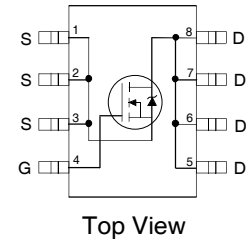

**Absolute Maximum Ratings**

	Parameter	Max.	Units
$V_{DS}$	Drain-to-Source Voltage	30	V
$V_{GS}$	Gate-to-Source Voltage	$\pm 20$	
$I_D @ T_A = 25^\circ C$	Continuous Drain Current, $V_{GS} @ 10V$	13.6	A
$I_D @ T_A = 70^\circ C$	Continuous Drain Current, $V_{GS} @ 10V$	11	
$I_{DM}$	Pulsed Drain Current ①	100	
$P_D @ T_A = 25^\circ C$	Power Dissipation ④	2.5	W
$P_D @ T_A = 70^\circ C$	Power Dissipation ④	1.6	
	Linear Derating Factor	0.02	W/°C
$T_J$ $T_{STG}$	Operating Junction and Storage Temperature Range	-55 to + 155	°C

**Thermal Resistance**

	Parameter	Typ.	Max.	Units
$R_{\theta JL}$	Junction-to-Drain Lead ⑤		20	°C/W
$R_{\theta JA}$	Junction-to-Ambient ④⑤		50	

### Static @ $T_J = 25^\circ\text{C}$ (unless otherwise specified)

	Parameter	Min.	Typ.	Max.	Units	Conditions
$BV_{DSS}$	Drain-to-Source Breakdown Voltage	30			V	$V_{GS} = 0V, I_D = 250\mu A$
$\Delta BV_{DSS}/\Delta T_J$	Breakdown Voltage Temp. Coefficient		0.025		V/ $^\circ\text{C}$	Reference to $25^\circ\text{C}, I_D = 1mA$
$R_{DS(on)}$	Static Drain-to-Source On-Resistance		7.0	9.1	m $\Omega$	$V_{GS} = 10V, I_D = 13A$ ③
			9.5	12.5		$V_{GS} = 4.5V, I_D = 10A$ ③
$V_{GS(th)}$	Gate Threshold Voltage	1.0			V	$V_{DS} = V_{GS}, I_D = 250\mu A$
$\Delta V_{GS(th)}$	Gate Threshold Voltage Coefficient		-4.9		mV/ $^\circ\text{C}$	
$I_{DSS}$	Drain-to-Source Leakage Current			1.0	$\mu A$	$V_{DS} = 24V, V_{GS} = 0V$
				150		$V_{DS} = 24V, V_{GS} = 0V, T_J = 125^\circ\text{C}$
$I_{GSS}$	Gate-to-Source Forward Leakage			100	nA	$V_{GS} = 20V$
	Gate-to-Source Reverse Leakage			-100		$V_{GS} = -20V$
$g_{fs}$	Forward Transconductance	22			S	$V_{DS} = 15V, I_D = 10A$
$Q_g$	Total Gate Charge		9.3	14	nC	$V_{DS} = 15V$ $V_{GS} = 4.5V$ $I_D = 10A$ See Fig. 16
$Q_{gs1}$	Pre-Vth Gate-to-Source Charge		2.5			
$Q_{gs2}$	Post-Vth Gate-to-Source Charge		0.8			
$Q_{gd}$	Gate-to-Drain Charge		2.9			
$Q_{godr}$	Gate Charge Overdrive		3.1			
$Q_{sw}$	Switch Charge ( $Q_{gs2} + Q_{gd}$ )		3.7			
$Q_{oss}$	Output Charge		6.1			
$t_{d(on)}$	Turn-On Delay Time		6.3		ns	$V_{DD} = 15V, V_{GS} = 4.5V$ ③ $I_D = 10A$ Clamped Inductive Load
$t_r$	Rise Time		2.7			
$t_{d(off)}$	Turn-Off Delay Time		9.7			
$t_f$	Fall Time		7.3			
$C_{iss}$	Input Capacitance		1010		pF	$V_{GS} = 0V$ $V_{DS} = 15V$ $f = 1.0MHz$
$C_{oss}$	Output Capacitance		360			
$C_{rss}$	Reverse Transfer Capacitance		110			

### Avalanche Characteristics

	Parameter	Typ.	Max.	Units
$E_{AS}$	Single Pulse Avalanche Energy ②⑥		44	mJ
$I_{AR}$	Avalanche Current ①		10	A

### Diode Characteristics

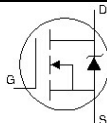
	Parameter	Min.	Typ.	Max.	Units	Conditions
$I_S$	Continuous Source Current (Body Diode)			3.1	A	MOSFET symbol showing the integral reverse p-n junction diode. 
$I_{SM}$	Pulsed Source Current (Body Diode) ①⑥			100		
$V_{SD}$	Diode Forward Voltage			1.0	V	$T_J = 25^\circ\text{C}, I_S = 10A, V_{GS} = 0V$ ③
$t_{rr}$	Reverse Recovery Time		28	42	ns	$T_J = 25^\circ\text{C}, I_F = 10A, V_{DD} = 20V$
$Q_{rr}$	Reverse Recovery Charge		23	35	nC	$di/dt = 100A/\mu s$ ③

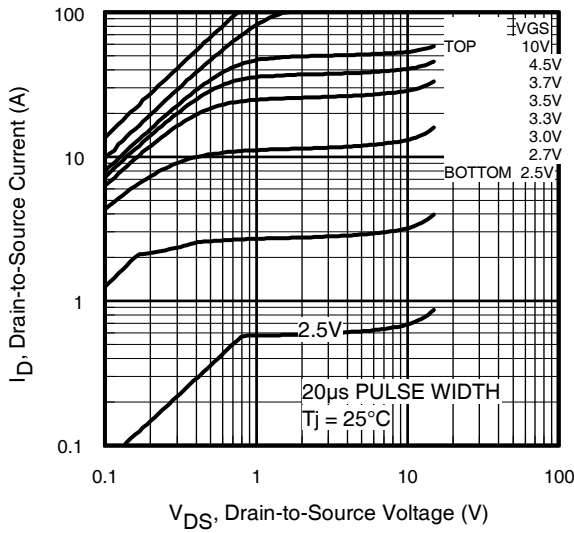

Fig 1. Typical Output Characteristics

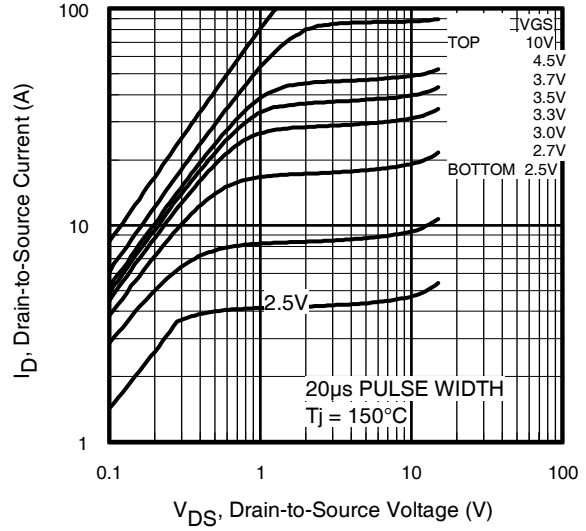

Fig 2. Typical Output Characteristics

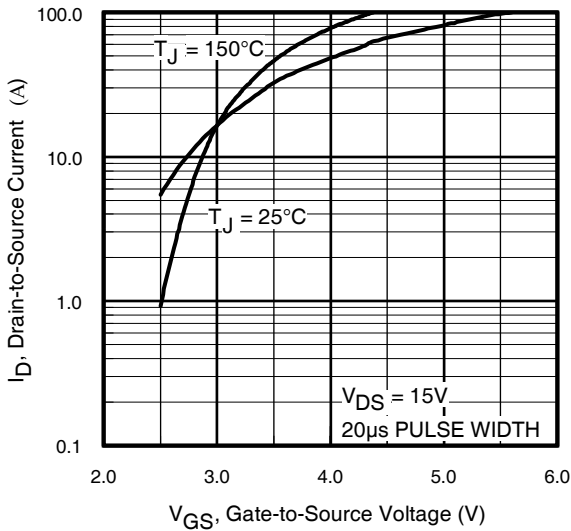

Fig 3. Typical Transfer Characteristics

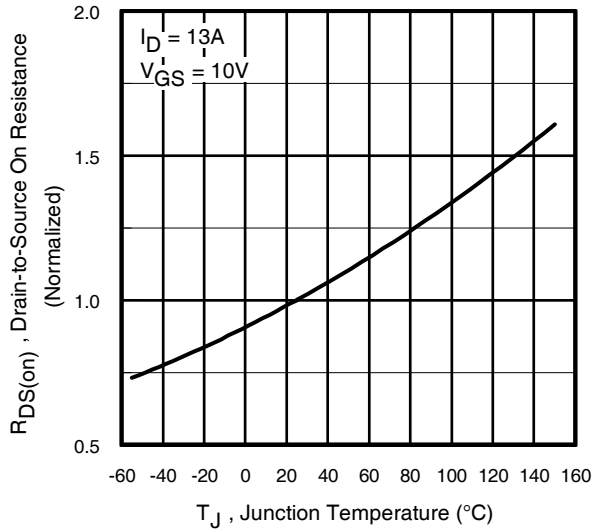
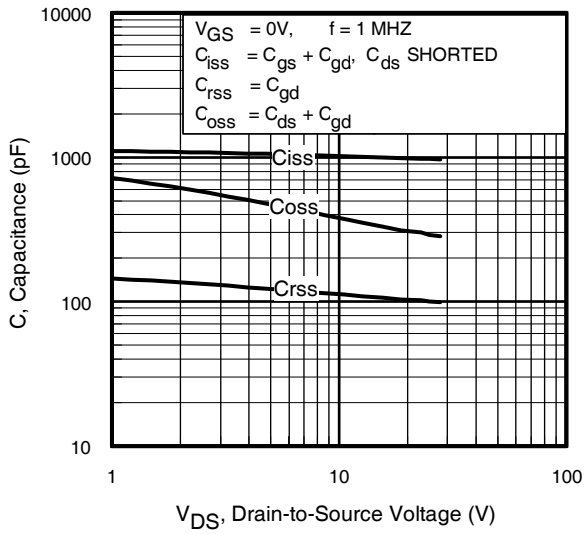
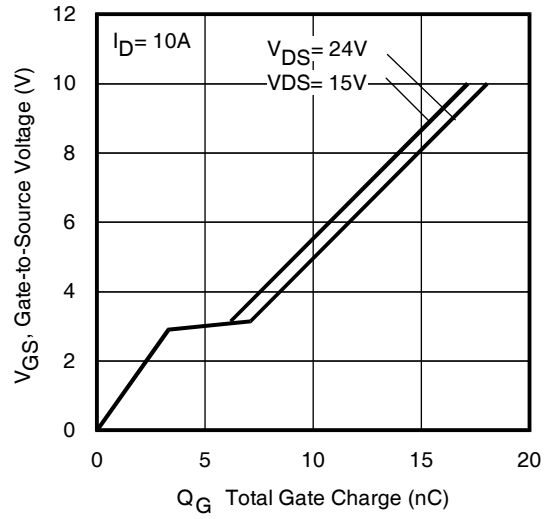

Fig 4. Normalized On-Resistance Vs. Temperature



**Fig 5.** Typical Capacitance Vs. Drain-to-Source Voltage



**Fig 6.** Typical Gate Charge Vs. Gate-to-Source Voltage

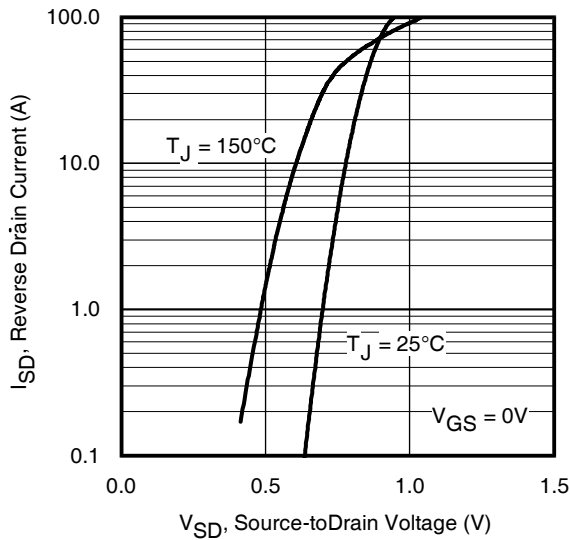

**Fig 7.** Typical Source-Drain Diode Forward Voltage

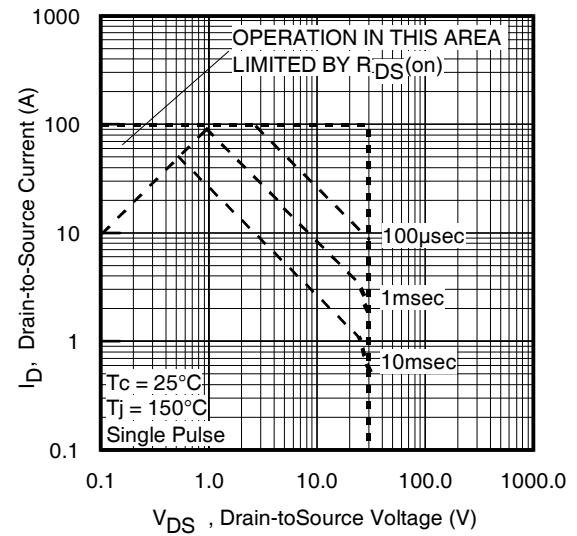

**Fig 8.** Maximum Safe Operating Area

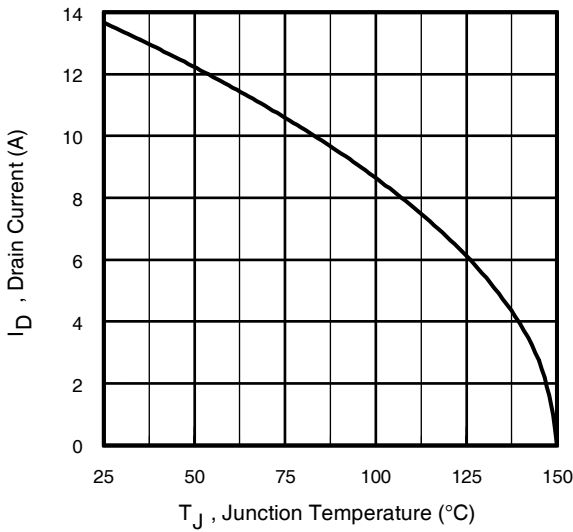

Fig 9. Maximum Drain Current Vs. Case Temperature

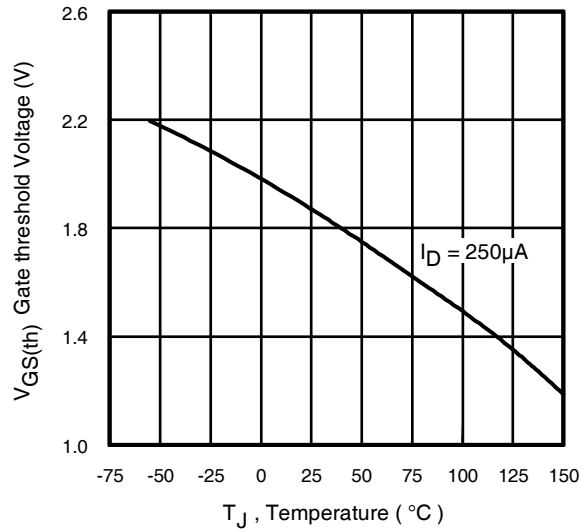

Fig 10. Threshold Voltage Vs. Temperature

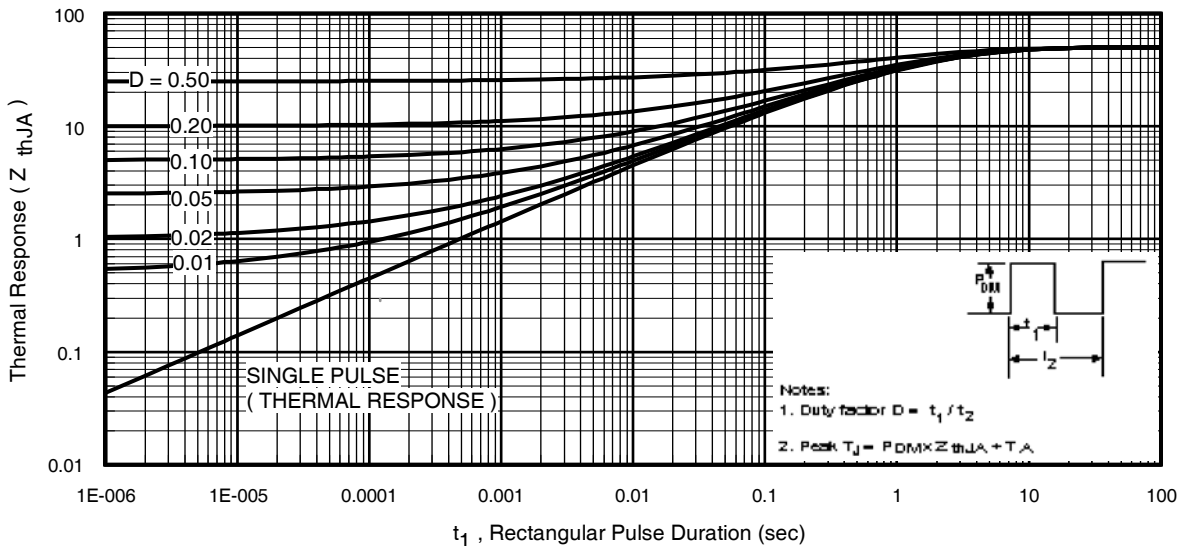

Fig 11. Maximum Effective Transient Thermal Impedance, Junction-to-Ambient

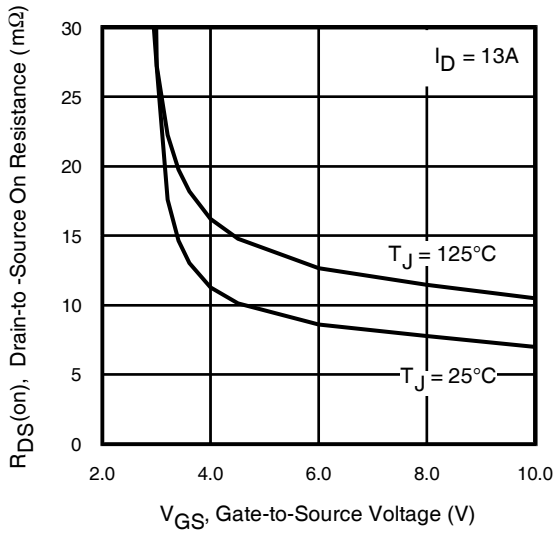

Fig 12. On-Resistance Vs. Gate Voltage

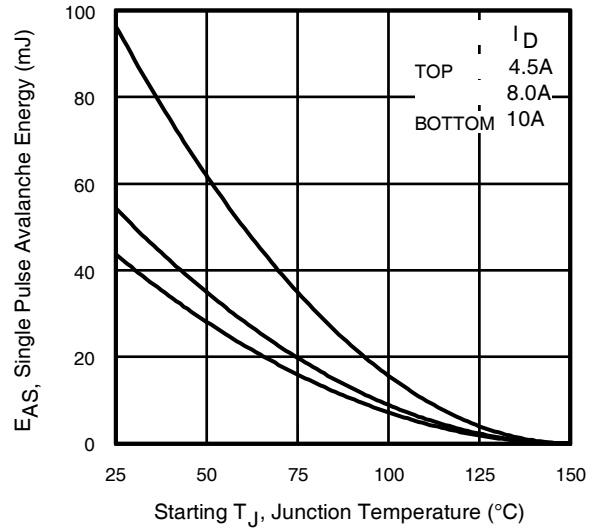

Fig 13c. Maximum Avalanche Energy Vs. Drain Current

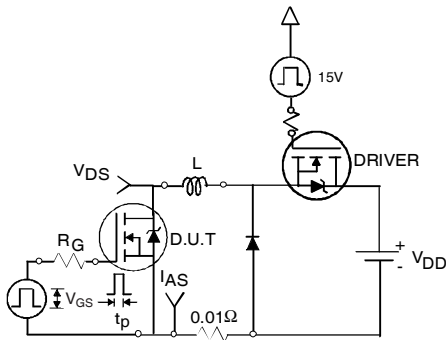

Fig 13a. Unclamped Inductive Test Circuit

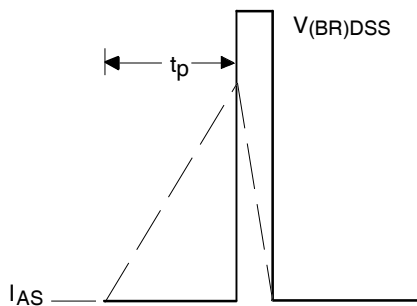

Fig 13b. Unclamped Inductive Waveforms

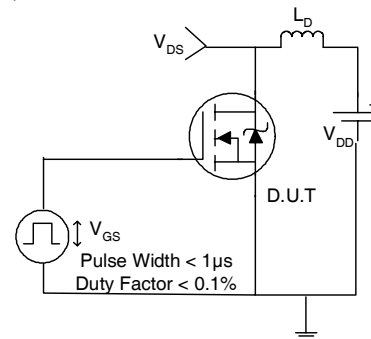

Fig 14a. Switching Time Test Circuit

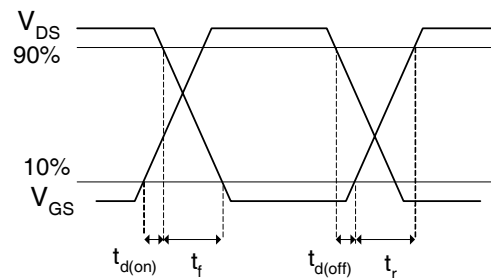

Fig 14b. Switching Time Waveforms

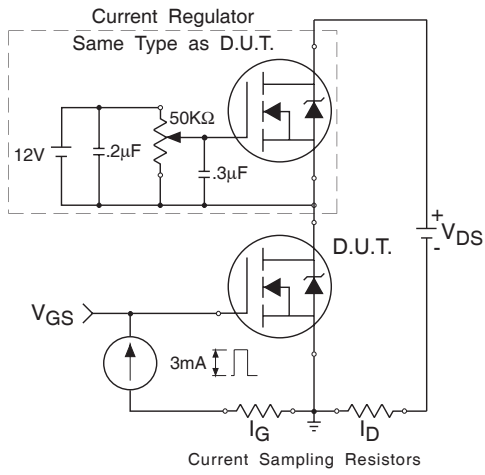

Fig 15. Gate Charge Test Circuit

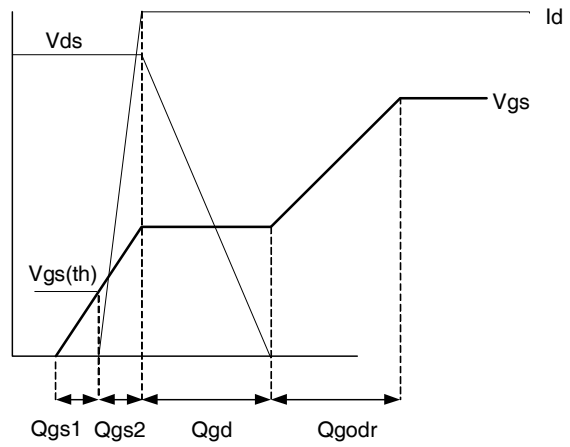
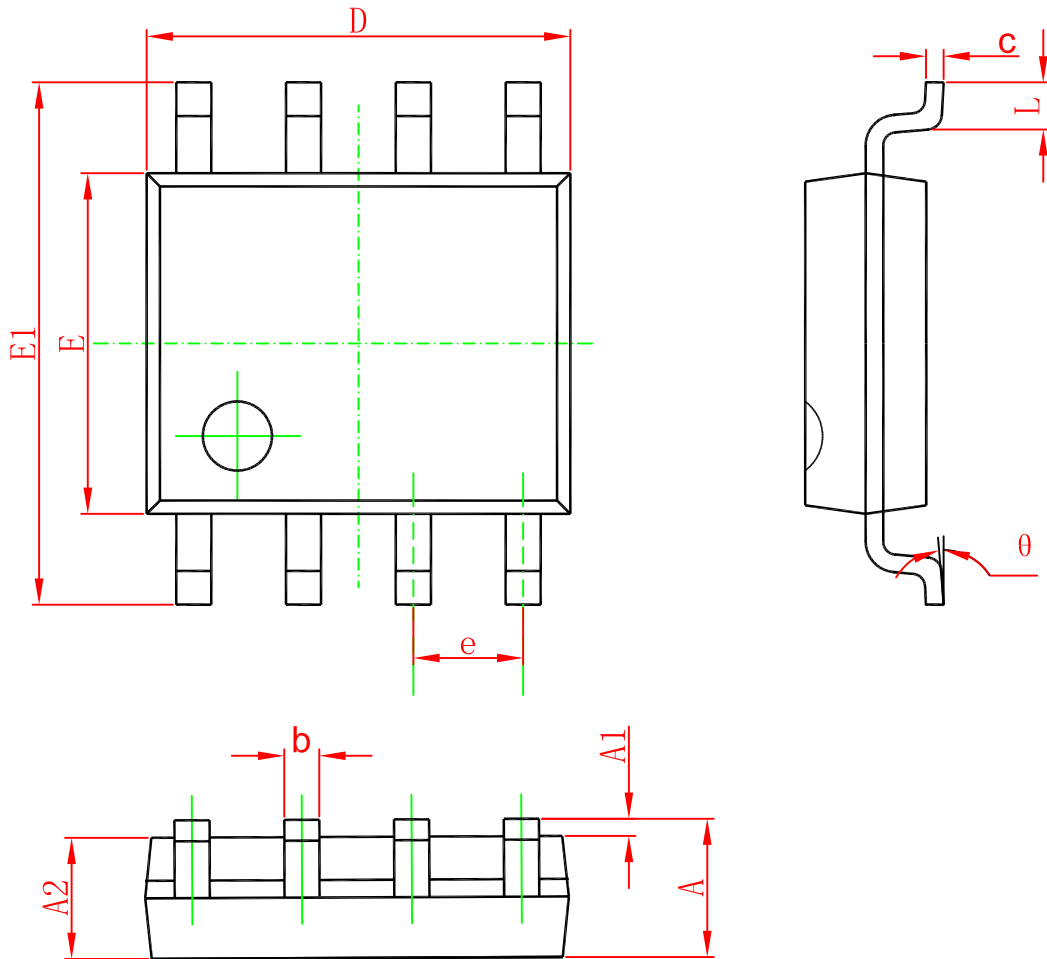

Fig 16. Gate Charge Waveform

Package Mechanical Data SOP-8



Symbol	Dimensions In Millimeters		Dimensions In Inches	
	Min	Max	Min	Max
A	1.350	1.750	0.053	0.069
A1	0.100	0.250	0.004	0.010
A2	1.350	1.550	0.053	0.061
b	0.330	0.510	0.013	0.020
c	0.170	0.250	0.006	0.010
D	4.700	5.100	0.185	0.200
E	3.800	4.000	0.150	0.157
E1	5.800	6.200	0.228	0.244
e	1.270(BSC)		0.050(BSC)	
L	0.400	1.270	0.016	0.050
θ	0°	8°	0°	8°



**Marking**

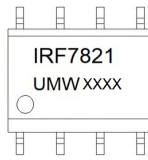

**Ordering information**

Order code	Package	Baseqty	Deliverymode
UMW IRF7821TR	SOP-8	3000	Tape and reel