

# Forget Safety Wire (Lockwire)

## Now There's

# Safe-T-Cable®



Typical  
3-Fastener  
Safety Wire  
Installation

**1:42\***  
1 min. 42 sec.

Typical  
3-Fastener  
Safe-T-Cable®  
Installation

**0:36\***  
36 sec.



## Time-Saving Technology...

Safe-T-Cable® may be substituted, in many applications, for hand-twisted safety wire.  
Safe-T-Cable® will improve the efficiency and quality of your assembly operations.

**DMC** **DANIELS  
MANUFACTURING  
CORPORATION**®

an ISO9100:2008 and AS9100:2004  
Registered Company, ROHS Compliant

# Save Time and Money By Replacing Your Old Safety Wire System With... **Safe-T-Cable**<sup>®</sup>



In 1989, GE Aircraft Engine Company (GEAE) invented Safety Cable for use on its Commercial Aircraft Engines. Considerable amounts of time and expense were dedicated to refining this product and testing its performance.

In 1993, GEAE was issued a Patent on Safety Cable, and DMC became a Licensee of the Patent. Also in 1993 the first industry specifications were released. Through almost two decades of use, and millions of installations, Safe-T-Cable has proven to be a reliable fastener security system, and has saved several thousands of hours in the manufacturing and maintenance of Aerospace and Transportation Systems.

## **System Benefits**

- Improved Security Of Fasteners
- Reduced Installation And Inspection Time
- Improved Access To Tight Areas
- Consistent Cable Tension On Each Application
- Considerable Reduction Of Rework
- Simplified Installation Procedures
- Minimal Operator Training Is Required
- Lighter Weight Than Safety Wire
- Eliminates Injuries Due To Sharp Safety Wire Ends
- User Friendly Tooling
- Reduces Risk Of Carpal Tunnel Injuries

**DMC** DANIELS<sup>®</sup>  
MANUFACTURING  
CORPORATION

526 THORPE ROAD • ORLANDO, FL 32824-8133 USA  
(407) 855-6161 • FAX (407) 855-6884  
E-MAIL: DMC@DMCTOOLS.COM • WWW.DMCTOOLS.COM

# The Complete Fastener Retention System...



Table of Contents	
General Information.....	2
About DMC.....	3
Approvals and Recognitions.....	4
DMC Statement on Safe-T-Cable®.....	5
Safe-T-Cable® Users.....	5
Safe-T-Cable® Part Numbering System.....	6
Safe-T-Cable® Kits, Assemblies, and Ferrules.....	7
Elongated Ferrules.....	8
Fiberglass Sleeving.....	8
Filler Washer.....	8
Self-Looping Safe-T-Cable®.....	9
Branded Safe-T-Cable®.....	9
Application Tools.....	10
Tool Accessories.....	11
Verification Equipment.....	12
Safe-T-Cable® Tool Kits.....	14
.062 Diameter Safe-T-Cable®.....	16
Installation Practices Guide.....	18
National Stock Number Listings.....	22
FAA Classification Letter.....	24
F.A.R. Reference.....	25
Limited Warranty.....	25

# Safe-T-Cable®

## The Steps are Simple...

### 1. THREAD



A Cable Assembly is threaded through the fasteners in a direction which will exert a positive or neutral pull when tension is applied.

### 2. INSERT



The ferrule is threaded on the cable and the cable is inserted through the tool nose.

### 3. TENSION



Correct tension is applied with the tool.

### 4. CRIMP & CUT



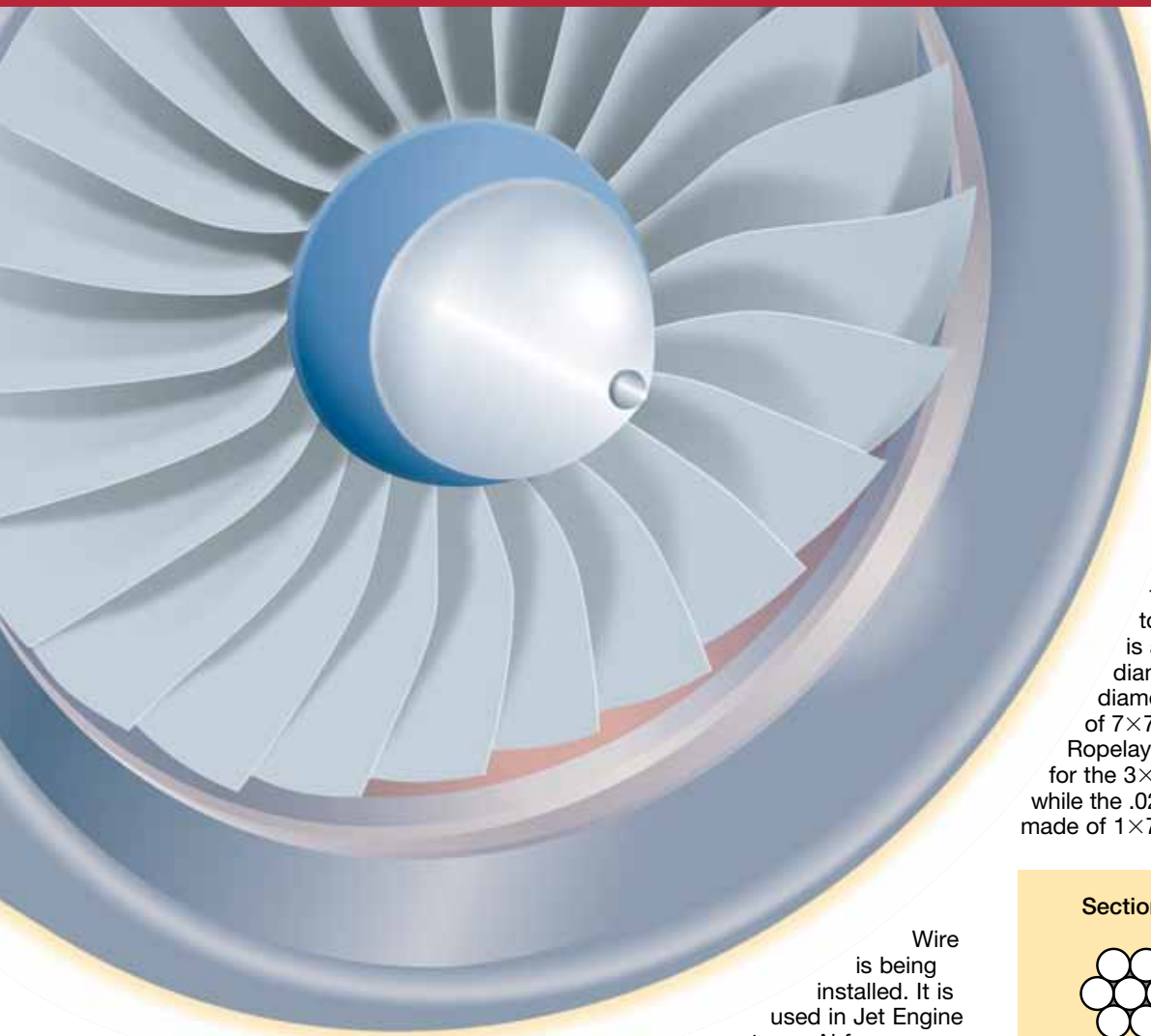
The ferrule is firmly crimped, and the cable is cut flush with the end of the ferrule.

### 5. JOB IS FINISHED



The job is complete. A secure installation in a fraction of the time it takes to install safety wire.

# Safe-T-Cable® General Information



## Construction

Safe-T-Cable® is constructed of high tensile strength, stranded cable. It is more flexible than its Safety Wire counterpart, although the working diameters are equivalent. This provides a stronger assembly which has greater strength and lighter weight. The cable ends are electrically fused to form an easy threading end.

The cable is pre-cut to various lengths, and is supplied with a square-formed end cap attached to one end. Safe-T-Cable® is available in four nominal diameters. The .040 inch diameter cable is constructed of 7×7 stranded ropelay material. Ropelay construction is also used for the 3×7, .032 inch diameter cable while the .022 inch diameter cable is made of 1×7 unilay material.

## Background

There will always be a need to install constraining (safety) devices to threaded fasteners in applications where vibration, kinetic energy, or the need for high reliability is present. Their purpose is to restrict (to a minimum) the unintentional rotation of the fastener. The traditional method (devised in the early 1900's) is through the use of Hand Twisted Safety Wire (often called Lock wire).

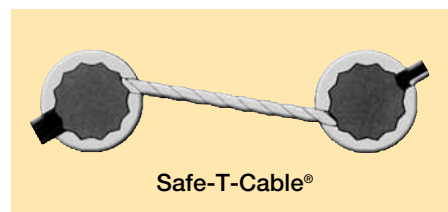


Conventional Safety Wire

The only changes which have occurred since the early uses of Safety Wire are the tremendous costs in the installation of this material, and the levels of sophistication in the systems on which Safety

Wire is being installed. It is used in Jet Engine systems, Airframes, Electronics, Space Vehicles, and Land/Sea based Systems.

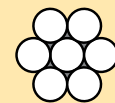
The process of installing Safety Wire remains awkward and costly, and the inspection process is demanding. The removal and rework of installed Safety Wire is a common occurrence.



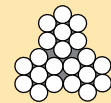
Safe-T-Cable®

Safe-T-Cable® was invented to address these problems in modern Airframe and Engine Systems. The Safe-T-Cable® Kits are consistent in their construction/application, and the user-friendly tooling guarantees a secure and reliable installation each time it is used. Operator training is simple, Inspection is objective, and rework is virtually eliminated. This results in fewer demands on the Operators, Inspectors, and Maintenance personnel.

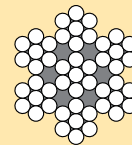
## Sectional View & Application



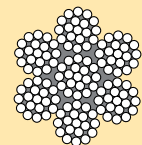
1×7  
(.022/.026")



3×7  
(.032/.038")



7×7  
(.040/.048")

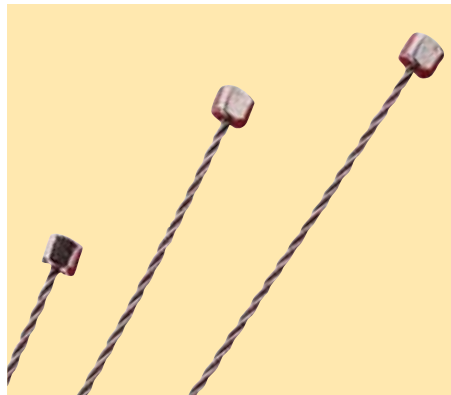


7×19  
(.062/.072")

The ferrules are precisely manufactured to a size and hardness which assures their compatibility with the cable and application tooling. They are supplied (50 pieces each) in an easy loading disposable cartridge, which provides orderly containment of individual ferrules, and the easy release of individual ferrules as they are required. This feature minimizes the possibility of Foreign Object Damage (FOD).

## Testing

The application of Safe-T-Cable® is consistent from one installation to the next due to the repeatability and dependability of the application tooling and the quality of the materials used in the manufacture of Safe-T-Cable® Kits. All that is required to assure overall reliability in manufacturing and maintenance use is a periodic test of a few crimped cable assemblies. DMC offers full instructions and the test equipment to perform these simple tests in either remote or test lab locations.



## Materials

The same high performance alloys used in aerospace fasteners and other components are also used in the construction of Safe-T-Cable® to provide strength and corrosion resistance that is required for durability and long life. All components (End Fitting, Cable, and user applied Ferrule) are made of the same material. 321 Stainless Steel (AS3510) is the most common Safe-T-Cable® material. It is used for most engine and airframe applications. Inconel 600 (AS3509) is appropriate for high temperature and/or non-magnetic applications, and the new Inconel 625 (AS3655) has superior corrosion resistant properties. Consult DMC for further material selection information.

## Safe-T-Cable®

The pre-assembled cables have a square formed end cap securely attached to one end. This provides a positive stop when threaded through a fastener. The other end is electrically fused such that it will easily thread through the series of fasteners that are to be secured. The flexible cable material is lightweight and easy to handle. The stainless steel materials will not corrode or deteriorate while in use. (See chart on the following pages for material, size, and part number.) All Safe-T-Cable® kits and assemblies are supplied 50 pieces per package.

## Ferrules and Cartridge Loading System

The individual crimp ferrules are preloaded into a disposable cartridge unit (50 pieces per cartridge) which allows convenient transportation, storage, and availability of these components. The ferrules are easily extracted individually by threading the cable end through the ferrule, and snapping the ferrule loose. Ferrules do not have to be handled as individual parts and therefore, when properly used, this system minimizes the possibility of Foreign Object Damage (FOD).

## About DMC...

Daniels Manufacturing Corporation was selected to participate in the development of Safe-T-Cable® early in the program based upon our expertise in the design and implementation of crimping, swaging, and fastening tools of many types.

It was a reality to the inventor of Safe-T-Cable® that the quality and repeatability of the application tool is the foundation to success in the development of Safe-T-Cable®.



DMC has been the leading manufacturer of crimping tools for the aircraft, aerospace, and high reliability

electronics industries for over 60 years. Our products are the standards of these industries, and DMC Products/Services are sold throughout the world.



Other DMC Products include: Manual Crimping Tools, Pneumatic, Electric, and Hydraulic Crimping Tools, Backshell/Accessory Torque Tools, Contact Insertion/Removal Tools, EMI/RFI Shielding Banding Tools, Alphatron® Wire Crimp Pull Testers, Fiber Optic Cleave Tools, and Aircraft Maintenance Support Tool Kits.



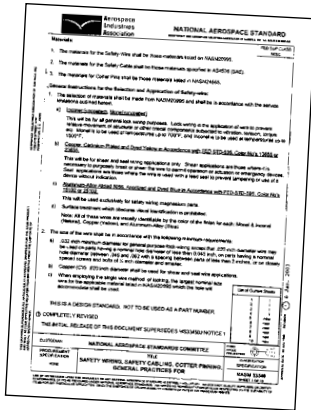
# Safe-T-Cable® Approvals And Recognitions

## U.S. Military

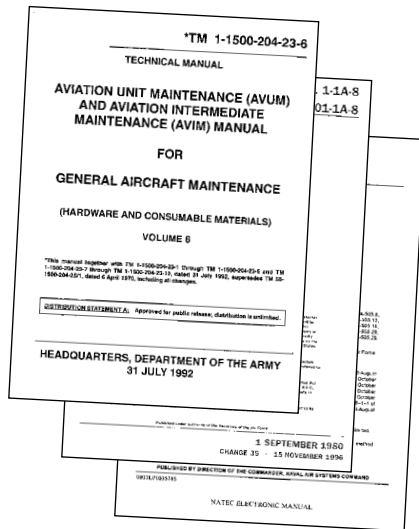
**NASM 33540**  
**(Formerly MIL-STD-33540)**  
**Safety Wiring, Safety Cabling,**  
**Cotter Pinning, General Practices**

This document is called out in many contracts, drawings, and process manuals. Safe-T-Cable® was included in NASM 33540 in revision 1, 6 Jan, 2003. It is published and controlled by AIA

(Aerospace Industries Association)  
<http://www.aia-aerospace.org>  
 1250 Eye Street, Washington DC 20005, and can be purchased on-line at the following web address:  
<http://global.ihs.com/?RID=AIA>



## Technical Manuals (TMs), Technical Orders (TOs), And MS Specs



Many Tech Manuals and Tech Orders that are used by the U.S. Military and Foreign Military Sales Organizations to support Aircraft, Aerospace, and Defense Systems have been revised to include Safe-T-Cable®. The technical information that is required to select, install, and maintain the Safe-T-Cable®

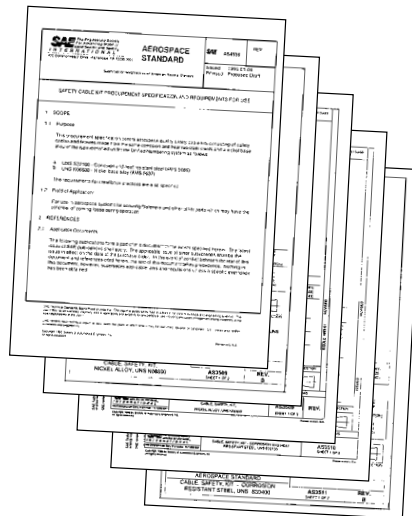
and Application/Verification Tooling is included. The General Tech Manuals/ Tech Orders are the following:

- TO-1-1A-8
- TO-1-1A-14
- TO-1-1A-15
- TM 1-1500-204-23-6
- TM 1-1500-323-24-1
- NAVAIR 01-1A-505-1
- NAVSEA MIL-STD-763
- ARMY MICOM, Drawing 13210868
- NA 01-1A-505-1
- NA 01-1A-8
- TO 00-25-255-1
- TM 1-1500-323-24-2

Several Platform Specific TOs and TMs feature instructions and guidelines for Safe-T-Cable®. Consult the publications organization that supports your particular platform, or contact DMC for further information.

## National Stock Number Listing (NSN)

The majority of Safe-T-Cable® Tools and Components that are specified in Military Technical Manuals and Standards are covered by NSNs. See pages 24 and 25 of this catalog or consult DMC for Details.



## SAE

SAE International (Society of Automotive Engineers) maintains and distributes the procurement and detail specifications that control the design, packaging, and performance requirements of Safe-T-Cable®. SAE Specifications are available on-line at [www.sae.org](http://www.sae.org), or at the following address:

SAE INTERNATIONAL  
 400 Commonwealth Drive  
 Warrendale, OH 15044  
 (724) 776-4841

The List of Safe-T-Cable® Specifications are the following:

- AS567 Safety Cable, Safety Wire, Key Washers, and Cotter Pins for Production Systems, General Practices for Use of
- AS3509 Cable, Safety, Kit, Nickel Alloy, UNS N06600
- AS3510 Cable, Safety, Kit, Corrosion and Heat Resistant Steel, UNS S32100
- AS3511 Cable, Safety, Kit, Corrosion Resistant Steel, UNS S30400
- AS3618 Cable, Safety, Ferrule, Elongated, Corrosion and Heat Resistant Steel, UNS S32100
- AS3619 Cable, Safety, Ferrule, Elongated, Nickel Alloy, UNS N06600
- AS3655 Cable, Safety, Kit, Corrosion Resistant Nickel Alloy, UNS N06625
- AS4536 Cable, Safety, Kit, Procurement Specification For Requirements and Use

Please contact DMC for further information on SAE Specifications, Publication Status, or Application References.

## NASA



The National Aeronautical and Space Administration, in cooperation with major contractors has developed several reports and standards involving the testing, selection, use, procurement, and application of Safe-T-Cable®. Two significant NASA funded documents are CR4473 – CONTRACTOR REPORT (Intersel 1992), and JA83-032A Teledyne Brown.

NASA Tech Briefs magazine has also recognized Safe-T-Cable® as a modern Space Program Technology on one or more occasions. Safe-T-Cable® is used on the Space Shuttle main orbiter engines, structure, and payload applications.

## FAA

Many FAA Approved 70-XX-XX Standard Documents are published and maintained by major engine, airframe, and component/subsystem manufacturers.

The FAA Approved Manual (supplied by the OEM) on the specific aircraft (or subsystem) will advise the operator/maintainer if Safe-T-Cable® is approved by the OEM on that aircraft/application. If it can not be determined from this, or other documentation, the operator/maintainer should contact the OEM assigned representative, and request information concerning the use of Safe-T-Cable® on that aircraft or subsystem.

## Industry Standards

Pratt & Whitney: PWA 316 (Safety Wire, Safety Cable and Cotter-pin Installation)

Rolls Royce: JES 138 (Locking devices and Practices)

GE Aircraft Engines: 70-11-01-400-005 (Standard Practices Manual)

Boeing: BAC 5018 (Installation of Safetying Devices)

## DMC Statement on Safety Cable (Safe-T-Cable®)

Daniels Manufacturing Corporation, "DMC" manufactures and sells safety cable in conformity with Society of Automotive Engineers Standard (SAE) Standard AS4536, AS3509, AS3510 and customer specifications.

The Federal Aviation Administration (FAA) classified safety cable to be a standard part by issuance of a letter on November 23, 1993. This letter, in its entirety, along with the Federal Aviation Regulations (FAR) of that date referred to therein appears on the DMC Web Site, and on pages 24 and 25 of this catalog. The third paragraph of that letter states:

Installation of AS3509, AS3510 and AS3511 safety cable on aircraft is governed by FAR § 43.13, Performance Rules (general). FAR § 43.13 (a) states in part: "Each person performing maintenance, alteration, or preventative maintenance on an aircraft, engine, propeller, or appliance shall use the methods, techniques and practices prescribed in the current manufacturer's maintenance manual or Instructions for Continued Airworthiness prepared by its manufacturer, or other methods, techniques, and practices acceptable to the Administrator..."

It is the responsibility of the installer of safety cable to determine where safety cable can or cannot be installed in accordance with FAA regulations, OEM Practice Standards, or Department of Defense (DOD) directives. Where authorization is required, the installer should contact the Equipment OEM for the necessary authorization.

**DMC IS NOT LIABLE FOR CONSEQUENTIAL OR SPECIAL DAMAGES OF ANY NATURE OR KIND RESULTING FROM INSTALLATION OF SAFETY CABLE IN VIOLATION OF FAA, OEM, AND/OR DOD DIRECTIVES AND REGULATIONS.**

Safety Cable is a time saving technology. Please feel free to contact DMC for recommendations concerning the appropriate type of safety cable to be used for installation on authorized applications.

The referenced FAA Letter, and copy of the referenced F.A.R. as of the date of the referenced letter, are shown on pages 24 and 25 of this catalog, and on the [www.dmctools.com](http://www.dmctools.com) website.

### MILITARY & OTHER

#### GOVERNMENT

#### ORGANIZATIONS

Aerospace Defense Security (ADS - UK)  
California Dept of Forestry  
City of Anaheim  
City of Los Angeles Police Department  
City of Tallahassee  
Federal Aviation Administration (FAA)  
Georgia Aviation Authority  
L.A. County Fire Department  
Manatee County Sheriff  
NASA  
NAVAIR  
NAVSEA  
NOAA  
Ohio DOT  
Pearl Harbor Naval Shipyard  
Portsmouth Naval Shipyard  
Port Authority of NY & NJ  
Port of Seattle  
Royal Air Force (UK)  
U.S. Air Force  
U.S. Air National Guard  
U.S. Army  
U.S. Coast Guard  
U.S. Marine Corp  
Utah DOT

### AIRCRAFT AND AIRCRAFT

#### ENGINE MANUFACTURERS

Aerospace Testing Alliance (ATA)  
Allison (Rolls Royce)  
American Eurocopter  
BAE Systems  
BAE Systems (Eurofighter)  
BAE Systems (Marine)  
BAE Systems (Nimrod)  
Bell Helicopter  
BF Goodrich Aerospace  
Boeing-Commercial  
Boeing-Military  
Boeing-Rocketdyne  
Boeing-Sea Launch  
Boeing-Space  
Bombardier Learjet  
Bombardier Regionals  
Bombardier Shorts  
Bombardier Transportation  
Cessna Aircraft  
Dassault Falcon  
Embraer  
Erickson Air-Crane  
Eurofighter GmbH  
GE Aircraft Engines  
GE Transportation Systems  
GE Power Systems  
Gulfstream Aerospace  
Hawker Beechcraft  
Honda Aircraft Co  
Honeywell Aero Engines  
L3 Aerospace Corp.  
L3 Vertex  
Learjet (Bombardier)  
Lockheed Aeronautical Co.  
Lockheed Missile & Space  
Lockheed Martin Corp.  
Lycoming Engines  
Mitsubishi  
Northrop Grumman  
Parker Aerospace  
Parker Hannifin  
Pratt & Whitney (USA)  
Pratt & Whitney (Canada)  
Raytheon Aircraft  
Rolls Royce  
Sikorsky Aircraft  
SNECMA America Engine  
Teledyne Continental Engine  
Terrafugia  
TurboMeca  
Williams International

### OEM, MRO, AND OTHER

#### INDUSTRY

AAR Aircraft Services  
Airoyal Company  
Air Tractor  
Algonquin Power Sanger  
Alliant Techsystems Inc  
Alpine Aerospace Corp.  
American Champion Aircraft  
American Wire Works, Inc  
Ametek Thermal Systems  
APPH  
Argo Tech  
Associated Aircraft Group  
Atlantic Aero  
Bath Iron Works  
British Airways Avionic Engineering  
Calpine Corporation  
Caterpillar  
CEF Industries, Inc  
CHC Helicopters  
CityJet  
Constellation Energy  
Dallas Airmotive  
Devonport Management Ltd  
Dillon Aero  
Dominion Virginia Power  
Dowty Propellers  
Dowty Propellers Repair & Overhaul  
Drake Air Inc.  
Dubai Natural Gas Co Ltd  
Duke Energy  
Duncan Aviation  
Dyncorp  
Embry Riddle University  
ExecuJet Aviation Group  
Exelon  
Flir Systems  
FlyBe Aviation Services  
Fountain Valley Power  
FPL Energy  
Garrett Aviation  
Gas Turbine Efficiency (GTE)  
General Atomic  
General Dynamics  
Electric Boat  
Goodrich Aerospace  
Goodrich Engine Controls  
Grand Canyon Helicopters  
Great Lakes Aviation  
Haas TCM  
Hamilton Sundstrand  
Harris Corporation  
Haskel International Inc  
Hartzell Engine Technologies  
Hawaii Electric Light Co  
Helicomb International  
Helicopter Support Inc  
Hispano-Suiza  
Hitachi Zosen Usa Ltd  
Honeywell (Allied Signal)  
Honeywell (Garrett)  
H & S Aviation  
IGE Energy Services  
Int'l Aero Engines (IAE)  
ITT Aerospace Controls  
Jet Aviation  
Johnson Aerospace Inc  
Kal Aviation, Inc  
Kaman Aerospace  
Kelly Aerospace  
Key Air Inc  
Keystone Helicopter  
Knolls Atomic Power Laboratory (KAPL)  
Kollsman Instrument Company  
Lararge Inc  
Lucas Aerospace  
Lufthansa Airmotive  
Marine Mechanical  
MAYO Clinic  
Messier Dowty  
Messier Services  
Midcoast Aviation  
Middle East Propulsion Co  
Midwest Aviation  
Mobile Aircraft Services

### Moog

Muirhead Aerospace  
National Grid Company  
National Oil Well Varco  
Newport News Shipbuilding  
North American Energy Svc  
NRG Energy  
Otto Instrument Services  
Pacific Gas Turbine Center  
Pall Aeropower  
Patriot Aviation Services  
Petroleum Helicopters  
Piedmont Aviation  
Purrolator Facet, Inc.  
Raytheon Systems  
REGA Swiss Air Ambulance  
Remote Imagery  
Rockwell Collins  
Rohr Industries  
Rosemount Aerospace Inc  
Ryanair  
Sargent Controls & Aerospace  
Selex Systems  
Sherwood Aviation  
Shorts Bros (Bombardier)  
Sierra Nevada Corp  
South Texas Electric Coop  
Space Exploration Tech (SpaceX)  
Standard Aero  
Summit Aviation  
Tag Aviation  
Team JAS  
Teledyne Brown Engineering  
Thomas Cook Aircraft Engineering  
Transcanada Turbines  
Turbine Fuel Systems  
Ultra Electronics PAS  
Walker Precision  
Ward Leonard Electric Company  
Woodward Aircraft Engine Services  
Woodward Governor  
Wyle Laboratories

### AIRLINES

Air Canada  
Air China  
Air France  
Air New Zealand  
Airtran Airways  
Air Wisconsin  
Alaska Airlines  
American Airlines  
Aero Contractors Inc  
ASA  
Atlantic Southeast Airlines  
bmi British Midland  
British Airways  
Bulgaria Air  
Chautauqua Airlines, Inc  
Com Air  
Continental Airlines  
Delta Airlines  
El Al Israel Airlines  
Emirates Airlines  
FedEX  
Frontier Airlines  
Iberia Airlines  
Icelandair  
Jet Airways India Ltd  
JetBlue  
Lufthansa  
Mesa Airlines  
Mesaba Airlines  
Northwest Airlines  
Oman Air  
Pinnacle Airlines  
PSA Airlines, Inc.  
Qatar Airways  
Royal Brunei Airlines  
Skywest Airlines  
Southwest Airlines  
Turkish Airlines Tech  
UPS International  
US Airways  
Virgin Atlantic Airways  
Westjet

# Safe-T-Cable® Part Numbering System

## DMC Part No. System

## SAE Part No. System

		C10-218 XX	
COMPONENTS		CONFIGURATION	
C = Kit (Cable & Ferrule)		BLANK = Standard	
A = Assemblies (Cable Only)		XX = Special* (Consult DMC)	
F = Ferrules Only		PKG. = One Part No. For Each 50-Piece Package	
		CABLE DIAMETER	LENGTH
MATERIAL		1 = .022 / .026	06 = 6"
08 = INCONEL 625		2 = .032 / .038	09 = 9"
09 = INCONEL 600		3 = .040 / .046	12 = 12"
10 = 321 CRES		9 = .062 / .072	15 = 15"
			18 = 18"
			21 = 21"
			24 = 24"

		AS3510-02 18K	
MATERIAL		CONFIGURATION	
AS3509 = INCONEL 600		K = Kit (Cable & Ferrule)	
AS3510 = 321 CRES		C = Cable Assembly (Cable Only)	
AS3511 = 304 CRES (Consult DMC)		F = Ferrule (Ferrule Only)	
AS3655 = INCONEL 625			
		CABLE DIAMETER	LENGTH
		01 = .022 / .026	06 = 6"
		02 = .032 / .038	09 = 9"
		03 = .040 / .046	12 = 12"
		04 = .062 / .072	15 = 15"
			18 = 18"
			21 = 21"
			24 = 24"

**OTHER SAE PART NUMBERS** – AS3618, AS3619 (Elongated Ferrules)

**\*SPECIAL CONFIGURATION** – Logo Stamp, Self-Looping Cable, etc. may require more than two characters. Consult DMC for details.

### COLOR CODE LABELS

Standard packaging defines size by a standard DMC color code to avoid mixing ferrules and cable:

.022 RED/PINK    .032 BLUE    .040 YELLOW    .062 GREEN

CABLE AND COMPONENT MATERIAL IS CALLED OUT ON THE PACKAGE LABELING.

## Length Options

6", 9", 12", 15", 18", 21" and 24" (Dimensions are in inches)

Longer lengths available on special order.

**NOTE:** 18" length is recommended, and the most common length specified.

### IMPORTANT INFORMATION:

**When considering the cable length, be sure to add the extra cable required to engage the tension mechanism in the application tool: Add 8 inches for a tool with a 3 inch nose, and 12 inches for a tool with a 7 inch nose.**

**FOR WARRANTY AND LIMITATION OF LIABILITY INFORMATION, SEE PAGE 25.**

## Material Options

AS3509 = AMS5687 (INCONEL 600)  
AS3510 = AMS5689 (321 CRES)

AS3655 = AMS5666 (INCONEL 625)  
CRES = Corrosion Resistant Stainless Steel

**NOTE:** 321 CRES is considered to be Standard in the Aerospace Industry (see next page for ordering information).

## Optional Kit Configurations

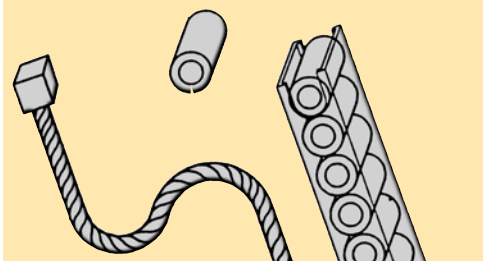
Safe-T-Cable® Kits are available in all combinations of standard cable/ferrules, branded cable, elongated ferrules and self-looping cable. Consult DMC for details.



# Safe-T-Cable® Kits (Cable Assembly & Ferrules)

## Safe-T-Cable® Kits

All Safe-T-Cable® Kits are packaged in quantities of 50 pieces per package.

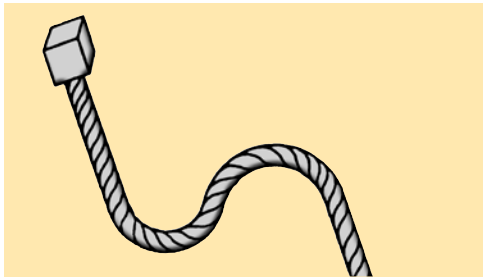


<sup>1</sup>Kit Part Number applies to one cable assembly and one ferrule. Minimum order is 50 pieces.

Order in multiples of 50 or add "PKG" to Part Number (shown in chart) when ordering a 50 piece bag of Safe-T-Cable®.

MATERIAL/PART NUMBER <sup>1</sup>			DIAMETER (INCHES) <sup>5</sup>	LENGTH
321 CRES	INCONEL 625	INCONEL 600		
C10-312	C08-312N	C09-312	.040	12"
C10-318	C08-318N	C09-318	.040	18"
C10-321	C08-321N	C09-321	.040	21"
C10-324	C08-324N	C09-324	.040	24"
C10-212	C08-212N	C09-212	.032	12"
C10-218	C08-218N	C09-218	.032	18"
C10-221	C08-221N	C09-221	.032	21"
C10-224	C08-224N	C09-224	.032	24"
C10-112	C08-112N	C09-112	.022	12"
C10-118	C08-118N	C09-118	.022	18"
C10-121	C08-121N	C09-121	.022	21"
C10-124	C08-124N	C09-124	.022	24"

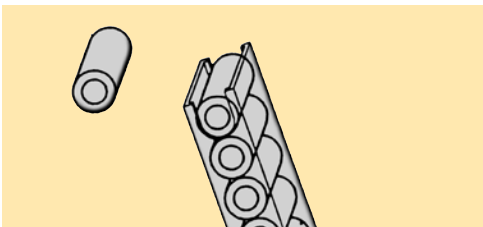
## Safe-T-Cable® Assemblies



<sup>2</sup>Assembly Part Number applies to one cable with end fitting attached. Minimum order is 50 pieces.

MATERIAL/PART NUMBER <sup>2</sup>			DIAMETER (INCHES) <sup>5</sup>	LENGTH
321 CRES	INCONEL 625	INCONEL 600		
A10-312	A08-312N	A09-312	.040	12"
A10-318	A08-318N	A09-318	.040	18"
A10-321	A08-321N	A09-321	.040	21"
A10-324	A08-324N	A09-324	.040	24"
A10-212	A08-212N	A09-212	.032	12"
A10-218	A08-218N	A09-218	.032	18"
A10-221	A08-221N	A09-221	.032	21"
A10-224	A08-224N	A09-224	.032	24"
A10-112	A08-112N	A09-112	.022	12"
A10-118	A08-118N	A09-118	.022	18"
A10-121	A08-121N	A09-121	.022	21"
A10-124	A08-124N	A09-124	.022	24"

## Safe-T-Cable® Ferrules



<sup>3</sup>Ferrule Part Number applies to one ferrule. Order in multiples of 50 or add "PKG" to Part Number when ordering a 50 piece cartridge of Safe-T-Cable® Ferrules.

<sup>4</sup>.022 elongated Ferrules are currently supplied in loose piece packaging (not in a cartridge).

CABLE DIAMETER (INCHES)	STANDARD <sup>3</sup>				LENGTH
	321 CRES	INCONEL 625	INCONEL 600	DIAMETER (INCHES) <sup>5</sup>	
.022	F10-1	F08-1N	F09-1	.090	.095 max
.032	F10-2	F08-2N	F09-2	.105	.064 max
.040	F10-3	F08-3N	F09-3	.105	.064 max
<b>ELONGATED FERRULES<sup>3</sup></b>					
.022	F10-08 <sup>4</sup>	F08-08N <sup>4</sup>	F09-08 <sup>4</sup>	.090	.185 max
.032	F10-04	F08-04N	F09-04	.105	.325 max
.040	F10-07	F08-07N	F09-07	.105	.325 max

<sup>5</sup> See page 17 for .062 Cable and Ferrule information.

**FOR WARRANTY AND LIMITATION OF LIABILITY INFORMATION, SEE PAGE 25.**

**NOTE:** Safe-T-Cable® material selection is the user's responsibility. It should be done with consideration to the environment where the Safe-T-Cable® is used. Generally speaking, the AS3510 Series is used in non-extreme conditions. AS3509 Series INCONEL 600 is specified in high temperature and non-magnetic required environments, and AS3655 Series INCONEL 625 is specified in high corrosion applications.

# Time-Saving Safe-T-Cable® Options

## Elongated Ferrules

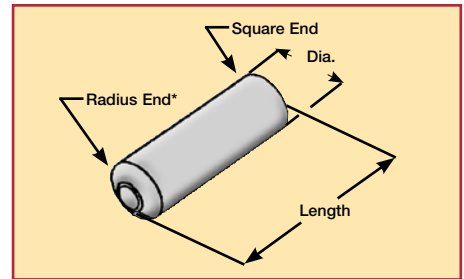
### For Low Profile Fastener Applications

Most Safe-T-Cable® installations can be made with standard components and application tools, however, there are conditions that require modification or alterations to the standard products. By addressing these exceptions, and extending the product lines to incorporate simple solutions to the difficult Safe-T-Cable® applications, DMC has established itself as the industry leader.

Fasteners that have limited clearance between the safety wire hole (less than .100 inch), and the surface of the component to which the fastener is attached, can present a challenge to the installation of Safe-T-Cable®. This is due to the clearance required by the application tool nose, adjacent to the fastener.

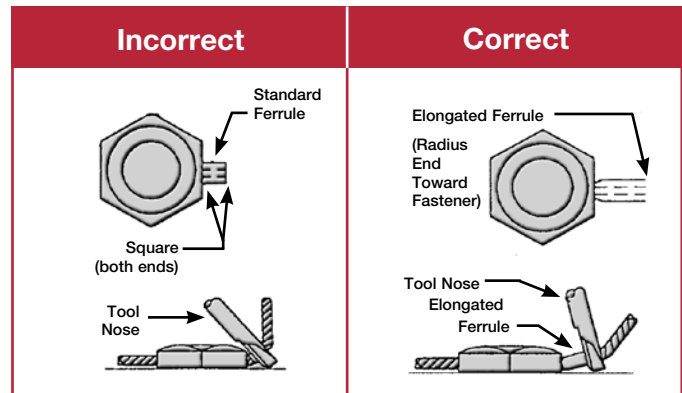


See previous page for elongated ferrule material, dimension and part number information.

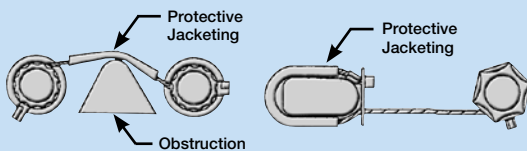


**A Special Elongated Ferrule** is available for those installations. The longer reach of the ferrule provides a stand off to the tool nose. Combine that with the radius on the end next to the fastener (radius not required on the F10-08 .022 elongated ferrules due to the small outside diameter). The radius allows the ferrule to be installed at an angle without loss of tension on the cable when the ferrule returns to the straight position.

\*Radius featured on .032 and .040 ferrule diameters only.



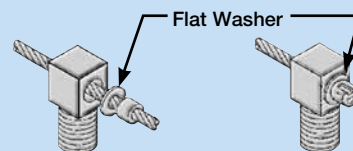
## Fiberglass Sleeving



**SAFE-T-CABLE® JACKETING FOR PROTECTION.** It is recommended that a tubular jacket be placed over Safe-T-Cable® when it is installed in an area where it will be in contact with obstructions or surfaces that may damage the Safe-T-Cable®. The tubular jacket material shall be capable of meeting the temperature range of the application. It shall also be resistant to oil, and chemical environments.

50-Foot Spool: Part No. SCTD010

## Filler Washer for .022, .032 and .040 Safe-T-Cable



Applications where Safe-T-Cable® is to be installed through a hole having a diameter greater than .095 inch (2.4mm), but less than .200 inch (5.08mm) can be accommodated by a filler washer.

**NOTE:** Compatible materials are required, and care must be taken to restrain the washer during removal/service operations.

Filler Washer • Material 321 CRES • Part No. FW10-1  
Material INCONEL 600 • Part No. FW09-1

# Time-Saving Safe-T-Cable® Options

## Self-Looping Safe-T-Cable®

It is DMC's mission to be responsive to the needs of Safe-T-Cable® users. One more example of that DMC responsiveness is the Self-Looping Safe-T-Cable®. There are many applications for Safety Wire where holes do not exist in a fastener or other part of the assembly. The common practice is to wrap the wire around a casting web, pin, or similar feature, and then anchor the other end to the fastener. The Self-Looping Safe-T-Cable® provides the user with a means of anchoring a threaded fastener to almost any structure.

The operator simply wraps the cable

through (or around) the structure, and back through the hole in the captive link at the head of the cable. The operator then pulls the slack out of the cable, threads it through the head of the fastener, and terminates it with a standard application tool.

Another type of application where the Self-Looping Safe-T-Cable® offers a clear advantage over Safety Wire is when it replaces Safety Wire on turnbuckles, castellated fittings, and other applications where holes are not provided at either end of the cable. In those cases, the cable is threaded around

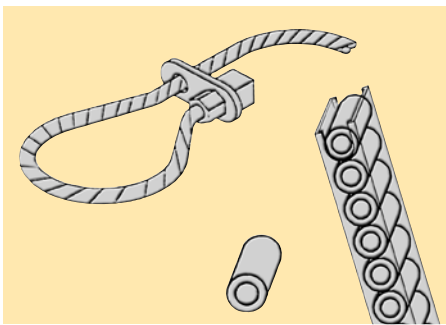


the fittings and terminated back at the hole in the captive link on the head of the Safe-T-Cable®.

**CAUTION:** Use good judgement in selecting a secure location to terminate Self-Looping Safe-T-Cable.

## Safe-T-Cable® Self-Looping Kit

With Standard Ferrule



Supplied 50 pieces per Package.

Note: Individual cable assemblies and special ferrule combinations are available.

MATERIAL/PART NUMBER*			DIAMETER (INCHES)	LENGTH** (SEE NOTE)
321 CRES	INCONEL 625	INCONEL 600		
C10-312JA	C08-312NJA	C09-312JA	.040	12"
C10-318JA	C08-318NJA	C09-318JA	.040	18"
C10-324JA	C08-324NJA	C09-324JA	.040	24"
C10-212JA	C08-212NJA	C09-212JA	.032	12"
C10-218JA	C08-218NJA	C09-218JA	.032	18"
C10-224JA	C08-224NJA	C09-224JA	.032	24"
C10-112JA	C08-112NJA	C09-112JA	.022	12"
C10-118JA	C08-118NJA	C09-118JA	.022	18"
C10-124JA	C08-124NJA	C09-124JA	.022	24"

\*Kit Part Number applies to one cable assembly and one ferrule. Add "PKG" to the end of the Part Number when ordering a 50 piece bag.

\*\*Other length combinations are available.

## Branded Safe-T-Cable®

Logo/Distinctive Mark Identification by the Factory

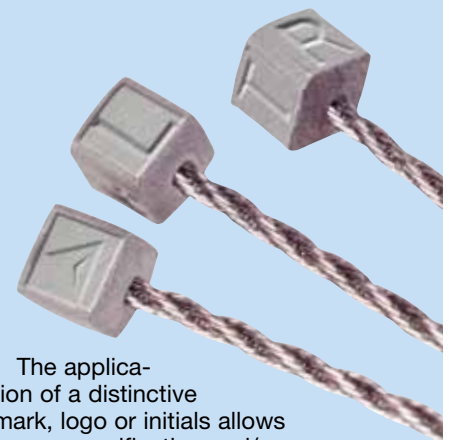
One more value-added service available from DMC to the users of Safe-T-Cable® is the application of a permanent mark (unique to one customer only) on the head of the Safe-T-Cable®. The distinctive brand on the cable end fitting, when installed on an engine, accessory, or other assembly, becomes a reliable identification flag that can be used to trace the final assembly to a date, location, or another significant purpose. The most common reasons that the DMC Safe-T-Cable® branding service has become very popular are the following:

### Warranty Traceability

Safe-T-Cable® with a corporate logo or other distinctive mark can be applied by the factory or authorized repair stations to limit warranty claims. Products returned for warranty repair can be easily inspected to verify that the factory applied logo or symbol is on the head of each Safe-T-Cable®.

### Service Location Verification

The exact location of the last service/repair of a product or component can be easily identified if your organization utilizes a well thought-out Safe-T-Cable® branding program.



The application of a distinctive mark, logo or initials allows for easy verification and/or routing of product for repair, rework, or other function.

# Safe-T-Cable® Application Tools

## It's a Matter of Choice...

Over 60 years of success in the design, production, and support of tooling for high-reliability applications in the aircraft and aerospace industry is the reason DMC was included in the development team for Safe-T-Cable®. The tooling, which was initially designed to meet the challenges of Safe-T-Cable® installation, has evolved into a product line that is flexible enough to meet the users' exact needs. It's your choice as to which model and accessories to specify, but understand that interchangeability, adjustability, and overall reliability is the basis of each application tool series.

### 1 Adjustable Tension Hand Tool Series

The most popular hand operated application tool for Safe-T-Cable® is the SCTR Series Adjustable Tension Tool. This tool series features a rotary tension mechanism which can be adjusted to precise cable tension requirements. This is a necessary control feature and very popular with all users. The tension will repeat at the setting which has been selected for reliable Safe-T-Cable® installations. Like all DMC Safe-T-Cable tools, this tool series features replaceable noses of various lengths (see chart on page 11).



### 2 Pre-Set Tension Hand Tool Series

In some factories where control of tool adjustments are not possible, where the skill level is minimal, or applications where a single-handed operation of the tool is desirable, the SCT Series Application Tool may be the best choice. All tools in this series feature a tension mechanism, which allows single-handed use of the tool (after the cable is threaded through and into the tool). Multiple actuations of the tool handle will draw the cable into the tool until all slack is removed from the cable.

When the tool senses the correct tension (pre-set at the factory), it will shift into the crimp-cut mode, and complete the installation of the Safe-T-Cable® on the next closure of the handle. It's as simple as that.



### 3 Pneumatic Application Tool Series

When ergonomics and production demands are critical issues, the DMC Adjustable Tension SCTPR (No. 3) and Pre-Set Tension SCTP (No. 4) Series Pneumatic Application Tool is a must. Safe-T-Cable® is threaded through the fasteners, into the ferrule, and into the tool in the same fashion as the manual tools. The SCTP tool automatically applies tension (adjustable), crimps and cuts flush in one actuation of the trigger. After the user applies tension with the tension wheel the SCTPR Tool automatically crimps and cuts the cable flush. These tools operate on standard shop air pressure, and may be suspended from a load balancer for an even greater improvement in ergonomics.




### 5 Battery Powered Tool Series

The DMC SCTE Series Battery Powered Safe-T-Cable® tool is an ergonomic alternative to the other Safe-T-Cable® Application Tools where a portable tool, without a hose or cord is required. The self contained hydraulic crimp system is reliable and the tool accommodates the same changeable noses and other accessories that are interchangeable with other DMC Safe-T-Cable® Application Tools.



# Safe-T-Cable® Part Numbers & Accessories

	DMC PART NUMBER		CABLE DIAMETER (INCHES)*	NOSE LENGTH (INCHES)	
<b>Adjustable Tension Hand Tool Series</b>  <b>①</b>	SCTR203		.022	3"	
	SCTR207		.022	7"	
	SCTR323		.032	3"	
	SCTR327		.032	7"	
	SCTR403		.040	3"	
	SCTR407		.040	7"	
<b>Pre-Set Tension Hand Tool Series</b>  <b>②</b>	SCT203		.022	3"	
	SCT207		.022	7"	
	SCT323		.032	3"	
	SCT327		.032	7"	
	SCT403		.040	3"	
	SCT407		.040	7"	
	<b>ADJUSTABLE</b>	<b>PRE-SET</b>			
<b>Pneumatic Application Tool Series</b>  <b>③ ④</b>	SCTPR203		SCTP203	.022	3"
	SCTPR207		SCTP207	.022	7"
	SCTPR323		SCTP323	.032	3"
	SCTPR327		SCTP327	.032	7"
	SCTPR403		SCTP403	.040	3"
	SCTPR407		SCTP407	.040	7"
<i>Note: SCTPR Series Tools are preferred where precise tension adjustments are needed.</i>					
<b>Battery Powered Application Tool Series</b>  <b>⑤</b>	SCTE203B		.022	3"	
	SCTE207B		.022	7"	
	SCTE323B		.032	3"	
	SCTE327B		.032	7"	
	SCTE403B		.040	3"	
	SCTE407B		.040	7"	
<b>Replacement Noses</b>  	SCTN20-3		.022	3"	
	SCTN20-5		.022	5"	
	SCTN20-7		.022	7"	
	SCTN32-3		.032	3"	
	SCTN32-5		.032	5"	
	SCTN32-7		.032	7"	
	SCTN40-3		.040	3"	
	SCTN40-5		.040	5"	
	SCTN40-7		.040	7"	

\*See page 17 for .062 Cable Tools and Noses.

## Special Tools and Accessories

DMC extends the capabilities of the Safe-T-Cable® Product Line by making available the following accessories and tools:



### SCT32084

Spanner Tool is for adjusting Hand & Pneumatic Safe-T-Cable® Application Tools (one spanner is supplied with each new tool).



### SCT32059SA

Nose Extender adds two inches in length. Can be used with any tool/nose combination.



### Replacement Tension Assembly

For use with SCTR Series tools only.  
**SCTR20TW-SA .022 Dia.**  
**SCTR32TW-SA .032 Dia.**  
**SCTR40TW-SA .040 Dia.**



### 45-6N

Cutter/Gripper for .022, .032 and .040 Safe-T-Cable® and Safety Wire

# Safe-T-Cable® Tool Performance Verification Equipment

Repeatability and traceability in the management of Safe-T-Cable® tools at all stages of their life cycle requires periodic testing and verification. DMC supplies all the equipment necessary to perform a quick reliable verification of the application tools either on-sight, or in the metrology lab. **Our objective has always been to provide a self-supporting system that does not require that tools be returned to the factory for simple testing and verification.**

## SCT-TB1 Torque Verification Block for .022", .032", and .040" Safe-T-Cable®



SCT-TB1R - Torque verification block configured for right-hand reading torque wrenches.



**SCTD0001**  
SCTD0001 Torque Wrench for .022, .032, and .040 Safe-T-Cable®.



**SCTD013**  
The SCTD013 Push Force Tester is used to apply 2 lbs of force to Safe-T-Cable installations when verifying cable tension on the Torque Verification Blocks (SCT-TB1, SCT-TB1R, and SCT-TB2)

Periodic verification of tool indenter and tensioning mechanism settings is done with the Safe-T-Cable® Torque Verification Block. Indenter setting should be verified periodically and must always be checked if the nose assembly has been removed or changed.

Safe-T-Cable® is installed on the HEX termination points and approximately 2 lb. force is applied to the cable with your finger (or the optional SCTD013) at the line marked "TEST AREA." If the cable does not touch the side or the bottom surface of the text area, then the cable tension is correct.

If the cable touches either the side or the bottom surface of the text area, remove the cable from the text block. Re-install another cable being careful to set the tool tension properly. If the cable still touches the side or bottom of the test area, then the tension setting of the tool is set too loosely

and needs to be adjusted as explained in the tool's instructions.

Place a calibrated 3/8 inch drive torque wrench (capable of indicating 30 in. lb to 110 in. lb.) into the square drive hole, orienting the Torque Verification Block on a flat surface, and apply specified force.

**NOTE:** Set the torque wrench according to the cable diameter being tested.



SAFE-T-CABLE® DIAMETER*	MINIMUM PULL-OFF LOAD	TORQUE WRENCH SETTING
.022"	30 lb.	30 in. lb.
.032"	70 lb.	70 in. lb.
.040"	110 lb.	110 in. lb.

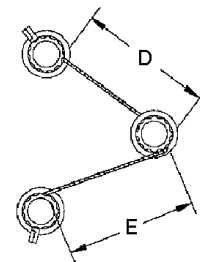
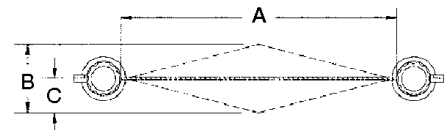
\*See page 17 for test equipment and information on .062 Safe-T-Cable .

TABLE 2 – FLEX LIMITS, Inch (mm)		
A	B	C
0.5 (12.7)	0.125 (3.18)	0.062 (1.59)
1.0 (25.4)	0.250 (6.35)	0.125 (3.18)
2.0 (50.8)	0.375 (9.52)	0.188 (4.76)
3.0 (76.2)	0.375 (9.52)	0.188 (4.76)
4.0 (101.6)	0.500 (12.70)	0.250 (6.35)
5.0 (127.0)	0.500 (12.70)	0.250 (6.35)
6.0 (152.4)	0.625 (15.88)	0.312 (7.94)



Safe-T-Cable® should remain in place during application of the measured force. If the ferrule pops off the cable, the crimp is unacceptable and the tool indenter should be adjusted. If the ferrule remains attached to the cable, recheck the cable tension as before. If the cable now touches either the side or the bottom surface of the Torque Verification Block, the crimp is unacceptable and the tool indenter should be adjusted.

Refer to Safe-T-Cable® application tool instructions, the Safe-T-Cable Training Manual, or contact DMC for more specific information on Tool Performance Verification.



FOR THREE BOLT PATTERNS  
A = D + E

# Safe-T-Cable® Tool Performance Verification Equipment



## Advanced Technology for Safe-T-Cable® Application Tool Testing

The SCT-TB4 Safe-T-Cable® Electronic Verification Tester is a complete diagnostic center for Safe-T-Cable® application tools. The SCT-TB4 is the first system approach tester for optimum Safe-T-Cable® installation performance. It combines the simple principals of the DMC Safe-T-Cable® Torque Verification Block (SCT-TB1) and the reliable circuitry of the Alphatron "HPT" series digital electronic pull tester.



This one tester will provide all the information that previously required two separate testers, and increased consumption of Safe-T-Cable® for verification of application tools. A single installed cable assembly can first be tested for minimum load – hold (flex limit test), and then be tested to destruct load (optimum tool performance). The SCT-TB4 Tester will also provide applied tension and residual tension data for engineering study and employee training purposes.

The SCT-TB4 tester is designed and packaged to survive in a shop environment, and the self contained, battery powered, design allows the user to perform tests in all areas of the shop and field support activities.

The SCT-TB4 Tester is a cost-effective quality assurance tool in most factory and maintenance applications where Safe-T-Cable® is used.



- All DMC testers have a built-in calibration test
- SPC compatible
- Traceable to NIST
- Factory calibration and support
- Rugged design, and custom carry case included
- One sample testing to the requirements of AS4536 and other standards
- Improves tool control and calibration operations

## MPT-250B-SC Motorized Pull Tester



The MPT-250B-SC Motorized Pull Tester is designed to perform pull-off testing of .020, .032 and .040 diameter sizes of Safe-T-Cable® to verify compliance requirements of SAE Aerospace Standard AS4536.

### STANDARD FEATURES

- Capacity: 5-250 lb, 22-1112 N, 2-113 Kg
- Accuracy:  $\pm$  (0.5 %)
- Digital Display with Peak Hold
- 1" - 10" Per minute Selectable Rate of Pull in ten 1"/min increments
- Auto Stop on Cable Break
- Auto Stop Enable/Disable Switch
- Auto Return to Start Position in Reset Mode
- Factory Set Overload Protection
- Easy Setup and Operation
- Compact Size

### DMC Offers Complete Tool And Parts Kits To Support Your

### Safe-T-Cable® Applications.

DMC is well known throughout the aerospace industry for the quality and capability of the Tool Kits that we manufacture. The packaging materials (case, inserts, and instructions) are manufactured to specifically meet the most demanding handling conditions.

FOD (Foreign Object Damage) is always a concern when workers are required to use tools and small components in or around an aircraft. The DMC Safe-T-Cable® tool kits are designed to minimize that concern. The “shadowing” principal is a proven concept for Tool/parts control.

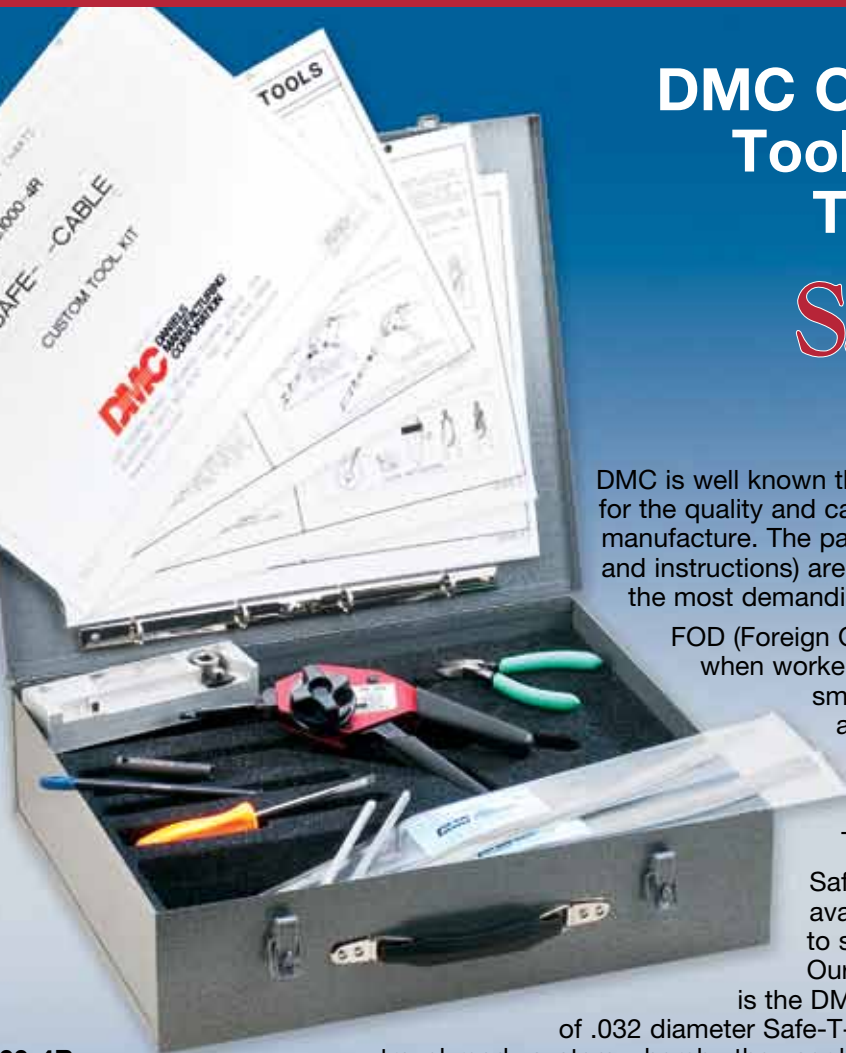
Safe-T-Cable® Tool and Parts Kits are available in a variety of configurations to support your specific requirements. Our most requested Tool & Parts Kit

is the DMC1000-4R due to the popularity of .032 diameter Safe-T-Cable®, and the demand for a travel-ready system whereby the user has Tools, Verification Equipment, Accessories, a supply of Cable/Ferrules, and the Instructions all in one package.

Other Kits are available to support your particular needs. The most popular selections are listed on the following page.

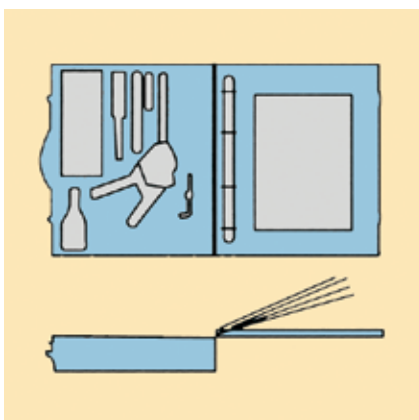
If you have specific needs that cannot be covered by the Tool Kits that are described here, please call a DMC customer service representative for information on a Kit that will more appropriately meet your requirements.

**DMC1000-4R**



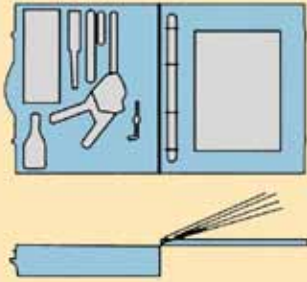
### DMC1000-4R

### .032 Safe-T-Cable® Tool and Parts Kit



PART NUMBER	QUANTITY	DESCRIPTION
SCTR323	1	Safe-T-Cable® Tool with 3" Nose Attached (.032)
SCTN32-7	1	7" Nose Assembly (.032)
C10-218	100	Safe-T-Cable® (.032 x 18")
SCT-TB1	1	Safe-T-Cable® Torque Verification Block
4-1501	1	9/64" Hex Wrench
SDD440	1	Screwdriver
45-6N	1	Diagonal Cutter/Gripper
SCT32084	1	Spanner Tool

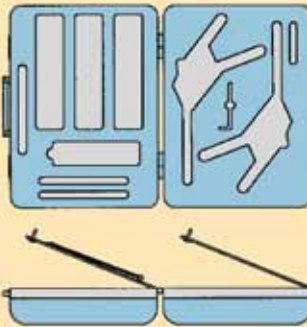




### DMC1001-7R

### .022 Safe-T-Cable® Tool and Parts Kit

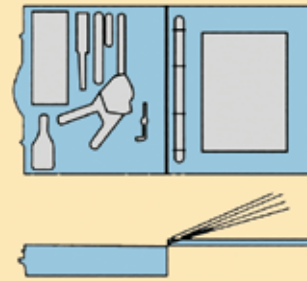
PART NUMBER	QUANTITY	DESCRIPTION
SCTR203	1	Safe-T-Cable® Tool with 3" Nose Attached (.022)
SCTN20-7	1	7" Nose Assembly (.022)
C10-118	100	Safe-T-Cable® (.022 x 18")
SCT-TB1	1	Safe-T-Cable® Torque Verification Block
4-1501	1	9/64" Hex Wrench
SDD440	1	Screwdriver
45-6N	1	Diagonal Cutter/Gripper
SCT32084	1	Spanner Tool



### DMC1000-20R

### .022 & .032 Safe-T-Cable® Tool and Parts Kit

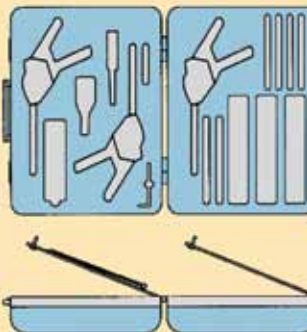
PART NUMBER	QUANTITY	DESCRIPTION
SCTR323	1	Safe-T-Cable® Tool with 3" Nose Attached (.032)
SCTR203	1	Safe-T-Cable® Tool with 3" Nose Attached (.022)
SCTN32-7	1	7" Nose Assembly (.032)
SCTN20-7	1	7" Nose Assembly (.022)
C10-218	100	Safe-T-Cable® (.032 x 18")
C10-118	100	Safe-T-Cable® (.022 x 18")
C10-218JA	50	Self-Looping Safe-T-Cable® (.032 x 18")
SCT-TB1	1	Safe-T-Cable® Torque Verification Block
4-1501	1	9/64" Hex Wrench
F10-04	50	Elongated Ferrules (.032)
SCT32084	1	Spanner Tool
SDD440	1	Screwdriver
45-6N	1	Diagonal Cutter Gripper



### DMC1000-11R

### .040 Safe-T-Cable® Tool and Parts Kit

PART NUMBER	QUANTITY	DESCRIPTION
SCTR407	1	Safe-T-Cable® Tool with 7" Nose Attached (.040)
C10-318	100	Safe-T-Cable® (.040 x 18")
SCT-TB1	1	Safe-T-Cable® Torque Verification Block
4-1501	1	9/64" Hex Wrench
SDD440	1	Screwdriver
45-6N	1	Diagonal Cutter/Gripper
SCT32084	1	Spanner Tool

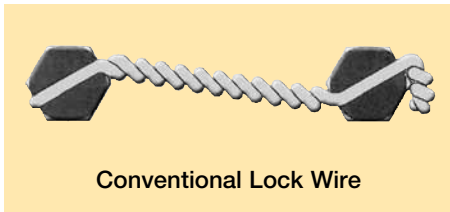


### DMC1007-28R

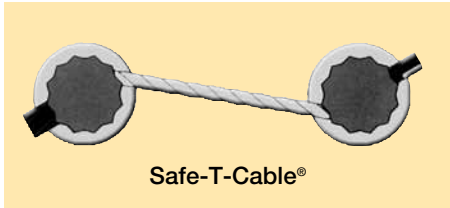
### Master Kit (.022, .032, and .040 Safe-T-Cable®)

PART NUMBER	QUANTITY	DESCRIPTION
SCTR203	1	Safe-T-Cable® Tool with 3" Nose Attached (.022)
SCTR323	1	Safe-T-Cable® Tool with 3" Nose Attached (.032)
SCTR403	1	Safe-T-Cable® Tool with 3" Nose Attached (.040)
SCTN20-7	1	7" Nose Assembly (.022)
SCTN32-7	1	7" Nose Assembly (.032)
SCTN32-7	1	7" Nose Assembly (.040)
SCT-TB1	1	Torque Verification Block
SCT32084	1	Spanner Tool
SDD440	1	Screwdriver
4-1501	1	9/64" Hex Wrench
45-6N	1	Diagonal Cutter/Gripper
C10-118	100	Safe-T-Cable® (.022 x 18")
C10-118JA	50	Self-Looping Safe-T-Cable® (.022)
C10-218	100	Safe-T-Cable® (.032)
C10-218JA	50	Self-Looping Safe-T-Cable® (.032)
C10-318	100	Safe-T-Cable® (.040)
C10-318JA	50	Self-Looping Safe-T-Cable® (.040)
F10-04	50	Elongated Ferrules (.032)
F10-07	50	Elongated Ferrules (.040)
F10-08	50	Elongated Ferrules (.022)

# .062 Safe-T-Cable® (Locking Cable)



Conventional Lock Wire



Safe-T-Cable®

An urgent need for a fast reliable fastener security system for the Nuclear Power Industry resulted in the further expansion of Safe-T-Cable® (Locking Cable) by DMC. Working with a major contractor to NAVSEA and commercial power organizations, DMC developed and certified a .062 diameter Safe-T-Cable® for use onboard nuclear submarines, and carriers. The .062 diameter Safe-T-Cable® (Locking Cable) was later tested and certified for use by the commercial power industry, aircraft applications, and industrial use. The practice of twisting Lock Wire onto fasteners and threaded assemblies is a tedious task, which requires skill and time. Lock Wire measuring .062 diameter is anything but "user friendly". Safe-T-Cable® (Locking Cable) allows maintenance and other operations to be performed in the minimum time, in tight access areas, with limited inspection, and with no rework due to faulty lockwiring. Also, handling the tool and materials for Safe-T-Cable® (Locking Cable) will not damage special gloves or protective clothing.

.032 and .062 diameter Safe-T-Cable® (Locking Cable) is recognized and defined in MIL-STD-763 (G Revision).

**Construction:** The standard .062 diameter Safe-T-Cable® (Locking Cable) is 24 inches in length, and measures .062 min./ .072 inch max. diameter. The cable is comprised of 7 strands of 19 wires each for maximum strength and flexibility. The factory-applied end fitting (square) measures approximately .155 inch across the flats, and the outside diameter of the user applied ferrule measures .150 inch. The minimum pull-off load of the ferrule after crimping is 280 pounds (per MIL-STD 763). Product samples, application information, and technical data may be obtained by contacting DMC.

Two application tools are available from DMC, and two installation kits are also available.

**The Hydraulic Application Tool (part number SCTH625)** utilizes a lightweight hand actuated hydraulic pump to develop the force required to crimp and cut the .062 diameter Safe-T-Cable® (Locking Cable).

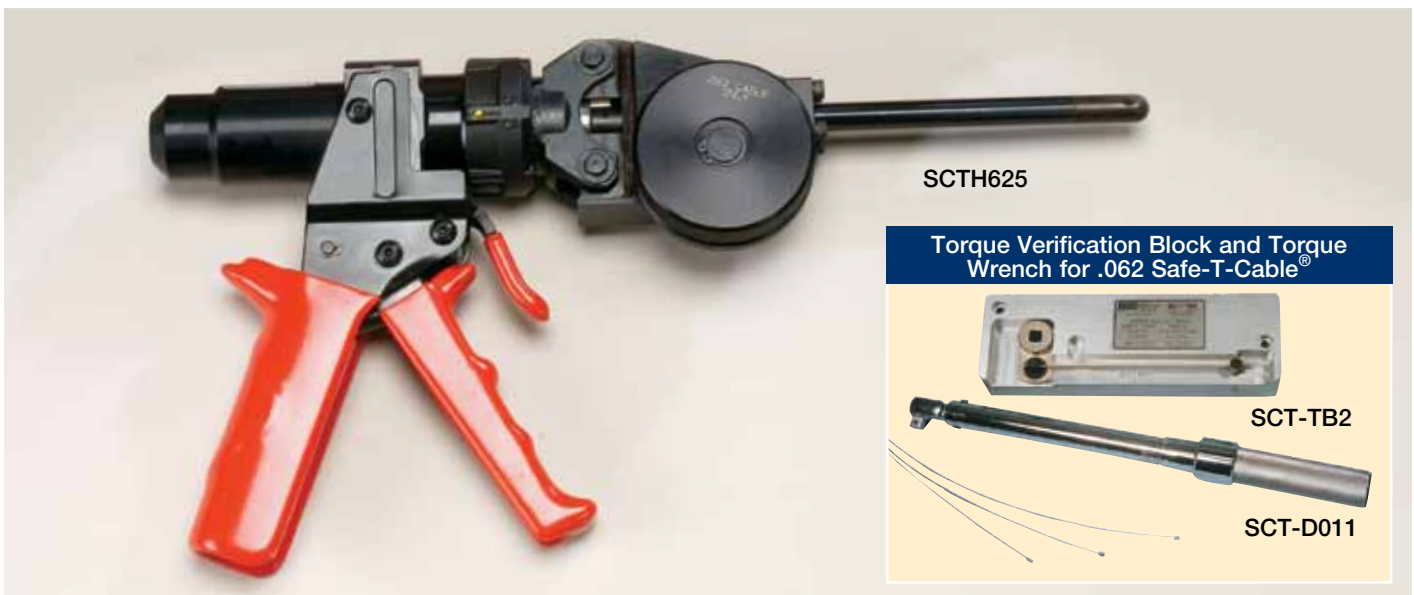
The tool crimps and cuts the assembly flush to the ferrule by multiple actuation of a single handle.

**The Battery Powered Hydraulic Application Tool (part number SCTE625B)** provides the same reliable Safe-T-Cable® termination by pressing a trigger. This tool is lightweight and self-contained. The Lithium Ion battery is rechargeable (charger supplied).

*Other Nose Length Tools Are Available (See Chart Next Page)*



SCTE625B



SCTH625

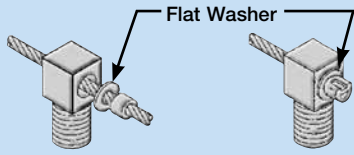
Torque Verification Block and Torque Wrench for .062 Safe-T-Cable®

SCT-TB2

SCT-D011

# .062 Safe-T-Cable® (Locking Cable)

## Filler Washer



Flat Washer  
Safe-T-Cable® Installation

Applications where Safe-T-Cable® is to be installed through a hole having a diameter greater than .145 inch, (3.6mm), but less than .300 inch (7.6mm) can be accommodated by a filler washer.

**NOTE: Compatible materials are required, and care must be taken to restrain the washer during removal/service operations.**

**Filler Washer  
Material 321 CRES  
Part No. FW10-9**

<b>.062 CABLE KITS* (ONE CABLE AND ONE FERRULE)</b>			
LENGTH	321 CRES	INCONEL 625	INCONEL 600
18"	C10-918	Consult DMC	C09-918
24"	C10-924	Consult DMC	C09-924
30"	C10-930	Consult DMC	C09-930
<b>.062 CABLE ASSEMBLY* (CABLE ONLY – NO FERRULE)</b>			
18"	A10-918	Consult DMC	A09-918
24"	A10-924	Consult DMC	A09-924
30"	A10-930	Consult DMC	A09-930
<b>.062 FERRULES* (STANDARD AND ELONGATED)</b>			
Standard	F10-9	Consult DMC	F09-9
Elongated	F10-10	Consult DMC	Consult DMC
<b>.062 TOOLS AND ACCESSORIES</b>			
SCTH625	Manual Hydraulic Application Tool with 5" Nose		
SCTH629	Manual Hydraulic Application Tool with 9" Nose		
SCTE625B	Battery Powered Application Tool with 5" Nose		
SCTE629B	Battery Powered Application Tool with 9" Nose		
SCTHN62-5	Replacement Nose – 5" Length		
SCTHN62-9	Replacement Nose – 9" Length		
SCT-TB2	Torque Verification Block for .062 Safe-T-Cable®		
SCTD011	Torque Wrench – 100 to 750 In. Lb. Range		
SCTD015	Cable Cutter/Gripper		
SCTD012	Retaining Ring Plier		

\*Supplied in packages of 50 pieces.

\*\*Add "PKG" to part number when ordering a 50 piece bag of cable and/or ferrules.

**OPTIONAL  
CONFIGURATION  
FLANGE FITTINGS  
FOR FASTENERS  
WITH  
HOLES UP TO  
.315" (8 MM) DIAMETER**



Crimp Ferrule

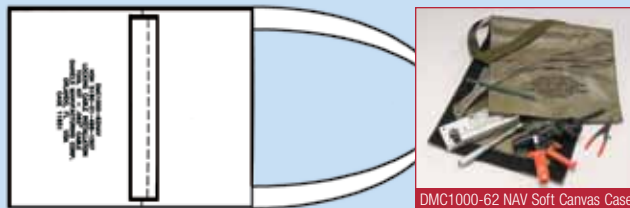


Cable End Fitting

*Consult DMC for  
Part Numbers  
and Availability*

## .062 Safe-T-Cable® Tool & Parts Kits

### DMC1000-62NAV Soft Case Support Kit

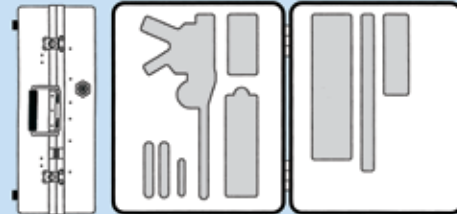


DMC1000-62 NAV Soft Canvas Case

#### PARTS LIST

PART NUMBER	QUANTITY	DESCRIPTION
SCTH625	1	.062 Safe-T-Cable® Hydraulic Tool with 5" Nose
SCTHN62-9	1	.062 Nose Assembly 9" Long
A10-924	250	Safe-T-Cable® .062 x 24
F10-9	250	Safe-T-Cable® Ferrule, .062
SCTD015	1	.062 Diagonal Cutter
4-1136	1	3/32 Hex Wrench
SCTD012	1	Retaining Ring Pliers
565B	1	Drive Punch
SCTD011	1	Torque Wrench 100–750 In. lb
SCT-TB2	1	Torque Verification Block
—	1	Handbook (Instructions)

### DMC1000-625 Hard Case Support Kit



#### PARTS LIST

PART NUMBER	QUANTITY	DESCRIPTION
SCTH625	1	.062 Safe-T-Cable® Hydraulic Tool with 5" Nose
C10-924	100	Safe-T-Cable® 321 CRES .062 x 24"
SCT-TB2	1	Safe-T-Cable® Torque Verification Block
SCTD015	1	Diagonal Cutter
SCT32084	1	Spanner Tool
SCTD011	1	Torque Wrench 100–750 In. lb
SCTD012	1	Retaining Ring Pliers
4-1501	1	9/64" Hex Wrench
565B	1	Drive Punch

# Installation Practices Guide

Safe-T-Cable® Application/Installation information which appears on these pages was adapted from a U.S. Military Handbook. It is intended for reference only. It is the responsibility of the user to verify and confirm that the installation of Safe-T-Cable® is safe and appropriate for the application.

## 1. Safe-T-Cable®

1.1. General Instructions for the selection of Safe-T-Cable®. The selection of materials shall be in accordance with AS4536 (SAE), available from SAE International, 400 Commonwealth Avenue, Warrendale, PA 15096-0001, and shall be in accordance with the service limitations outlined herein.

### NOTE

*Minimize mixing of safety wire and Safe-T-Cable®.*

1.1.1. AS3510 series (UNS S32100 CRES) Safe-T-Cable® shall be selected for general purpose use on all applications up to 800° F.

1.1.2. AS3509 series (UNS N6600 Nickel Alloy) Safe-T-Cable® shall be selected for applications where temperature range is between 800° F and 1500° F or electrical related applications where magnetic materials cannot be used.

1.1.3. AS3655 Series (UNS N0625) Safe-T-Cable® shall be selected for applications where corrosion resistance is required. This includes fasteners in direct contact with salt water or chemicals.

1.1.4. Only Safe-T-Cable® and ferrules supplied by a manufacturer that meets all the requirements of AS4536 shall be allowed.

1.1.5. Safe-T-Cable® shall not be used for any shear, or break away applications.

1.1.6. Safe-T-Cable® shall be installed with a calibrated tool which is supplied by the Safe-T-Cable® manufacturer for the purpose of applying a predetermined cable tension, crimping the ferrule, and cutting the excess cable without allowing tension to be lost.

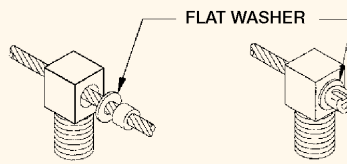
1.2 The size of Safe-T-Cable® shall be in accordance with the following requirements:

1.2.1. 0.022 inch diameter Safe-T-Cable® is intended for use on parts having a nominal hole diameter of 0.045 inch (1.14 mm) or smaller.

1.2.2 0.032 inch diameter Safe-T-Cable® is intended for use on parts having a nominal hole diameter of 0.075 inch (1.91 mm) or smaller.

1.2.3. 0.040 inch diameter Safe-T-Cable® is intended for use on parts having a nominal hole diameter of 0.095 inch (2.41 mm) or smaller.

1.2.4. The specified length of the cable shall be selected to accommodate the span between fasteners added to the length of cable required to correctly engage the application tool.



**FIGURE 1: Flat Washer Safe-T-Cable® Installation**

1.2.5. Applications where Safe-T-Cable® is to be installed through a hole having a nominal diameter of greater than .095 inch (2.41 mm), but less than .200 inch (5.08 mm) shall require a flat washer (same material composition as the Safe-T-Cable®) which is supplied by the Safe-T-Cable® manufacturer for this purpose, and shall be used as shown in Figure 1.

1.2.6. Safe-T-Cable® shall be installed with an application tool which has been calibrated to meet the performance requirements of AS4536 (SAE) and this manual.

1.3. Safe-T-Cable® Installation. Safe-T-Cable® may be used as a substitute for Safety Wire to prevent loosening during service. Threaded parts, such as drilled-head bolts, fillister head screws, turnbuckles, thumbscrews, hose fittings and electrical connectors, plugs, caps, and similar items are within the scope of the Safe-T-Cable® application. The following rules shall apply when using Safe-T-Cable®.

### NOTE

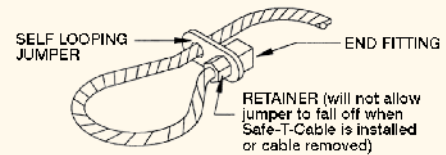
*Routing of Safe-T-Cable® may vary from that of Safety Wire in order to achieve a proper installation.*

1.3.1. When Safe-T-Cable® is being substituted for Safety Wire in an existing installation (maintenance, rework, etc.), equivalent diameter Safe-T-Cable® to that of the Safety Wire shall be selected for use, providing that selection criteria for Safe-T-Cable® as defined in the section 1.1 (General Instructions) are met.

1.3.2. Adjacent Units: Safe-T-Cable® shall be installed in such a manner that any tendency for a fastener to loosen will be counteracted by an additional tension on the cable. Safe-T-Cable® shall be threaded through the fasteners in such a way as to produce installed Safe-T-Cable® with either positive or neutral pull.

1.3.3. Maximum Span: The maximum span of Safe-T-Cable® between two termination points shall be 6 inches (152.4 mm) unless otherwise specified.

1.3.4. Installing Defects: Any cable defect (nick, fray, kink, or any other mutilation of the Safe-T-Cable®) found prior to, during, or subsequent to installation, is not acceptable.

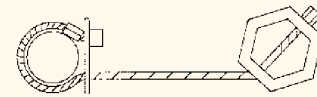


**FIGURE 2: Self Looping Safe-T-Cable®**

### NOTE

*Avoid kinks or sharp bends while handling and threading Safe-T-Cable®.*

1.3.5. Installing Holes: Safe-T-Cable® must be installed through the holes intended for this purpose in the part being secured, or through the holes provided in a self looping device (Figure 2) secured to the Safe-T-Cable® by the Safe-T-Cable® manufacturer. In applications where holes are not provided for Safe-T-Cable® in the component to which it is attached the self looping Safe-T-Cable® may be used in a manner like, or similar to Figure 3.



**FIGURE 3: Self Looping Safe-T-Cable® Anchored to a PIN Assembly**

1.3.6. Safe-T-Cable®/Ferrule Reuse: Safe-T-Cable® and ferrule shall be new upon each application. Reuse is not allowed.

1.3.7. Installation: Various examples of Safe-T-Cable® installation are shown in this section. All possible combinations and applications are not shown. Unless otherwise specified in the application engineering drawing, Safe-T-Cable® shall be installed in two or three bolt patterns with two bolt patterns being the preferred method where an even number of fasteners are to be secured. The installer must adhere to the basic rules outlined in this manual.

1.3.8. Hose Fittings and Electrical Connector Requirements: Hose Fittings and electrical coupling nuts shall have Safe-T-Cable® installed in the same manner as tube coupling nuts.

1.3.9. Excess Cable: After installing Safe-T-Cable®, excess cable from the crimped ferrule shall be cut by the installation tool. The maximum allowable length of cable extending beyond the ferrule shall be .031 inch (0.79 mm).

1.3.10. Crimping Requirements (Pull-Off Load, refer to Table 1): Safe-T-Cable® shall be installed with the Safe-T-Cable® manufacturers recommended tool, which has been tested and calibrated in accordance with procedures specified in this manual.

**TABLE 1: Safe-T-Cable® Minimum Crimp Requirements (Pull-Off Load)**

Nominal Cable Diameter inch (mm)	Safe-T-Cable® Construction	Minimum Pull-Off Load lbf (N)
.022 (0.51)	1 x 7	30 (133.4)
.032 (0.81)	3 x 7	70 (311.4)
.040 (1.02)	7 x 7	110 (489.3)
.062 (1.57)	7 x 19	280 (1245.4)

1.3.11. Hole Alignment: Undertorquing or overtorquing to obtain proper alignment of the holes is not permitted. Apply recommended torque values to parts to be secured, and alignment of holes shall be evaluated before attempting to proceed with Safe-T-Cable® installation.

**CAUTION**

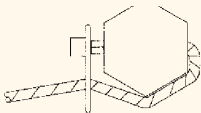
The maximum bend exit limit of Safe-T-Cable®, when applied to a threaded fastener head, shall be 135°.

This does not apply to hose fittings, electrical connector coupling mechanisms, turnbuckles, and similar applications where the Safe-T-Cable® is constrained by the shape of the component being secured.

1.3.12. In applications where Safe-T-Cable® shall be required to exceed the 135° maximum bend exit limit in order to achieve neutral to positive pull on a threaded fastener head, a self looping device which is secured to the Safe-T-Cable® by the Safe-T-Cable® manufacturer may be used to obtain a secured installation as shown (Figure 4).

**CAUTION**

This method should only be used in applications where the Safe-T-Cable® can not “flip” over the corner or over the head of the fastener being secured.



**FIGURE 4: Self Looping Safe-T-Cable® in High Bend Exit Application**

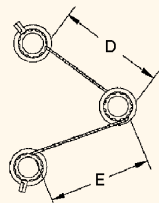
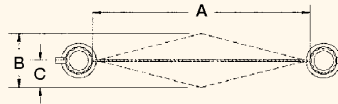
1.3.13. Cable Flex Limits: After installing Safe-T-Cable®, the maximum flex between termination points shall be no greater than that specified in the Cable Flex Limit Table (Table 2).

**NOTE**

Light finger pressure of approximately 2 pounds shall be applied at mid-span when inspecting total flex limit of installed Safe-T-Cable®.

**TABLE 2 – FLEX LIMITS, Inch (mm)**

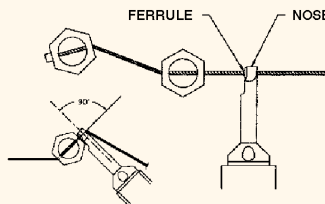
A	B	C
0.5 (12.7)	0.125 (3.18)	0.062 (1.59)
1.0 (25.4)	0.250 (6.35)	0.125 (3.18)
2.0 (50.8)	0.375 (9.52)	0.188 (4.76)
3.0 (76.2)	0.375 (9.52)	0.188 (4.76)
4.0 (101.6)	0.500 (12.70)	0.250 (6.35)
5.0 (127.0)	0.500 (12.70)	0.250 (6.35)
6.0 (152.4)	0.625 (15.88)	0.312 (7.94)



FOR THREE BOLT PATTERNS  
A = D + E

**FIGURE 5: Safe-T-Cable® Flex Limits**

It is important to hold the tool as steady and perpendicular to the fastener as possible during the crimp/cut cycle in order to maintain consistent tensioning of the cable after the tool is removed.

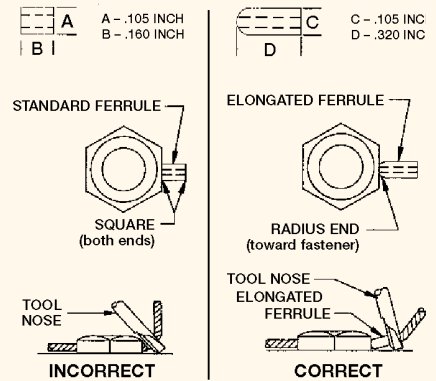


**FIGURE 6: Correct Application of Safe-T-Cable®**

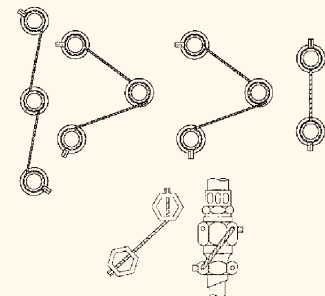
1.4. Elongated Ferrules: Ferrules of extra length, having a radius\* at one end and a straight surface at the other end, may be used in applications which restrict the clearance for the installation tool nose to be placed in correct alignment with the fastener (such as low profile fastener heads, recess locations, or obstructions by structures or installed components).  
\*Radius not required for .022 Elongated Ferrules

**NOTE**

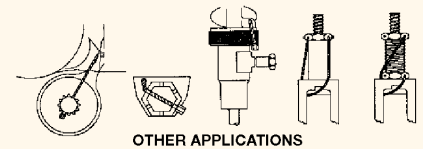
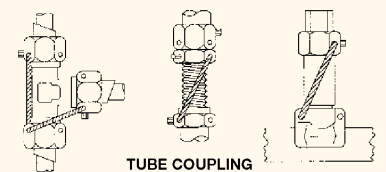
Always install elongated ferrules with the radius end toward the fastener, and the straight end in the tool crimp cavity. Double check cable tension between fasteners after removal of application tool.



**FIGURE 7: Low Profile Application For .022, .032 and .040 Inch Safe-T-Cable®**

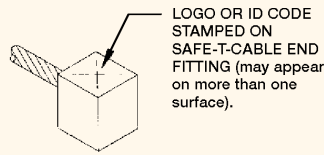


**FIGURE 8: Standard Hardware**



**FIGURE 9: Examples of Installed Safe-T-Cable®**

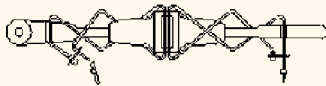
1.5. Safe-T-Cable® identification stamp. In applications where the user requires a logo or ID code to be a permanent part of the Safe-T-Cable® installation (for warranty or traceability), it shall be applied by the Safe-T-Cable® manufacturer to one or more surfaces of the square end fitting of the Safe-T-Cable®. Only impression stamping is permitted, no paint, ink, or labels are acceptable (Figure 10).



**FIGURE 10: Safe-T-Cable® Identification Stamp**

1.6 Safe-T-Cable® on Turnbuckles: The standard procedure for securing turnbuckles with Safe-T-Cable® is shown in Figure 11 and 12.

1.6.1 A self looping cable is threaded through the turnbuckle. One end shall be wrapped in one direction around the turnbuckle. The Safe-T-Cable® is then threaded through the hole in the self-looping jumper, and terminated with the appropriate application tool.



**FIGURE 11: Routing of Safe-T-Cable® on Turnbuckles**

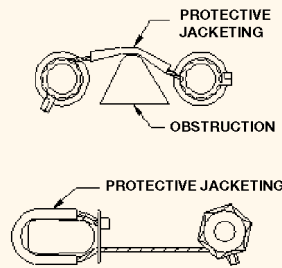


**FIGURE 12: Example of Final Safe-T-Cable® Turnbuckle Installation**

**NOTE**

Safe-T-Cable® diameter selection for turnbuckle applications: .032 inch (diameter) cable shall be used on assemblies where cable diameter in 1/16 inch (1.6 mm) or smaller, and .040 inch diameter cable or greater shall be used on turnbuckle cable diameters greater than 1/16 inch.

1.7 Safe-T-Cable® Jacketing for Protection: It is recommended to use a tubular jacket over Safe-T-Cable® when it is installed in a location where it is in contact with (or may contact) surfaces which may damage the cable (shown in Figure 13). The tubular jacket material shall be capable of meeting the temperature range of the application and shall be resistant to oil and chemical environments.



**FIGURE 13: Safe-T-Cable® Jacketing for Protection**

**2. Safe-T-Cable® Application Tools**

2.1 Procedures. When Safe-T-Cable® is used, the following basics apply for the application tools and calibration equipment.

2.1.1. Minimize mixing of safety wire and Safe-T-Cable®.

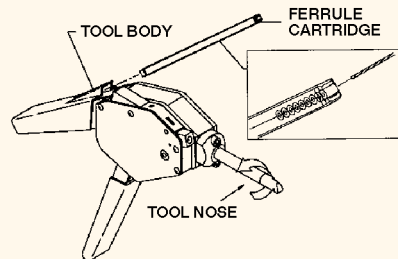
2.1.2. Install the ferrule cartridge into the tool body under the handle grip.

**NOTE**

When loading and using the Safe-T-Cable® hand tool, be certain that the correct size Safe-T-Cable® kit is being used with the tool.

2.1.3. Install the Safe-T-Cable® through the fasteners to be secured.

2.1.4. The nose can index to any position. To select the position grasp the nose, and rotate to the desire position (Figure 14).

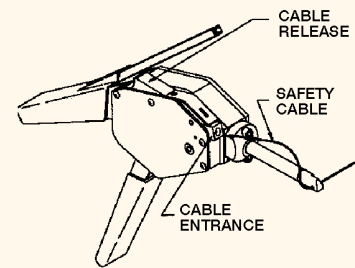


**FIGURE 14: Safe-T-Cable® Tools**

2.1.5. Insert the free end of the cable through the ferrule in the cartridge, and remove the ferrule by pulling the cable away from the end of the cartridge (Ref. Figure 14).

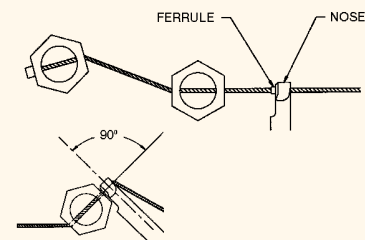
**NOTE**

Do not release the free end of the cable until it has been inserted through the tool nose.



**FIGURE 15: Pre-Set Tension Safe-T-Cable® Tool**

2.1.6. Insert the free end of the cable through the tool nose (Figure 15) and slide the tool along the cable to the fastener being secured (Figure 16).



**FIGURE 16: Position of Safe-T-Cable® Tool**

**3. Types of Safe-T-Cable® Tools**

3.1. The pre-set tension tool (Figures 14 and 15). Insert the free end of the cable into the cable entrance and continue to push the cable into the cavity. When the free end of the cable appears at the bottom of the tool, grip the cable and pull the slack from the cable until resistance is felt. Begin removing slack from the cable by repeatedly closing the tool handle allowing the handle to open fully before closing again. When all slack is removed from the cable, snug the tool against the fastener by using several short strokes of the handle. Release the handle to the full open position and fully close the handle to crimp securely and cut flush.

**CAUTION**

It is important on this final stroke to hold the tool as steady and perpendicular to the cable as possible while completing a full stroke. This assures consistent tensioning of the cable (Figure 16).

3.2 Adjustable tension tool (Figure 17). Thread the Safe-T-Cable® through the fastener, ferrule, and tool nose in the same way as with other models. Wrap the cable one full revolution (clockwise) around the tension wheel, and with slight pressure applied by pulling the cable, secure the cable into the slot. Rotate the tension knob until several clicks are heard and felt. If additional tension is required, adjustment can be made with the tension adjuster on the opposite side of the tool.

### CAUTION

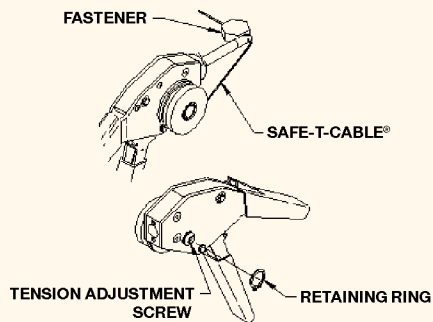
Do not overtighten Safe-T-Cable®. It is a good practice to find a tension setting which removes the slack from the cable (in order to meet the flex limit requirement), without over stressing the Safe-T-Cable® components.

3.2.1 Completely close the handle to crimp and cut the cable. Hold the tool steady and perpendicular to the cable to maintain consistent cable tension. Release the handle and remove the tool from the crimped ferrule. Remove the excess cable segment from the tool prior to the next application.

3.2.2 If it is more convenient to use the adjustable tension tool with the wheel located on the opposite side, you may remove the retaining ring located below the tension adjuster, slide the knob assembly out of the tool body, and re-insert it on the opposite side. Re-install the retaining ring (Figure 17).

### NOTE

When using a hand tool, the tool handle is to remain fully open during the cable entry process (in both tool models). The handle is to be actuated in the pre-set tension model after the tension pawl is engaged with the cable, and in the adjustable tension model only after the desired tension is achieved.



**FIGURE 17: Adjustable Tension Safe-T-Cable® Tool**

**4. The SCTP Pneumatic Safe-T-Cable® application tool (Figure 18). Connect the Pneumatic Safe-T-Cable® Tool to a clean, dry air supply of 80 to 100 psi.**

4.1. Install the Safe-T-Cable® through the fasteners which are to be secured.

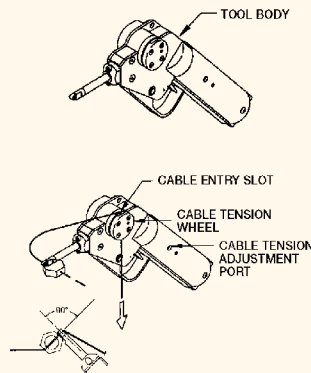
4.2. The nose can be indexed any position. To select the position grasp the nose and rotate to the desired position.

4.3. Insert the free end of the cable through the ferrule in the cartridge and remove the ferrule by pulling the cable away from the end of the cartridge. Insert the free end of the cable through the nose of the tool and slide the tool along the cable to the desired position.

4.4. Rotate the cable tensioning wheel clockwise if necessary to move the cable entry slot to an accessible position. Align the nose such that the ferrule is pressed squarely against the fastener. Make certain that the ferrule is fully seated into the nose. Insert the free end of the cable into the cable entry slot of the cable tensioning wheel. When the end of the cable exits the wheel, grip the cable and pull the slack from the cable. Do not leave more than 1-1/2" of total slack in the cable.

4.5. Press the trigger and hold. The tool will apply tension to the cable, crimp and cut. When the trigger is released, the crimp mechanism will retract (after the cycle is complete), and the tool nose can be moved from the ferrule. The excess cable shall be discarded.

4.6. The tension is adjustable by inserting the manufacturer supplied adjustment key into the adjustment port located on the tool handle. Clockwise rotation increases tension, and counter clockwise rotation decreases tension.



**FIGURE 18: Pneumatic Safe-T-Cable® Application Tool**

**5. The SCTPR Pneumatic Adjustable Tension Safe-T-Cable® application tool. Connect the Pneumatic Safe-T-Cable® Tool to a clean, dry air supply of 80 to 100 psi.**

5.1. Install the Safe-T-Cable® through the fasteners which are to be secured.

5.2. The nose can be indexed any position. To select the position grasp the nose and rotate to the desired position.

5.3. Insert the free end of the cable through the ferrule in the cartridge and remove the ferrule by pulling the cable away from the end of the cartridge. Insert the free end of the cable through the nose of the tool and slide the tool along the cable to the desired position.

5.4. Wrap the cable around the tensioning wheel in a clockwise direction, while holding the tool nose perpendicular to the fastener. Make certain that the ferrule is still fully seated in the nose. Rotate the tensioning wheel in a clockwise direction until the internal clutch slips. A clicking noise can be heard and felt.

5.5. Press the trigger and hold. The tool will crimp the ferrule and cut the cable. When the trigger is released, the crimp mechanism will retract (after the cycle is complete), and the tool nose can be moved from the ferrule. Unwind the excess cable from the tensioning wheel and dispose of or recycle excess cable.

5.6. The tension is adjustable by the adjustment screw, located on the opposite side of the tool from the tension wheel. Turning the tension adjustment screw clockwise increases cable tension. Turning the tension adjustment screw counterclockwise decreases cable tension.

**6. The Battery Powered Adjustable Tension Safe-T-Cable® application tool.**

6.1. Install the Safe-T-Cable® through the fasteners which are to be secured.

6.2. The nose can be indexed any position. To select the position grasp the nose and rotate to the desired position.

6.3. Insert the free end of the cable through the ferrule in the cartridge and remove the ferrule by pulling the cable away from the end of the cartridge. Insert the free end of the cable through the nose of the tool and slide the tool along the cable to the desired position.

6.4. Wrap the cable around the tensioning wheel in a clockwise direction, while holding the tool nose perpendicular to the fastener. Make certain that the ferrule is still fully seated in the nose. Rotate the tensioning wheel in a clockwise direction until the internal clutch slips. A clicking noise can be heard and felt.

6.5. Press the trigger and hold. The tool will crimp the ferrule and cut the cable. When the trigger is released, the crimp mechanism will retract (after the cycle is complete), and the tool nose can be moved from the ferrule. Unwind the excess cable from the tensioning wheel and dispose of or recycle excess cable.

6.6. The tension is adjustable by the adjustment screw, located on the opposite side of the tool from the tension wheel. Turning the tension adjustment screw clockwise increases cable tension. Turning the tension adjustment screw counterclockwise decreases cable tension.

**7. Safe-T-Cable® Application Tool Maintenance and Calibration. The Safe-T-Cable® tools should be stored in a clean, dry place when not in use. Clean any debris (especially in the crimp cavity in the tool nose) from the tool with a small brush and solvent if necessary. Lubricate the tool nose (in the crimp cavity) with a drop of oil on a regular basis.**

7.1. Calibration instructions are supplied with each tool.

# Safe-T-Cable® National Stock Numbers Listings

NSN	PART #	TOOLS AND KITS
5110-01-463-6819	SCTR203	Adjustable Tension Safe-T-Cable® Tool W/3" Nose For .022 Diameter Cable
5110-01-463-7115	SCTR207	Adjustable Tension Safe-T-Cable® Tool W/7" Nose For .022 Diameter Cable
5120-01-413-8726	SCTN20-3	Nose Assembly For .022 Safe-T-Cable® Tool , 3" Length
5110-01-463-6820	SCTN20-7	Nose Assembly For .022 Safe-T-Cable® Tool , 7" Length
5120-01-413-8727	SCT320	Safe-T-Cable® Tool Frame (Requires Nose Assembly To Be Complete)
5120-01-453-1506	SCTR323	Adjustable Tension Safe-T-Cable® Tool W/3" Nose For .032 Diameter Cable
5120-01-516-5557	SCTR323	Adjustable Tension Safe-T-Cable® Tool W/3" Nose For .032 Diameter Cable
5120-01-413-8725	SCTN32-3	Nose Assembly For .032 Safe-T-Cable® Tool , 3" Length
5120-01-413-8727	SCTN32-7	Nose Assembly For .032 Safe-T-Cable® Tool , 7" Length
5120-01-440-5129	SCT327	Pre-Set Tension Safe-T-Cable® Tool W/3" Nose For .032 Diameter Cable
5110-01-463-7117	SCTR327	Adjustable Tension Safe-T-Cable® Tool W/7" Nose For .032 Diameter Cable
5130-01-575-0335	SCTP323	Pneumatic Safe-T-Cable® Tool W/3" Nose For .032 Diameter Cable
5120-01-453-1502	SCTN32-9	Nose Assembly For .032 Safe-T-Cable® Tool , 9" Length
5120-01-459-0350	SCTN40-3	Nose Assembly For .040 Safe-T-Cable® Tool , 3" Length
5120-01-449-0969	SCTR407	Adjustable Tension Safe-T-Cable® Tool W/7" Nose For .040 Diameter Cable
5120-01-456-2590	SCTN40-7	Nose Assembly For .040 Safe-T-Cable® Tool , 7" Length
5120-01-498-1529	SCTH625	Hydraulic Safe-T-Cable® Tool W/5" Nose For .062 Diameter Cable
5120-01-498-1511	SCTHN62-5	Nose Assembly For .062 Safe-T-Cable® Tool , 5" Length
5120-01-498-1545	SCTHN62-9	Nose Assembly For .062 Safe-T-Cable® Tool , 9" Length
5120-01-463-7122	SCTD0001	Torque Wrench, 150 Inch-Pound Range
5120-01-498-1470	SCTD0001	Torque Wrench, 150 Inch-Pound Range
6635-01-416-9870	SCT-TB1	Torque Verification Block For .022", .032" & .040" Safe-T-Cable® Tools
6635-01-551-3297	SCT-TB1R	Torque Verification Block For .022", .032" & .040" Safe-T-Cable® Tools
6635-01-462-4438	SCT-TB2	Torque Verification Block For .062" Safe-T-Cable® Tools
5120-01-498-1509	SCTD011	Torque Wrench, 750 Inch-Pound Range
5180-01-492-2670	DMC1001	Tool Kit For .022" Safe-T-Cable® Applications
5180-01-452-2175	DMC1000	Tool Kit For .032" Safe-T-Cable® Applications
5120-01-449-2669	DMC1000-11R	Adjustable Tension Tool Kit For .040" Safe-T-Cable® Applications
5180-01-498-1237	DMC1000-32NAV	Adjustable Tension Tool Kit For .032" Safe-T-Cable® (Soft Case)
5180-01-550-2331	DMC1000-20R	Adjustable Tension Tool Kit For .022" & .032" Safe-T-Cable® Applications
5180-01-498-1507	DMC1000-62NAV	Adjustable Tension Tool Kit For .062" Safe-T-Cable® (Soft Case)
5180-01-586-3020	DMC1000-4R	Tool Kit With Test Block For .032" Safe-T-Cable® Applications



# Safe-T-Cable® National Stock Numbers Listings

NSN	PART #	SAFE-T-CABLE® (ALL ARE SUPPLIED 50 PIECES PER PKG)
5342-01-387-1906	A10-212	Safe-T-Cable® Assembly .032" Dia X 12" Length (Ferrules Not Included)
4010-01-508-6610	A10-218	Safe-T-Cable® Assembly .032" Dia X 18" Length (Ferrules Not Included)
4010-01-508-6604	A10-224	Safe-T-Cable® Assembly .032" Dia X 24" Length (Ferrules Not Included)
4010-01-504-1483	A10-924	Safe-T-Cable® Assembly .062" Dia X 24" Length (Ferrules Not Included)
5342-01-414-6581	C10-112	Safe-T-Cable® Kit .022" Diameter X 12" Length
5342-01-414-6583	C10-118	Safe-T-Cable® Kit .022" Diameter X 18" Length
5340-01-572-9621	C08-124N	Safe-T-Cable® Kit .022" Diameter X 24" Length (Inconel 625)
5342-01-414-6584	C10-212	Safe-T-Cable® Kit .032" Diameter X 12" Length
5342-01-414-6582	C10-218	Safe-T-Cable® Kit .032" Diameter X 18" Length
5340-01-495-4038	C10-218EFR	Safe-T-Cable® Kit .032" Diameter X 18" Length With F10-06 Ferrules
5340-01-551-3251	C10-218JA	Self-Looping Safe-T-Cable® Kit .032" Diameter X 18" Length
5340-01-468-6658	C09-218	Safe-T-Cable® Kit .032" Diameter X 18" Length (Inconel 600)
5120-01-473-7392	C10-224	Safe-T-Cable® Kit .032" Diameter X 24" Length
5120-01-453-1505	C10-224	Safe-T-Cable® Kit .032" Diameter X 24" Length
5340-01-452-0343	C10-318	Safe-T-Cable® Kit .040" Diameter X 18" Length
5340-01-452-0345	C10-324	Safe-T-Cable® Kit .040" Diameter X 24" Length
5120-01-453-1508	C10-924	Safe-T-Cable® Kit .062" Diameter X 24" Length
5340-01-496-6089	F10-1	Ferrule For .022" Diameter Safe-T-Cable®
5342-01-387-1796	F10-2	Ferrule For .032" Diameter Safe-T-Cable®
5342-01-414-0319	F10-04	Elongated Ferrule For .032" Diameter Safe-T-Cable®
5340-01-474-6482	F10-06	Elongated Conical Ferrule For .032" Diameter Safe-T-Cable®
5340-01-504-1488	F10-9	Ferrule For .062" Diameter Safe-T-Cable®

NSN	PART #	MISCELLANEOUS
9150-01-501-1348	4-1439	8 oz. Bottle Hydraulic Fluid (32aw)
5120-01-498-1476	SCTD012	Retaining Ring Pliers
5120-01-498-1535	SCT32059SA	2" Nose Extender For .022", .032" & .040" Safe-T-Cable® Tools
5110-01-431-0976	45-6N	Diagonal Cutter / Gripper For Safe-T-Cable®
5140-01-498-1245	SCT-SCC32-1	Soft Carrying Case Only For DMC1000-32NAV
5140-01-498-1508	SCT-SCC62-1	Soft Carrying Case Only For DMC1000-62NAV
5110-01-509-6707	SCTD5015	Safe-T-Cable Diagonal Cutters
5120-01-498-1482	SCT32084	Spanner Wrench

# FAA Classification Letter



Federal Aviation Administration

Nov. 23, 1993

Mr. David Kelly  
Director of Corporate Planning  
Daniels Manufacturing Corporation  
526 Thorpe Road  
Orlando, FL 32824

Dear Mr. Kelly:

This letter is a follow up to our conversation of October 20 concerning an acceptable means of approving safety cable for installation on aircraft.

The Federal Aviation Administration (FAA) has determined that safety cable manufactured in accordance with Society of Automotive Engineers (SAE) Aerospace Standard 3509 (AS3509), AS3510, and AS3511 would be a standard parts under Federal Aviation Regulation (FAR) § 21.303 (b) (4). As such, safety cable manufactured in accordance with AS3509, AS3510, and AS3511 do not require a Parts Manufacturer Approval.

Installation of AS3509, AS3510, and AS3511 safety cable on aircraft is governed by FAR § 43.13, Performance Rules (general). FAR § 43.13 (a) states in part: "Each person performing maintenance, alteration, or preventative maintenance on an aircraft, engine, propeller, or appliance shall use the methods, techniques, and practices prescribed in the current manufacturer's maintenance manual or Instructions for Continued Airworthiness prepared by its manufacturer, or other methods, techniques, and practices acceptable to the Administrator..."

In the absence of explicit instructions by the aircraft manufacturer (type certificate holder) for the use of safety cable, the installer could meet the provisions of FAR § 43.13 (b). FAR § 43.13 (b) states: "Each person maintaining or altering, or performing preventive maintenance, shall do that work in such a manner and use materials of such a quality, that the condition of the aircraft, airframe, aircraft engine, propeller, or appliance worked on will be at least equal to its original or properly altered condition (with regard to aerodynamic function, structural strength, resistance to vibration and function, structural strength, resistance to vibration and deterioration, and other qualities affecting airworthiness)." The installer would need to provide data to the FAA that substantiates that the safety cable installed was equal to or better than the safety wire called out by the type certificate holder. This data could consist of certified comparative performance testing conducted by a specification issuing body (in this case SAE) or could be a comparison of the safety wire specifications vs. safety cable specifications showing where all aspects of the performance of safety cable is equal to or better than that of safety wire. In either case, the data must also specify, by part numbers, which safety cable could replace which safety wire.

If I can be of further assistance, please contact me at (202) 267-9596.

Sincerely,

A handwritten signature in black ink, appearing to read "Bruce A. Kaplan".

Bruce A. Kaplan  
Policy and Procedures Branch  
Aircraft Engineering Division  
Aircraft Certification Service

# F.A.R. Reference And Limited Warranty

## Subpart K — Approval of Materials, Parts, Processes, and Appliances

SOURCE: Docket No. 5085, 29 FR 14574. Oct. 24, 1964, unless otherwise noted.

### § 21.301 Applicability.

This subpart prescribes procedural requirements for the approval of certain materials, parts, processes, and appliances.

### § 21.303 Replacement and modification parts.

(a) Except as provided in paragraph (b) of this section, no person may produce a modification or replacement part for sale for installation on a type certificated product unless it is produced pursuant to a Parts Manufacturer Approval issued under this subpart.

(b) This section does not apply to the following:

- (1) Parts produced under a type or production certificate.
- (2) Parts produced by an owner or operator for maintaining or altering his own product.
- (3) Parts produced under an FAA Technical Standard Order.
- (4) Standard parts (such as bolts and nuts) conforming to established industry or U.S. specifications.

(c) An application for a Parts Manufacturer Approval is made to the Manager of the Aircraft Certification Office for the geographic area in which the manufacturing facility is located and must include the following:

- (1) The identity of the product on which the part is to be installed.
- (2) The name and address of the manufacturing facilities at which these parts are to be manufactured.
- (3) The design of the part, which consists of—
  - (i) Drawings and specifications necessary to show the configuration or the part; and
  - (ii) Information on dimensions, materials, and processes necessary to define the structural strength of the part.
- (4) Test reports and computations necessary to show that the design of the part meets the airworthiness requirements of the Federal Aviation

(3) Any alteration, for fraudulent purpose, of any record or report under this part

(b) The commission by any person of an act prohibited under paragraph (a) of this section is a basis for suspending or revoking the applicable airman, operator, or production certificate, Technical Standard Order Authorization, FAA-Parts Manufacturer Approval, or Product and Process Specification issued by the Administrator and held by the person.

[Amdt. 43-19 FR 22639, May 25, 1978, as amended by Amdt. 43-23, 47 FR 41085, Sept. 16, 1982]

### § 43.13 Performance rules (general).

(a) Each person performing maintenance, alteration, or preventative maintenance on an aircraft, engine, propeller, or appliance shall use the methods, techniques, and practices prescribed in the current manufacturer's maintenance manual or Instructions for Continued Airworthiness prepared by the manufacturer, or other methods, techniques, and practices acceptable to the Administrator, except as noted in § 43.16. He shall use the tools, equipment, and test apparatus is recommended by the manufacturer involved, he must use that equipment or apparatus or its equivalent acceptable to the Administrator.

(b) Each person maintaining or altering, or performing preventive maintenance, shall do that work in such a manner and use materials of such a quality, that the condition of the aircraft, airframe, aircraft engine, propeller, or appliance worked on will be at least equal to its original or properly altered condition (with regard to aerodynamic function, structural strength, resistance to vibration and deterioration, and other qualities affecting airworthiness).

(c) *Special provisions for holders of air carrier operating certificates and operating certificates issued under the provisions of Part 121, 127, or 135 and Part 129 operators holding operations specifications. Unless otherwise notified.*

**NOTICE: This printing of the Federal Acquisition Regulation is current with the date of the FAA letter (previous page).**

## Limitation of Liability/Limited Warranty\*

**DANIELS MANUFACTURING CORPORATION IS NOT LIABLE FOR CONSEQUENTIAL OR SPECIAL DAMAGES OF ANY NATURE OR KIND RESULTING FROM THE USE OF ANY OF ITS PRODUCTS. OWNERS AND USERS OF DMC PRODUCTS ASSUME FULL RESPONSIBILITY FOR INSTRUCTING THEIR EMPLOYEES IN THE PROPER AND SAFE USE OF SUCH PRODUCTS.**

Daniels Manufacturing Corporation warrants each new unit sold by it to be free from defects in material and workmanship under normal use and service. Its obligation under this warranty is limited to the free correction or, at its option, the refund of the purchase price of any such unit which proves defective within ninety (90) days after delivery to the first user, provided that the unit is returned to it with all transportation charges prepaid, and which shall appear to its satisfaction, upon inspection by it, to have been defective in material or workmanship. This warranty shall not cover any damage to such products, which in the opinion of Daniels Manufacturing Corporation, was caused by normal wear, misuse, improper operation or accident. This warranty is in lieu of all other warranties express or implied. No warranty, express or implied, is made or authorized to be made or assumed with respect to products of Daniels Manufacturing Corporation, other than that herein set forth.

\*as defined by PL93-637



526 THORPE ROAD • ORLANDO, FLORIDA 32824-8133 USA  
(407) 855-6161 • FAX (407) 855-6884  
E-MAIL: DMC@DMCTOOLS.COM • WWW.DMCTOOLS.COM



526 Thorpe Road • Orlando, Florida 32824 USA  
Phone: 407-855-6161 • Fax: 407-855-6884  
E-Mail: [dmc@dmctools.com](mailto:dmc@dmctools.com)

**[WWW.DMCTOOLS.COM](http://WWW.DMCTOOLS.COM)**

© COPYRIGHT 2011 DANIELS MANUFACTURING CORP., ALL RIGHTS RESERVED.

# Mouser Electronics

Authorized Distributor

Click to View Pricing, Inventory, Delivery & Lifecycle Information:

## Daniels Manufacturing:

[SCTP207](#) [C10-918PKG](#) [C10-218EFPKG](#) [C10-124](#) [C10-209](#) [C10-218](#) [C10-224](#) [C10-215](#) [C10-118](#) [C10-318](#) [C10-212PKG](#) [C09-324PKG](#) [A10-218PKG](#) [C09-212PKG](#) [F10-04PKG](#) [F10-1PKG](#) [F10-04](#) [F10-1](#) [F09-07PKG](#) [SCTE327B](#) [SCTE327B-230](#) [C09-118](#) [C09-218](#) [C09-318](#) [C09-324JAPKG](#) [C09-924PKG](#) [SCTPR207](#) [SCTPR323L](#) [SCTPR327](#) [SCTPR403](#) [SCTR323L](#) [SCTR323NC](#) [SCTN20-5](#) [SCTN20-7B](#) [SCTN32-9](#) [SCTN40-5](#) [SCTP403](#) [SCTPR203](#) [SCTE407](#) [SCTE407B](#) [SCTE407B-230](#) [SCTE625B](#) [SCTE629B](#) [SCTH629](#) [SCTE323B](#) [SCTE323B-230](#) [SCTE327](#) [SCTE403](#) [SCTE403B](#) [SCTE403B-230](#) [SCTD015](#) [SCTE203B](#) [SCTE203B-230](#) [SCTE207B](#) [SCTE207B-230](#) [SCTE323](#) [C10-218PKG](#) [SCT2010](#) [SCT323SG](#) [SCT325L](#) [SCT329](#) [SCT405](#) [SCTD0003](#) [SCT323L](#) [SCTE207](#) [SCTN40-5L](#) [SCTN62-37](#) [SCTN32-9L](#) [SCTN40-7L](#) [SCTPR407](#) [SCTR203ZA](#) [SCT205](#) [SCT3212](#) [SCTHN62-5](#) [SCTHN62-7](#) [SCTHN62-9](#) [SCTN20-3ZA](#) [SCTN20-7ZA](#) [SCTN32-5L](#) [SCTD0004](#) [SCTD0005](#) [SCTD0006](#) [SCTD012](#) [SCTE203](#) [SCTHN62-3](#) [C10-221PKG](#) [C10-224PKG](#) [C10-218JAPKG](#) [C10-124AR](#) [C10-124PKG](#) [SCTF10-11](#) [C10-315FEF](#) [C10-218EFETN](#) [C10-321PKG](#) [C10-321JAPKG](#) [C10-212TFC](#) [C10-115EFJA](#) [C10-315FEFPKG](#) [C10-218SER](#) [C10-921FEFPKG](#)