

Single relay - REL-IR4/LDP- 48DC/4X21 - 2903678

Please be informed that the data shown in this PDF Document is generated from our Online Catalog. Please find the complete data in the user's documentation. Our General Terms of Use for Downloads are valid (<http://phoenixcontact.com/download>)



Plug-in industrial relay with power contacts, 4 PDTs, test key, status LED, freewheeling diode, mechanical switch position indicator, polarity: A1+, A2-, coil voltage: 48 V DC



Key Commercial Data

Packing unit	10 pc
Minimum order quantity	10 pc
GTIN	 4 046356 758918
GTIN	4046356758918

Technical data

Dimensions

Width	21.2 mm
Height	27.5 mm
Depth	35.6 mm

Ambient conditions

Ambient temperature (operation)	-40 °C ... 70 °C
Ambient temperature (storage/transport)	-40 °C ... 85 °C
Degree of protection	RT I

Coil side

Nominal input voltage U_N	48 V DC
Input voltage range in reference to U_N	see diagram
Typical input current at U_N	22 mA
Typical response time	13 ms
Typical release time	14 ms
Protective circuit	Damping diode
Status display	Yellow LED

Single relay - REL-IR4/LDP- 48DC/4X21 - 2903678

Technical data

Coil side

Power dissipation for nominal condition	1.06 W
---	--------

Contact side

Contact type	4 PDTs
Type of switch contact	Single contact
Contact material	AgNi
Maximum switching voltage	250 V AC/DC
Minimum switching voltage	5 V (At 24 mA)
Min. switching current	5 mA (at 24 V)
Maximum inrush current	16 A (20 ms, N/O contact)
Limiting continuous current	6 A
Interrupting rating (ohmic load) max.	144 W (at 24 V DC)
	124 W (at 48 V DC)
	108 W (at 60 V DC)
	52 W (at 110 V DC)
	48 W (at 220 V DC)
	1500 VA (for 250 V AC)
Switching capacity min.	0.12 W
Switching capacity	2 A (at 24 V, DC13)
	0.22 A (at 120 V, DC13)
	0.11 A (at 250 V, DC13)
	1.5 A (at 24 V, AC15)
	1.5 A (at 120 V, AC15)
	1 A (at 240 V, AC15)
Motor load according to UL 508	1/3 HP, 240 V AC

General

Test voltage relay winding/relay contact	2.5 kV _{rms} (50 Hz, 1 min.)
Test voltage PDT/PDT	2 kV _{rms} (50 Hz, 1 min.)
Operating mode	100% operating factor
Mechanical service life	approx. 2x 10 ⁷ cycles
Service life, electrical	see diagram
Mounting position	any

Connection data

Connection method	Plug connection
-------------------	-----------------

Standards and Regulations

Connection in acc. with standard	CSA
Standards/regulations	IEC 60664
	IEC 61810
Rated insulation voltage	250 V AC
Rated surge voltage	2.5 kV

Single relay - REL-IR4/LDP- 48DC/4X21 - 2903678

Technical data

Standards and Regulations

Insulation	Basic insulation
Pollution degree	2
Overvoltage category	II

Environmental Product Compliance

China RoHS	Environmentally Friendly Use Period = 50
	For details about hazardous substances go to tab "Downloads", Category "Manufacturer's declaration"

Drawings

Diagram

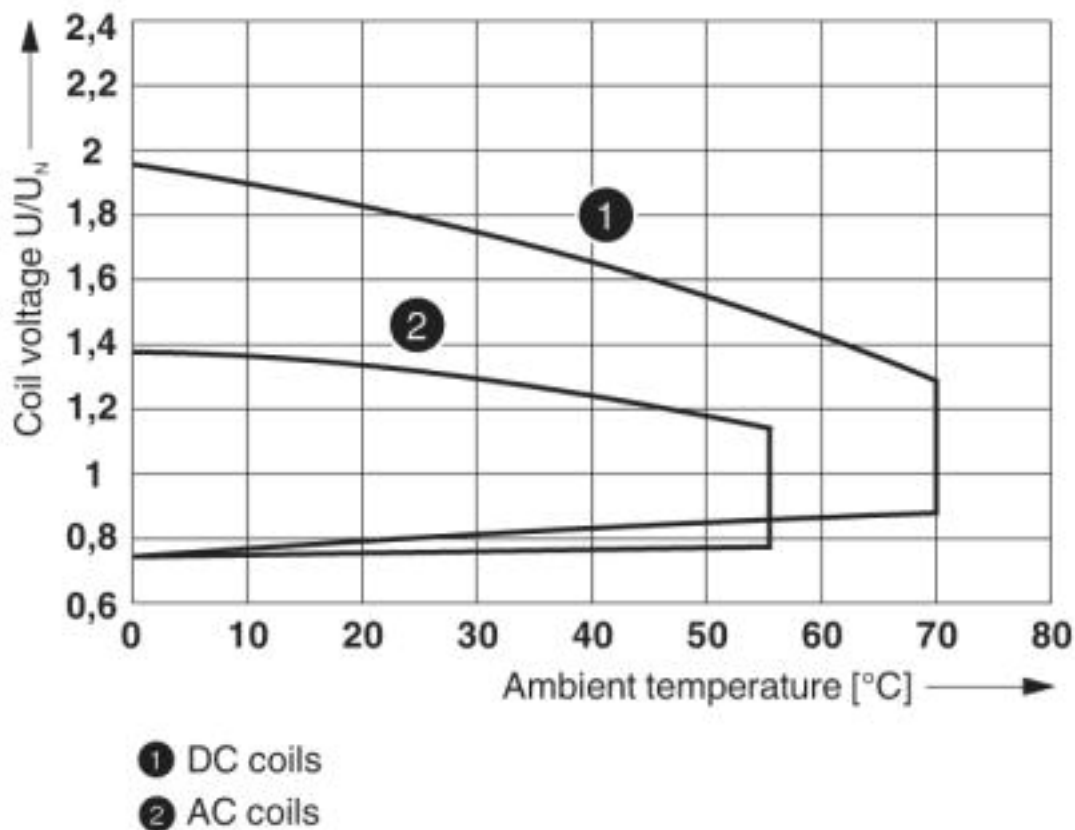

Operating voltage range

Single relay - REL-IR4/LDP- 48DC/4X21 - 2903678

Diagram

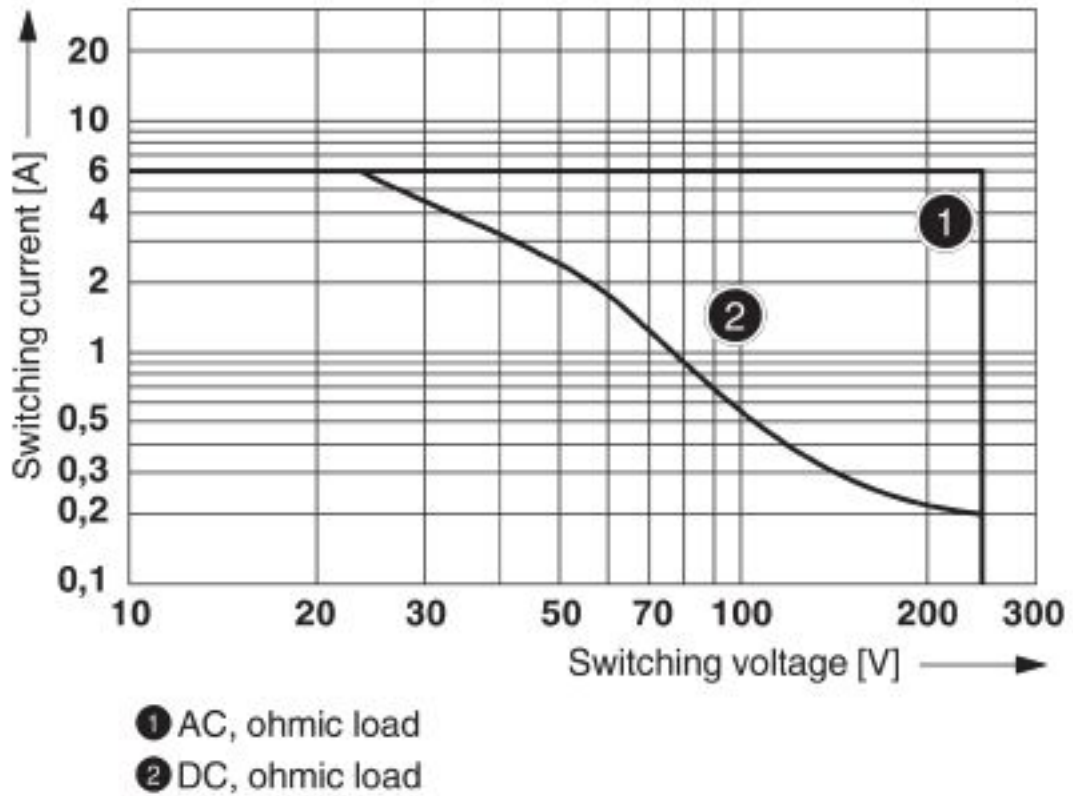

Interrupting rating

Single relay - REL-IR4/LDP- 48DC/4X21 - 2903678

Diagram

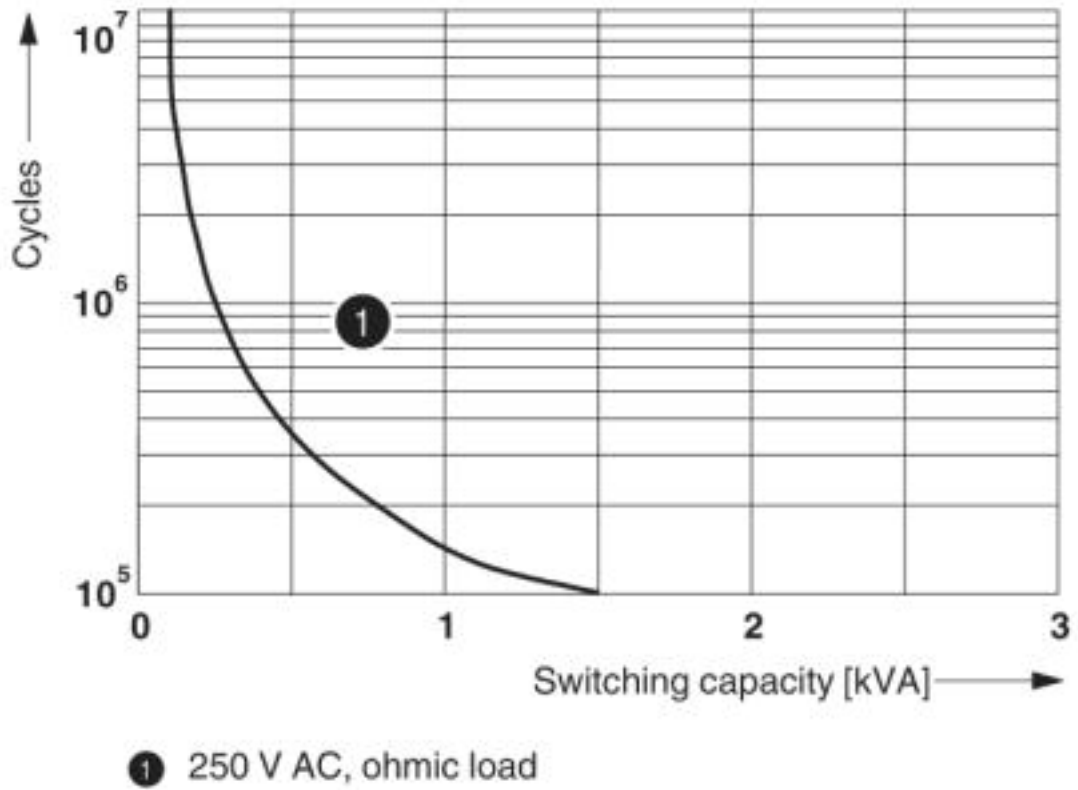

Electrical service life

Single relay - REL-IR4/LDP- 48DC/4X21 - 2903678

Diagram

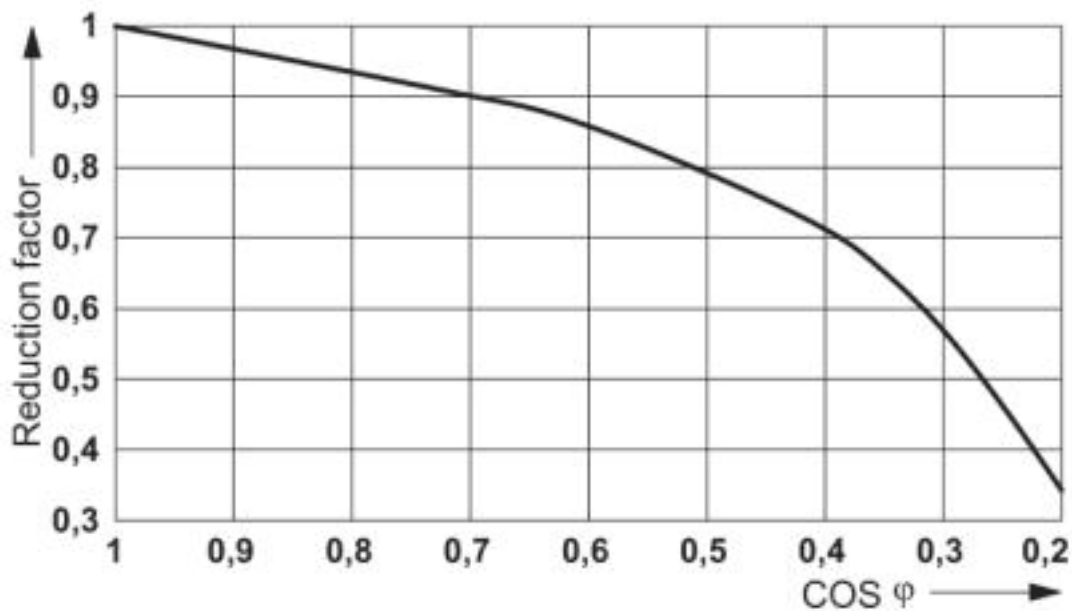

Service life reduction factor

Circuit diagram

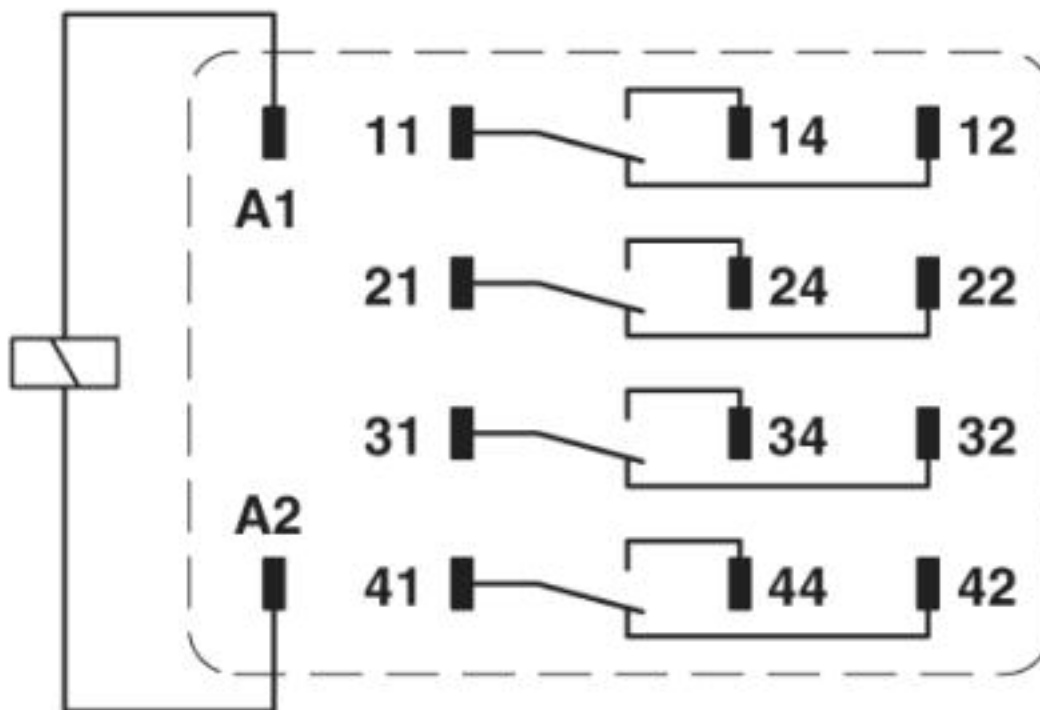

Single relay - REL-IR4/LDP- 48DC/4X21 - 2903678

Approvals







Approvals

Approvals

CSA / UL Recognized / cUL Recognized / VDE Zeichengenehmigung / EAC / cULus Recognized

Ex Approvals

Approval details

CSA		http://www.csagroup.org/services-industries/product-listing/	2554095
UL Recognized		http://database.ul.com/cgi-bin/XYV/template/LISEXT/1FRAME/index.htm	FILE E 172140
cUL Recognized		http://database.ul.com/cgi-bin/XYV/template/LISEXT/1FRAME/index.htm	FILE E 172140
VDE Zeichengenehmigung		http://www2.vde.com/de/Institut/Online-Service/VDE-gepruefteProdukte/Seiten/Online-Suche.aspx	40040427
EAC			TR_TS_D_00573_c
cULus Recognized			

Phoenix Contact 2019 © - all rights reserved
<http://www.phoenixcontact.com>

PHOENIX CONTACT GmbH & Co. KG
Flachmarktstr. 8
32825 Blomberg
Germany
Tel. +49 5235 300
Fax +49 5235 3 41200
<http://www.phoenixcontact.com>