



**SILERGY**

# Application Note: SA21345A

## 36V, 300mA LDO Regulator

### General Description

The SA21345A is an efficient, precise LDO designed for high input voltage and ultra low quiescent current applications.

The SA21345A provides adjustable output voltage and very low drop out (300mV at 300mA). Other features include the operation stability with low ESR ceramic or tantalum capacitors due to the optimized internal compensation, over current protection and thermal shutdown.

The SA21345A is available in SO8E package.

### Features

- Wide Input Voltage Range: 4V to 36V
- Low Dropout Voltage (300mV @ 300mA)
- Ultra-low Quiescent Current
- Extremely Low Shutdown Current
- Stability with Tantalum or Ceramic Capacitors
- Excellent Load and Line Regulation
- 300mA Maximum Load Current
- Enable Control Input
- Over Current Protection
- Thermal Shutdown
- Compact SO8E Package
- Automotive AEC- Q100 Grade 1 Certified

### Ordering Information

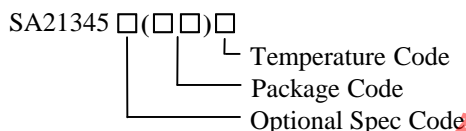

Ordering Number	Package type	Note
SA21345AFCA	SO8E	

### Applications

- Battery powered Applications
- Automotive Applications
- Gateway Applications
- Remote Keyless Entry Systems
- SMPS post-regulator/ DC-DC modules

### Typical Applications

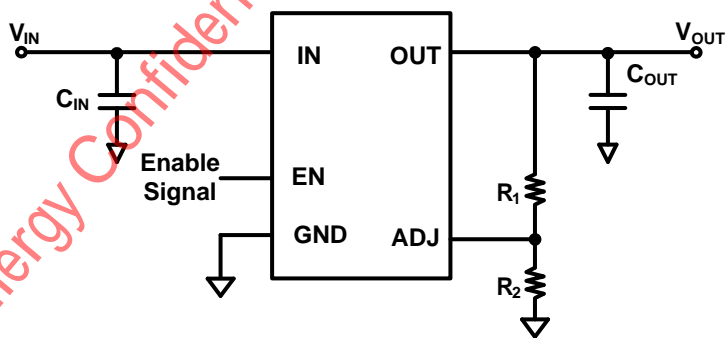

Figure1. Schematic Diagram

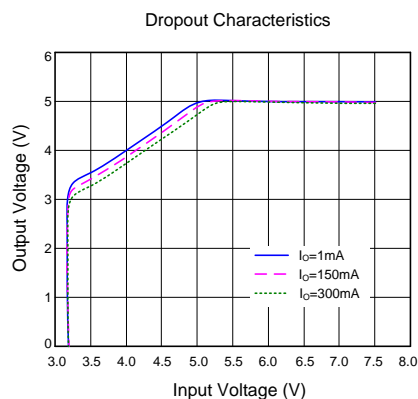
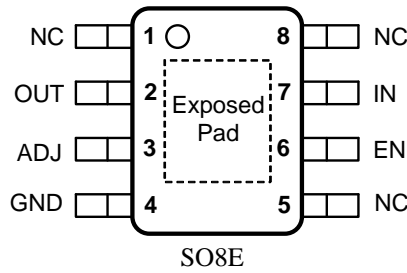

Figure2. Dropout Characteristics

## Pinout (top view)



Top mark: CSZxyz for (Device code: CSZ, x=year code, y=week code, z=lot number code)

## Pin Description

Pin Name	Pin Number	Pin Description
NC	1, 5, 8	Not connected
OUT	2	Output pin. Bypass this pin to Ground pin with a 2.2μF output capacitor.
ADJ	3	Output voltage adjust pin. Feedback the output voltage through resistor voltage divider network. $V_{OUT}=0.6 \times (1+R1/R2)$
GND	4	Ground pin.
EN	6	Enable pin. Pull it low to shutdown or pull it high to enable, do not leave floating.
IN	7	IC power supply input. Bypass this pin to Ground pin with a 10μF capacitor.
	Exposed Pad	The exposed pad should be connected to ground plane for better thermal performance.

## Block Diagram

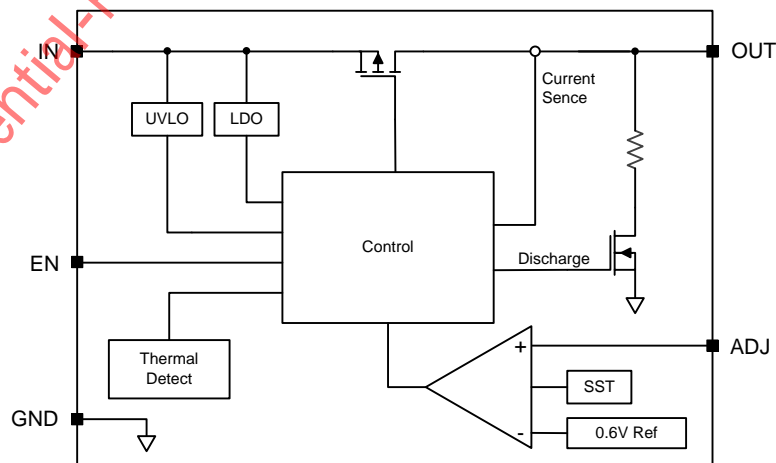

Figure3. Block Diagram

## Absolute Maximum Ratings (Note 1)

IN to GND	-0.3V to 40V
OUT, EN, ADJ to GND	-0.3V to 0.3V+V <sub>IN</sub>
Power Dissipation, PD @ T <sub>A</sub> = 25 °C SO8E	3.3W
Package Thermal Resistance (Note 2)	
θ <sub>JA</sub>	30 °C/W
θ <sub>JC</sub>	20 °C/W
Storage Temperature	-65 °C to +150 °C
Junction Temperature (T <sub>J</sub> ) (Note 5)	-40 °C to +150 °C
Lead Temperature (Soldering, 10sec.)	+260 °C

## Recommended Operating Conditions (Note 3)

Supply Input Voltage	4V to 36V
Ambient Temperature Range	-40 °C to 125 °C

Silergy Confidential-For 南京商络电子有限公司

## Electrical Characteristics

( $V_{IN}=12V$ ,  $V_{OUT}=3.3V$ ,  $V_{EN}=V_{IN}$ ,  $T_A = -40\text{ }^{\circ}\text{C}\sim 125\text{ }^{\circ}\text{C}$  unless otherwise specified, the values are guaranteed by test design or statistical correlation)

Parameter	Symbol	Test Conditions	Min	Typical	Max	Unit
Input Voltage	$V_{IN}$	$I_{OUT}=10\text{mA}$	4		36	V
Reference Voltage	$V_{REF}$		582	600	618	mV
Line Regulation	$\Delta V_{LNR}$	$V_{IN}=(V_{OUT}+0.3V)$ to 36V, $I_O=10\text{mA}$		1	1.5	mV/V
Load Regulation	$\Delta V_{LDR}$	$I_O=10\text{mA}$ to 300mA		0.25	1	%
Dropout Voltage	$V_{IN}-V_{OUT}$	$I_O=10\text{mA}$		10	20	mV
		$I_O=150\text{mA}$		150	300	mV
		$I_O=300\text{mA}$		300	550	mV
Quiescent Current	$I_Q$	No Load		7	14	$\mu\text{A}$
Shutdown Current	$I_{SHDN}$	$V_{EN}=0V$ , $V_{IN}=24V$			5	$\mu\text{A}$
Output Current	$I_O$	$V_{IN}=V_{OUT}+0.6V$	0		300	mA
Output Current limit	$I_{LIM}$	$V_{IN}=6V$ , $V_{OUT}=0.9\times V_{OUT}(\text{normal})$	300		900	mA
Power-supply Rejection Ratio	PSRR	$f=1\text{kHz}$ , $C_{OUT}=10\mu\text{F}$		60		dB
		$f=150\text{kHz}$ , $C_{OUT}=10\mu\text{F}$		30		dB
Input UVLO Threshold	$V_{UVLO}$	$V_{IN}$ rising	2.9	3.4	4	V
UVLO Hysteresis	$V_{UVLO\_HYS}$			0.1		V
Shutdown Discharge Resistance	$R_{DIS}$			600		$\Omega$
Enable Input Logic-High Voltage	$V_{EN\_H}$	$V_{IN}=5V$	1.5			V
Enable Input Logic-Low Voltage	$V_{EN\_L}$	$V_{IN}=5V$			0.4	V
Thermal Shutdown Temperature(Note 4)	$T_{SD}$			150		$^{\circ}\text{C}$
Thermal Shutdown hysteresis (Note 4)	$T_{HYS}$			20		$^{\circ}\text{C}$

**Note 1:** Stresses beyond the “Absolute Maximum Ratings” may cause permanent damage to the device. These are stress ratings only. Functional operation of the device at these or any other conditions beyond those indicated in the operational sections of the specification is not implied. Exposure to absolute maximum rating conditions for extended periods may affect device reliability.

**Note 2:**  $\theta_{JA}$  is measured in the natural convection at  $T_A = 25\text{ }^{\circ}\text{C}$  on a low effective two-layer thermal conductivity test board of JEDEC 51-3 thermal measurement standard.

**Note 3:** The device is not guaranteed to function outside its operating conditions.

**Note 4:** Guaranteed by design.

**Note 5:** Operating lifetime is derated for junction temperatures greater than 125  $^{\circ}\text{C}$ .

## Typical Performance Characteristics

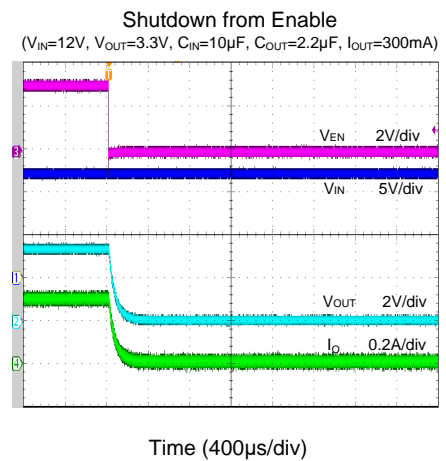
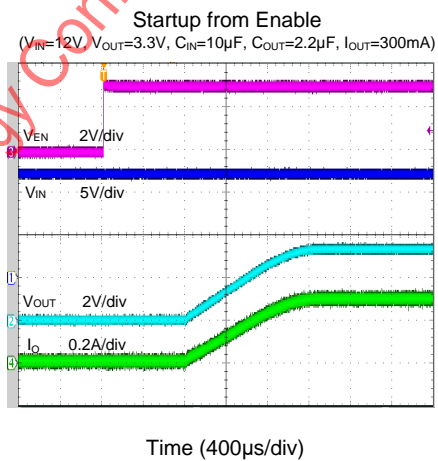
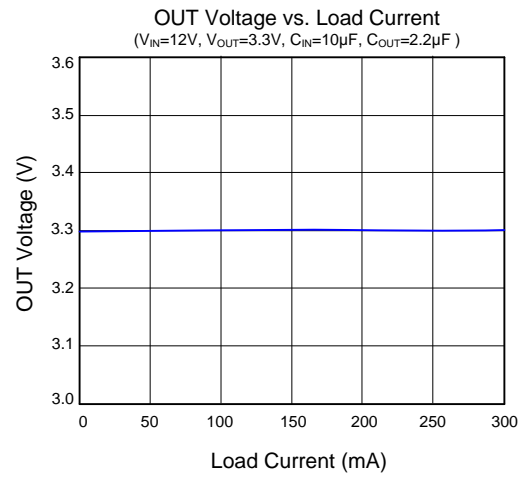
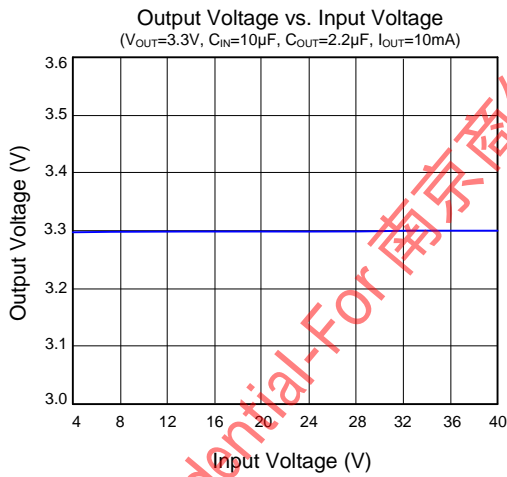
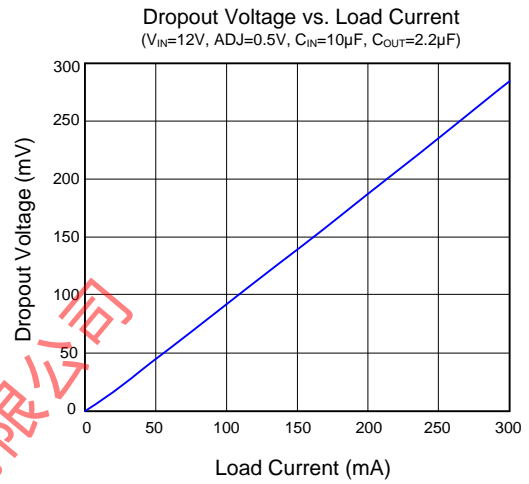
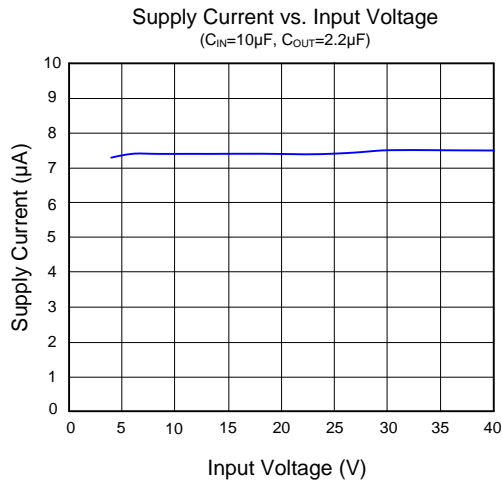

**Startup from  $V_{IN}$**   
 $(V_{IN}=12V, V_{OUT}=3.3V, C_{IN}=10\mu F, C_{OUT}=2.2\mu F, I_{OUT}=300mA)$

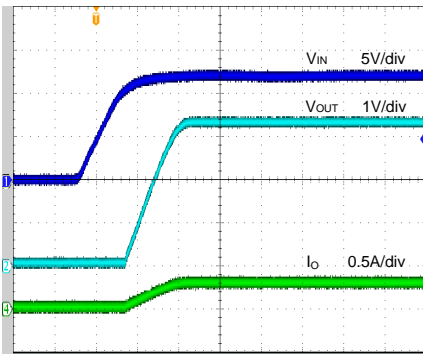

Time (800 $\mu$ s/div)

**Shutdown from  $V_{IN}$**   
 $(V_{IN}=12V, V_{OUT}=3.3V, C_{IN}=10\mu F, C_{OUT}=2.2\mu F, I_{OUT}=300mA)$

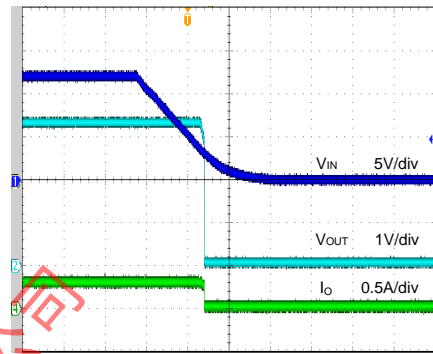

Time (10ms/div)

**Load Transient**  
 $(V_{IN}=12V, V_{OUT}=3.3V, C_{IN}=10\mu F, C_{OUT}=2.2\mu F, I_{OUT}=10mA \sim 300mA \sim 10mA)$

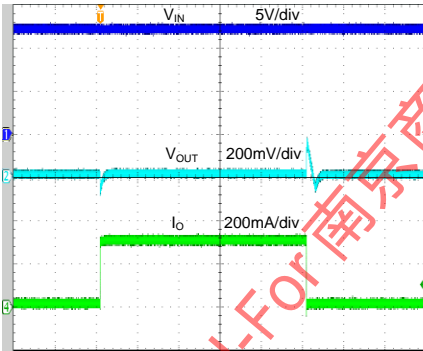

Time (200 $\mu$ s/div)

**Line Transient**  
 $(V_{IN}=8V \sim 18V \sim 8V, V_{OUT}=5V, C_{IN}=10\mu F, C_{OUT}=2.2\mu F, I_{OUT}=300mA)$

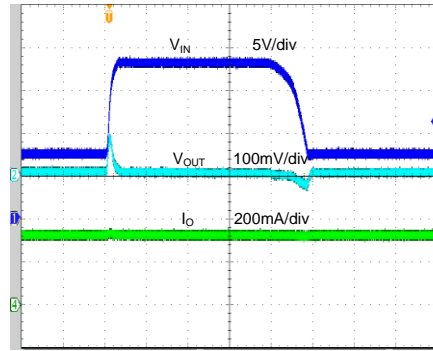

Time (400 $\mu$ s/div)

**PSRR**  
 $(V_{IN}=12V, V_{OUT}=3.3V, C_{IN}=Null, C_{OUT}=2.2\mu F, I_{OUT}=10mA)$

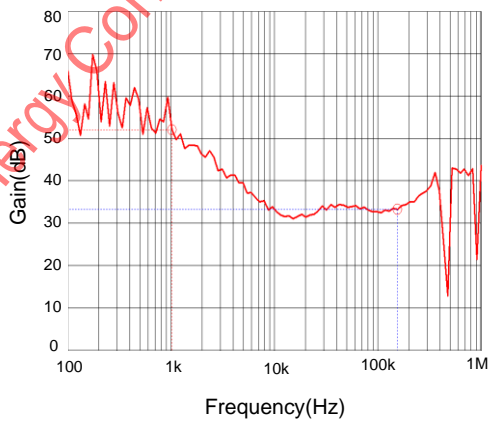

**PSRR**  
 $(V_{IN}=12V, V_{OUT}=3.3V, C_{IN}=Null, C_{OUT}=2.2\mu F, I_{OUT}=300mA)$

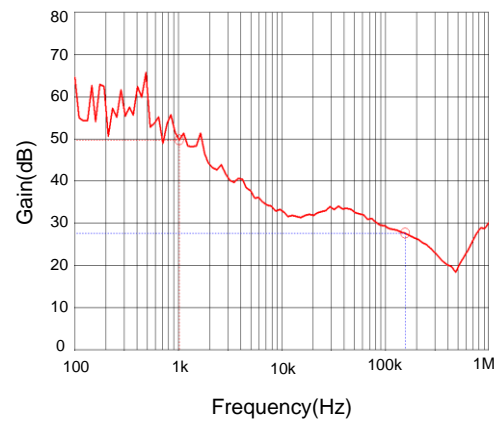

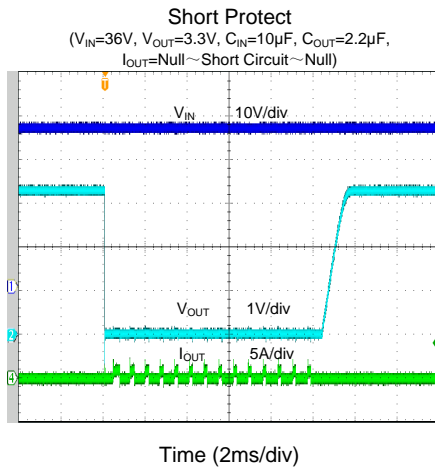

Silergy Confidential-For 南京商络电子有限公司

## Operation

The SA21345A is a 300mA linear regulator with a low drop out voltage. Like any low-dropout regulator, the SA21345A requires input and output decoupling capacitors. The SA21345A has an adjustable output which can be set by two external resistors. The device with fully protection includes over current limit, output short protection and over temperature operation.

## Applications Information

### Feedback Resistor Dividers R<sub>1</sub> and R<sub>2</sub>:

Choose R<sub>1</sub> and R<sub>2</sub> to program the proper output voltage. To minimize the power consumption under light loads, it is desirable to choose large resistance values for both R<sub>1</sub> and R<sub>2</sub>. A value of between 10kΩ and 10MΩ is highly recommended for both resistors. If V<sub>OUT</sub> is 3.3V, R<sub>1</sub>=1.6MΩ is chosen, then using following equation, R<sub>2</sub> can be calculated to be 357kΩ:

$$R_2 = \frac{0.6V}{V_{OUT} - 0.6V} R_1$$

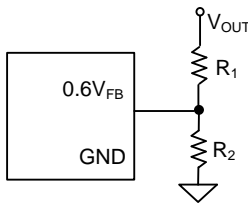

### Input Capacitor C<sub>IN</sub>:

An input capacitor about 10μF is required between the device input pin and ground pin. A typical X5R or better grade ceramic capacitor is recommended in this application. This input capacitor must be located close to the device to minimize the input noise.

### Output Capacitor C<sub>OUT</sub>:

For transient stability, the SA21345A is designed specifically to work with very small ceramic output capacitors. 2.2μF output capacitance can be used in this application. Higher capacitance values help to improve transient. The output capacitor's ESR is critical because it forms a zero to provide phase lead which is required for loop stability.

### Dropout Voltage:

The SA21345A has a very low dropout voltage due to its extra low R<sub>DS(ON)</sub> of the main PMOS determines the lowest usable supply.

$$V_{DROPOUT} = V_{IN} - V_{OUT} = R_{DS(ON)} \times I_{OUT}$$

### Over Current and Short Circuit Protection:

The device includes over current and short circuit protection. The current limitation circuit regulates the output current to its limitation threshold to protect IC from damage. Under over current or short circuit condition, the power loss of the IC is relative high. And that may trigger the thermal protection.

### Thermal Considerations:

The SA21345A can deliver a current of up to 300mA over the full operating temperature range. However, the maximum output current must be derated at higher ambient temperature. With all possible conditions, the junction temperature must be within the range specified under operating conditions. Power dissipation can be calculated based on the output current and the voltage drop across regulator.

$$P_D = (V_{IN} - V_{OUT}) \times I_{OUT} + V_{IN} \times I_{GND}$$

The final operating junction temperature for any set of condition can be estimated by the following thermal equation:

$$P_{D(MAX)} = (T_{J(MAX)} - T_A) / \theta_{JA}$$

Where T<sub>J(MAX)</sub> is the maximum junction temperature of die and T<sub>A</sub> is the maximum ambient temperature. The junction to ambient thermal resistance (θ<sub>JA</sub>) footprint is 30 °C/W for SO8E package.

### Load Transient Considerations:

The SA21345A integrates the compensation components to achieve good stability and fast transient responses. In some applications, adding a small ceramic cap in parallel with R<sub>1</sub> may further speed up the load transient responses and is thus recommended for applications with large load transient step requirements.

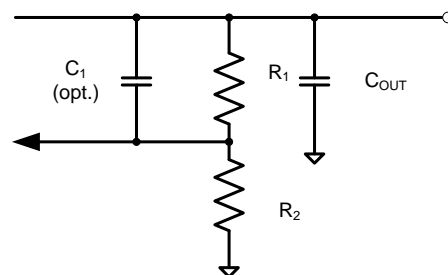



**PCB Layout Guide:**

For best performance of the SA21345A, the following guidelines must be strictly followed:

1. Keep all power trace as short and wide as possible. And it is desirable to use 2-layer or 4-layer board for thermal performance and better

capability of current flow.

2. Place input/output capacitor close to the IC for better transient performance.

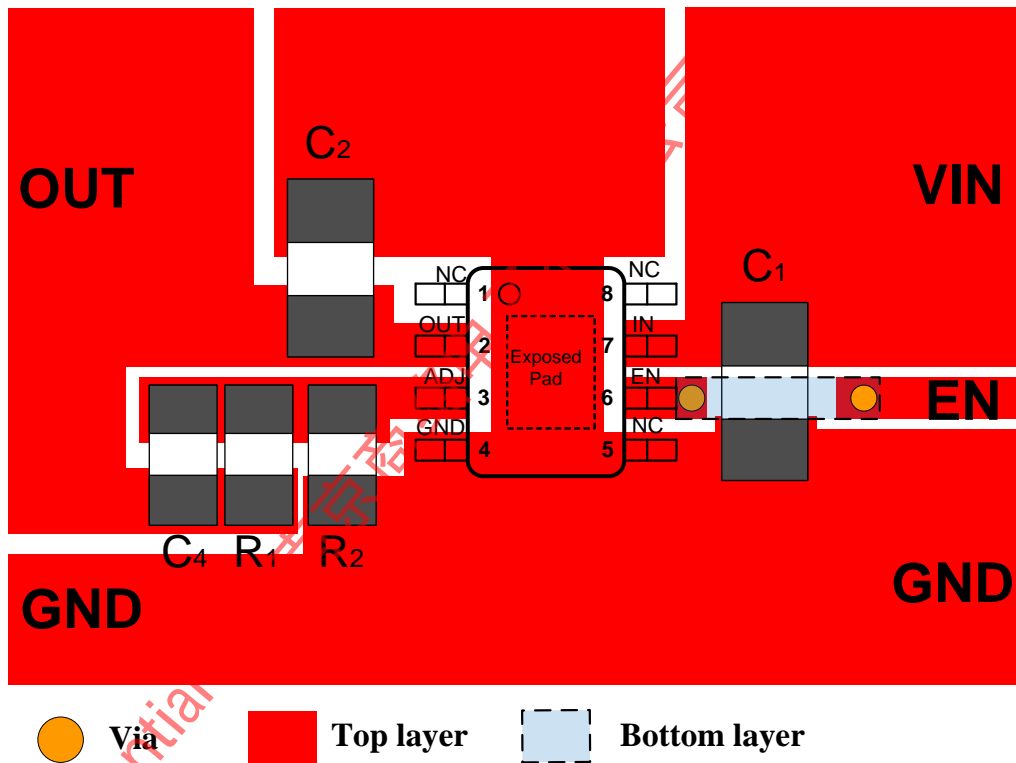
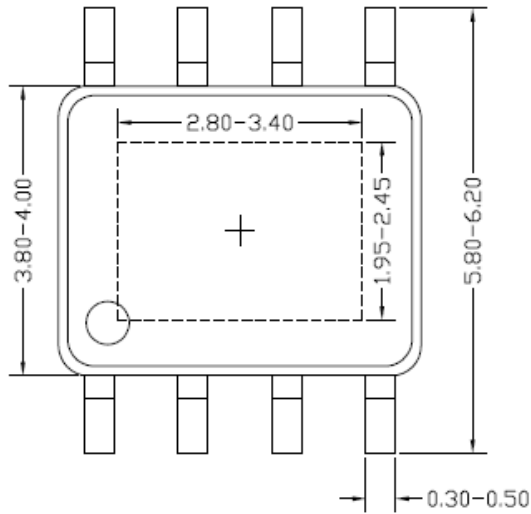
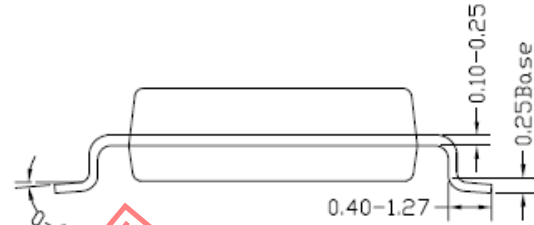

Figure4. PCB Layout Suggestion

SO8E Package Outline & PCB layout



Top view



Side view

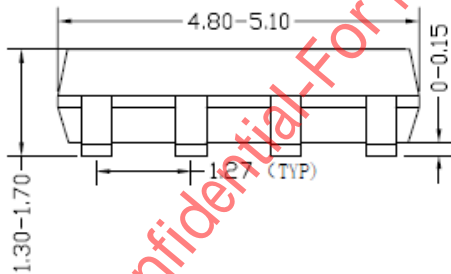

Front view

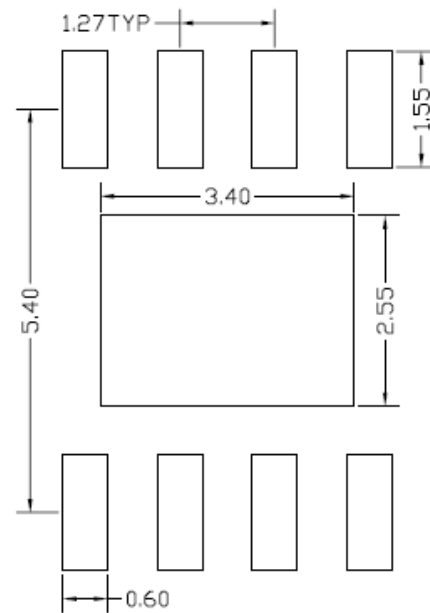

Recommended PCB layout  
(Reference Only)

Notes: All dimension in millimeter and exclude mold flash & metal burr.

## Taping & Reel Specification

### 1. Taping orientation

SO8E

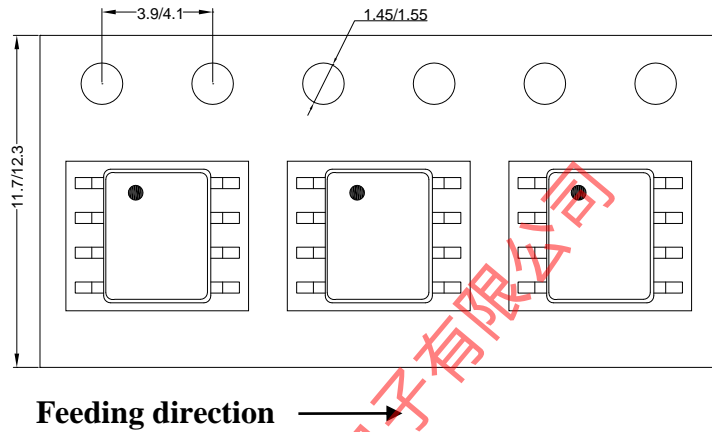

### 2. Carrier Tape & Reel specification for packages

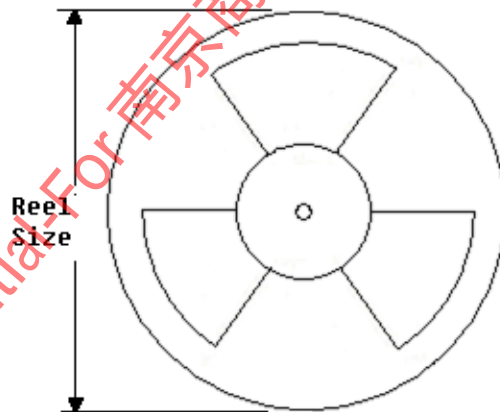

Package type	Tape width (mm)	Pocket pitch(mm)	Reel size (Inch)	Trailer length(mm)	Leader length (mm)	Qty per reel
SO8E	12	8	13"	400	400	2500

### 3. Others: NA

## Revision History

The revision history provided is for informational purpose only and is believed to be accurate, however, not warranted. Please make sure that you have the latest revision.

<b>Date</b>	<b>Revision</b>	<b>Change</b>
Nov.30, 2020	Revision 0.9	Initial Release

Silergy Confidential-For 南京商络电子有限公司

**IMPORTANT NOTICE**

- 1. Right to make changes.** Silergy and its subsidiaries (hereafter Silergy) reserve the right to change any information published in this document, including but not limited to circuitry, specification and/or product design, manufacturing or descriptions, at any time and without notice. This document supersedes and replaces all information supplied prior to the publication hereof. Buyers should obtain the latest relevant information before placing orders and should verify that such information is current and complete. All semiconductor products are sold subject to Silergy's standard terms and conditions of sale.
- 2. Applications.** Application examples that are described herein for any of these products are for illustrative purposes only. Silergy makes no representation or warranty that such applications will be suitable for the specified use without further testing or modification. Buyers are responsible for the design and operation of their applications and products using Silergy products. Silergy or its subsidiaries assume no liability for any application assistance or designs of customer products. It is customer's sole responsibility to determine whether the Silergy product is suitable and fit for the customer's applications and products planned. To minimize the risks associated with customer's products and applications, customer should provide adequate design and operating safeguards. Customer represents and agrees that it has all the necessary expertise to create and implement safeguards which anticipate dangerous consequences of failures, monitor failures and their consequences, lessen the likelihood of failures that might cause harm and take appropriate remedial actions. Silergy assumes no liability related to any default, damage, costs or problem in the customer's applications or products, or the application or use by customer's third-party buyers. Customer will fully indemnify Silergy, its subsidiaries, and their representatives against any damages arising out of the use of any Silergy components in safety-critical applications. It is also buyers' sole responsibility to warrant and guarantee that any intellectual property rights of a third party are not infringed upon when integrating Silergy products into any application. Silergy assumes no responsibility for any said applications or for any use of any circuitry other than circuitry entirely embodied in a Silergy product.
- 3. Limited warranty and liability.** Information furnished by Silergy in this document is believed to be accurate and reliable. However, Silergy makes no representation or warranty, expressed or implied, as to the accuracy or completeness of such information and shall have no liability for the consequences of use of such information. In no event shall Silergy be liable for any indirect, incidental, punitive, special or consequential damages, including but not limited to lost profits, lost savings, business interruption, costs related to the removal or replacement of any products or rework charges, whether or not such damages are based on tort or negligence, warranty, breach of contract or any other legal theory. Notwithstanding any damages that customer might incur for any reason whatsoever, Silergy's aggregate and cumulative liability towards customer for the products described herein shall be limited in accordance with the Standard Terms and Conditions of Sale of Silergy.
- 4. Suitability for use.** Customer acknowledges and agrees that it is solely responsible for compliance with all legal, regulatory and safety-related requirements concerning its products, and any use of Silergy components in its applications, notwithstanding any applications-related information or support that may be provided by Silergy. Silergy products are not designed, authorized or warranted to be suitable for use in life support, life-critical or safety-critical systems or equipment, nor in applications where failure or malfunction of an Silergy product can reasonably be expected to result in personal injury, death or severe property or environmental damage. Silergy assumes no liability for inclusion and/or use of Silergy products in such equipment or applications and therefore such inclusion and/or use is at the customer's own risk.
- 5. Terms and conditions of commercial sale.** Silergy products are sold subject to the standard terms and conditions of commercial sale, as published at <http://www.silergy.com/stdterms>, unless otherwise agreed in a valid written individual agreement specifically agreed to in writing by an authorized officer of Silergy. In case an individual agreement is concluded only the terms and conditions of the respective agreement shall apply. Silergy hereby expressly objects to and denies the application of any customer's general terms and conditions with regard to the purchase of Silergy products by the customer.
- 6. No offer to sell or license.** Nothing in this document may be interpreted or construed as an offer to sell products that is open for acceptance or the grant, conveyance or implication of any license under any copyrights, patents or other industrial or intellectual property rights. Silergy makes no representation or warranty that any license, either express or implied, is granted under any patent right, copyright, mask work right, or other intellectual property right. Information published by Silergy regarding third-party products or services does not constitute a license to use such products or services or a warranty or endorsement thereof. Use of such information may require a license from a third party under the patents or other intellectual property of the third party, or a license from Silergy under the patents or other intellectual property of Silergy.

For more information, please visit: [www.silergy.com](http://www.silergy.com)

©2020 Silergy Corp.

**All Rights Reserved.**