



SGM8478-1C

High Voltage, High Precision, Low Noise, Over the Rail Difference Amplifier

GENERAL DESCRIPTION

The SGM8478-1C is a low noise, high precision difference amplifier which can operate from 4.5V to 36V single supply. The device provides rail-to-rail output operation. Its input common mode voltage range covers up to $(+V_S) + 1V$. The wide input voltage range makes this device suitable for current sensing applications.

The SGM8478-1C offers a $16\mu V$ maximum input offset voltage. Meanwhile, the device features high linearity and high accuracy. The combination of these characteristics makes the SGM8478-1C a good choice for temperature measurements, pressure and position sensors, strain gauge amplifiers and medical instrumentation, or any other 4.5V to 36V applications requiring precision and long-term stability.

The SGM8478-1C saves external components by integrated matched resistors in differential applications. The gain of SGM8478-1C is 50V/V.

The SGM8478-1C is available in Green SOIC-8 and TDFN-3×3-8L packages. It operates over an ambient temperature range of $-40^{\circ}C$ to $+125^{\circ}C$.

FEATURES

- **Low Offset Voltage: $16\mu V$ (MAX)**
- **Input Signal Range:**
 $(-V_S) - 0.1V$ to $(+V_S) + 1V$ for Dual Power Supplies
 $GND - 0.1V$ to $(+V_S) + 1V$ for Single Power Supply
- **Gain: 50V/V**
- **PSRR: $0.05\mu V/V$ (TYP)**
- **CMRR: 106dB (TYP)**
- **0.1Hz to 10Hz Noise: $0.75\mu V_{P-P}$**
- **Input Voltage Noise Density: $39nV/\sqrt{Hz}$ at 1kHz**
- **-3dB Bandwidth: 230kHz**
- **Rail-to-Rail Output**
- **Wide Supply Voltage Range: 4.5V to 36V**
- **Supply Current: 1.55mA (TYP)**
- **Integrated Matched Resistors for Differential Applications**
- **$-40^{\circ}C$ to $+125^{\circ}C$ Operating Temperature Range**
- **Available in Green SOIC-8 and TDFN-3×3-8L Packages**

APPLICATIONS

Pressure Sensors
Temperature Measurements
Precision Current Sensing
Electronic Scales
Strain Gauge Amplifiers
Handheld Test Equipment
Thermocouple Amplifiers
Medical Instrumentation

High Voltage, High Precision, Low Noise, Over the Rail Difference Amplifier

SGM8478-1C

PACKAGE/ORDERING INFORMATION

MODEL	PACKAGE DESCRIPTION	SPECIFIED TEMPERATURE RANGE	ORDERING NUMBER	PACKAGE MARKING	PACKING OPTION
SGM8478-1C (Gain = 50)	SOIC-8	-40°C to +125°C	SGM8478-1CXS8G/TR	SGM 84781CXS8 XXXXX	Tape and Reel, 2500
	TDFN-3x3-8L	-40°C to +125°C	SGM8478-1CXTDB8G/TR	SGM 84781DB XXXXX	Tape and Reel, 4000

MARKING INFORMATION

NOTE: XXXXX = Date Code and Vendor Code.

XXXXX

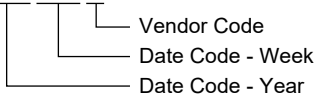

Green (RoHS & HSF): SG Micro Corp defines "Green" to mean Pb-Free (RoHS compatible) and free of halogen substances. If you have additional comments or questions, please contact your SGMICRO representative directly.

ABSOLUTE MAXIMUM RATINGS

Supply Voltage 40V
 Input Voltage Range (-Vs) -0.3V to (+Vs) + 1V
 Junction Temperature +150°C
 Storage Temperature Range -65°C to +150°C
 Lead Temperature (Soldering, 10s) +260°C
 ESD Susceptibility
 HBM 5000V
 CDM 1000V

RECOMMENDED OPERATING CONDITIONS

Operating Voltage Range 4.5V to 36V
 Operating Temperature Range -40°C to +125°C

OVERSTRESS CAUTION

Stresses beyond those listed in Absolute Maximum Ratings may cause permanent damage to the device. Exposure to absolute maximum rating conditions for extended periods may affect reliability. Functional operation of the device at any

conditions beyond those indicated in the Recommended Operating Conditions section is not implied.

ESD SENSITIVITY CAUTION

This integrated circuit can be damaged if ESD protections are not considered carefully. SGMICRO recommends that all integrated circuits be handled with appropriate precautions. Failure to observe proper handling and installation procedures can cause damage. ESD damage can range from subtle performance degradation to complete device failure. Precision integrated circuits may be more susceptible to damage because even small parametric changes could cause the device not to meet the published specifications.

DISCLAIMER

SG Micro Corp reserves the right to make any change in circuit design, or specifications without prior notice.

PIN CONFIGURATIONS

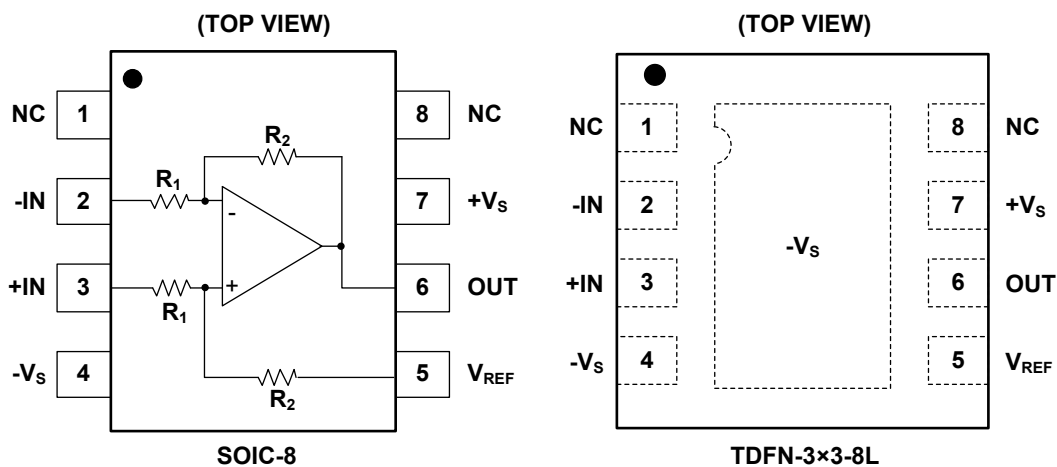

PIN DESCRIPTION

PIN		NAME	FUNCTION
SOIC-8	TDFN-3x3-8L		
1, 8	1, 8	NC	No Connection.
2	2	-IN	Inverting Input.
3	3	+IN	Non-Inverting Input.
4	4	-Vs	Negative Power Supply.
5	5	VREF	Reference Voltage Terminal.
6	6	OUT	Output of Amplifier.
7	7	+Vs	Positive Power Supply.
-	Exposed Pad	-Vs	Exposed pad should be soldered to PCB board and connected to -Vs.

High Voltage, High Precision, Low Noise, Over the Rail Difference Amplifier

SGM8478-1C

ELECTRICAL CHARACTERISTICS

(At $T_A = +25^\circ\text{C}$, $+V_S = 4.5\text{V}$ to 36V , $-V_S = 0\text{V}$, $V_{CM} = V_{REF} = +V_S/2$ and $R_L = 10\text{k}\Omega$, Full = -40°C to $+125^\circ\text{C}$, unless otherwise noted.)

PARAMETER	CONDITIONS	TEMP	MIN	TYP	MAX	UNITS
Input Characteristics						
Input Offset Voltage (V_{OS})	$V_S = 4.5\text{V}$ to 36V	$+25^\circ\text{C}$		5	16	μV
		Full			40	
Input Offset Voltage Drift ($\Delta V_{OS}/\Delta T$)		Full		0.14		$\mu\text{V}/^\circ\text{C}$
Input Common Mode Voltage Range (V_{CM})		Full	$(-V_S) - 0.1$		$(+V_S) + 1$	V
Common Mode Rejection Ratio (CMRR) ⁽¹⁾	$(-V_S) - 0.1\text{V} < V_{CM} < (+V_S) + 1\text{V}$	$+25^\circ\text{C}$	92	106		dB
		Full	89			
Output Characteristics						
Output Voltage Swing from Rail	$V_S = 36\text{V}$, $R_L = 10\text{k}\Omega$	$+25^\circ\text{C}$		195	270	mV
		Full			320	
Output Short-Circuit Current (I_{SC})	$V_S = 4.5\text{V}$	Full	9	19		mA
	$V_S = 36\text{V}$		37	64		
Power Supply						
Specified Voltage Range (V_S)		Full	4.5		36	V
Power Supply Rejection Ratio (PSRR) ⁽¹⁾	$V_S = 4.5\text{V}$ to 36V	$+25^\circ\text{C}$		0.05	0.3	$\mu\text{V}/\text{V}$
		Full			0.45	
Quiescent Current (I_Q)	$V_S = 4.5\text{V}$ to 36V	$+25^\circ\text{C}$		1.55	2.1	mA
		Full			2.4	
Dynamic Performance						
-3dB Bandwidth	$C_L = 25\text{pF}$	$+25^\circ\text{C}$		230		kHz
Slew Rate (SR)	$V_S = 30\text{V}$, $V_{OUT} = 4\text{V}_{P-P}$	$+25^\circ\text{C}$		2.1		$\text{V}/\mu\text{s}$
Noise						
Input Voltage Noise ⁽¹⁾	$f = 0.1\text{Hz}$ to 10Hz	$+25^\circ\text{C}$		0.75		μV_{P-P}
Input Voltage Noise Density (e_n) ⁽¹⁾	$f = 1\text{kHz}$	$+25^\circ\text{C}$		39		$\text{nV}/\sqrt{\text{Hz}}$
Gain						
Gain Error	$V_S = 30\text{V}$, $-9\text{V} \leq V_{OUT} \leq 9\text{V}$	$+25^\circ\text{C}$		0.01	0.1	%
Gain Temperature Coefficient	$V_S = 30\text{V}$, $-9\text{V} \leq V_{OUT} \leq 9\text{V}$	$+25^\circ\text{C}$		0.15		$\text{ppm}/^\circ\text{C}$

NOTE: 1. Referred to input.

SGM8478-1C High Voltage, High Precision, Low Noise, Over the Rail Difference Amplifier

TYPICAL PERFORMANCE CHARACTERISTICS

At $T_A = +25^\circ\text{C}$, $V_S = 30\text{V}$, unless otherwise noted.

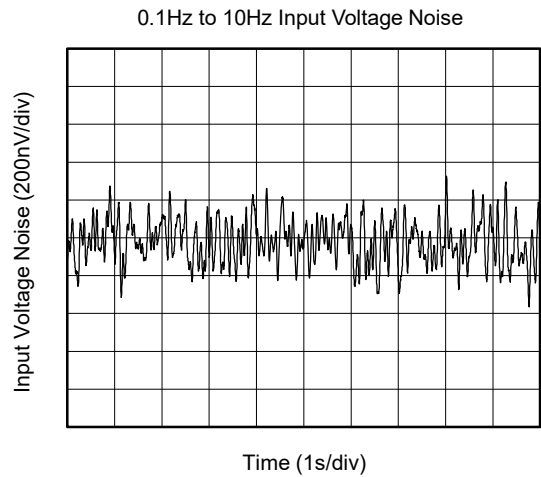
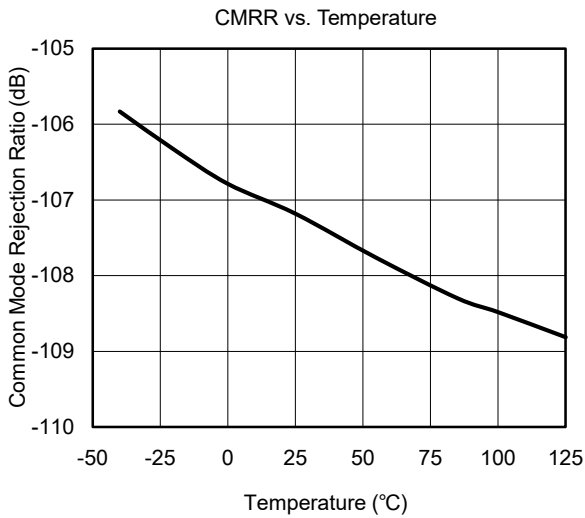
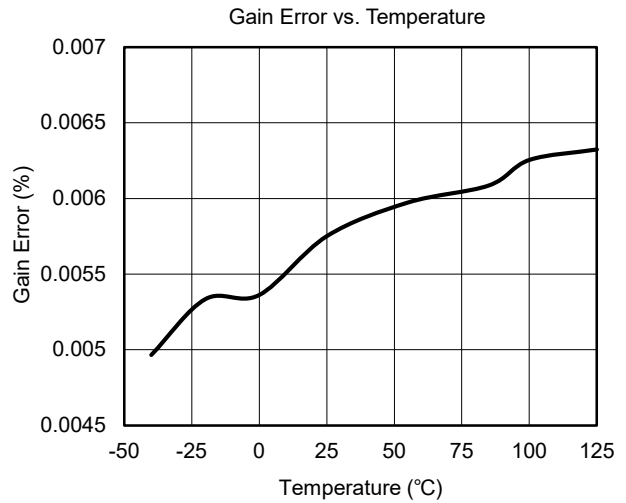
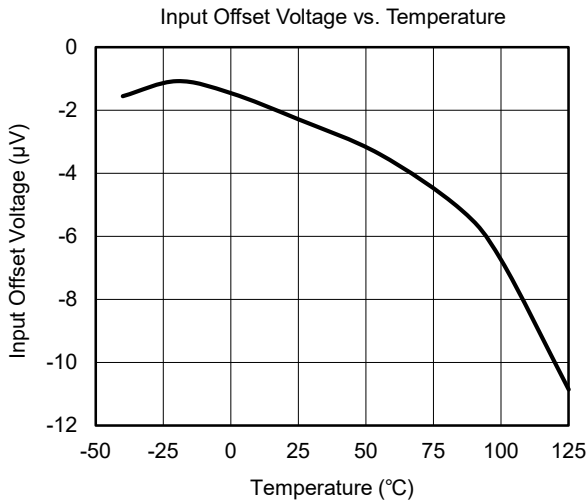
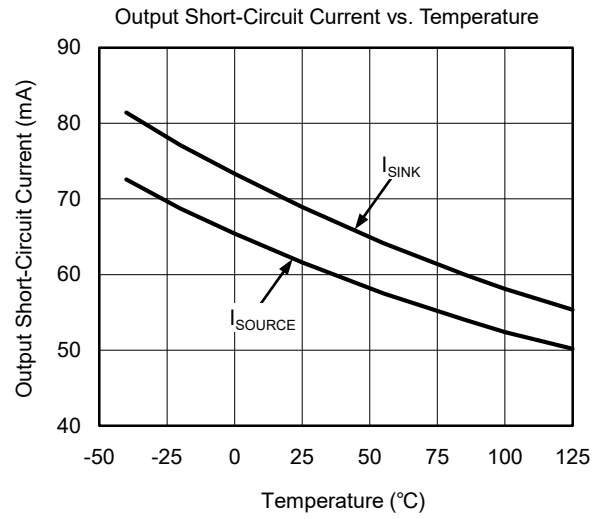
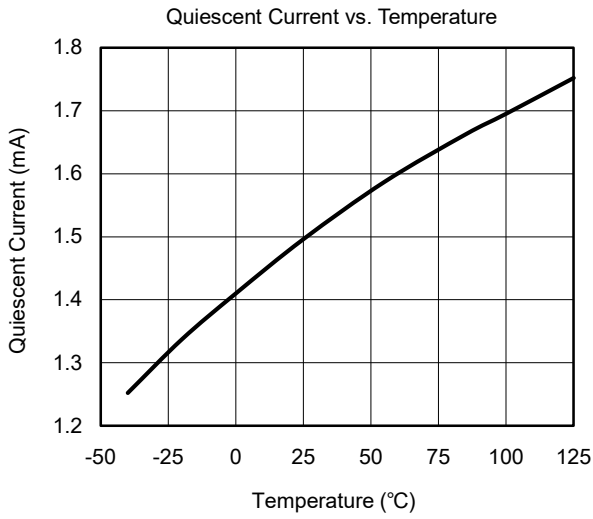

TYPICAL PERFORMANCE CHARACTERISTICS (continued)

At $T_A = +25^\circ\text{C}$, $V_S = 30\text{V}$, unless otherwise noted.

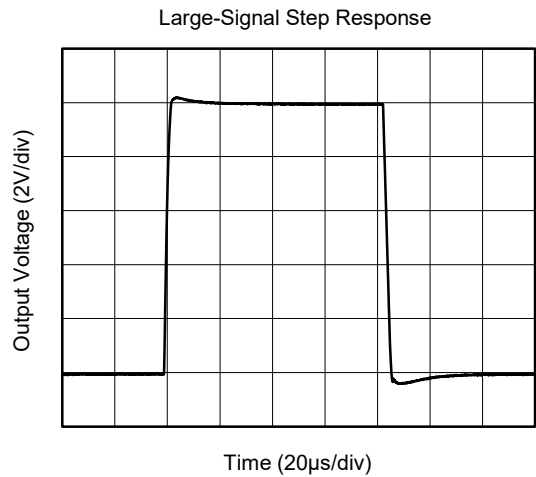
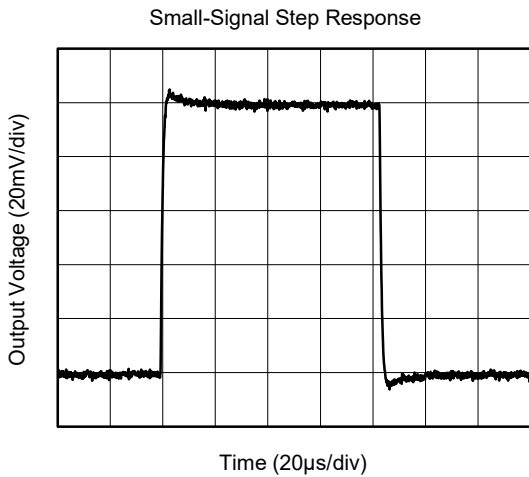
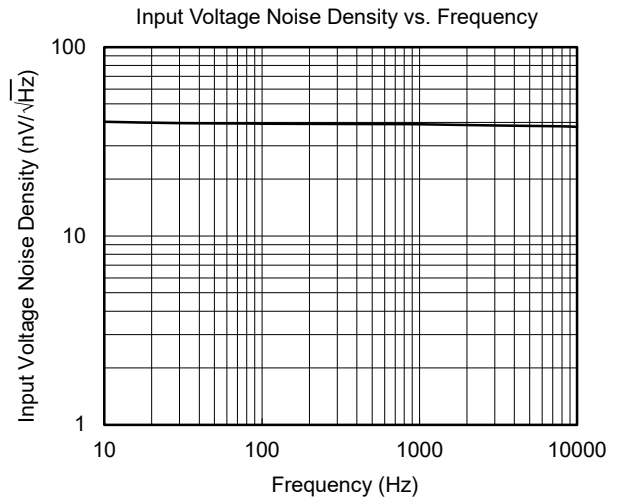
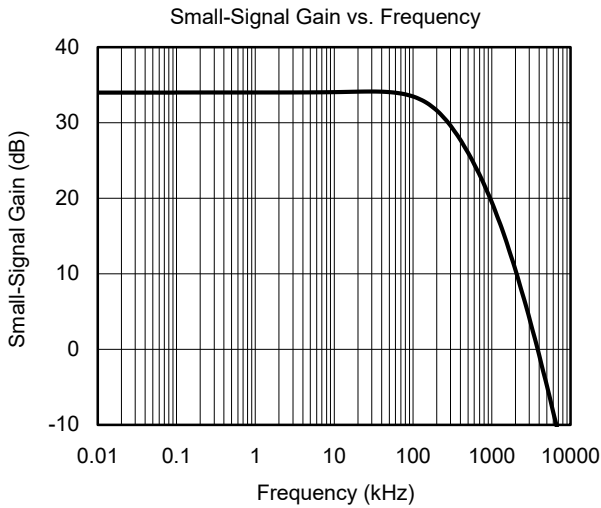
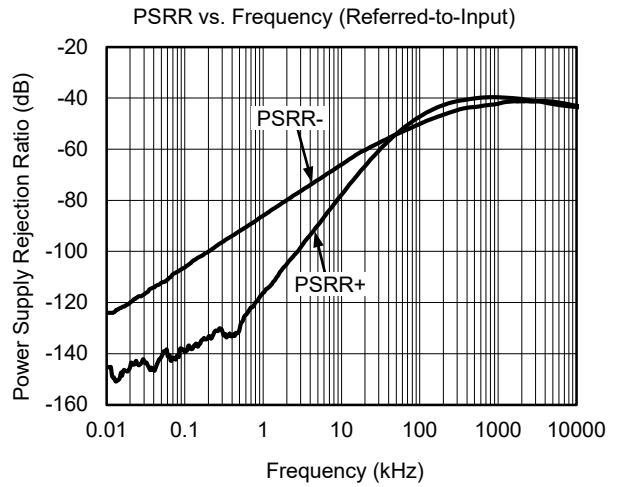
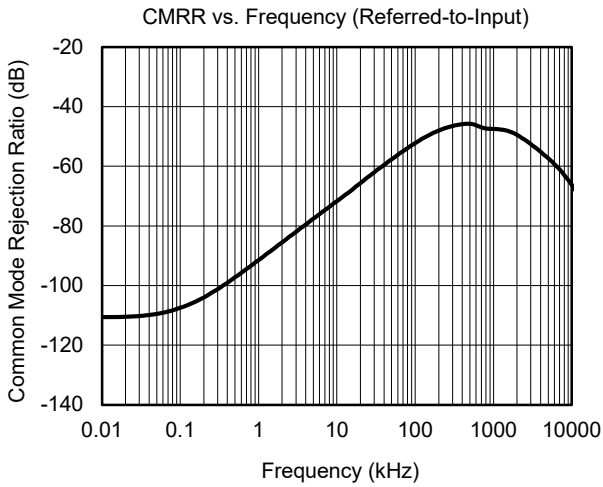

TYPICAL PERFORMANCE CHARACTERISTICS (continued)

At $T_A = +25^\circ\text{C}$, $V_S = 30\text{V}$, unless otherwise noted.

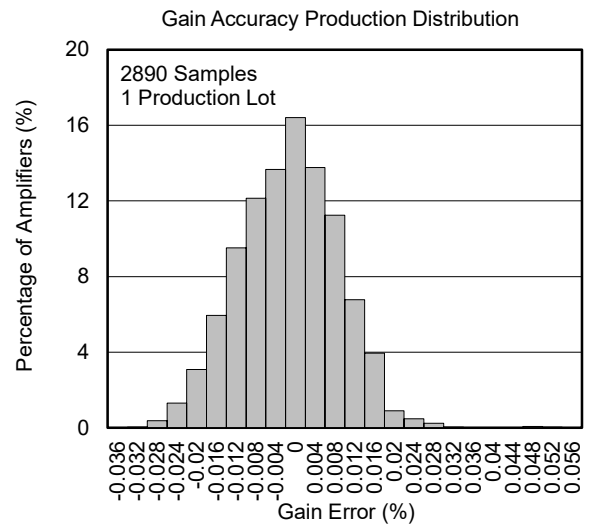
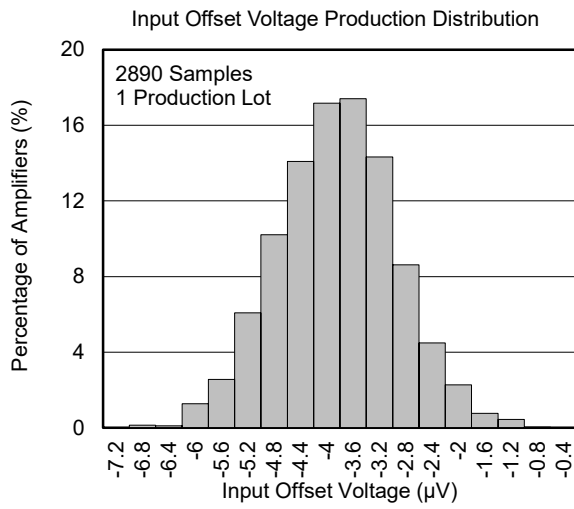

REVISION HISTORY

NOTE: Page numbers for previous revisions may differ from page numbers in the current version.

Changes from Original (JUNE 2019) to REV.A	Page
Changed from product preview to production data.....	All

PACKAGE OUTLINE DIMENSIONS

SOIC-8

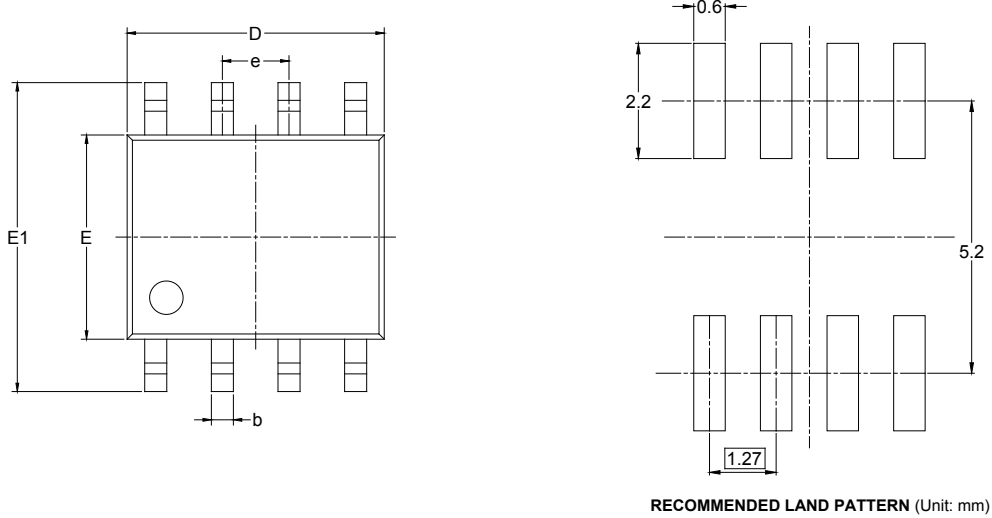

Symbol	Dimensions In Millimeters		Dimensions In Inches	
	MIN	MAX	MIN	MAX
A	1.350	1.750	0.053	0.069
A1	0.100	0.250	0.004	0.010
A2	1.350	1.550	0.053	0.061
b	0.330	0.510	0.013	0.020
c	0.170	0.250	0.006	0.010
D	4.700	5.100	0.185	0.200
E	3.800	4.000	0.150	0.157
E1	5.800	6.200	0.228	0.244
e	1.27 BSC		0.050 BSC	
L	0.400	1.270	0.016	0.050
θ	0°	8°	0°	8°

PACKAGE OUTLINE DIMENSIONS

TDFN-3x3-8L

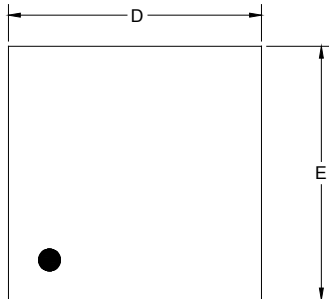

TOP VIEW

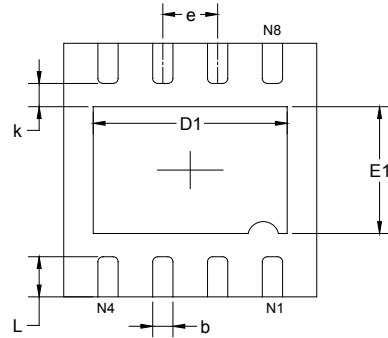

BOTTOM VIEW

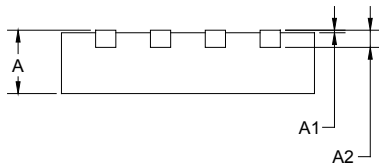

SIDE VIEW

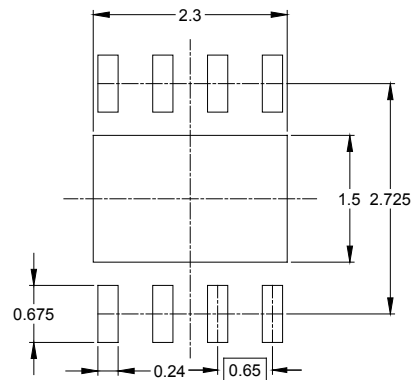

RECOMMENDED LAND PATTERN (Unit: mm)

Symbol	Dimensions In Millimeters		Dimensions In Inches	
	MIN	MAX	MIN	MAX
A	0.700	0.800	0.028	0.031
A1	0.000	0.050	0.000	0.002
A2	0.203 REF		0.008 REF	
D	2.900	3.100	0.114	0.122
D1	2.200	2.400	0.087	0.094
E	2.900	3.100	0.114	0.122
E1	1.400	1.600	0.055	0.063
k	0.200 MIN		0.008 MIN	
b	0.180	0.300	0.007	0.012
e	0.650 TYP		0.026 TYP	
L	0.375	0.575	0.015	0.023

TAPE AND REEL INFORMATION

REEL DIMENSIONS



TAPE DIMENSIONS



NOTE: The picture is only for reference. Please make the object as the standard.

KEY PARAMETER LIST OF TAPE AND REEL

Package Type	Reel Diameter	Reel Width W1 (mm)	A0 (mm)	B0 (mm)	K0 (mm)	P0 (mm)	P1 (mm)	P2 (mm)	W (mm)	Pin1 Quadrant
SOIC-8	13"	12.4	6.40	5.40	2.10	4.0	8.0	2.0	12.0	Q1
TDFN-3×3-8L	13"	12.4	3.35	3.35	1.13	4.0	8.0	2.0	12.0	Q1

DD0001

PACKAGE INFORMATION

CARTON BOX DIMENSIONS



NOTE: The picture is only for reference. Please make the object as the standard.

KEY PARAMETER LIST OF CARTON BOX

Reel Type	Length (mm)	Width (mm)	Height (mm)	Pizza/Carton
13"	386	280	370	5

DD0002