

Square Body Fuses



Introduction

Square Body Contents	Page
Application Information	115-116

Volts (IEC/UL)	Size	Class	Fuse Style	Page	
690/700	000,00	aR	DIN 43 653	117-119	
		aR	Flush End Contact	117-119	
		aR	DIN 43 620	120-121	
	1*, 1, 2, 3	aR	DIN 43 653	122-123	
			Flush End Contact	124-125	
		aR	US Style	126-127	
		aR	French Style	128-129	
		aR	Fuse Curves	130-131	
		1*, 2, 3	aR	DIN 43 620	132-134
		4	aR	Flush End Contact	135-136
23, 24	aR	Flush End Contact	137-139		
1000	00, 1, 2, 3	aR	DIN 43 620	140-143	
		aR	DIN 43 653	144-145	
	1*, 1, 2, 3	aR	DIN 43 653	146-147	
		aR	Flush End Contact	148-149	
		aR	US Style	150-151	
		aR	Fuse Curves	152-153	
	4	aR	Flush End Contact	154-156	
	24	aR	Flush End Contact	157-159	
	1250/1300	1*, 1, 2, 3	aR	DIN 43 653	160-161
			aR	Flush End Contact	162-163
aR			US Style	164-165	
aR		Fuse Curves	166-167		
4		aR	Flush End Contact	168-170	
23		aR	Flush End Contact	171-172	
1000-2000 DC Fuses	5	aR	Flush End Contact	173	
				174-184	

Accessories	Page
Indicator System	185
Fuse Bases	186

Square Body Fuse Ranges

Amps	Volts	AC	DC
10-7500	690	X	—
50-1400	1250	X	—

General Information

Designed and tested to:

- IEC 60269: Part 4
- UL Recognized

Cooper Bussmann offers a complete range of square body style fuses and accessories. Their unique design and construction provide:

- Minimal energy let-through (I²t)
- Low operating temperature
- Low watts loss

Square body style fuses are a very attractive solution for high power applications which require a compact design with superior performance. The construction and design of square body style fuses make it easy for Cooper Bussmann to manufacture custom products. Our cataloged offering provides only a sample of the wide variety of product which is available.

Each square body style fuse is available with a number of different end fittings. Options include:

- DIN 43 653
- DIN 43 620
- Flush End (Metric/US)
- French Style
- US Style

Voltage Rating

All Cooper Bussmann square body style fuses are tested to IEC 60269: Part 4. This standard requires a test voltage which is 5% higher than the rated voltage. In North America, fuses are required to clear only their rated voltage.

Accessories

Square Body style fuses are available with three different open fuse indicator systems. Options include visual indication and indication utilizing a microswitch. Fuse blocks are also available for most applications.

Square Body Applications

Maximum Permissible Load Current

The rated current value of Cooper Bussmann fuses is based on the ambient temperature in the space immediately below the fuse of 20°C. The following graph gives correction factors (k) for a range of temperatures (-40°C to +80°C). Maximum permissible continuous load currents can be calculated by applying the following formula:

$$I_b \leq I_n \approx k \approx (1 + 0.05 V) \times K_b$$

where

I_b = Maximum permissible continuous load current

I_n = Rated current of fuse

k = Temperature correction factor

v = Velocity of cooling air in m/s (max. 5 m/s).

K_b = Fuse load constant 1.0

Temperature Correction Curve

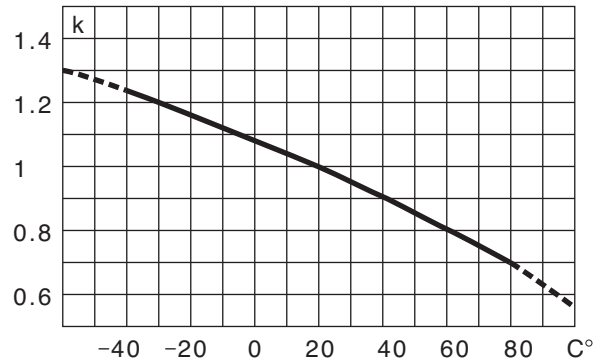

The maximum permissible continuous load current I_b of a fuse can be checked empirically (i.e., by satisfying the formula below) by making simple voltage and temperature measurements under actual operating conditions after the fuse has been installed in its operating location and loaded at the calculated I_b value:

$$\frac{E_2}{E_1} \approx (0.92 + 0.004t) \leq N$$

where

E_1 = Voltage drop across fuse after 5 seconds

E_2 = Voltage drop across fuse after 2 hours

t = Air temperature at start of test (°C)

N = Constant

Fuse Rated Voltage (IEC) N

690	1.5
1250	1.6

Body Cross Section

Standard fuse program includes barrels with different cross sections.

Size	000	00	1	1	2	3	4
Maximum Cross-section (mm)	21 × 36	30 × 47	45 × 45	53 × 53	61 × 61	76 × 76	105 × 105

Square Body Applications

Example Application of Square Body High Speed Fuses Subject to Overload and Impulse Loading

Select a short-blade indicating fuse with indicator/adaptor to permit the use of a single-pole microswitch for remote indication and determine if the fuse selected will meet the following application parameters.

Application Parameters

Load Currents Expected

Load Type	Duration	Frequency of Occurrence	Amps
(1) Normal	Continuous	—	300A
(2) Overload	60 Seconds	Once Per Hour	500A
(3a) Overload	10 Seconds	2-3 Times Per Week	700A
(3b) Overload	20 Seconds (max.)	Once Per Month	
(4) Impulse	0.5 Seconds	Less Than Once Per Month	1100A

Voltage Data

(5) Voltage Applied to Fuse During Fault Conditions (+10%)	400V
--	------

Temperature Data

(6) Temperature Inside Cubicle in Which Fuse is Located (Natural Convection Cooling Only)	60°C
---	------

Thyristor Data

(7) Thyristor Peak Voltage Withstand	1000V
(8) Thyristor I ^t Withstand at 10 Milliseconds*	90,000A ² s

*Note: The I^t withstand of the thyristor may be given for other impulse durations (i.e., 1.5 ms, 3.5 ms, or 8.3 ms); however, the stated fuse I^t is valid for all impulse durations of 10 ms or less.

Application Procedure

Step	Procedure	Remarks
(1) Select a short-blade fuse to permit mounting of microswitch 170H0069	1.1 Taking into consideration only the continuous load current and ambient temperature, from Table on page 127 tentatively select fuse 170M3669 (400A, 690V).	—
(2) Determine I ^t (total clearing) at 440V.	2.1 See Table, page 127. Note I ^t is 105,000A ² s at rated voltage of 690V. 2.2 From the figure on page 126, note that correction factor K = 0.65. 2.3 I ^t _{440V} × K = I ^t _{690V} 105,000 × 0.65 = 68,250	OK
(3) Determine maximum arc voltage at 440V	3.1 From the figure on page 126, note that maximum voltage at 440V is 900V	OK
(4) Determine maximum permissible continuous load current I _b .	4.1 Per page 115 data, I _b = I _n × k × (1 + 0.05V) × K _p I _b = 400A × 0.8 × (1 + 0) × 1 I _b = 320A	—
(5) Plot a "line profile" showing the expected load and overload currents. Determine that overload and impulse load currents do not exceed their maximum permissible values.	5.0 Calculate I _{max} per Table, High Speed Fuse Application Guide page 16, for each overload and impulse load.	—
(Item 2)	5.1 I _{max} < 60% × I _t 500A < 60% × 950A 500A < 570A	OK
(Item 3a)	5.2 I _{max} < 60% × I _t 700A < 60% × 1360A 700A < 780A	OK
(Item 3b)	5.3 I _{max} < 70% × I _t 700A < 70% × 1150A 700A < 805A	OK
(Item 4)	5.4 I _{max} < 70% × I _t 1100A < 70% × 1800A 1100A < 1260A	OK

The tentatively selected fuse 170M3669 with microswitch 170H0069 meets all application parameters; no further selection would be necessary.

170M3669 (400A)

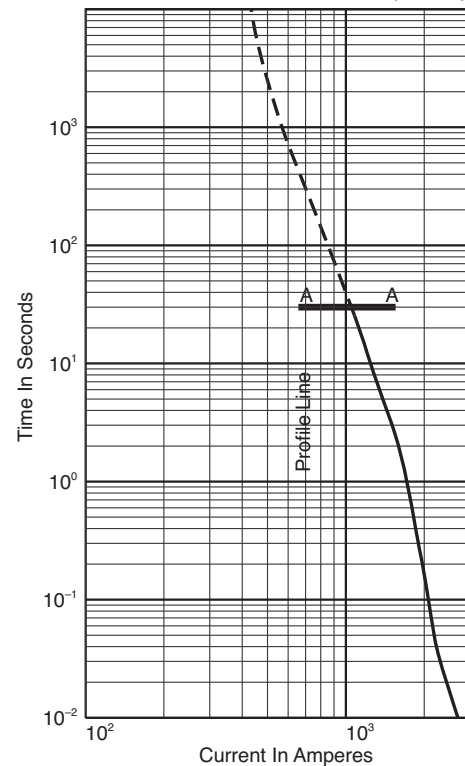

Calculation of Watt Loss

From the Table on page 127, watt loss at 400 amps is 60 watts. The continuous load current of 300A is 75% of rated current (400A). From page 126, the correction factor $K_p = 0.5$.

$$\begin{aligned} \text{Watt Loss } 75\% &= \text{Watt Loss } 100\% \times K_p \\ &= 60W \times 0.5 \\ &= 30 \text{ watts} \end{aligned}$$

Special Fuses

Other high speed fuses are available from Cooper Bussmann with voltage ratings of 380 to 10,000V and current ratings up to 10,000A in a single unit configuration. Fuses can be supplied with open fuse, "pin" indicators. Various types of microswitches are also available (see page 185).

Square Body DIN 43 653 — 690V/700V (IEC/UL): 10-400A

690V/700V (IEC/UL) 10-400A

Specifications

Description: Square body DIN 43-653 stud mount high speed fuses.

Dimensions: See dimensions illustration.

Ratings:

Volts: — 690Vac (IEC)
— 700Vac (UL)

Amps: — 10-400A

IR: — 200kA RMS Sym.

Agency Information: CE, Designed and tested to IEC 60269: Part 4, UL Recognized. UL Recognition/CSA Component Acceptance on Size 000.

Electrical Characteristics

Total Clearing I^2t

The total clearing I^2t at rated voltage and at power factor of 15% are given in the electrical characteristics. For other voltages, the clearing I^2t is found by multiplying by correction factor, K, given as a function of applied working voltage, E_g , (rms).

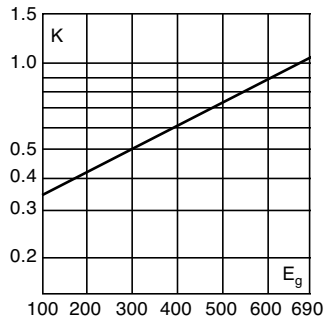

Dimensions (mm)

Type -U/80, -/80, -TN/80

Size	D	E	F	G	H	K
000	40	21	20	51	8	2
00	51	30	28	67	10	2

1mm = 0.0394" / 1" = 25.4mm

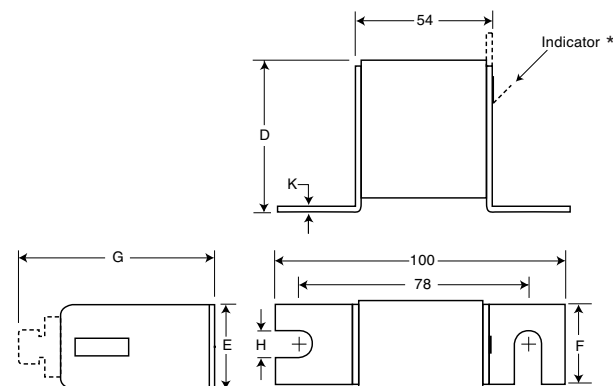

* Indication for Size 00 fuses is a red pin.



Arc Voltage

This curve gives the peak arc voltage, U_L , which may appear across the fuse during its operation as a function of the applied working voltage, E_g , (rms) at a power factor of 15%.

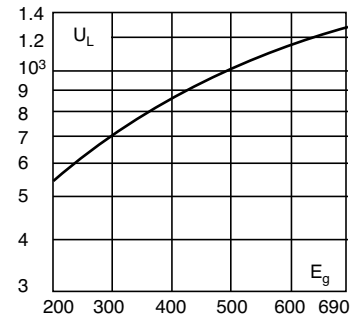

Power Losses

Watts loss at rated current is given in the electrical characteristics. The curve allows the calculation of the power losses at load currents lower than the rated current. The correction factor, K_p , is given as a function of the RMS load current, I_b , in % of the rated current.

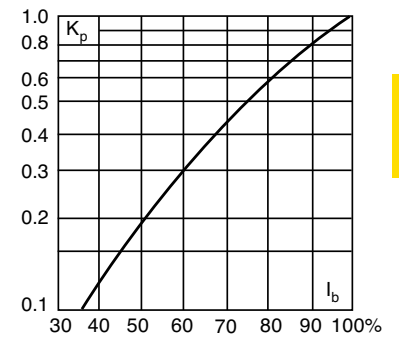

Features and Benefits

- Excellent DC performance
- Low arc voltage and low energy let-through (I^2t)
- Low watts loss
- Superior cycling capability

Typical Applications

- DC common bus
- DC drives
- Power converters/rectifiers
- Reduced voltage starters

For Other Voltage Ratings in This Body Style

- See page 144 (1000V)

Dimensions (mm)

Type 00B/60, 00BTN/60

1mm = 0.0394" / 1" = 25.4mm

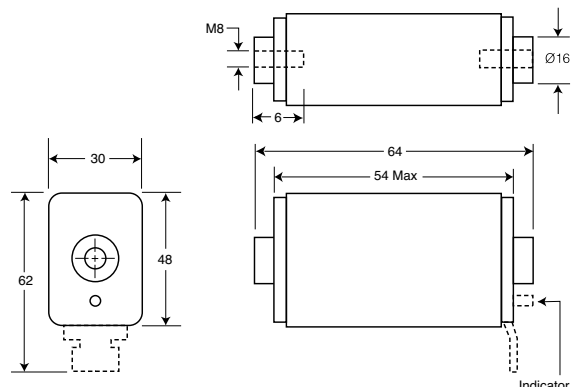

Square Body DIN 43 653 — 690V/700V (IEC/UL): 10-400A

Catalog Numbers

Catalog Numbers					Size	Electrical Characteristics			
-U/80 Without Indicator	-80 Visual Indicator	-TN/80 Type T Indicator for Micro	00B/60 Visual Indicator	00BTN/60 Type T Indicator for Micro		Rated Current RMS-Amps	Pt (A ² Sec)		Watts Loss
							Pre-arc	Clearing at 660V	
170M1308	170M1358	170M1408			10	3.8	25.5	3.0	
170M1309	170M1359	170M1409			16	7.2	48	5.5	
170M1310	170M1360	170M1410			20	11.5	78	7	
170M1311	170M1361	170M1411			25	19	130	9	
170M1312	170M1362	170M1412			32	40	270	10	
170M1313	170M1363	170M1413			40	69	460	12	
170M1314	170M1364	170M1414			50	115	770	15	
170M1315	170M1365	170M1415			63	215	1450	16	
170M1316	170M1366	170M1416			80	380	2550	19	
170M1317	170M1367	170M1417			100	695	4650	24	
170M1318	170M1368	170M1418			125	1200	8500	28	
170M1319	170M1369	170M1419			160	2300	16000	32	
170M1320	170M1370	170M1420			200	4200	28000	37	
170M1321	170M1371	170M1421			250	7750	51500	42	
170M1322	170M1372	170M1422			315	12000	80500	52	
	170M2608	170M2658	170M2708	170M2758		25	19	130	6
	170M2609	170M2659	170M2709	170M2759		32	28.5	195	7
	170M2610	170M2660	170M2710	170M2760		40	50	360	9
	170M2611	170M2661	170M2711	170M2761		50	95	640	10
	170M2612	170M2662	170M2712	170M2762		63	170	1200	12
	170M2613	170M2663	170M2713	170M2763		80	310	2100	15
	170M2614	170M2664	170M2714	170M2764	00	100	620	4150	20
	170M2615	170M2665	170M2715	170M2765		125	1000	6950	25
	170M2616	170M2666	170M2716	170M2766		160	1900	13000	30
	170M2617	170M2667	170M2717	170M2767		200	3400	23000	35
	170M2618	170M2668	170M2718	170M2768		250	6250	42000	45
	170M2619	170M2669	170M2719	170M2769		315	10000	68500	55
	170M2620	170M2670	170M2720	170M2770		350	13500	91500	60
	170M2621	170M2671	170M2721	170M2771		400	18000	125000	70

- Watts loss provided at rated current.
- Microswitch indicator ordered separately.
- See accessories on pages 185-186.
- For fuse curves see page 119.

Square Body Size 000, 00 — 690V/700V (IEC/UL): 10-400A

Size 000 — 10-315A: 690V

Time-Current Curve

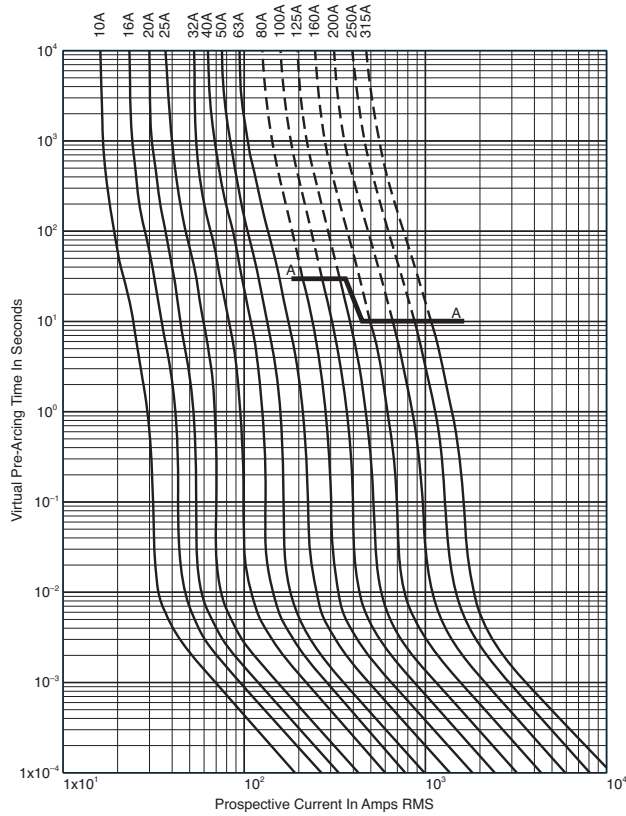

Size 00 — 25-400A: 690V

Time-Current Curve

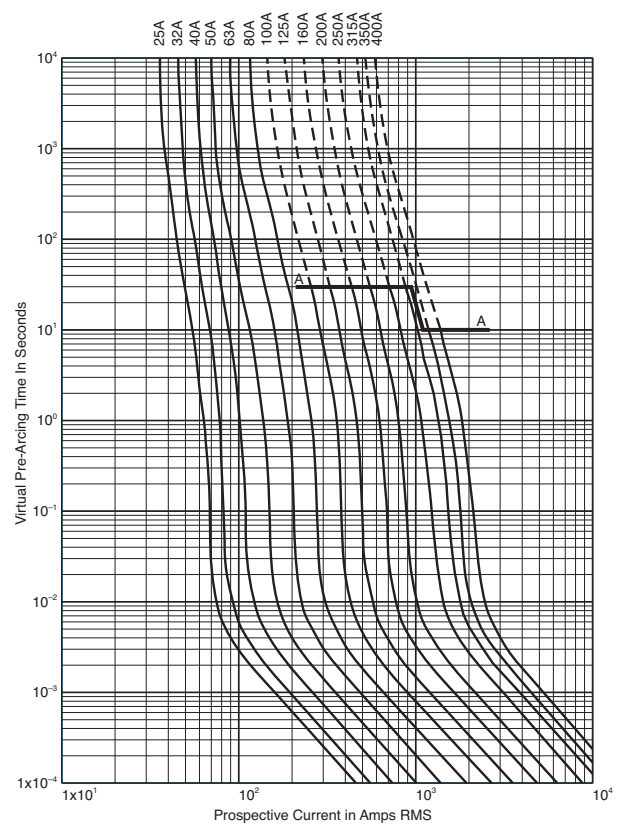

High Speed Fuses

Peak Let-Through Curve

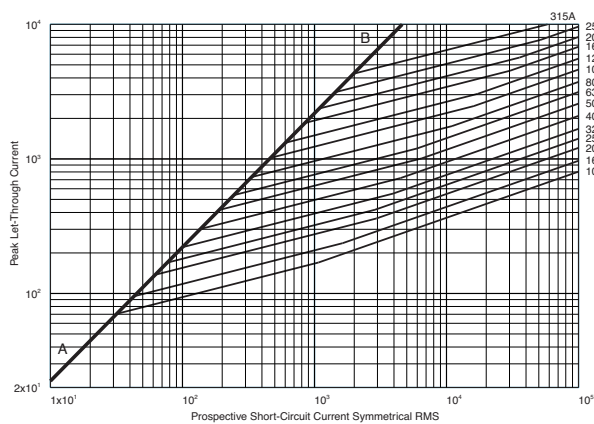

Peak Let-Through Curve

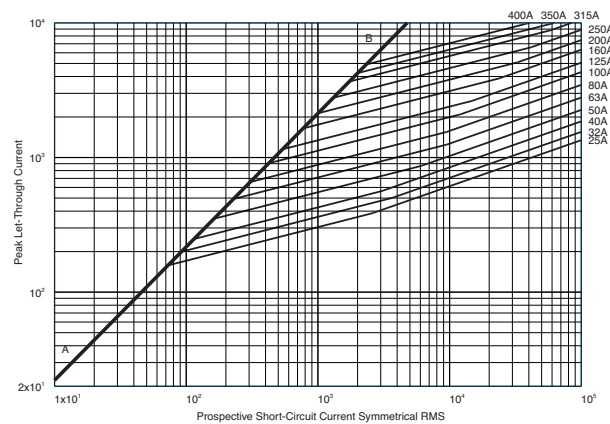

Data Sheet: 17056310

Data Sheet: 172056312

Square Body DIN 43 620 — 690V (IEC/UL): 10-315A

690V (IEC/UL) 10-315A

Specifications

Description: Square body DIN 43 620 blade style high speed fuses.

Dimensions: See dimensions illustration.

Ratings:

Volts: — 690Vac

Amps: — 10-315A

IR: — 200kA RMS Sym.

Agency Information: CE, Designed and tested to IEC 60269: Part 4, UL Recognized.

Electrical Characteristics

Total Clearing I^2t

The total clearing I^2t at rated voltage and at power factor of 15% are given in the electrical characteristics. For other voltages, the clearing I^2t is found by multiplying by correction factor, K, given as a function of applied working voltage, E_g , (rms).

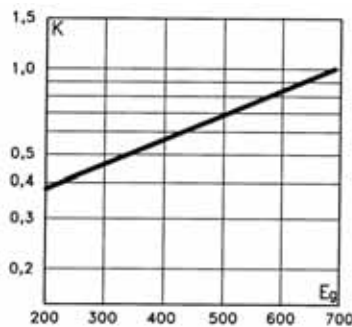

Arc Voltage

This curve gives the peak arc voltage, U_L , which may appear across the fuse during its operation as a function of the applied working voltage, E_g , (rms) at a power factor of 15%.

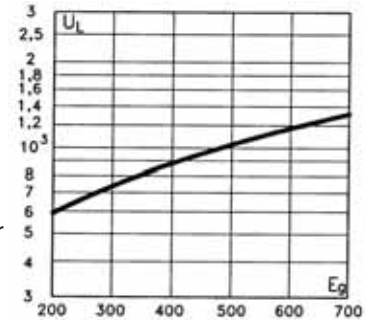

Power Losses

Watts loss at rated current is given in the electrical characteristics. The curve allows the calculation of the power losses at load currents lower than the rated current. The correction factor, K_p , is given as a function of the RMS load current, I_b , in % of the rated current.

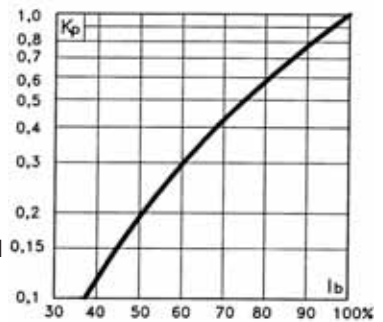

Features and Benefits

- Excellent DC performance
- Low arc voltage and low energy let-through (I^2t)
- Low watts loss
- Superior cycling capability

Typical Applications

- DC common bus
- DC drives
- Power converters/rectifiers
- Reduced voltage starters

Dimensions (mm)

DIN 000 Type T

1mm = 0.0394" / 1" = 25.4mm

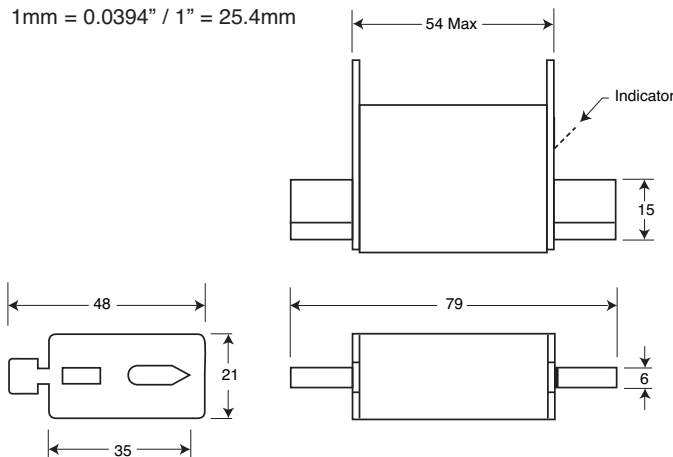

Square Body DIN 43 620 — 690V (IEC/UL): 10-315A

Catalog Numbers

Catalog Numbers DIN Type T Indicator for Micro	Size	Electrical Characteristics				
		Rated Current RMS-Amps	Pt (A ² Sec)		Watts Loss	
			Pre-arc	Clearing at 660V		
170M1558D	000	10	4	27	2.5	
170M1559D		16	7	51	4	
170M1560D		20	11.5	82.5	5	
170M1561D		25	19	140	6	
170M1562D		32	40	285	7	
170M1563D		40	65	490	8.5	
170M1564D		50	115	815	9.5	
170M1565D		63	215	1550	11.5	
170M1566D		80	380	2700	15	
170M1567D		100	695	4950	16.5	
170M1568D		125	1180	8250	21.5	
170M1569D		160	2300	16500	25	
170M1570D		200	4350	31000	29.5	
170M1571D		250	7900	56000	35.5	
170M1572D		00	315	12000	84500	45

- Watts loss provided at rated current.
- Microswitch indicator ordered separately. See accessories on pages 185-186.

Rated Current

The rated current of this fuse range has been given with copper conductors that have a current density of 1.3 A/mm² (IEC 60269-4). For conductor cross section according to IEC 60269-1, the fuses with a rated current higher than 125A must be derated. Please contact Cooper Bussmann for application assistance.

Size 000 — 10-315A: 690V

Time-Current Curve

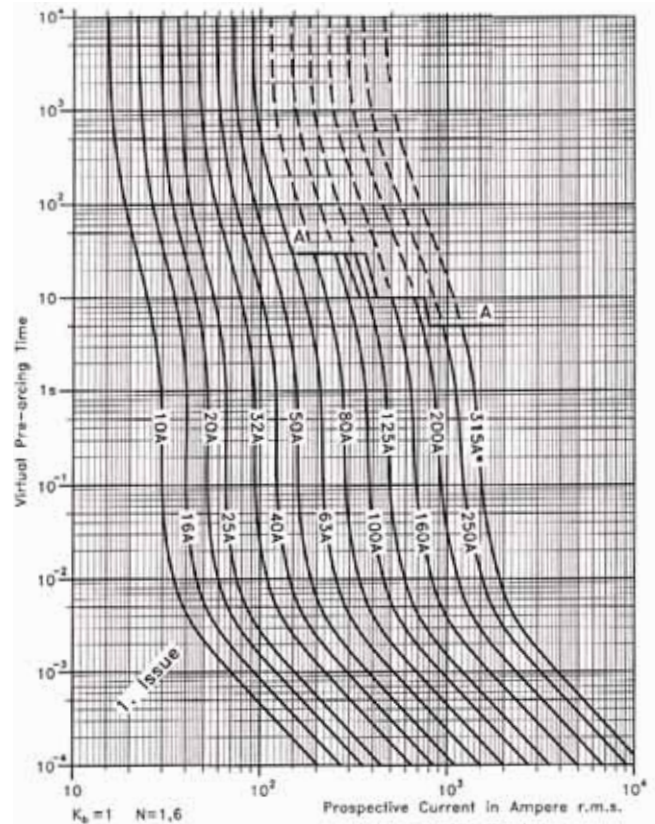

High Speed Fuses

Peak Let-Through Curve

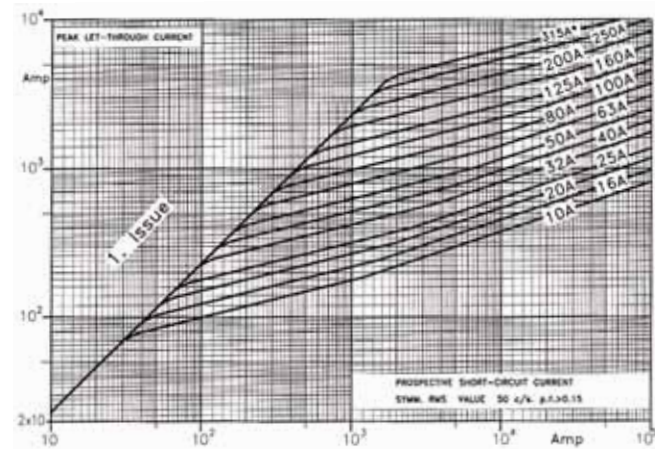

Data Sheet: 72056310

Square Body DIN 43 653 — 690V/700V (IEC/UL): 40-2000A

690V/700V (IEC/UL) 40-2000A

Specifications

Description: Square body DIN 43 653 stud-mount high speed fuses.

Dimensions: See dimensions illustration.

Ratings:

Volts: — 690Vac (IEC)
— 700Vac (UL)

Amps: — 40-2000A

IR: — 200kA RMS Sym.

Agency Information: CE, Designed and tested to IEC 60269: Part 4, UL Recognized. Consult Cooper Bussmann for UL Recognition/CSA Component Acceptance status.



Electrical Characteristics

Total Clearing I²t

The total clearing I²t at rated voltage and at power factor of 15% are given in the electrical characteristics. For other voltages, the clearing I²t is found by multiplying by correction factor, K, given as a function of applied working voltage, E_g, (rms).

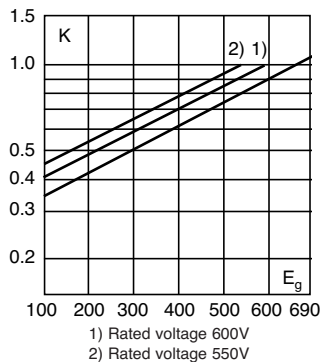

Dimensions (mm)

Size	A	B	B**	C	C**	D***	E	H
1*	50	104	134	78	108	58	45	22
1	50	108	138	78	108	66	53	25
2	50	108	138	78	108	75	61	25
3	51	109	139	78	108	90	76	30

**Valid for fuses type -/110, -TN/110.

***Microswitch.

1mm = 0.0394" / 1" = 25.4mm

Type -/80, -TN/80, -/110, -TN/110.

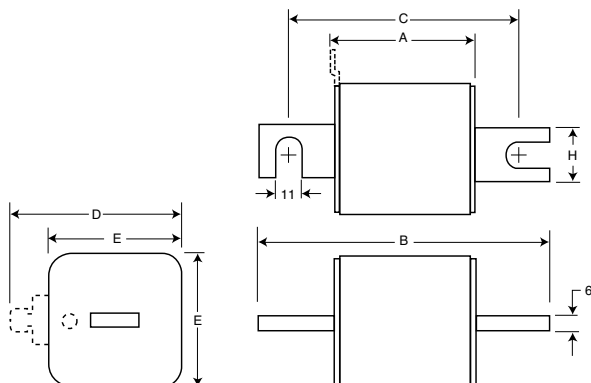

Arc Voltage

This curve gives the peak arc voltage, U_L, which may appear across the fuse during its operation as a function of the applied working voltage, E_g, (rms) at a power factor of 15%.

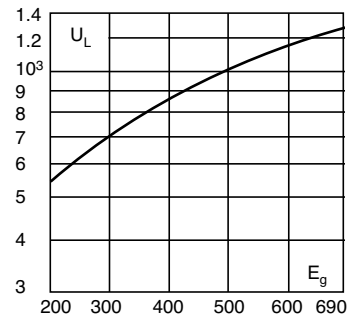

Power Losses

Watts loss at rated current is given in the electrical characteristics. The curve allows the calculation of the power losses at load currents lower than the rated current. The correction factor, K_p, is given as a function of the RMS load current, I_b, in % of the rated current.

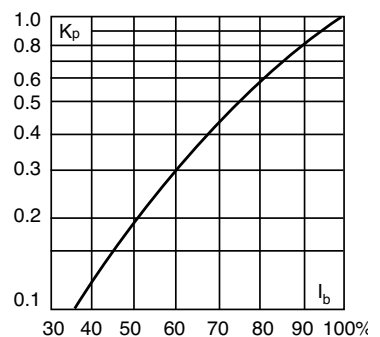

Features and Benefits

- Excellent DC performance
- Low arc voltage and low energy let-through (I²t)
- Low watts loss
- Superior cycling capability

Typical Applications

- DC common bus
- DC drives
- Power converters/rectifiers
- Reduced voltage starters

For Other Voltage Ratings in This Body Style

- See pages 146 (1000V) and 160 (1250V/1300V)

Type -KN/80, -KN/110

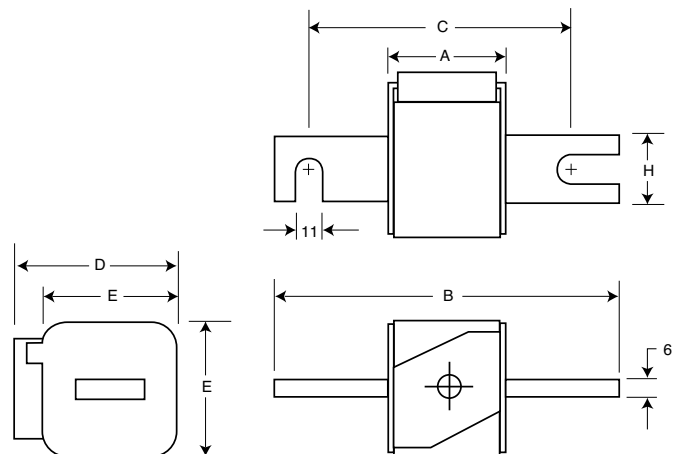

Square Body DIN 43 653 — 690V/700V (IEC/UL): 40-2000A

Catalog Numbers

Catalog Numbers						Size	Electrical Characteristics			
-/80 Visual Watts Indicator	-TN/80 Type T Indicator for Micro	-KN/80 Type K Indicator for Micro	-/110 Visual for Micro	-TN/110 Type T Indicator for Micro	-KN/110 Type K Indicator -KN/80		Rated RMS-Amps	Pt (A ² Sec)		Clearing Loss
								Current Pre-arc	at 660V	
170M3008	170M3058	170M3108	170M3158	170M3208	170M3258	40	40	270	9	
170M3009	170M3059	170M3109	170M3159	170M3209	170M3259	50	77	515	11	
170M3010	170M3060	170M3110	170M3160	170M3210	170M3260	63	115	770	14	
170M3011	170M3061	170M3111	170M3161	170M3211	170M3261	80	185	1250	18	
170M3012	170M3062	170M3112	170M3162	170M3212	170M3262	100	360	2450	21	
170M3013	170M3063	170M3113	170M3163	170M3213	170M3263	125	550	3700	26	
170M3014	170M3064	170M3114	170M3164	170M3214	170M3264	160	1100	7500	30	
170M3015	170M3065	170M3115	170M3165	170M3215	170M3265	200	2200	15000	35	
170M3016	170M3066	170M3116	170M3166	170M3216	170M3266	250	4200	28500	40	
170M3017	170M3067	170M3117	170M3167	170M3217	170M3267	315	7000	46500	50	
170M3018	170M3068	170M3118	170M3168	170M3218	170M3268	350	10000	68500	55	
170M3019	170M3069	170M3119	170M3169	170M3219	170M3269	400	15000	105000	60	
170M3020	170M3070	170M3120	170M3170	170M3220	170M3270	450	21000	140000	65	
170M3021	170M3071	170M3121	170M3171	170M3221	170M3271	500	27000	180000	70	
170M3022	170M3072	170M3122	170M3172	170M3222	170M3272	550	34000	230000	75	
170M3023	170M3073	170M3123	170M3173	170M3223	170M3273	630	48500	325000	80	
170M4008	170M4058	170M4108	170M4158	170M4208	170M4258	200	1650	11500	45	
170M4009	170M4059	170M4109	170M4159	170M4209	170M4259	250	3100	21000	55	
170M4010	170M4060	170M4110	170M4160	170M4210	170M4260	315	6200	42000	58	
170M4011	170M4061	170M4111	170M4161	170M4211	170M4261	350	8500	59000	60	
170M4012	170M4062	170M4112	170M4162	170M4212	170M4262	400	13500	91500	65	
170M4013	170M4063	170M4113	170M4163	170M4213	170M4263	450	17000	120000	70	
170M4014	170M4064	170M4114	170M4164	170M4214	170M4264	500	25000	170000	72	
170M4015	170M4065	170M4115	170M4165	170M4215	170M4265	550	34000	230000	75	
170M4016	170M4066	170M4116	170M4166	170M4216	170M4266	630	52000	350000	80	
170M4017	170M4067	170M4117	170M4167	170M4217	170M4267	700	69500	465000	85	
170M4018	170M4068	170M4118	170M4168	170M4218	170M4268	800	105000	725000	95	
170M4019	170M4069	170M4119	170M4169	170M4219	170M4269	±900	155000	±850000	100	
170M5008	170M5058	170M5108	170M5158	170M5208	170M5258	400	11000	74000	65	
170M5009	170M5059	170M5109	170M5159	170M5209	170M5259	450	15500	105000	70	
170M5010	170M5060	170M5110	170M5160	170M5210	170M5260	500	21500	145000	75	
170M5011	170M5061	170M5111	170M5161	170M5211	170M5261	550	28000	190000	80	
170M5012	170M5062	170M5112	170M5162	170M5212	170M5262	630	41000	275000	90	
170M5013	170M5063	170M5113	170M5163	170M5213	170M5263	700	60500	405000	95	
170M5014	170M5064	170M5114	170M5164	170M5214	170M5264	800	86000	575000	105	
170M5015	170M5065	170M5115	170M5165	170M5215	170M5265	900	125000	840000	110	
170M5016	170M5066	170M5116	170M5166	170M5216	170M5266	1000	180000	1250000	115	
170M5017	170M5067	170M5117	170M5167	170M5217	170M5267	1100	245000	1600000	120	
170M5018	170M5068	170M5118	170M5168	170M5218	170M5268	1250	365000	2400000	130	
170M6008	170M6058	170M6108	170M6158	170M6208	170M6258	500	14000	95000	95	
170M6009	170M6059	170M6109	170M6159	170M6209	170M6259	550	19500	135000	100	
170M6010	170M6060	170M6110	170M6160	170M6210	170M6260	630	31000	210000	105	
170M6011	170M6061	170M6111	170M6161	170M6211	170M6261	700	44500	300000	110	
170M6012	170M6062	170M6112	170M6162	170M6212	170M6262	800	69500	465000	115	
170M6013	170M6063	170M6113	170M6163	170M6213	170M6263	900	100000	670000	120	
170M6014	170M6064	170M6114	170M6164	170M6214	170M6264	1000	140000	945000	125	
170M6015	170M6065	170M6115	170M6165	170M6215	170M6265	1100	190000	1300000	130	
170M6016	170M6066	170M6116	170M6166	170M6216	170M6266	1250	290000	1950000	140	
170M6017	170M6067	170M6117	170M6167	170M6217	170M6267	1400	370000	2450000	155	
170M6018	170M6068	170M6118	170M6168	170M6218	170M6268	1500	460000	3100000	160	
170M6019	170M6069	170M6119	170M6169	170M6219	170M6269	1600	580000	3900000	160	
170M6020	170M6070	170M6120	170M6170	170M6220	170M6270	±1800	880000	±5250000	165	
170M6021	170M6071	170M6121	170M6171	170M6221	170M6271	±2000	1150000	±6350000	175	

High Speed Fuses

†Rated voltage (IEC) 600V.
‡Rated voltage (IEC) 550V.
• Watts loss provided at rated current.
• Microswitch indicator ordered separately. See accessories on pages 185-186.
• For fuse curves see pages 130 and 131.

Square Body Flush End Contact — 690V/700V (IEC/UL): 40-2000A

690V/700V (IEC/UL) 40-2000A

Specifications

Description: Square body flush end contact high speed fuses.

Dimensions: See dimensions illustrations.

Ratings:

- Volts: — 690Vac (IEC)
— 700Vac (UL)
- Amps: — 40-2000A
- IR: — 200kA RMS Sym.



Agency Information: CE, Designed and tested to IEC 60269: Part 4, UL Recognized. Consult Cooper Bussmann for UL Recognition / CSA Component Acceptance Status.

Electrical Characteristics

Total Clearing I²t

The total clearing I²t at rated voltage and at power factor of 15% are given in the electrical characteristics. For other voltages, the clearing I²t is found by multiplying by correction factor, K, given as a function of applied working voltage, E_g, (rms).

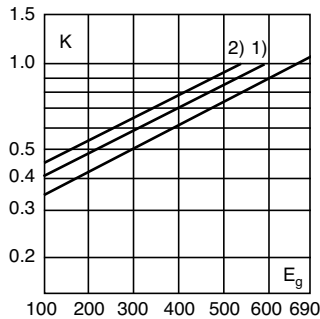

1) Rated voltage 600V.
2) Rated voltage 550V

Arc Voltage

This curve gives the peak arc voltage, U_L, which may appear across the fuse during its operation as a function of the applied working voltage, E_g, (rms) at a power factor of 15%.

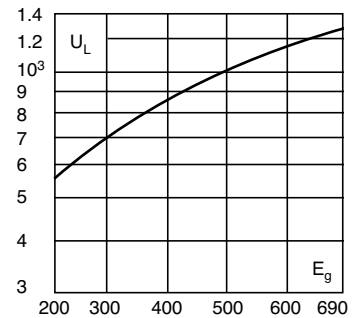

Power Losses

Watts loss at rated current is given in the electrical characteristics. The curve allows the calculation of the power losses at load currents lower than the rated current. The correction factor, K_p, is given as a function of the RMS load current, I_b, in % of the rated current.

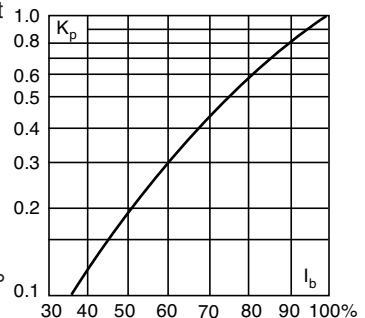

Features and Benefits

- Excellent DC performance
- Low arc voltage and low energy let-through (I²t)
- Low watts loss
- Superior cycling capability

Typical Applications

- DC common bus
- DC drives
- Power converters/rectifiers
- Reduced voltage starters

For Other Voltage Ratings in This Body Style

- See pages 148 (1000V) and 162 (1250V/1300V)

Dimensions (mm)

Type -B/-, -BKN/-, -G/-, -GKN/-

Size	A	B	D	E	F	F** (In)	G	H
1*	50	51	59	45	M8	5/16" - 18 UNC-2B	5	ø17
1	50	51	69	53	M8	5/16" - 18 UNC-2B	8	ø20
2	50	51	77	61	M10	3/8" - 16 UNC-2B	10	ø24
3	51	53	92	76	M12	1/2" - 13 UNC-2B	10	ø30

**Valid for fuses type -G/- & -GKN/-

NB: B = 65 for: Size 2, 1100-1250A
Size 3, 1600-2000A

1mm = 0.0394" / 1" = 25.4mm

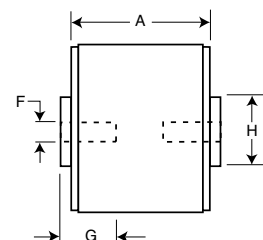
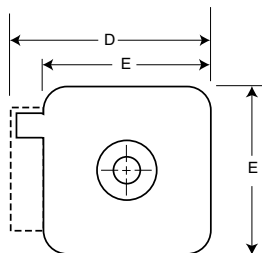
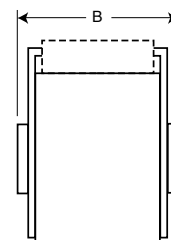

Square Body Flush End Contact — 690V/700V (IEC/UL): 40-2000A

Catalog Numbers

Catalog Numbers				Size	Electrical Characteristics				
-B/ Visual Indicator	-BKN/ Type K Indicator for Micro	-G/ Visual Indicator	-GKN/ Type K Indicator for Micro		Rated Current RMS-Amps	Pt (A ² Sec)		Watts Loss	
						Pre-arc	Clearing at 660V		
170M3408	170M3458	170M3508	170M3558	1*	40	40	270	9	
170M3409	170M3459	170M3509	170M3559		50	77	515	11	
170M3410	170M3460	170M3510	170M3560		63	115	770	14	
170M3411	170M3461	170M3511	170M3561		80	185	1250	18	
170M3412	170M3462	170M3512	170M3562		100	360	2450	21	
170M3413	170M3463	170M3513	170M3563		125	550	3700	26	
170M3414	170M3464	170M3514	170M3564		160	1100	7500	30	
170M3415	170M3465	170M3515	170M3565		200	2200	15000	35	
170M3416	170M3466	170M3516	170M3566		250	4200	28500	40	
170M3417	170M3467	170M3517	170M3567		315	7000	46500	50	
170M3418	170M3468	170M3518	170M3568		350	10000	68500	55	
170M3419	170M3469	170M3519	170M3569		400	15000	105000	60	
170M3420	170M3470	170M3520	170M3570		450	21000	140000	65	
170M3421	170M3471	170M3521	170M3571		500	27000	180000	70	
170M3422	170M3472	170M3522	170M3572		550	34000	230000	75	
170M3423	170M3473	170M3523	170M3573		630	48500	325000	80	
170M4408	170M4458	170M4508	170M4558		1	200	1650	11500	45
170M4409	170M4459	170M4509	170M4559			250	3100	21000	55
170M4410	170M4460	170M4510	170M4560			315	6200	42000	58
170M4411	170M4461	170M4511	170M4561	350		8500	59000	60	
170M4412	170M4462	170M4512	170M4562	400		13500	91500	65	
170M4413	170M4463	170M4513	170M4563	450		17000	120000	70	
170M4414	170M4464	170M4514	170M4564	500		25000	170000	72	
170M4415	170M4465	170M4515	170M4565	550		34000	230000	75	
170M4416	170M4466	170M4516	170M4566	630		52000	350000	80	
170M4417	170M4467	170M4517	170M4567	700		69500	465000	85	
170M4418	170M4468	170M4518	170M4568	800		105000	725000	95	
170M4419	170M4469	170M4519	170M4569	±900	155000	±850000	100		
170M5408	170M5458	170M5508	170M5558	2	400	11000	74000	65	
170M5409	170M5459	170M5509	170M5559		450	15500	105000	70	
170M5410	170M5460	170M5510	170M5560		500	21500	145000	75	
170M5411	170M5461	170M5511	170M5561		550	28000	190000	80	
170M5412	170M5462	170M5512	170M5562		630	41000	275000	90	
170M5413	170M5463	170M5513	170M5563		700	60500	405000	95	
170M5414	170M5464	170M5514	170M5564		800	86000	575000	105	
170M5415	170M5465	170M5515	170M5565		900	125000	840000	110	
170M5416	170M5466	170M5516	170M5566		1000	180000	1250000	115	
170M5417	170M5467	170M5517	170M5567		1100	245000	1600000	120	
170M5418	170M5468	170M5518	170M5568		1250	365000	2400000	130	
170M6408	170M6458	170M6508	170M6558	3	500	14000	95000	95	
170M6409	170M6459	170M6509	170M6559		550	19500	135000	100	
170M6410	170M6460	170M6510	170M6560		630	31000	210000	105	
170M6411	170M6461	170M6511	170M6561		700	44500	300000	110	
170M6412	170M6462	170M6512	170M6562		800	69500	465000	115	
170M6413	170M6463	170M6513	170M6563		900	100000	670000	120	
170M6414	170M6464	170M6514	170M6564		1000	140000	945000	125	
170M6415	170M6465	170M6515	170M6565		1100	190000	1300000	130	
170M6416	170M6466	170M6516	170M6566		1250	290000	1950000	140	
170M6417	170M6467	170M6517	170M6567		1400	370000	2450000	155	
170M6418	170M6468	170M6518	170M6568		1500	460000	3100000	160	
170M6419	170M6469	170M6519	170M6569		1600	580000	3900000	160	
170M6420	170M6470	170M6520	170M6570		†1800	880000	†5250000	165	
170M6421	170M6471	170M6521	170M6571		‡2000	1150000	‡6350000	175	

†Rated voltage (IEC) 600V.

‡Rated voltage (IEC) 550V.

* Watts loss provided at rated current.

• Microswitch indicator ordered separately. See accessories on pages 185-186.

• For fuse curves see pages 130 and 131.

High Speed Fuses

Square Body US Style — 690V/700V (IEC): 40-2000A

690V/700V (IEC) 40-2000A

Specifications

Description: Square body US style high speed fuses.

Dimensions: See dimensions illustration.

Ratings:

Volts: — 690Vac (IEC)

— 700Vac (UL)

Amps: — 40-200A

IR: — 200kA RMS Sym.

Agency Information: CE, Designed and tested to IEC 60269: Part 4, UL Recognized. Consult Cooper Bussmann for UL Recognition/ CSA Component Acceptance status.



Electrical Characteristics

Total Clearing I²t

The total clearing I²t at rated voltage and at power factor of 15% are given in the electrical characteristics. For other voltages, the clearing I²t is found by multiplying by correction factor, K, given as a function of applied working voltage, E_g, (rms).

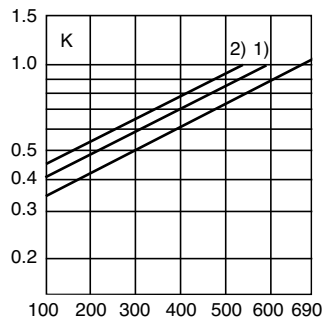

1) Rated voltage 600V.
2) Rated voltage 550V

Dimensions (mm)

Type -FU/-, -FKE/-, FU/115-, -FKE/115

Size	A	B	B**	C1	C1**	C2	C2**	D	E	H	I
1*	50	110	148	85	123	72	110	59	45	20	10
1	50	136	157	104	126	78	100	69	53	25	14
2	50	135	159	105	125	78	99	77	61	25	14
3	51	135	155	106	125	77	97	92	76	36	16

**Valid for fuses type -FU/115 & -FKE/115.

1mm = 0.0394" / 1" = 25.4mm

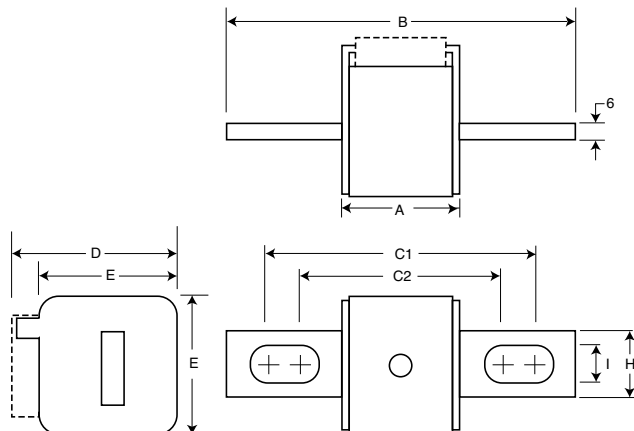

Arc Voltage

This curve gives the peak arc voltage, U_L, which may appear across the fuse during its operation as a function of the applied working voltage, E_g, (rms) at a power factor of 15%.

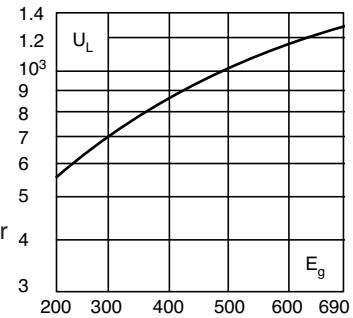

Power Losses

Watts loss at rated current is given in the electrical characteristics. The curve allows the calculation of the power losses at load currents lower than the rated current. The correction factor, K_p, is given as a function of the RMS load current, I_b, in % of the rated current.

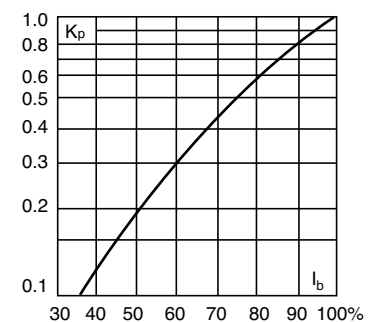

Features and Benefits

- Excellent DC performance
- Low arc voltage and low energy let-through (I²t)
- Low watts loss
- Superior cycling capability

Typical Applications

- DC common bus
- DC drives
- Power converters/rectifiers
- Reduced voltage starters

For Other Voltage Ratings in This Body Style

- See pages 150 (1000V) and 164 (1250V/1300V)

Square Body US style — 690V/700V (IEC): 40-2000A

Catalog Numbers

Catalog Numbers				Size	Electrical Characteristics				
-FU/ Without Indicator	-FKE/ Type K Indicator for Micro	-FU/115 Without Indicator	-FKE/115 Type K Indicator for Micro		Rated Current RMS-Amps	Pt (A ² Sec)		Watts Loss	
						Pre-arc	Clearing at 660V		
170M3608	170M3658	170M3708	170M3758	1*	40	40	270	9	
170M3609	170M3659	170M3709	170M3759		50	77	515	11	
170M3610	170M3660	170M3710	170M3760		63	115	770	14	
170M3611	170M3661	170M3711	170M3761		80	185	1250	18	
170M3612	170M3662	170M3712	170M3762		100	360	2450	21	
170M3613	170M3663	170M3713	170M3763		125	550	3700	26	
170M3614	170M3664	170M3714	170M3764		160	1100	7500	30	
170M3615	170M3665	170M3715	170M3765		200	2200	15000	35	
170M3616	170M3666	170M3716	170M3766		250	4200	28500	40	
170M3617	170M3667	170M3717	170M3767		315	7000	46500	50	
170M3618	170M3668	170M3718	170M3768		350	10000	68500	55	
170M3619	170M3669	170M3719	170M3769		400	15000	105000	60	
170M3620	170M3670	170M3720	170M3770		450	21000	140000	65	
170M3621	170M3671	170M3721	170M3771		500	27000	180000	70	
170M3622	170M3672	170M3722	170M3772		550	34000	230000	75	
170M3623	170M3673	170M3723	170M3773		630	48500	325000	80	
170M4608	170M4658	170M4708	170M4758		1	200	1650	11500	45
170M4609	170M4659	170M4709	170M4759			250	3100	21000	55
170M4610	170M4660	170M4710	170M4760			315	6200	42000	58
170M4611	170M4661	170M4711	170M4761	350		8500	59000	60	
170M4612	170M4662	170M4712	170M4762	400		13500	91500	65	
170M4613	170M4663	170M4713	170M4763	450		17000	120000	70	
170M4614	170M4664	170M4714	170M4764	500		25000	170000	72	
170M4615	170M4665	170M4715	170M4765	550		34000	230000	75	
170M4616	170M4666	170M4716	170M4766	630		52000	350000	80	
170M4617	170M4667	170M4717	170M4767	700		69500	465000	85	
170M4618	170M4668	170M4718	170M4768	800		105000	725000	95	
170M4619	170M4669	170M4719	170M4769	±900	155000	±850000	100		
170M5608	170M5658	170M5708	170M5758	2	400	11000	74000	65	
170M5609	170M5659	170M5709	170M5759		450	15500	105000	70	
170M5610	170M5660	170M5710	170M5760		500	21500	145000	75	
170M5611	170M5661	170M5711	170M5761		550	28000	190000	80	
170M5612	170M5662	170M5712	170M5762		630	41000	275000	90	
170M5613	170M5663	170M5713	170M5763		700	60500	405000	95	
170M5614	170M5664	170M5714	170M5764		800	86000	575000	105	
170M5615	170M5665	170M5715	170M5765		900	125000	840000	110	
170M5616	170M5666	170M5716	170M5766		1000	180000	1250000	115	
170M5617	170M5667	170M5717	170M5767		1100	245000	1600000	120	
170M5618	170M5668	170M5718	170M5768		1250	365000	2400000	130	
170M6608	170M6658	170M6708	170M6758	3	500	14000	95000	95	
170M6609	170M6659	170M6709	170M6759		550	19500	135000	100	
170M6610	170M6660	170M6710	170M6760		630	31000	210000	105	
170M6611	170M6661	170M6711	170M6761		700	44500	300000	110	
170M6612	170M6662	170M6712	170M6762		800	69500	465000	115	
170M6613	170M6663	170M6713	170M6763		900	100000	670000	120	
170M6614	170M6664	170M6714	170M6764		1000	140000	945000	125	
170M6615	170M6665	170M6715	170M6765		1100	190000	1300000	130	
170M6616	170M6666	170M6716	170M6766		1250	290000	1950000	140	
170M6617	170M6667	170M6717	170M6767		1400	370000	2450000	155	
170M6618	170M6668	170M6718	170M6768		1500	460000	3100000	160	
170M6619	170M6669	170M6719	170M6769		1600	580000	3900000	160	
170M6620	170M6670	170M6720	170M6770		†1800	880000	†5250000	165	
170M6621	170M6671	170M6721	170M6771		±2000	1150000	±6350000	175	

†Rated voltage (IEC) 600V.

‡Rated voltage (IEC) 550V.

• Watts loss provided at rated current.

• Microswitch indicator ordered separately. See accessories on pages 185-186.

• For fuse curves see pages 130 and 131.

High Speed Fuses

Square Body French Style — 690V/700V (IEC/UL): 40-1500A

690V/700V (IEC/UL) 40-1500A

Specifications

Description: Square body French style high speed fuses.

Dimensions: See dimensions illustration.

Ratings:

Volts: — 690Vac (IEC)

— 700Vac (UL)

Amps: — 40-1500A

IR: — 200kA RMS Sym.

Agency Information: CE, Designed and tested to IEC 60269: Part 4, UL Recognized.

Electrical Characteristics

Total Clearing I^2t

The total clearing I^2t at rated voltage and at power factor of 15% are given in the electrical characteristics. For other voltages, the clearing I^2t is found by multiplying by correction factor, K, given as a function of applied working voltage, E_g , (rms).

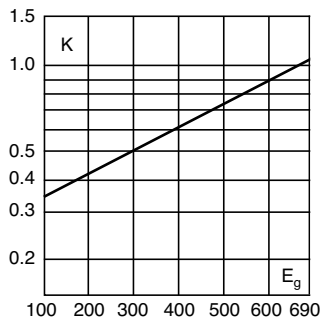

Arc Voltage

This curve gives the peak arc voltage, U_L , which may appear across the fuse during its operation as a function of the applied working voltage, E_g , (rms) at a power factor of 15%.

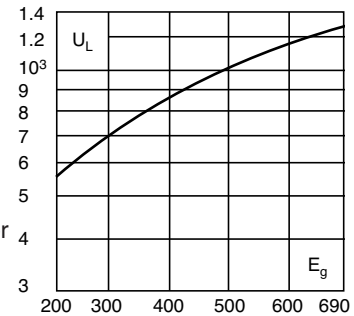

Power Losses

Watts loss at rated current is given in the electrical characteristics. The curve allows the calculation of the power losses at load currents lower than the rated current. The correction factor, K_p , is given as a function of the RMS load current, I_b , in % of the rated current.

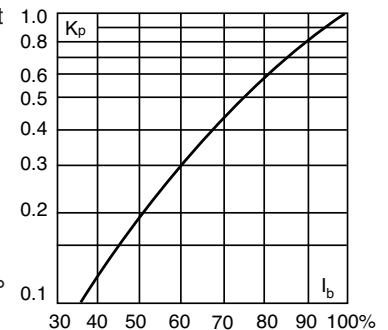

Features and Benefits

- Excellent DC performance
- Low arc voltage and low energy let-through (I^2t)
- Low watts loss
- Superior cycling capability

Typical Applications

- DC common bus
- DC drives
- Power converters/rectifiers
- Reduced voltage starters

Dimensions (mm)

Type -E/-, -EKN/-

Size	A	B	C	D	E	H	I	J
1*	50	102	76	59	45	18	9	13
1	50	111	86	69	53	25	11	11
2	50	126	91	77	61	30	13	12
3	51	126	91	92	76	36	13	13

1mm = 0.0394" / 1" = 25.4mm

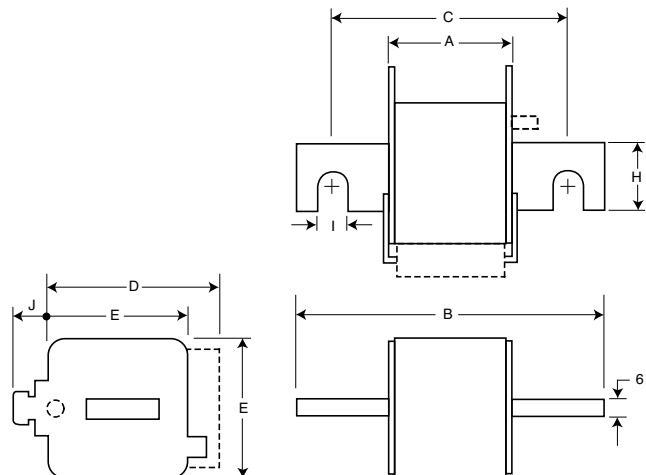

Square Body French Style — 690V/700V (IEC/UL): 40-1500A

Catalog Numbers

Catalog Numbers		Size	Electrical Characteristics			
-E/ Type T Indicator For Micro	-EKN/ Type K Indicator for Micro		Rated Current RMS-Amps	I ₂ t (A ² Sec)		Watts Loss
				Pre-arc	Clearing at 660V	
170M3308	170M3358	1*	40	40	270	9
170M3309	170M3359		50	77	515	11
170M3310	170M3360		63	115	770	14
170M3311	170M3361		80	185	1250	18
170M3312	170M3362		100	360	2450	21
170M3313	170M3363		125	550	3700	26
170M3314	170M3364		160	1100	7500	30
170M3315	170M3365		200	2200	15000	35
170M3316	170M3366		250	4200	28500	40
170M3317	170M3367		315	7000	46500	50
170M3318	170M3368		350	10000	68500	55
170M3319	170M3369		400	15000	105000	60
170M3320	170M3370		450	21000	140000	65
170M3321	170M3371		500	27000	180000	70
170M4308	170M4358		1	200	1650	11500
170M4309	170M4359	250		3100	21000	55
170M4310	170M4360	315		6200	42000	58
170M4311	170M4361	350		8500	59000	60
170M4312	170M4362	400		13500	91500	65
170M4313	170M4363	450		17000	120000	70
170M4314	170M4364	500		25000	170000	72
170M4315	170M4365	550		34000	230000	75
170M4316	170M4366	630		52000	350000	80
170M4317	170M4367	700		69500	465000	85
170M4318	170M4368	800		105000	725000	95
170M5308	170M5358	2	400	11000	74000	65
170M5309	170M5359		450	15500	105000	70
170M5310	170M5360		500	21500	145000	75
170M5311	170M5361		550	28000	190000	80
170M5312	170M5362		630	41000	275000	90
170M5313	170M5363		700	60500	405000	95
170M5314	170M5364		800	86000	575000	105
170M5315	170M5365		900	125000	840000	110
170M5316	170M5366		1000	180000	1250000	115
170M6308	170M6358	3	500	14000	95000	95
170M6309	170M6359		550	19500	135000	100
170M6310	170M6360		630	31000	210000	105
170M6311	170M6361		700	44500	300000	110
170M6312	170M6362		800	69500	465000	115
170M6313	170M6363		900	100000	670000	120
170M6314	170M6364		1000	140000	945000	125
170M6315	170M6365		1100	190000	1300000	130
170M6316	170M6366		1250	290000	1950000	140
170M6317	170M6367		1400	370000	2450000	155
170M6318	170M6368		1500	460000	3100000	160

- Watts loss provided at rated current.
- Microswitch indicator ordered separately. See accessories on pages 185-186.
- For fuse curves see pages 130 and 131.

High Speed Fuses

Square Body Size 1*, 1 — 690V/700V (IEC/UL): 40-2000A

Size 1* — 40-630A: 690V

Time-Current Curve

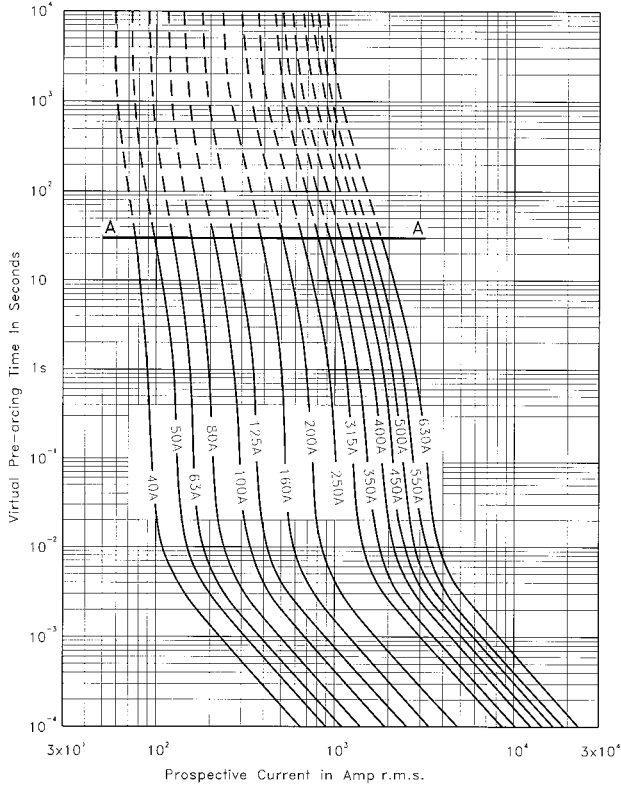

Size 1 — 200-900A: 690V

Time-Current Curve

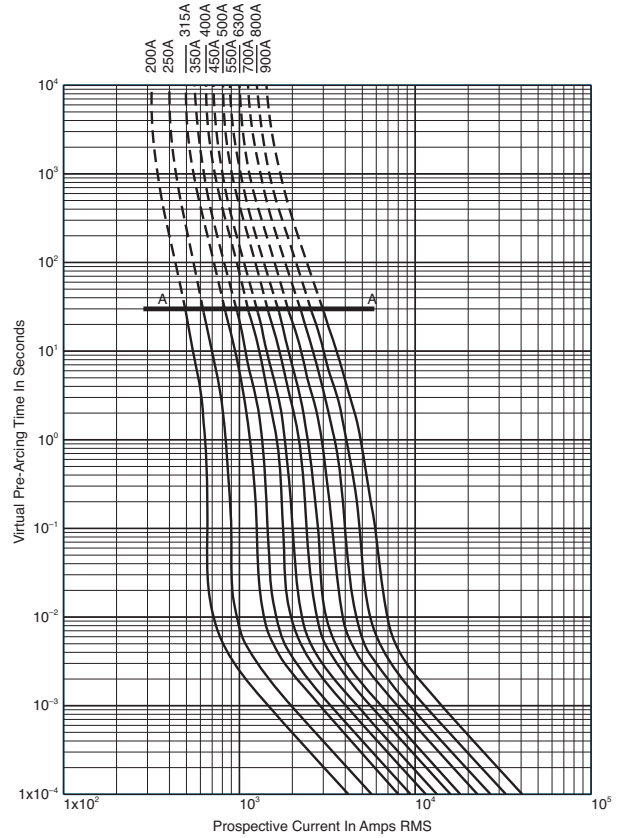

Peak Let-Through Curve

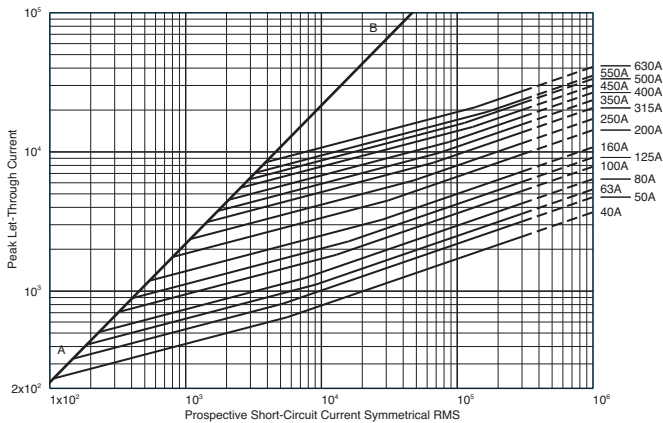

Peak Let-Through Curve

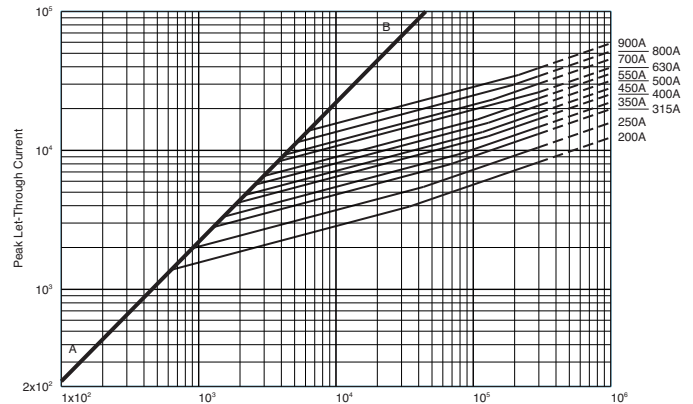

900 amp fuse is derated to 550V (IEC).

Square Body Size 2, 3 — 690V/700V (IEC/UL): 40-2000A

Size 2 — 400-1250A: 690V
Time-Current Curve

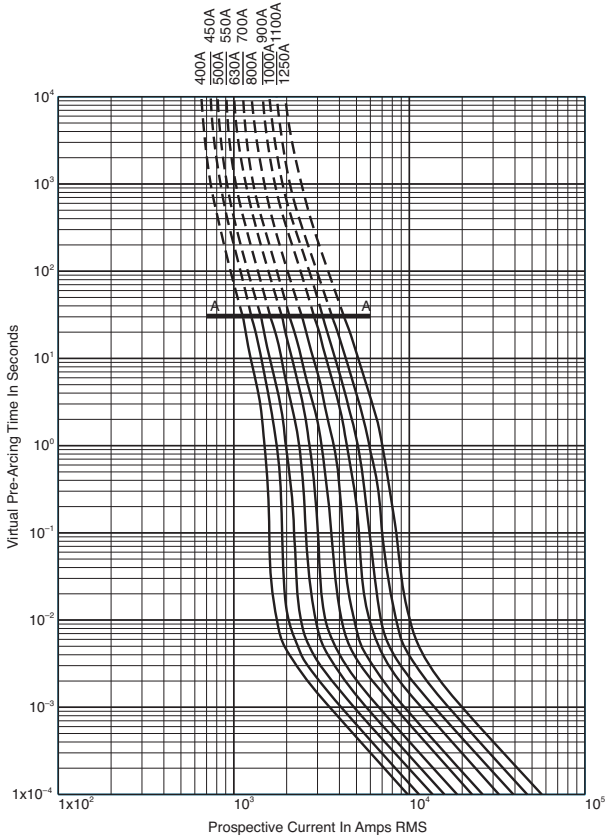

Size 3 — 500-2000A: 690V
Time-Current Curve

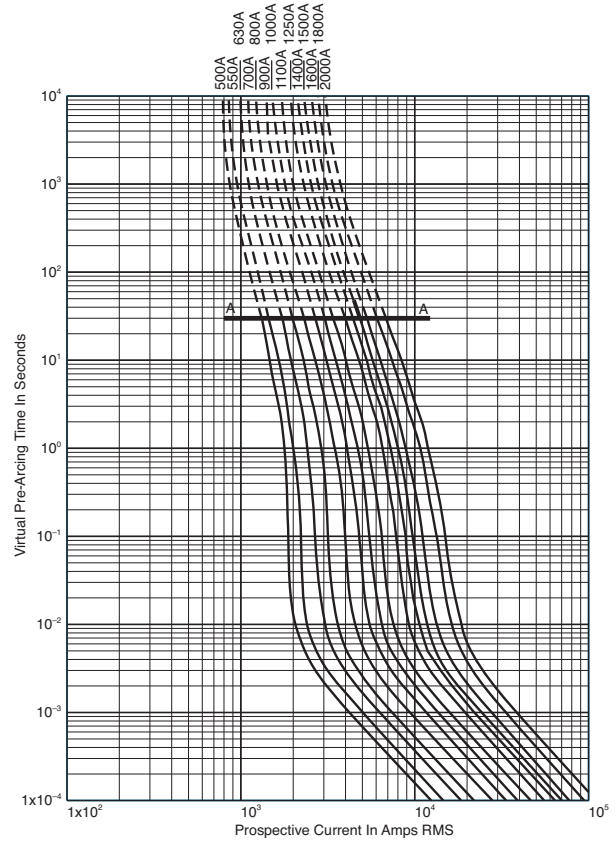

High Speed
Fuses

Peak Let-Through Curve

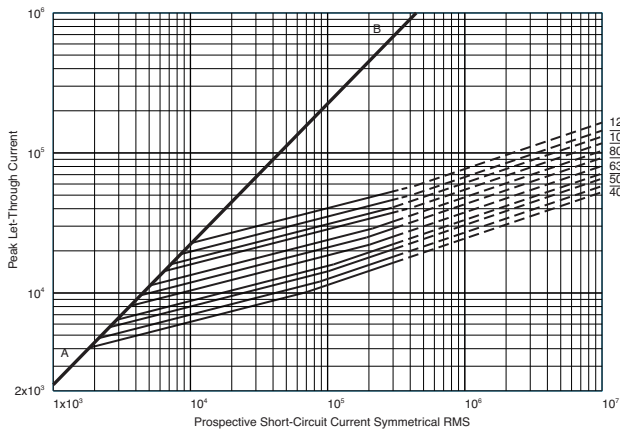

Peak Let-Through Curve

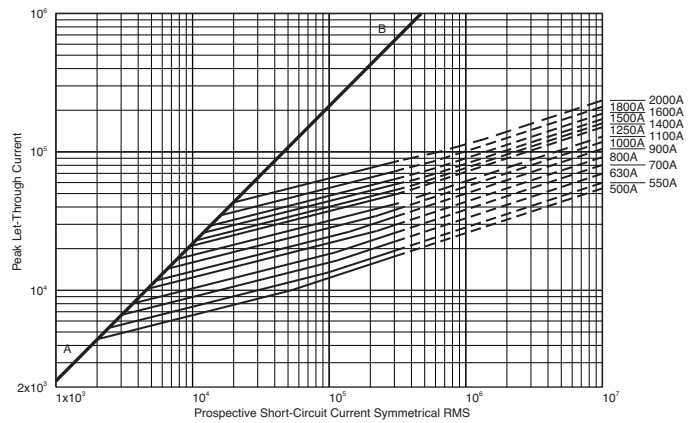

1800A fuse is derated to 600V (IEC).
2000A fuse is derated to 550V (IEC).

Square Body DIN 43 620 — 690V/700V (IEC/UL): 40-1000A

690V/700V (IEC/UL) 40-1000A

Specifications

Description: Square body DIN 43 620 blade style high speed fuses.

Dimensions: See dimensions illustration.

Ratings:

Volts: — 690Vac (IEC)
— 700Vac (UL)

Amps: — 40-1000A

IR: — 200kA RMS Sym.

Agency Information: CE, Designed and tested to IEC 60269: Part 4, UL Recognized.

Electrical Characteristics

Total Clearing I^2t

The total clearing I^2t at rated voltage and at power factor of 15% are given in the electrical characteristics. For other voltages, the clearing I^2t is found by multiplying by correction factor, K , given as a function of applied working voltage, E_g , (rms).

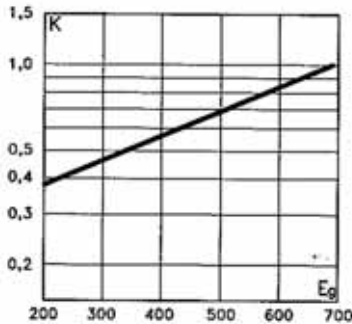

Arc Voltage

This curve gives the peak arc voltage, U_L , which may appear across the fuse during its operation as a function of the applied working voltage, E_g , (rms) at a power factor of 15%.

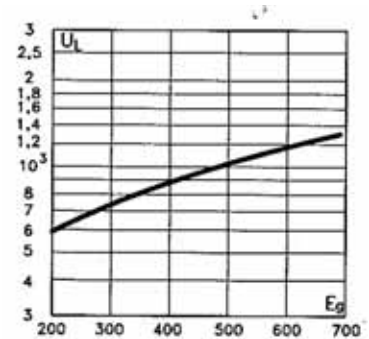

Power Losses

Watts loss at rated current is given in the electrical characteristics. The curve allows the calculation of the power losses at load currents lower than the rated current. The correction factor, K_p , is given as a function of the RMS load current, I_b , in % of the rated current.

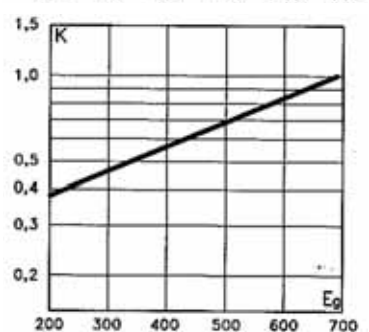

Features and Benefits

- Excellent DC performance
- Low arc voltage and low energy let-through (I^2t)
- Low watts loss
- Superior cycling capability

Typical Applications

- DC common bus
- DC drives
- Power converters/rectifiers
- Reduced voltage starters

For Full Range Fuses in This Body Style

- See page 140

Dimensions (mm)

Type DIN 1*, DIN 2, DIN 3

Size	A	B	D	E	F	H
1*	69	135	58	45	40	20
2	69	150	71	55	48	26
3	68	150	88	76	60	33

1mm = 0.0394" / 1" = 25.4mm

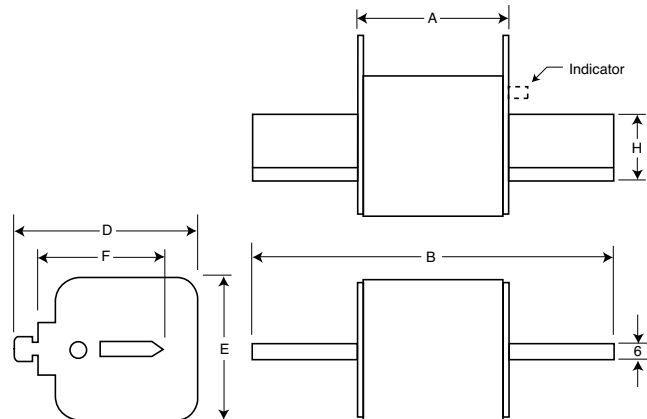

Square Body DIN 43 620 — 690V/700V (IEC/UL): 40-600A

Catalog Numbers

Catalog Numbers DIN Type T Indicator for Micro	Size	Electrical Characteristics			
		Rated Current RMS-Amps	Pt (A*Sec)		Watts Loss
			Pre-arc	Clearing at 660V	
170M3808D	1*	40	40	285	4
170M3809D		50	78	550	4.5
170M3810D		63	120	850	6.5
170M3811D		80	185	1350	8.5
170M3812D		100	360	2600	10
170M3813D		125	550	3900	11
170M3814D		160	1150	8250	12
170M3815D		200	2300	16500	12.5
170M3816D		250	4350	31000	16
170M3817D		315	7300	52000	20
170M3818D		350	10000	73000	21.5
170M3819D		400	16000	115000	60
170M4863D		450	21500	155000	26.3
170M4864D		500	27000	190000	28.5
170M4865D		550	33500	240000	33
170M4866D		630	48500	345000	37.5
170M4867D		700	69500	495000	39
170M5808D		2	400	11000	79000
170M5809D	450		16000	115000	32
170M5810D	500		21500	155000	34
170M5811D	550		29000	215000	36
170M5812D	630		41000	295000	42
170M5813D	700		60500	430000	43
170M5814D	800		86000	610000	48
170M5820D	900		125000	895000	52
170M5816D	1000		180000	1300000	53
170M5817D	1100		245000	1750000	56
170M6808D	3	500	14000	99500	43
170M6809D		550	19500	140000	44
170M6810D		630	31000	220000	45
170M6811D		700	45000	320000	46
170M6812D		800	69500	490000	48
170M6813D		900	100000	720000	50
170M6814D		1000	140000	985000	56
170M6892D		1100	190000	1400000	57
170M8554D		1250	300000	2150000	61
170M8555D		1400	380000	2700000	70
170M8556D		1500	470000	3350000	72
170M8557D		1600	585000	4150000	74

- Watts loss provided at rated current.
- Microswitch indicator ordered separately. See accessories on pages 185-186.
- For fuse curves see page 134.

Rated Current

The rated current of this fuse range has been given with copper conductors that have a current density of 1.3 A/mm² (IEC 60269-4). For conductor cross section according to IEC 60269-1, the fuses must be derated. Please contact Cooper Bussmann for application assistance.

Size 1* — 40-630A: 690V Time-Current Curve

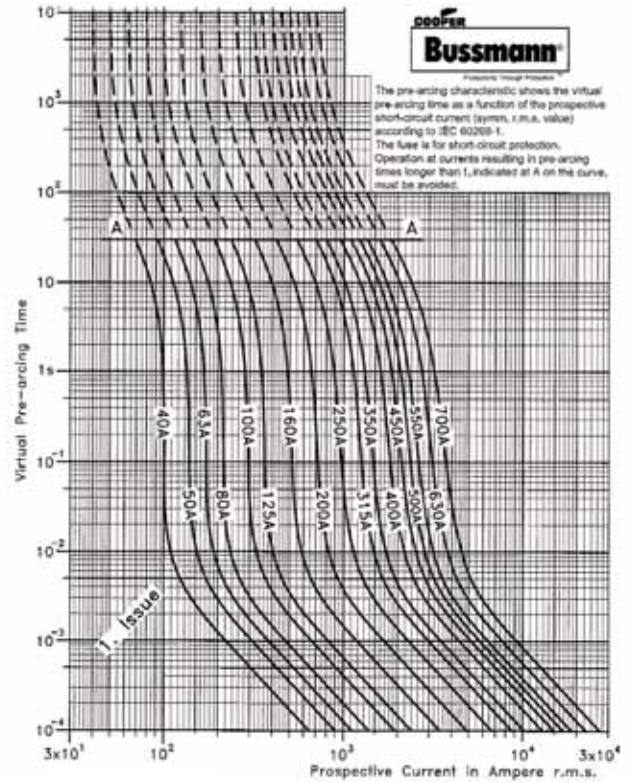

High Speed Fuses

Peak Let-Through Curve

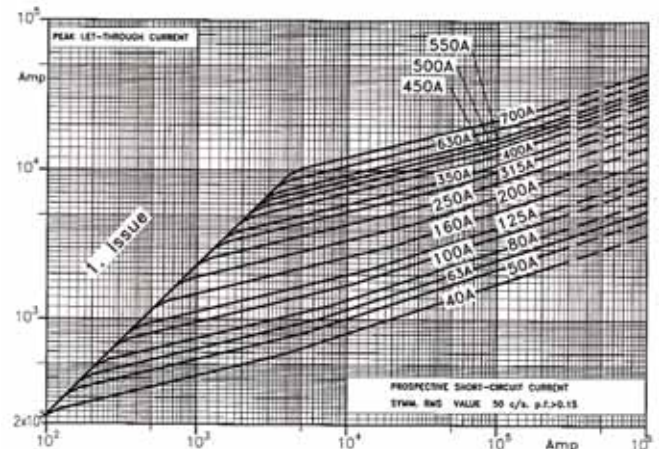

Square Body DIN 43 620 — 690V/700V (IEC/UL): 40-1000A

Size 2 — 400-1250A: 690V
Time-Current Curve

Size 3 — 500-2000A: 690V
Time-Current Curve

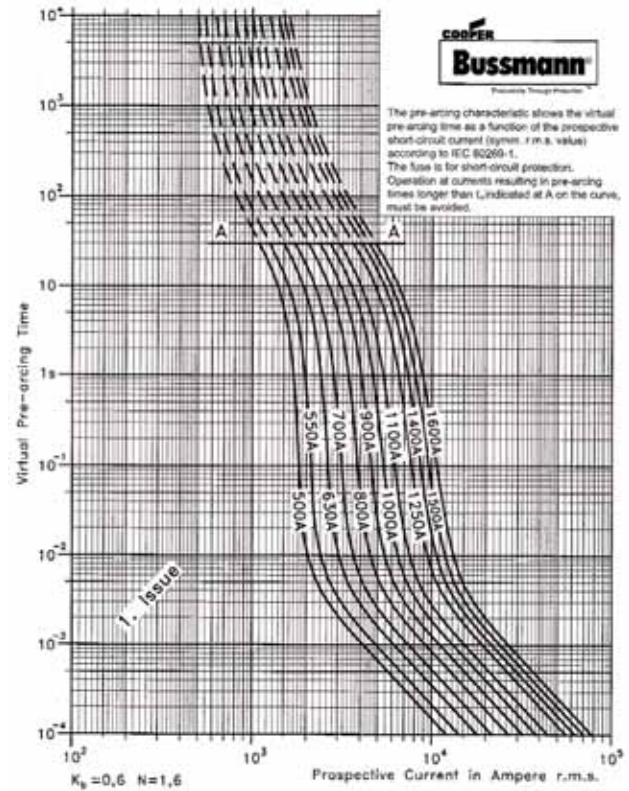
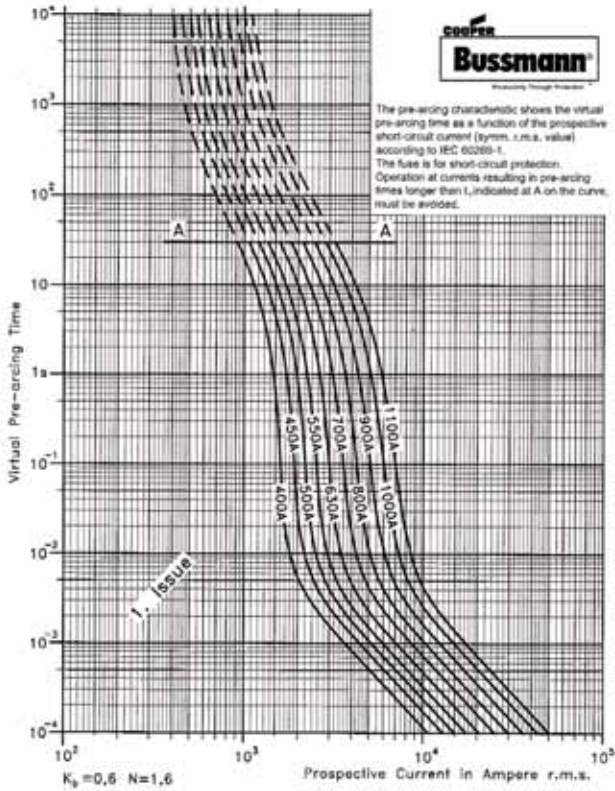

Peak Let-Through Curve

Peak Let-Through Curve

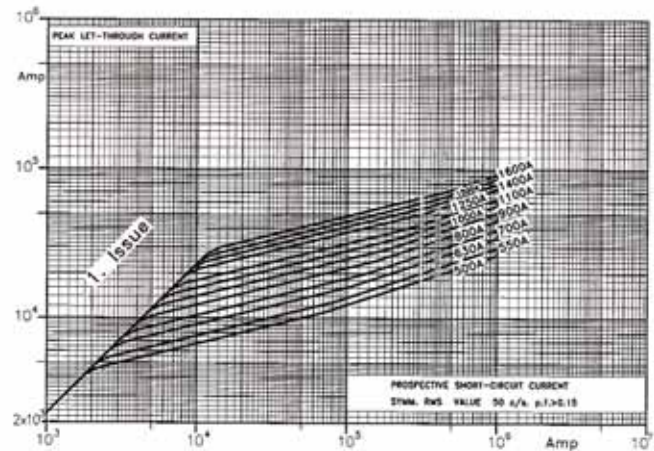
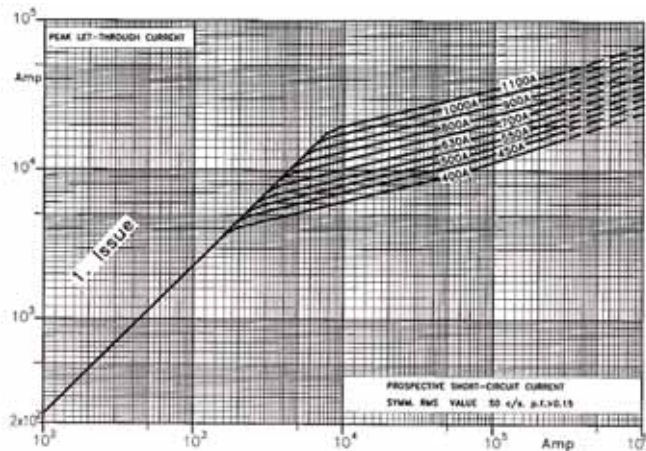

Square Body Flush End Contact — 690/700V (IEC/UL): 1000-4000A

690V (IEC) 1000-4000A

Specifications

Description: Square body flush end contact high speed fuses.

Dimensions: See dimensions illustrations.

Ratings:

- Volts: — 690Vac
- Amps: — 1000-4000A
- IR: — 200kA RMS Sym.

Agency Information: CE, Designed and tested to IEC 60269: Part 4, UL Recognized.

Electrical Characteristics

Total Clearing I^2t

The total clearing I^2t at rated voltage and at power factor of 15% are given in the electrical characteristics. For other voltages, the clearing I^2t is found by multiplying by correction factor, K, given as a function of applied working voltage, E_g , (rms).

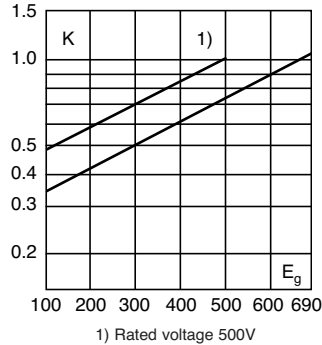

Arc Voltage

This curve gives the peak arc voltage, U_L , which may appear across the fuse during its operation as a function of the applied working voltage, E_g , (rms) at a power factor of 15%.

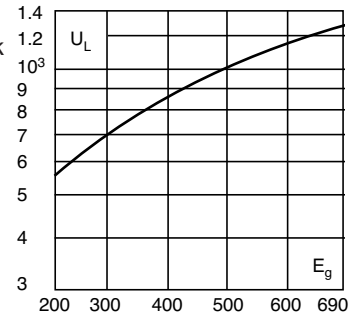

Power Losses

Watts loss at rated current is given in the electrical characteristics. The curve allows the calculation of the power losses at load currents lower than the rated current. The correction factor, K_p , is given as a function of the RMS load current, I_b , in % of the rated current.

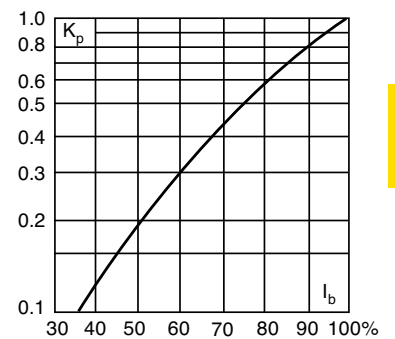

Features and Benefits

- Excellent DC performance
- Low arc voltage and low energy let-through (I^2t)
- Low watts loss
- Superior cycling capability

Typical Applications

- DC common bus
- DC drives
- Power converters/rectifiers
- Reduced voltage starters

For Other Voltage Ratings in This Body Style

- See pages 154 (1000V) and 168 (1250V)

Dimensions (mm)

Type 4B/-, 4BKN/-, 4G/-, 4GKN/-

Size	F (in)	G
4B	M10 10 deep	33
4G	½" -13 UNC-2B 10 deep	38

1mm = 0.0394" / 1" = 25.4mm

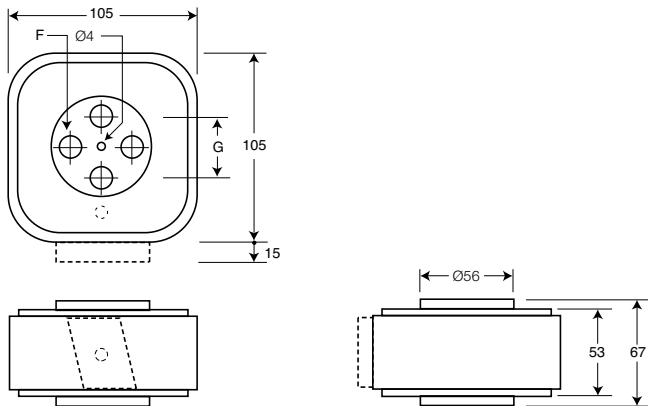

High Speed Fuses

Square Body Flush End Contact — 690V (IEC): 1000-4000A

Catalog Numbers

Catalog Numbers				Size	Electrical Characteristics					
-B/ Visual Indicator	-BKN/ Type K Indicator for Micro	-G/ Visual Indicator	-GKN/ Type K Indicator for Micro		Rated Current RMS		I ² t (A ² Sec)		Watts Loss	
					Norm. Cool.	Liquid Cool.	Pre-arc	Clearing at 660V	Norm. Cool.	Liquid Cool.
170M7058	170M7078	170M7098	170M7118	4	1000	1350	76000	505000	175	315
170M7059	170M7079	170M7099	170M7119		1250	1700	145000	965000	195	355
170M7060	170M7080	170M7100	170M7120		1400	1900	205000	1400000	205	375
170M7061	170M7081	170M7101	170M7121		1600	2200	305000	2050000	220	405
170M7062	170M7082	170M7102	170M7122		2000	2700	600000	3950000	245	445
170M7063	170M7083	170M7103	170M7123		2500	3400	1200000	7800000	275	495
170M7064	170M7084	170M7104	170M7124		3000	4100	2000000	13500000	305	555
170M7065	170M7085	170M7105	170M7125		3500	4700	3250000	22000000	325	585
170M7066	170M7086	170M7106	170M7126		†4000	†5400	4700000	†28000000	355	640

- †Rated voltage (IEC) 500V.
- Watts loss provided at rated current.
- Liquid Cool. = Liquid cooling. Temperature on the terminals not to exceed 60°C.
- Microswitch indicator ordered separately. See accessories on pages 185-186.

Size 4 — 1000-4000A: 690V Time-Current Curve

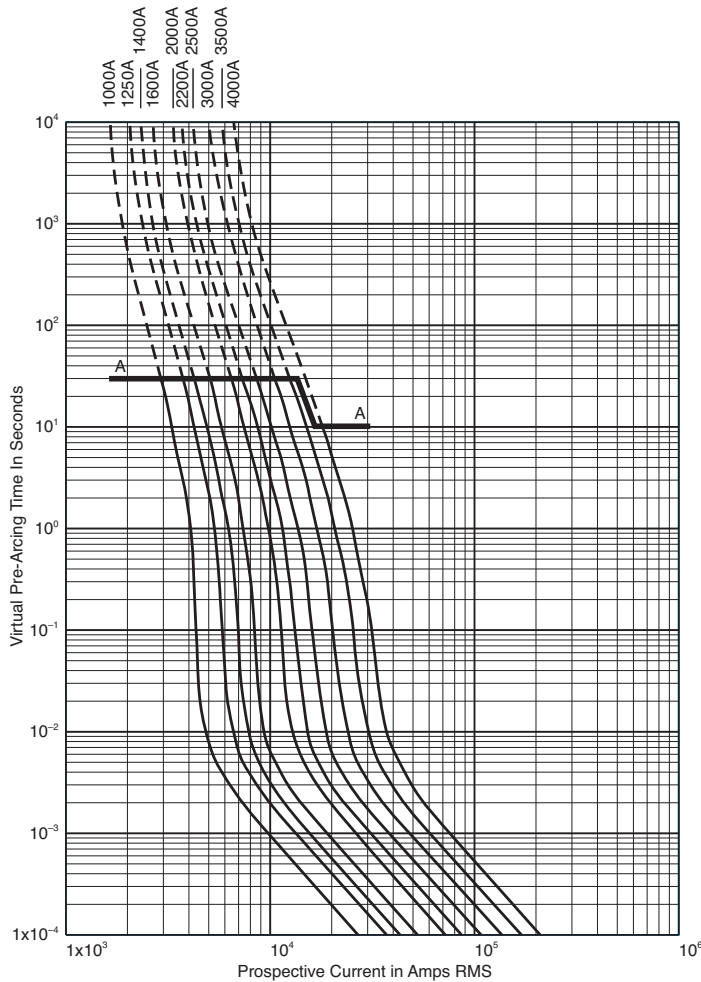

Peak Let-Through Curve

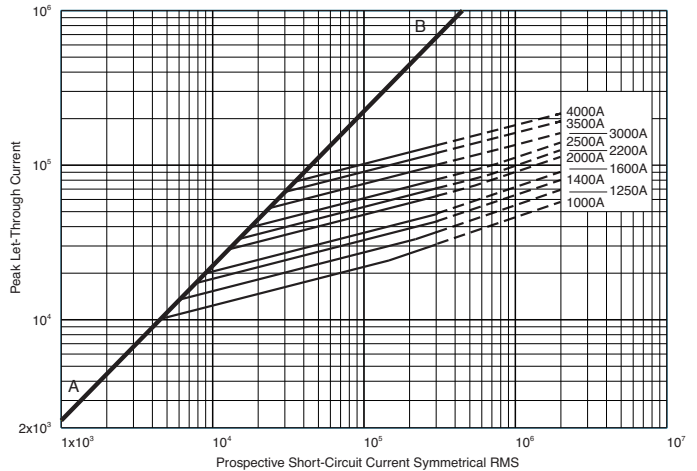

4000A fuse is derated to 500V (IEC).

Data Sheet: 17056328

Square Body Flush End Contact Size 23, 24 — 660V (IEC): 1000-7500A

660V (IEC) 1000-7500A

Specifications

Description: High speed square body fuses, for the protection of the power rectifier section of the equipment.

Dimensions: See dimensions illustration.

Ratings:

Volts: — 660Vac

Amps: — 1000-4000A

IR: — 300kA RMS Sym.

Agency Information: CE, Designed and tested to IEC 60269: Part 4, UL Recognized.



Electrical Characteristics

Total clearing I^2t

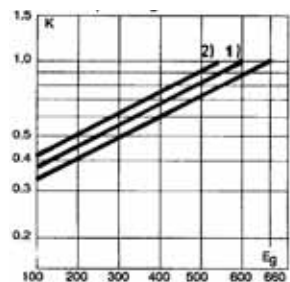

Size 23

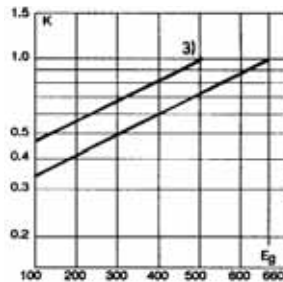

Size 24

The total clearing I^2t at rated voltage and at power factor of 15% are given in the electrical characteristics. For other voltages, the clearing I^2t is found by multiplying by correction factor, K, given as a function of applied working voltage, E_g , (rms).

Features and Benefits

- Low watts loss
- Superior cycling capability

Typical Applications

- Power converters/rectifiers
- Reduced voltage starters

Arc Voltage

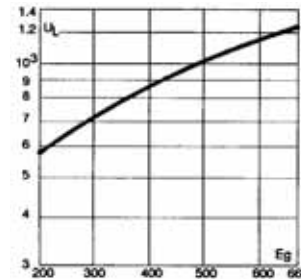

Size 23

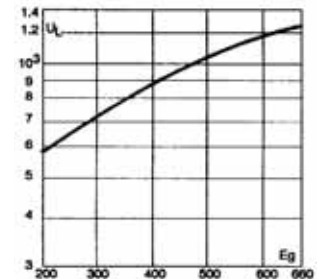

Size 24

This curve gives the peak arc voltage, U_L , which may appear across the fuse during its operation as a function of the applied working voltage E_g , (rms) at a power factor of 15%.

Power Losses

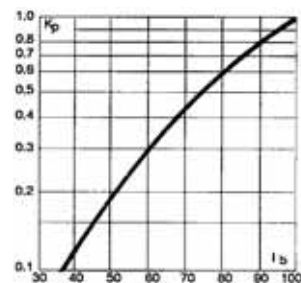

Size 23

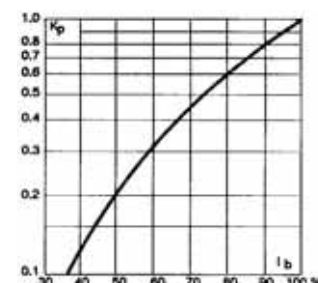

Size 24

Watts loss at rated current is given in the electrical characteristics. The curve allows the calculation of the power losses at load currents lower than the rated current. The correction factor, K_p , is given as a function of the RMS load current, I_b , in % of the rated current.

For Other Voltage Ratings in This Body Style

- See pages 157 (1000V) and 171 (1250V)

Square Body Flush End Contact Size 23, 24 — 660V (IEC): 1000-7500A

Fuse Size	Catalogue Number						Electrical Characteristics					
	-BU/55 Visual Indicator	-BKE/55 Type K Indicator	-BKN/55 Type K Indicator	-GU/55 Visual Indicator	-GKE/55 Type K Indicator	-GKN/55 Type K Indicator	Rated Voltage (V)	Rated Current RMS-Amp	I ² t (A ² Sec)		Watt Loss (W)	
	Pre-arc	Clearing at 660V										
23	170M6858	170M6898	170M6878	170M6918	170M6958	170M6938	660	1000	79,000	530,000	170.0	
	170M6859	170M6899	170M6879	170M6919	170M6959	170M6939		1100	95,000	635,000	185.0	
	170M6860	170M6900	170M6880	170M6920	170M6960	170M6940		1250	155,000	1,050,000	190.0	
	170M6861	170M6901	170M6881	170M6921	170M6961	170M6941		1400	200,000	1,350,000	210.0	
	170M6862	170M6902	170M6882	170M6922	170M6962	170M6942		1500	240,000	1,650,000	215.0	
	170M6863	170M6903	170M6883	170M6923	170M6963	170M6943		1600	315,000	2,150,000	220.0	
	170M6864	170M6904	170M6884	170M6924	170M6964	170M6944		1800	450,000	3,050,000	230.0	
	170M6865	170M6905	170M6885	170M6925	170M6965	170M6945		2000	625,000	4,200,000	240.0	
	170M6866	170M6906	170M6886	170M6926	170M6966	170M6946		2200	805,000	5,400,000	255.0	
	170M6867	170M6907	170M6887	170M6927	170M6967	170M6947		2500	1,250,000	8,350,000	265.0	
	170M6868	170M6908	170M6888	170M6928	170M6968	170M6948		3000	2,250,000	15,500,000	285.0	
	170M6869	170M6909	170M6889	170M6929	170M6969	170M6949		600	3500	3,450,000	21,000,000	315.0
	170M6870	170M6910	170M6890	170M6930	170M6970	170M6950		550	4000	5,000,000	27,500,000	340.0

Data Sheet: 170K6326

Catalog Numbers:

Fuse Size	Catalogue Number				Electrical Characteristics					
	-BU/60 without Indicator	-BKN/60 Type K Indicator	-GU/60 without Indicator	-GKN/60 Type K Indicator	Rated Voltage (V)	Rated Current RMS-Amp	I ² t (A ² Sec)		Watts Loss (W)	
	Pre-arc	Clearing at 660V								
24	170M7138	170M7158	170M7198	170M7218	690	2000	340000	2300000	340	
	170M7139	170M7159	170M7199	170M7219		2500	650000	4350000	390	
	170M7140	170M7160	170M7200	170M7220		3000	1100000	7300000	430	
	170M7141	170M7161	170M7201	170M7221		3500	1800000	12000000	460	
	170M7142	170M7162	170M7202	170M7222		4000	2700000	18000000	490	
	170M7143	170M7163	170M7203	170M7223		4500	3800000	25500000	520	
	170M7144	170M7164	170M7204	170M7224		5000	5450000	36500000	540	
	170M7145	170M7165	170M7205	170M7225		5500	7400000	49500000	560	
	170M7146	170M7166	170M7206	170M7226		6000	9600000	64000000	580	
	170M7147	170M7167	170M7207	170M7227		6500	12500000	83000000	600	
	170M7148	170M7168	170M7208	170M7228		7000	15000000	100000000	630	
	170M7149	170M7169	170M7209	170M7229		500	7500	18500000	†93000000	660

† A's @ 500V
Data Sheet: 170K6332

Size 24 Dimensions (mm):

Type – BU/55, -BKE/55, -BKN/55, -GU/55, -GKE/55, -GKN/55

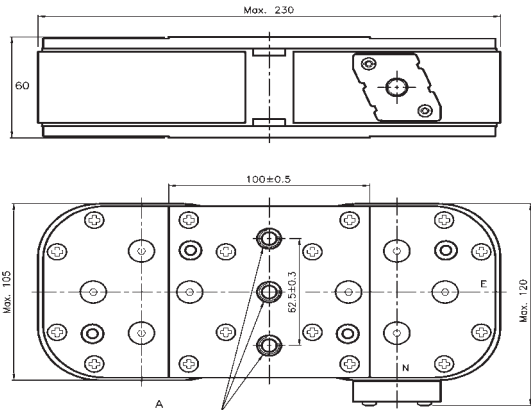

Size 23 Dimensions (mm):

Type – BU/55, -BKE/55, -BKN/55, -GU/55, -GKE/55, -GKN/55

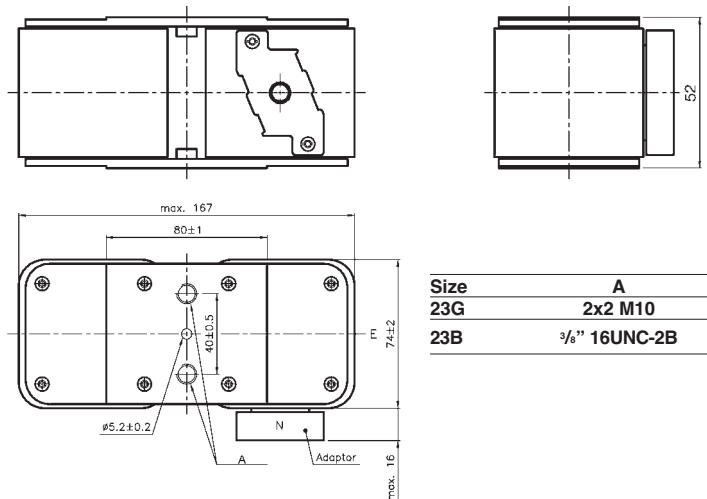

Size	A
24BKN	2x3 M12
24GKN	2x3 1/2" 16UNC-2B

Size	A
23G	2x2 M10
23B	3/8" 16UNC-2B

Square Body Flush End Contact Size 23, 24 — 660V (IEC): 1000-7500A

Size 23 — 10000-4000A: 660V
Time-Current Curve

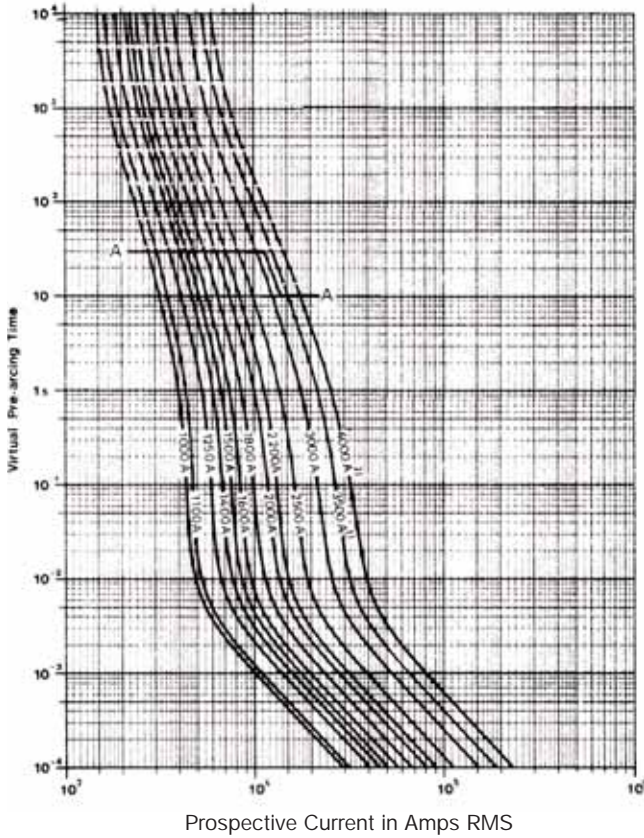

Size 24 — 2000-7500A: 660V
Time-Current Curve

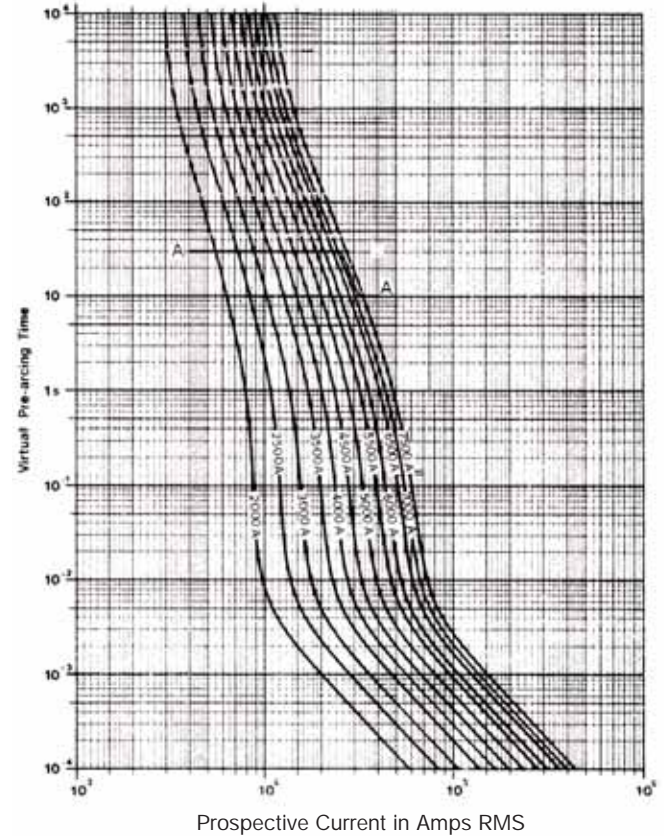

High Speed Fuses

Peak Let-Through Curve

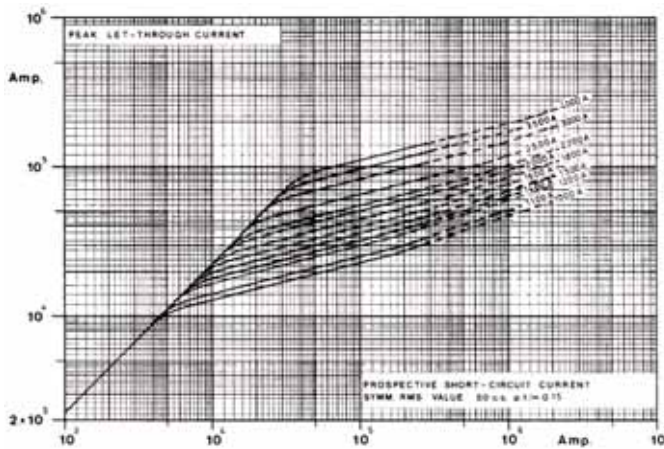

Peak Let-Through Curve

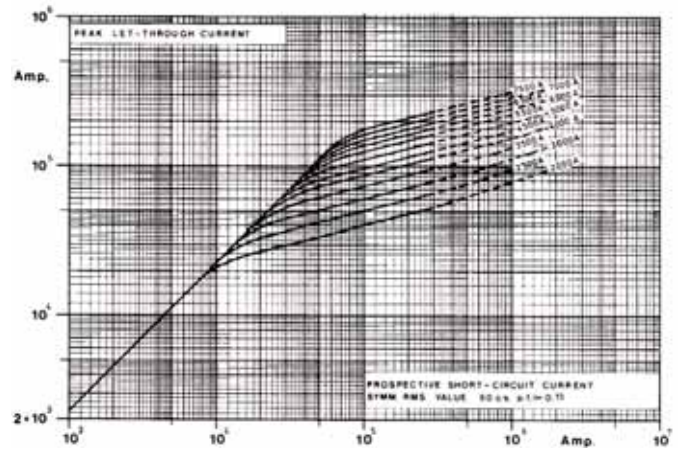

Data Sheet: Available upon request

Data Sheet: Available upon request

Square Body DIN 43 620 — 690V (IEC): 10-800A Class gR — Full Range Fuses

690V (IEC) 10-800A

Specifications

Description: Square body DIN 43 620 blade style high speed fuses.

Dimensions: See dimensions illustration.

Ratings:

Volts: — 690Vac (IEC)

Amps: — 10-800A

IR: — 300kA RMS Sym.

Agency Information: CE, Designed and tested to IEC 60269: Part 4, UL Recognized.

Electrical

Characteristics

Total clearing I^2t

The total clearing I^2t at rated voltage and at power factor of 15% are given in the electrical characteristics. For other voltages, the clearing I^2t is found by multiplying by correction factor, K, given as a function of applied working voltage, E_g , (rms).

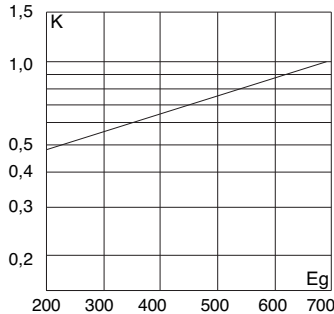

Arc Voltage

This curve gives the peak arc voltage, U_L , which may appear across the fuse during its operation as a function of the applied working voltage E_g , (rms) at a power factor of 15%.

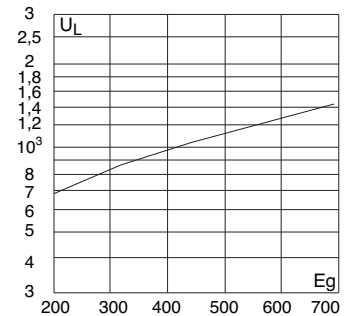

Power Losses

Watts loss at rated current is given in the electrical characteristics. The curve allows the calculation of the power losses at load currents lower than the rated current. The correction factor, K_p , is given as a function of the RMS load current, I_b , in % of the rated current.

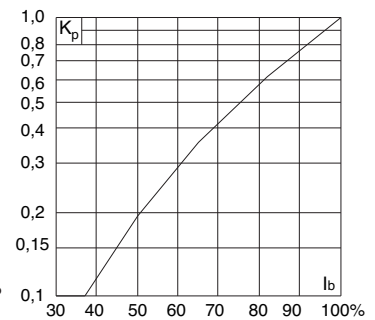

Features and Benefits

- Excellent DC performance
- Low arc voltage and low energy let-through (I^2t)
- Low watts loss
- Superior cycling capability

Typical Applications

- DC common bus
- DC drives
- Power converters/rectifiers
- Reduced voltage starters

For Operating Class aR Fuses in This Body Style

- See page 132

Dimensions (mm)

Type DIN 00, DIN 1, DIN 2, DIN 3

Size	A	B Max	D Max	E	F Min	H
00	49	78.5	60	30	35	15
1	68	135	66	52	40	20
2	68	150	74	60	48	25
3	68	150	89	75	60	32

1 mm = 0.0394" 1" = 25.4 mm

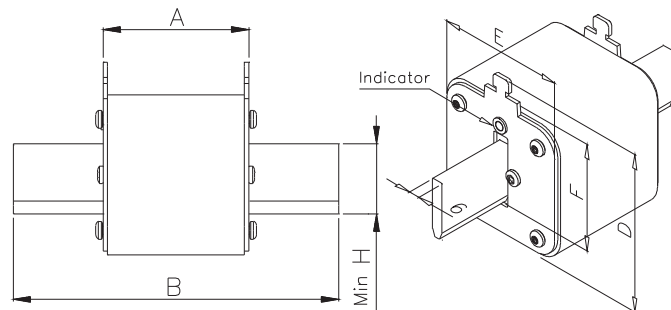

Square Body DIN 43 620 — 690V (IEC): 10-800A Class gR — Full Range Fuses

Catalog Numbers

Catalog Numbers Type T Indicator For Micro	Size	Electrical Characteristics			
		RMS Amp Rating*	Pt (A ² Sec)		Watts Loss
			Pre-arc	Clearing at 600V	
170M2691	00	10	3.8	20	3.5
170M2692		16	7.2	38	5.5
170M2693		20	13	70	6
170M2694		25	24	125	8
170M2695		32	53	275	9
170M2696		40	95	490	10
170M2697		50	185	1000	11
170M2698		63	345	1800	14
170M2699		80	695	3600	16
170M2700		100	1250	6650	19
170M2701		125	2300	12000	23
170M2702		160	4350	22500	29
170M4176	1	50	135	705	12
170M4177		63	245	1300	15
170M4178		80	500	2600	17
170M4179		100	950	4850	20
170M4180		125	1850	9500	23
170M4181		160	3450	18000	28
170M4182		200	6750	34500	31
170M4183		250	13500	70500	35
170M4184		315	26000	135000	41
170M4185		350	34000	175000	45
170M4186		400	48500	250000	48
170M5881		2	200	5650	29000
170M5882	250		10000	52500	40
170M5883	315		19500	105000	46
170M5884	350		26000	135000	50
170M5885	400		39500	205000	53
170M5886	450		55500	290000	59
170M5887	500		73000	375000	66
170M5888	550		100000	515000	70
170M5889	630		150000	770000	79
170M6080	3	350	23000	120000	55
170M6081		400	34000	175000	59
170M6082		450	48500	250000	62
170M6083		500	64000	330000	67
170M6084		550	84500	435000	70
170M6085		630	125000	645000	85
170M6086		700	160000	840000	93
170M6087		800	245000	1300000	99

*The RMS amp rating of this fuse range is given with open fuse bases connected to copper conductors according to IEC 60269, Part 1, table 10. When used in enclosed fuse bases/ disconnects, derating factors have to be observed.

Please contact Cooper Bussmann for application assistance.

- Watts loss provided at rated current.
- Microswitch ordered separately. See accessories on page 185-186.
- For fuse curves see pages 142 and 143.

High Speed Fuses

Square Body Size 00, 1 — 690V (IEC): 10-800A Class gR — Full Range Fuses

Size 00 — 10-160A: 690V
Time-Current Curve

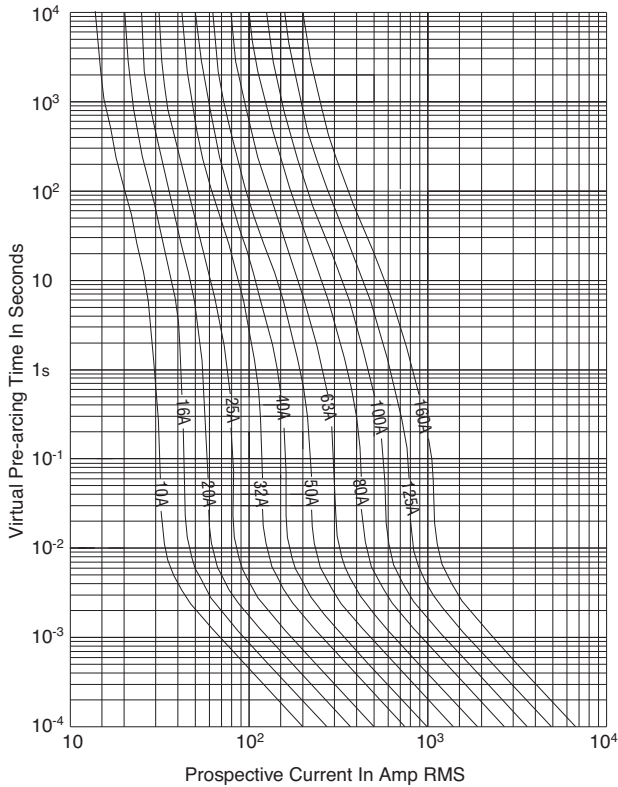

Size 1 — 50-400A: 690V
Time-Current Curve

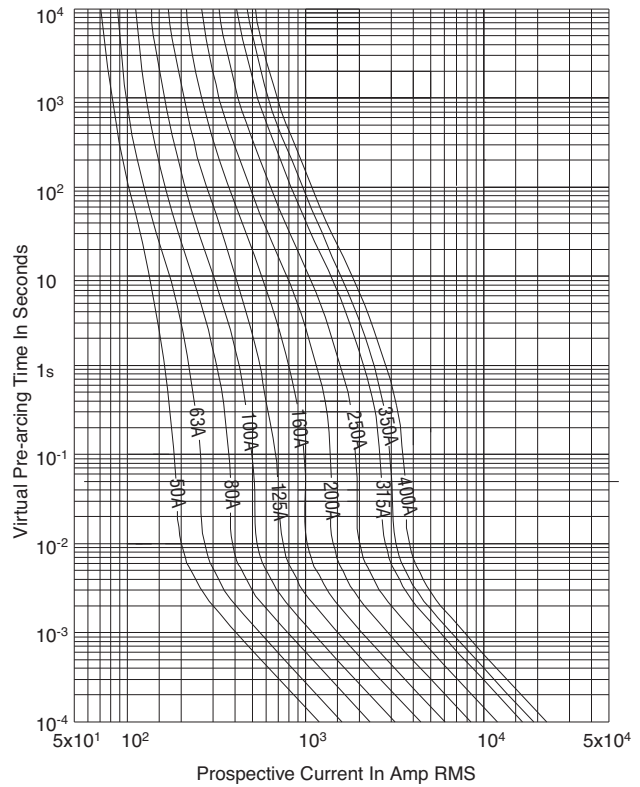

Peak Let-Through Curve

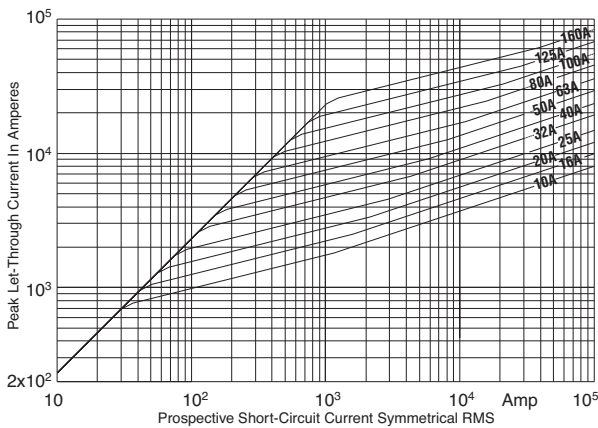

Peak Let-Through Curve

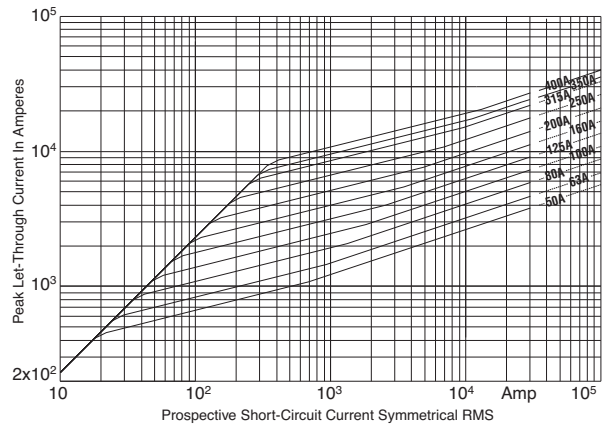

Square Body Size 2, 3 — 690V (IEC): 10-800A Class gR — Full Range Fuses

Size 2 — 200-630A: 690V
Time-Current Curve

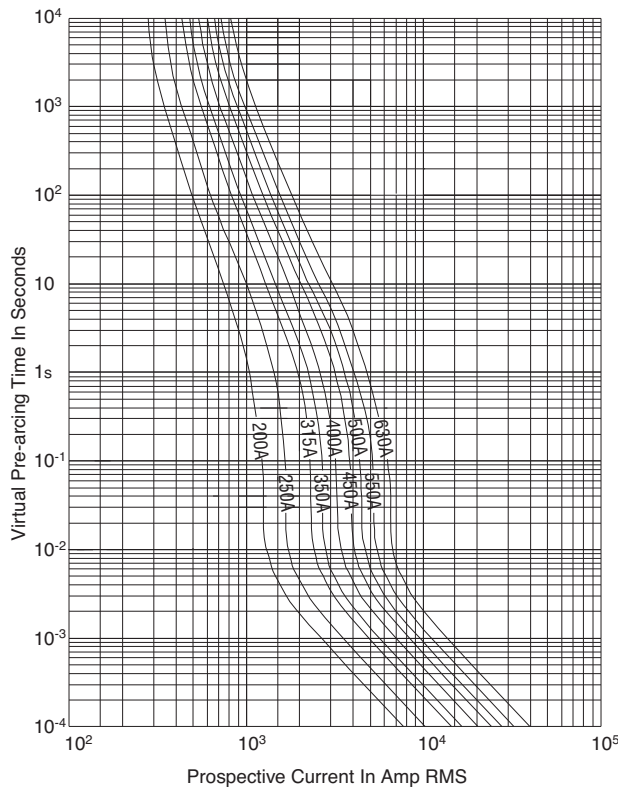

Size 3 — 350-800A: 690V
Time-Current Curve

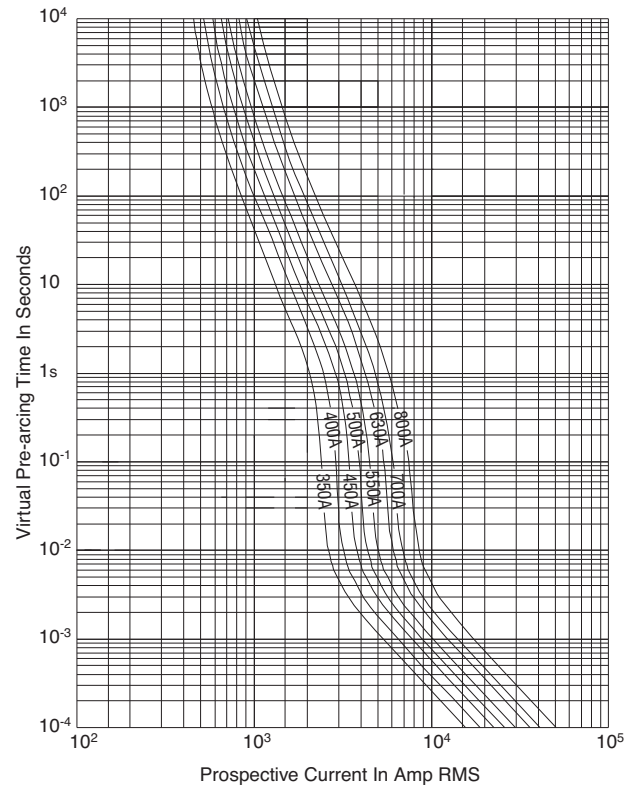

High Speed Fuses

Peak Let-Through Curve

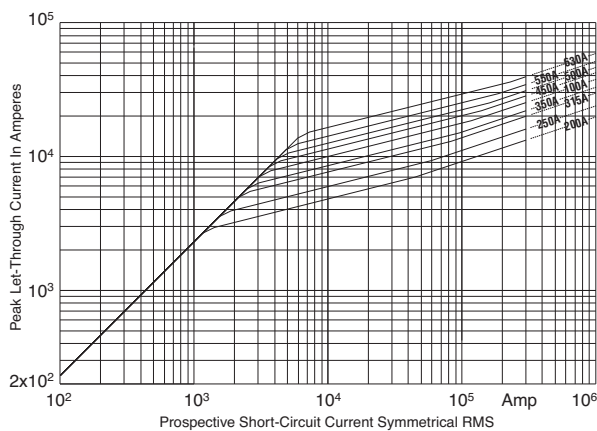

Peak Let-Through Curve

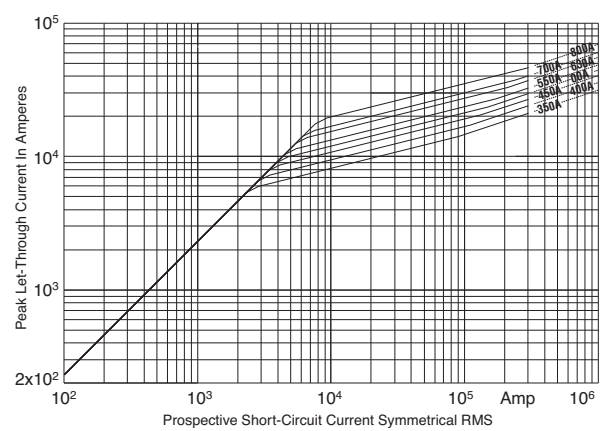

Square Body DIN 43 653 — 1000V (IEC): 20-315A

1000V (IEC) 20-315A

Specifications

Description: Square body DIN 43 653 stud-mount high speed fuses.

Dimensions: See dimensions illustration.

Ratings:

- Volts: — 1000Vac (20-250A)
- 900Vac (315A)
- Amps: — 20-315A
- IR: — 150kA RMS Sym.

Agency Information: CE, Designed and tested to IEC 60269: Part 4, UL Recognized.

Electrical Characteristics

Total clearing I^2t

The total clearing I^2t at rated voltage and at power factor of 15% are given in the electrical characteristics. For other voltages, the clearing I^2t is found by multiplying by correction factor, K, given as a function of applied working voltage, E_g , (rms).

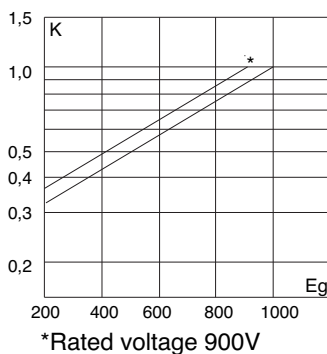

Arc Voltage

This curve gives the peak arc voltage, U_L , which may appear across the fuse during its operation as a function of the applied working voltage E_g , (rms) at a power factor of 15%.

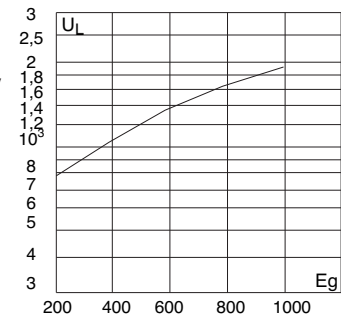

Power Losses

Watts loss at rated current is given in the electrical characteristics. The curve allows the calculation of the power losses at load currents lower than the rated current. The correction factor, K_p , is given as a function of the RMS load current, I_b , in % of the rated current.

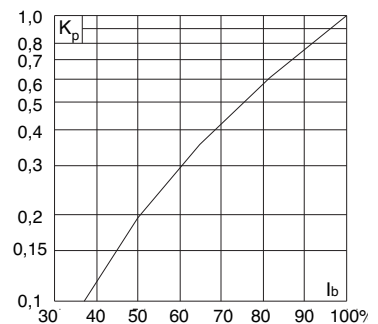

Features and Benefits

- Excellent DC performance
- Low arc voltage and low energy let-through (I^2t)
- Low watts loss
- Superior cycling capability

Typical Applications

- DC common bus
- DC drives
- Power converters/rectifiers
- Reduced voltage starters

For Other Voltage Ratings in This Body Style

- See page 117 (690V/700V)

Dimensions (mm)

Type 00TN/80 – 00/80

Size	Max A	B	C	D	Max E	F	G	H
00/80	54	98	78	51	30	28	10	
00TN/80	54	98	78	51	30	28	67	10

1mm = 0.0394" / 1" = 25.4mm

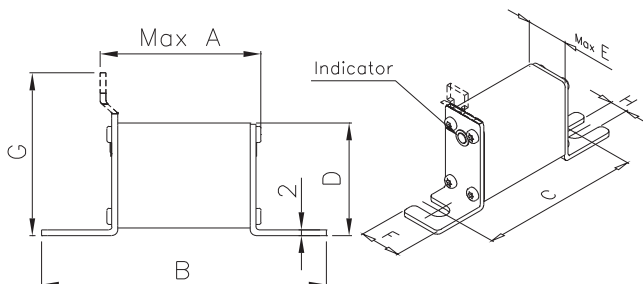

Square Body DIN 43 653 — 1000V (IEC): 20-315A

Catalog Numbers

Catalog Numbers		Size	Rated Voltage	Rated Current RMS Amps	Pt (A ² Sec)		Watts Loss
00/80 Visual Indicator for Micro	00TN/80 Type T Indicator for Micro				Pre-arc	Clearing at Rated Voltage	
170M4802	170M4822						
170M4803	170M4823	1000	25	30	210	7	
170M4804	170M4824	1000	32	55	390	9	
170M4805	170M4825	1000	35	69	500	10	
170M4806	170M4826	1000	40	100	690	11	
170M4807	170M4827	1000	50	170	1200	13	
170M4808	170M4828	1000	63	280	2000	18	
170M4809	170M4829	1000	80	500	3500	22	
170M4810	170M4830	1000	100	950	6850	25	
170M4811	170M4831	1000	125	1500	11500	33	
170M4812	170M4832	1000	160	3000	22000	37	
170M4813	170M4833	1000	200	5600	40500	40	
170M4814	170M4834	1000	250	10000	74000	48	
170M4815	170M4835	900	315	18000	115000	58	

- Watts loss provided at rated current.
- Microswitch ordered separately. See accessories on page 185-186.

Size 00 — 20-315A: 1000V Time-Current Curve

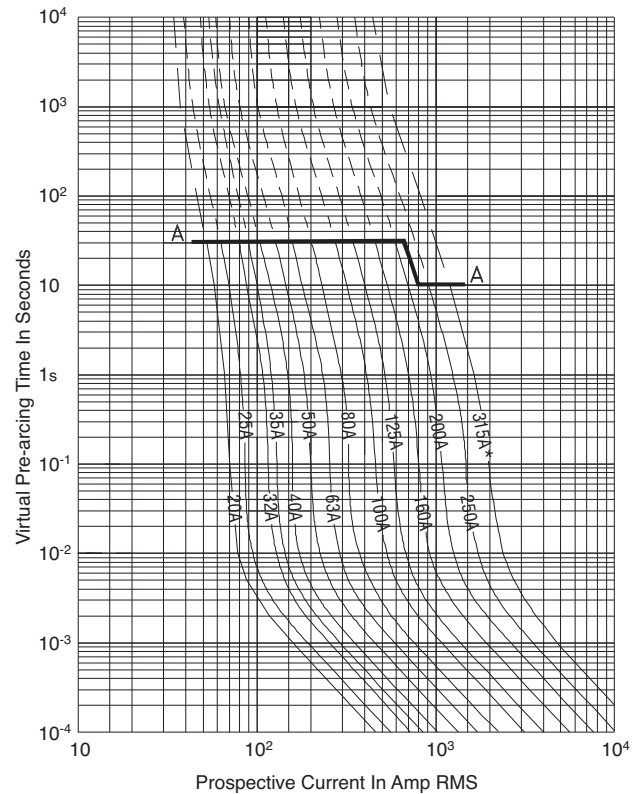

High Speed Fuses

Peak Let-Through Curve

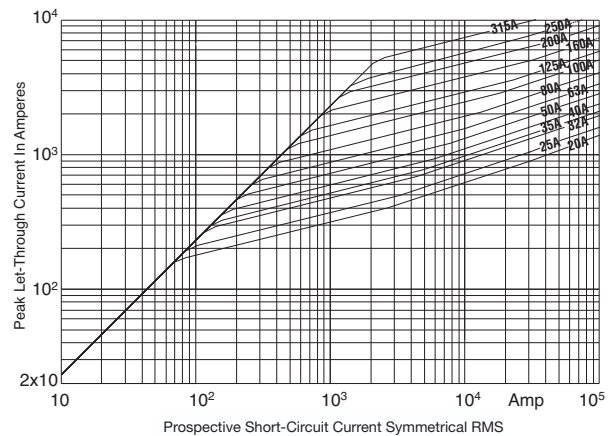

* 315A fuse is derated to 900V

Square Body DIN 43 653 — 1000V (IEC): 50-1400A

1000V (IEC) 50-1400A

Specifications

Description: Square body mount high speed fuses.

Dimensions: See dimensions illustrations.

Ratings:

Volts: — 1000Vac.

Amps: — 50-1400A

IR: — 150kA RMS Sym.

Agency Information: CE, Designed and tested to IEC 60269: Part 4, UL Recognized.

Electrical Characteristics

Total clearing I²t

The total clearing I²t at rated voltage and at power factor of 15% are given in the electrical characteristics. For other voltages, the clearing I²t is found by multiplying by correction factor, K, given as a function of applied working voltage, E_g, (rms).

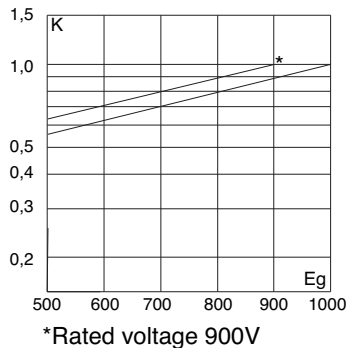

Arc Voltage

This curve gives the peak arc voltage, U_L, which may appear across the fuse during its operation as a function of the applied working voltage E_g, (rms) at a power factor of 15%.

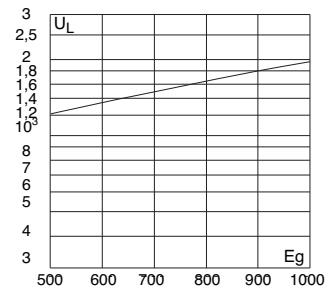

Power Losses

Watts loss at rated current is given in the electrical characteristics. The curve allows the calculation of the power losses at load currents lower than the rated current. The correction factor, K_p, is given as a function of the RMS load current, I_b, in % of the rated current.

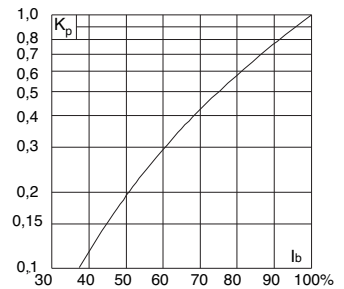

Features and Benefits

- Excellent DC performance
- Low arc voltage and low energy let-through (I²t)
- Low watts loss
- Superior cycling capability

Typical Applications

- DC common bus
- DC drives
- Power converters/rectifiers
- Reduced voltage starters

For Other Voltage Ratings in This Body Style

- See pages 122 (690V/700V) and 160 (1250V/1300V)

Dimensions (mm)

Type –KN/110

Size	A	B	C	Max D1	E	G	H	I
1*KN/110	80	138	108	61	43	6	22	11
1KN/110	80	138	108	69	51	6	25	11
2KN/110	80	138	108	77	59	6	25	11
3KN/110	81	139	108	92	74	6	30	11

Type –TN/110

Size	A	B	C	Max D2	E	G	H	I
1*TN/110	80	138	108	61	43	6	22	11
1TN/110	80	138	108	69	51	6	25	11
2TN/110	80	138	108	75	59	6	25	11
3TN/110	81	139	108	90	74	6	30	11

1mm = 0.0394" / 1" = 25.4mm

Type-KN/110

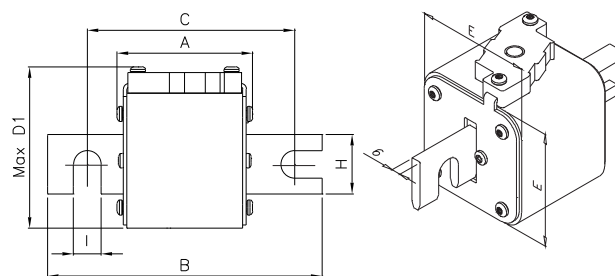

Type-TN/110

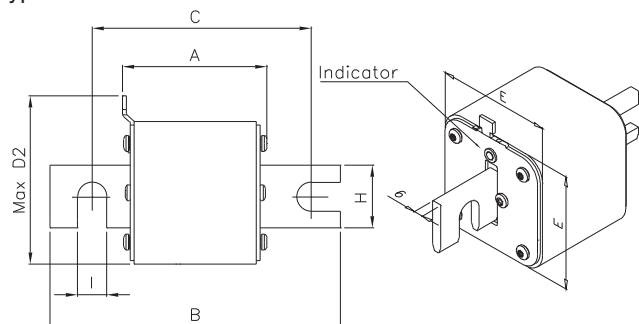

Square Body DIN 43 653 — 1000V (IEC): 50-1400A

Catalog Numbers

Catalog Numbers		Size	Rated Voltage	Electrical Characteristics			Watts Loss	
-KN/110 Type K Indicator for Micro	-TN/110 Type T Indicator for Micro			Rated Current RMS Amps	Pt (A ² Sec)			
					Pre-arc	Clearing at Rated Voltage		
170M3965	170M3981	1*	1000	50	135	815	20	
170M3966	170M3982		1000	63	215	1300	25	
170M3967	170M3983		1000	80	460	2750	30	
170M3968	170M3984		1000	100	860	5100	35	
170M3969	170M3985		1000	125	1450	8600	40	
170M3970	170M3986		1000	160	2850	17500	45	
170M3971	170M3987		1000	200	4950	29500	48	
170M3972	170M3988		1000	250	9550	57000	50	
170M3973	170M3989		1000	315	21500	130000	60	
170M3974	170M3990		1000	350	29000	175000	65	
170M3975	170M3991		1000	400	42000	250000	70	
170M4965	170M4980		1	1000	160	2200	13500	40
170M4966	170M4981			1000	200	4150	24500	45
170M4967	170M4982	1000		250	7750	46000	52	
170M4968	170M4983	1000		315	16500	98500	60	
170M4969	170M4984	1000		350	21500	130000	65	
170M4970	170M4985	1000		400	31000	185000	70	
170M4971	170M4986	1000		450	44500	265000	80	
170M4972	170M4987	1000		500	63000	375000	85	
170M4973	170M4988	1000		550	84500	500000	90	
170M4974	170M4989	1000		630	125000	755000	98	
170M5966	170M5981	2	1000	250	6750	40000	65	
170M5967	170M5982		1000	315	13500	81500	75	
170M5968	170M5983		1000	350	16500	99000	80	
170M5969	170M5984		1000	400	26000	155000	85	
170M5970	170M5985		1000	450	35500	210000	90	
170M5971	170M5986		1000	500	49500	295000	95	
170M5972	170M5987		1000	550	66000	390000	100	
170M5973	170M5988		1000	630	93500	555000	110	
170M5974	170M5989		1000	700	130000	770000	115	
170M5975	170M5990		1000	800	195000	1200000	125	
170M8614	170M8629	3	1000	315	9200	54500	90	
170M8615	170M8630		1000	350	13000	77500	95	
170M8616	170M8631		1000	400	19000	115000	105	
170M8617	170M8632		1000	450	27000	160000	107	
170M8618	170M8633		1000	500	37500	225000	110	
170M8619	170M8634		1000	550	52000	310000	115	
170M8620	170M8635		1000	630	82500	490000	120	
170M8621	170M8636		1000	700	115000	700000	125	
170M8622	170M8637		1000	800	170000	1050000	135	
170M8623	170M8638		1000	900	250000	1500000	145	
170M8624	170M8639		1000	1000	340000	2050000	150	
170M8625	170M8640		1000	1100	460000	2750000	155	
170M8626	170M8641		1000	1250	575000	3400000	175	
170M8627	170M8642		900	1400	795000	4200000	185	

- Watts loss provided at rated current.
- Microswitch ordered separately. See accessories on page 185-186.
- For fuse curves see pages 152 and 153.

High Speed Fuses

Square Body Flush End Contact — 1000V (IEC): 50-1400A

1000V (IEC) 50-1400A

Specifications

Description: Square body flush end contact high speed fuses.

Dimensions: See dimensions illustration.

Ratings:

Volts: — 1000Vac.

Amps: — 50-1400A

IR: — 150kA (Est. 300kA) RMS Sym.

Agency Information: CE, Designed and tested to IEC 60269: Part 4, UL Recognized.

Electrical Characteristics

Total clearing I^2t

The total clearing I^2t at rated voltage and at power factor of 15% are given in the electrical characteristics. For other voltages, the clearing I^2t is found by multiplying by correction factor, K, given as a function of applied working voltage, E_g , (rms).

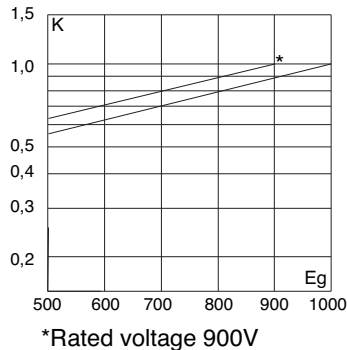

Arc Voltage

This curve gives the peak arc voltage, U_L , which may appear across the fuse during its operation as a function of the applied working voltage E_g , (rms) at a power factor of 15%.

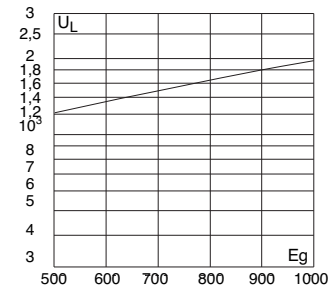

Power Losses

Watts loss at rated current is given in the electrical characteristics. The curve allows the calculation of the power losses at load currents lower than the rated current. The correction factor, K_p , is given as a function of the RMS load current, I_b , in % of the rated current.

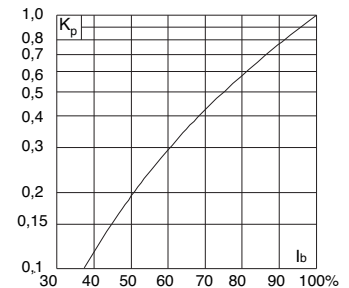

Features and Benefits

- Excellent DC performance
- Low arc voltage and low energy let-through (I^2t)
- Low watts loss
- Superior cycling capability

Typical Applications

- DC common bus
- DC drives
- Power converters/rectifiers
- Reduced voltage starters

For Other Voltage Ratings in This Body Style

- See pages 124 (690V/700V) and 162 (1250V/1300V)

Dimensions (mm)

Type -BKN/- and -GKN/-

Size	A	B	Max D	E	F	F* (in)	Min G	H
1*BKN/75+GKN/75	72.5	74	61	43	M8	5/16" - 18 UNC-2B	5	ø17.5
1BKN/75+GKN/75	73.2	74	69	52	M8	5/16" - 18 UNC-2B	8	ø20
2BKN/75+GKN/75	73.2	74.4	77	59	M10	3/8" - 16 UNC-2B	10	ø24
3BKN/75+GKN/75	73.3	75.4	92	74	M12	1/2" - 13 UNC-2B	10	ø30
3BKN/90+GKN/90	80.3	91.4	92	74	M12	1/2" - 13 UNC-2B	10	ø30

* Valid for fuses type -GKN/-.

1mm = 0.0394" / 1" = 25.4mm

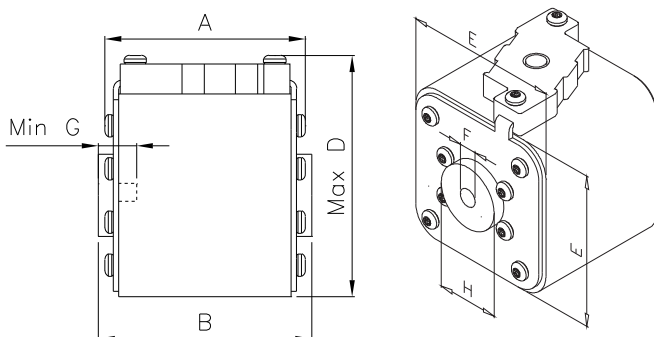

Square Body Flush End Contact — 1000V (IEC): 50-1400A

Catalog Numbers

Catalog Numbers		Electrical Characteristics					
-BKN- Type K Indicator for Micro	-GKN- Type K Indicator for Micro	Size	Rated Voltage	Rated Current RMS-Amps	I ² t (A ² Sec)		Watts Loss
					Pre-arc	Clearing at Rated Voltage	
170M3951	170M3921	1*	1000	50	135	815	20
170M3952	170M3922		1000	63	215	1300	25
170M3953	170M3923		1000	80	460	2750	30
170M3954	170M3924		1000	100	860	5100	35
170M3955	170M3925		1000	125	1450	8600	40
170M3956	170M3926		1000	160	2850	17500	45
170M3957	170M3927		1000	200	4950	29500	48
170M3958	170M3928		1000	250	9550	57000	50
170M3959	170M3929		1000	315	21500	130000	60
170M3960	170M3930		1000	350	29000	175000	65
170M3961	170M3931	1000	400	42000	250000	70	
170M4951	170M4921	1	1000	160	2200	13500	40
170M4952	170M4922		1000	200	4150	24500	45
170M4953	170M4923		1000	250	7750	46000	52
170M4954	170M4924		1000	315	16500	98500	60
170M4955	170M4925		1000	350	21500	130000	65
170M4956	170M4926		1000	400	31000	185000	70
170M4957	170M4927		1000	450	44500	265000	80
170M4958	170M4928		1000	500	63000	375000	85
170M4959	170M4929		1000	550	84500	500000	90
170M4960	170M4930		1000	630	125000	755000	98
170M5952	170M5922	2	1000	250	6750	40000	65
170M5953	170M5923		1000	315	13500	81500	75
170M5954	170M5924		1000	350	16500	99000	80
170M5955	170M5925		1000	400	26000	155000	85
170M5956	170M5926		1000	450	35500	210000	90
170M5957	170M5927		1000	500	49500	295000	95
170M5958	170M5928		1000	550	66000	390000	100
170M5959	170M5929		1000	630	93500	555000	110
170M5960	170M5930		1000	700	130000	770000	115
170M5961	170M5931		1000	800	195000	1200000	125
170M8600	170M8500	3	1000	315	9200	54500	90
170M8601	170M8501		1000	350	13000	77500	95
170M8602	170M8502		1000	400	19000	115000	105
170M8603	170M8503		1000	450	27000	160000	107
170M8604	170M8504		1000	500	37500	225000	110
170M8605	170M8505		1000	550	52000	310000	115
170M8606	170M8506		1000	630	82500	490000	120
170M8607	170M8507		1000	700	115000	700000	125
170M8608	170M8508		1000	800	170000	1050000	135
170M8609	170M8509		1000	900	250000	1500000	145
170M8610	170M8510		1000	1000	340000	2050000	150
170M8611	170M8511		1000	1100	460000	2750000	155
170M8612**	170M8512**		1000	1250	575000	3400000	175
170M8613**	170M8513**	900	1400	795000	4200000	185	

**Overall length is 90mm, for all other fuses the overall length is 75mm.
 • Watts loss provided at rated current.
 • Microswitch ordered separately. See accessories on page 185-186.
 • For fuse curves see pages 152 and 153.

High Speed Fuses

Square Body US style — 1000V (IEC): 50-1400A

1000V (IEC) 50-1400A

Specifications

Description: Square body US style high speed fuses.

Dimensions: See dimensions illustration.

Ratings:

- Volts: — 1000Vac.
- Amps: — 50-1400A
- IR: — 150kA RMS Sym.

Agency Information: CE, Designed and tested to IEC 60269: Part 4, UL Recognized.

Electrical Characteristics

Total clearing I^2t

The total clearing I^2t at rated voltage and at power factor of 15% are given in the electrical characteristics. For other voltages, the clearing I^2t is found by multiplying by correction factor, K, given as a function of applied working voltage, E_g , (rms).

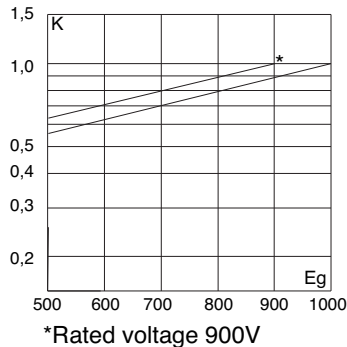

Arc Voltage

This curve gives the peak arc voltage, U_L , which may appear across the fuse during its operation as a function of the applied working voltage E_g , (rms) at a power factor of 15%.

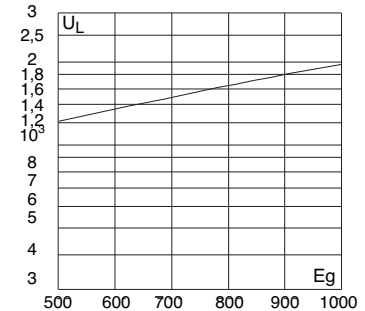

Power Losses

Watts loss at rated current is given in the electrical characteristics. The curve allows the calculation of the power losses at load currents lower than the rated current. The correction factor, K_p , is given as a function of the RMS load current, I_b , in % of the rated current.

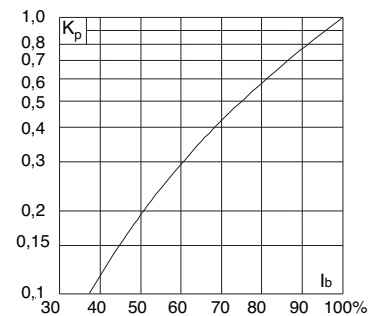

Features and Benefits

- Excellent DC performance
- Low arc voltage and low energy let-through (I^2t)
- Low watts loss
- Superior cycling capability

Typical Applications

- DC common bus
- DC drives
- Power converters/rectifiers
- Reduced voltage starters

For Other Voltage Ratings in This Body Style

- See pages 126 (690V/700V) and 164 (1250V/1300)

Dimensions (mm)

Type -FKE/115

Size	B	C1	C2	D	E	H	I
1*FKE/115	156	130	101	59	45	20	10
1FKE/115	160	127	102	69	53	25	14
2FKE/115	160	127	102	77	61	25	14
3FKE/115	159	128	101	92	76	36	16

1mm = 0.0394" / 1" = 25.4mm

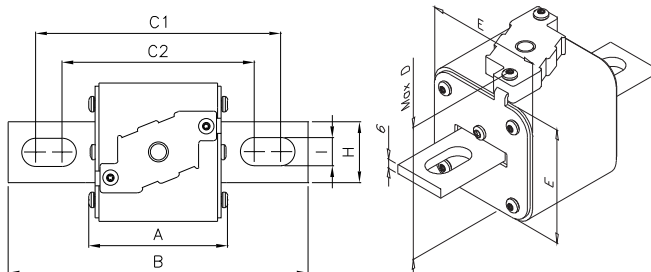

Square Body US style — 1000V (IEC): 50-1400A

Catalog Numbers

Catalog Numbers -FKE/115 Type K Indicator for Micro	Size	Electrical Characteristics			
		Rated Current RMS-Amps	I ² t (A ² Sec)		Watts Loss
			Pre-arc	Clearing at 1000V	
170M3531	1*	50	135	815	20
170M3532		63	215	1300	25
170M3533		80	460	2750	30
170M3534		100	860	5100	35
170M3535		125	1450	8600	40
170M3536		160	2850	17500	45
170M3537		200	4950	29500	48
170M3538		250	9550	57000	50
170M3539		315	21500	130000	60
170M3540		350	29000	175000	65
170M3541	400	42000	250000	70	
170M4531	1	160	2200	13500	40
170M4532		200	4150	24500	45
170M4533		250	7750	46000	52
170M4534		315	16500	98500	60
170M4535		350	21500	130000	65
170M4536		400	31000	185000	70
170M4537		450	44500	265000	80
170M4538		500	63000	375000	85
170M4539		550	84500	500000	90
170M4540		630	125000	755000	98
170M5531	2	250	6750	40000	65
170M5532		315	13500	81500	75
170M5533		350	16500	99000	80
170M5534		400	26000	155000	85
170M5535		450	35500	210000	90
170M5536		500	49500	295000	95
170M5537		550	66000	390000	100
170M5538		630	93500	555000	110
170M5539		700	130000	770000	115
170M5540		800	195000	1200000	125
170M8531	3	315	9200	54500	90
170M8532		350	13000	77500	95
170M8533		400	19000	115000	105
170M8534		450	27000	160000	107
170M8535		500	37500	225000	110
170M8536		550	52000	310000	115
170M8537		630	82500	490000	120
170M8538		700	115000	700000	125
170M8539		800	170000	1050000	135
170M8540		900	250000	1500000	145
170M8541		1000	340000	2050000	150
170M8542		1100	460000	2750000	155
170M8543		1250	575000	3400000	175
170M8544*		1400	795000	4200000*	185

- * Rated voltage 900V.
- Watts loss provided at rated current.
- Microswitch ordered separately. See accessories on pages 185-186.
- For fuse curves see pages 152 and 153.

High Speed Fuses

Square Body Size 1*, 1 — 1000V (IEC): 50-1400A

Size 1* — 50-400A: 1000V
Time-Current Curve

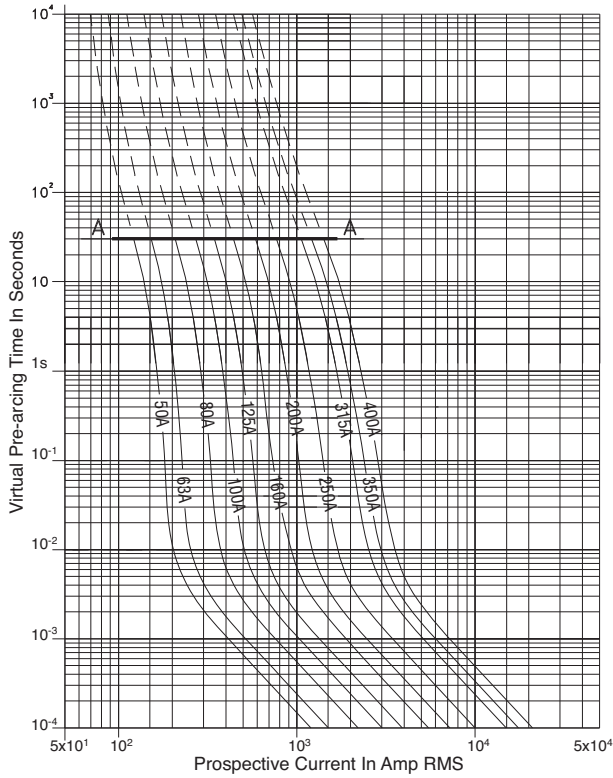

Size 1 — 160-630A: 1000V
Time-Current Curve

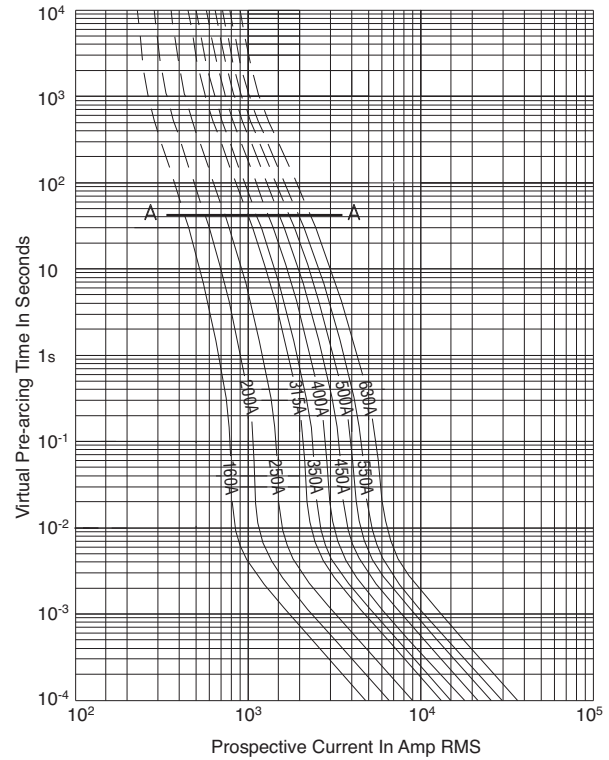

Peak Let-Through Curve

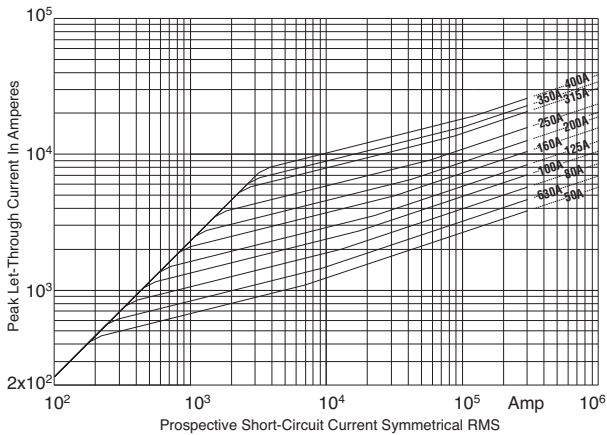

Peak Let-Through Curve

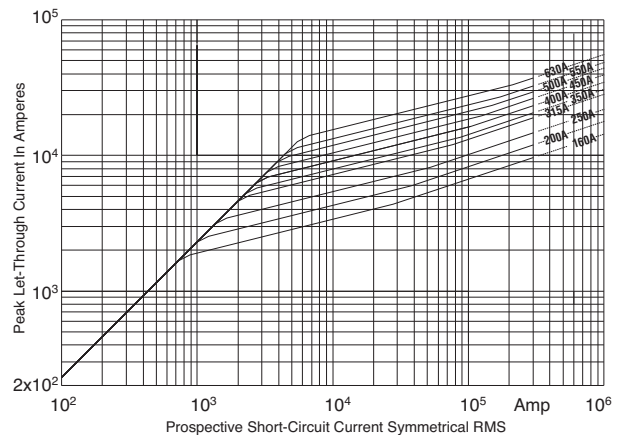

Square Body Size 2, 3 — 1000V (IEC): 50-1400A

Size 2 — 250-800A: 1000V
Time-Current Curve

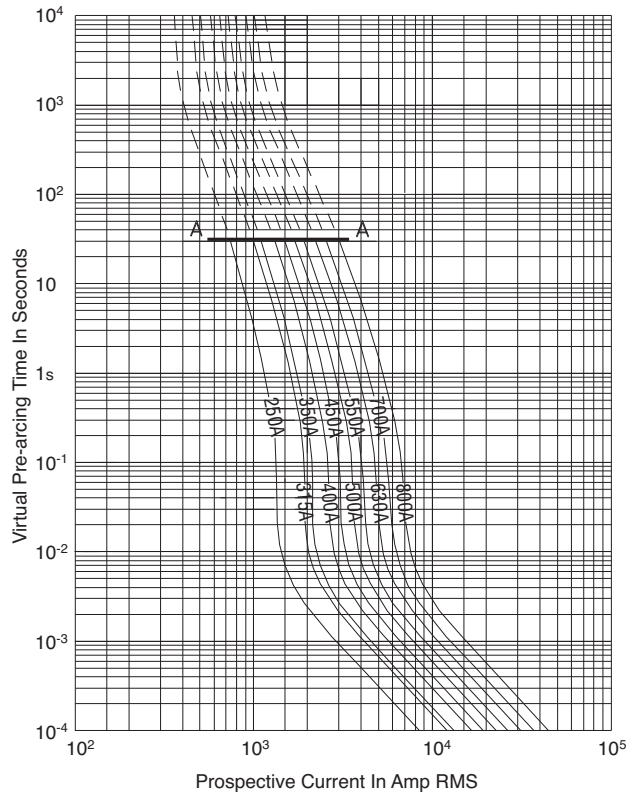

Size 3 — 315-1400A: 1000V
Time-Current Curve

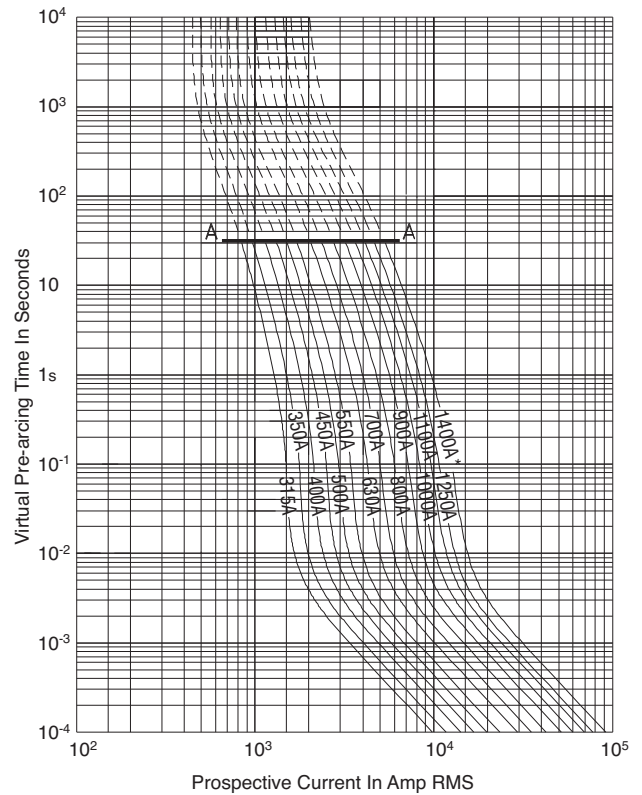

High Speed Fuses

Peak Let-Through Curve

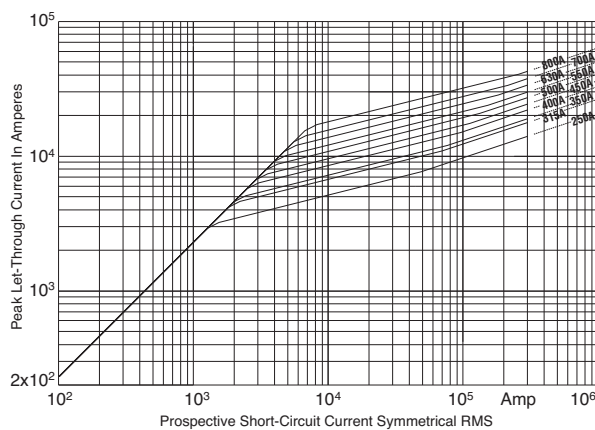

Peak Let-Through Curve

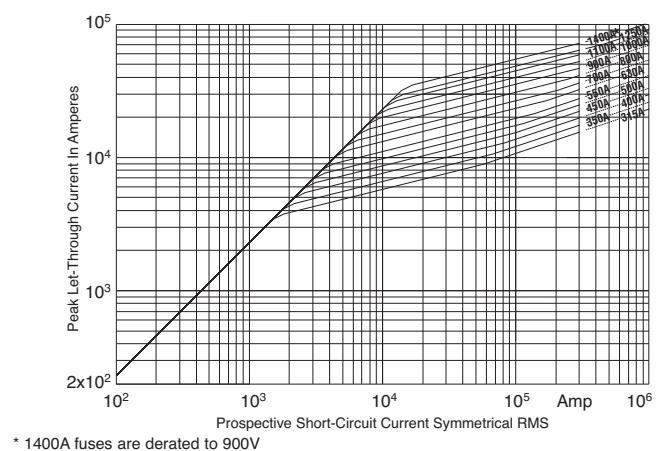

Square Body Flush End Contact Size 4 — 1000V (IEC): 1000-2700A

1000V (IEC) 1000-2700A

Specifications

Description: Square body DIN 43 620 blade style high speed fuses.

Dimensions: See dimensions illustration.

Ratings:

Volts: — 1000Vac (IEC)

Amps: — 1000-2700A

IR: — 125kA RMS Sym.

Agency Information: CE, Designed and tested to IEC 60269: Part 4, UL Recognized.



Electrical Characteristics

Total clearing I²t

The total clearing I²t at rated voltage and at power factor of 15% are given in the electrical characteristics. For other voltages, the clearing I²t is found by multiplying by correction factor, K, given as a function of applied working voltage, E_G, (rms).

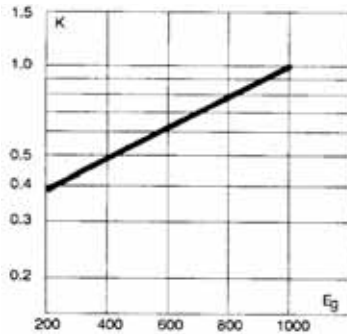

Arc Voltage

This curve gives the peak arc voltage, U_L, which may appear across the fuse during its operation as a function of the applied working voltage E_G, (rms) at a power factor of 15%.

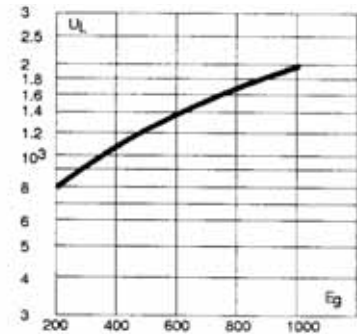

Power Losses

Watts loss at rated current is given in the electrical characteristics. The curve allows the calculation of the power losses at load currents lower than the rated current. The correction factor, K_p, is given as a function of the RMS load current, I_b, in % of the rated current.

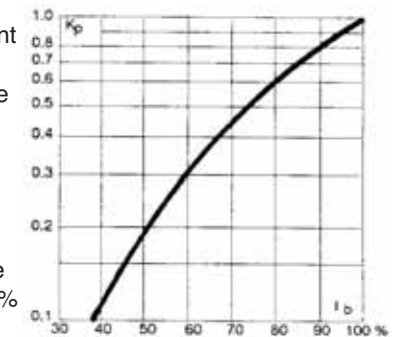

Features and Benefits

- Excellent DC performance
- Low arc voltage and low energy let-through (I²t)
- Low watts loss
- Superior cycling capability

Typical Applications

- DC common bus
- DC drives
- Power converters/rectifiers
- Reduced voltage starters

For Other Voltage Ratings in This Body Style

- See pages 135 (690V/700V) and 168 (1250V)

Catalog Numbers

Fuse Size	Catalog Number		Electrical Characteristics				
	-BKN/95 Type K Indicator	-SBKN/90 Type K Indicator	Rated Voltage (V)	Rated Current RMS-Amp	I ² t (A ² Sec)		Watt Loss (W)
					Pre-arc	Clearing at 1000V	
4		170M7542	1000	1000	180000	1100000	195
		170M7031		1100	250000	1500000	200
	170M7636	170M7548		1500	600000	3600000	250
	170M7639	170M7034		1700	850000	5000000	260
	170M7963	170M7544		2000	1450000	8600000	270
	170M7090	170M7035		2200	2000000	12000000	280
	170M7640	170M7036		2500	3000000	18000000	295
	170M7658	170M7037		2700	3700000	22000000	310

Square Body Flush End Contact Size 4 — 1000V (IEC): 1000-2700A

Flush End Contact - Size 4

1000V : 1000 – 2700A

Dimensions (mm):

Type 4BKN/95

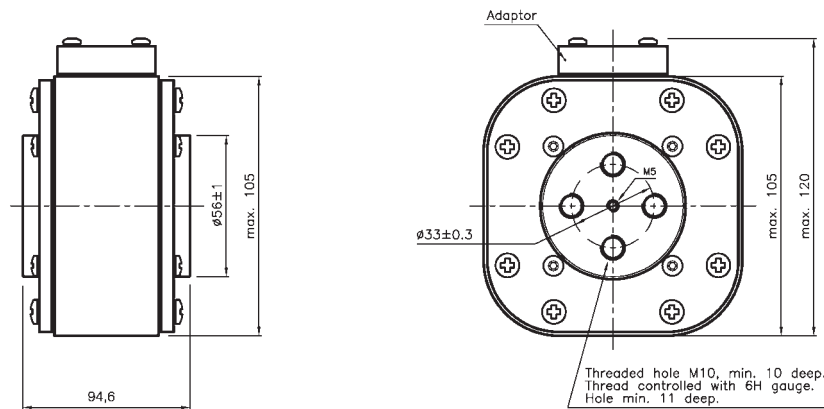

Type 4SBKN/95

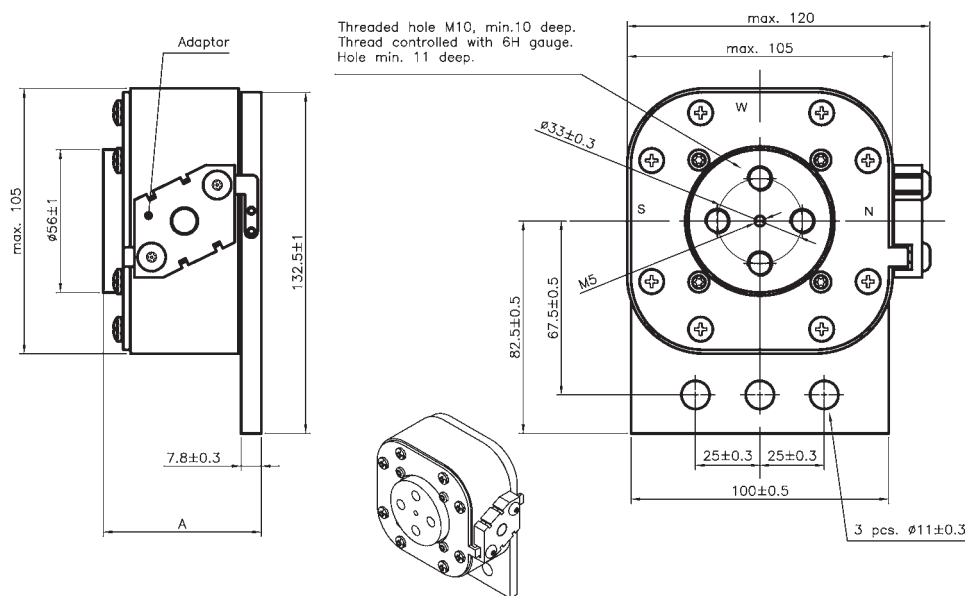

High Speed Fuses

Square Body Flush End Contact Size 4 — 1000V (IEC): 1000-2700A

Size 4 — 1000-2700A: 660V
Time-Current Curve

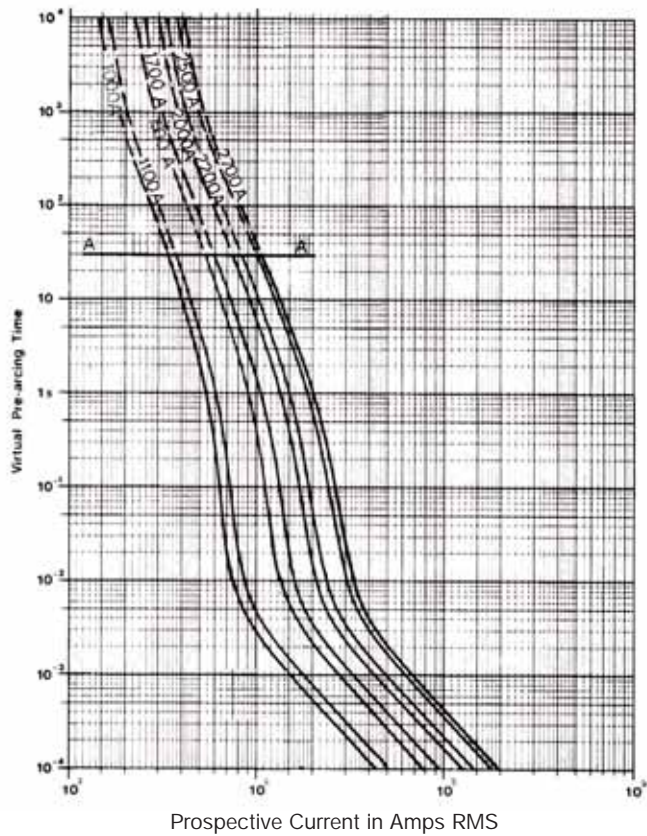

Peak Let-Through Curve

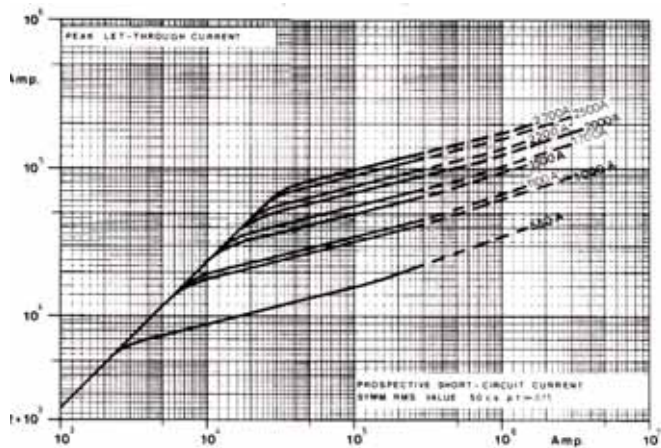

Data Sheet: Available upon request

Square Body Flush End Contact Size 24 — 1000V (IEC): 2000-5000A

1000V (IEC) 2000-5000A

Specifications

Description: High speed square body fuses, for the protection of the power rectifier section of the equipment.

Dimensions: See dimensions illustration.

Ratings:

Volts: — 1000Vac

Amps: — 2000-5000A

IR: — 300kA RMS Sym.

Agency Information: CE, Designed and tested to IEC 60269: Part 4, UL Recognized.



Electrical Characteristics

Total clearing I^2t

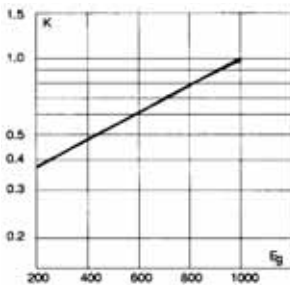

2000-3500A

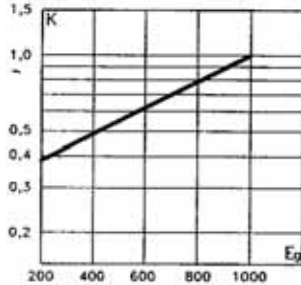

4200-5000A

The total clearing I^2t at rated voltage and at power factor of 15% are given in the electrical characteristics. For other voltages, the clearing I^2t is found by multiplying by correction factor, K, given as a function of applied working voltage, E_g , (rms).

Features and Benefits

- Low watts loss
- Superior cycling capability

Typical Applications

- Power converters/rectifiers
- Reduced voltage starters

Arc Voltage

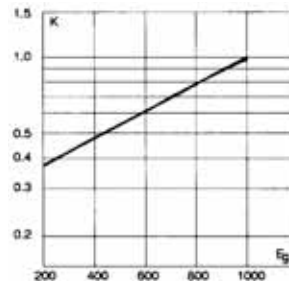

2000-3500A

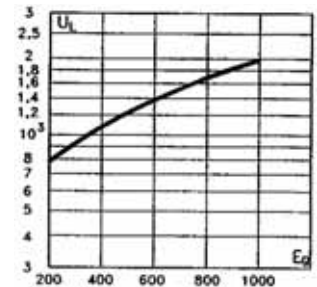

4200-5000A

This curve gives the peak arc voltage, U_L , which may appear across the fuse during its operation as a function of the applied working voltage E_g , (rms) at a power factor of 15%.

Power Losses

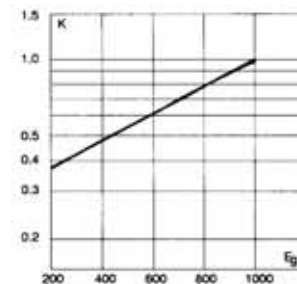

2000-3500A

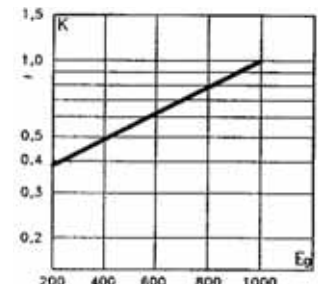

4200-5000A

Watts loss at rated current is given in the electrical characteristics. The curve allows the calculation of the power losses at load currents lower than the rated current. The correction factor, K_p , is given as a function of the RMS load current, I_b , in % of the rated current.

For Other Voltage Ratings in This Body Style

- See pages 137 (660V) and 171 (1250V)

Square Body Flush End Contact Size 24 — 1000V (IEC): 2000-5000A

Catalog Numbers

Fuse Size	Cat. Number	Rated Voltage (V)	Rated Current RMS-Amp	Electrical Characteristics		Watt Loss (W)
				I^2t (A ² Sec)		
				Pre-arc	Clearing at 1000V	
24	170M7608	1000	2000	885000	5700000	345
	170M7680		3000	2900000	19000000	430
	170M7567		3200	3300000	20000000	440
	170M7568		3500	4500000	27000000	450
	170M7569		4000	6800000	40000000	475
	170M7498		4200	8000000	47500000	485
	170M7488		4500	10000000	59000000	495
	170M7622		5000	14000000	82500000	540

Data Sheet: 170K7540, 170K8514

Dimensions (mm):

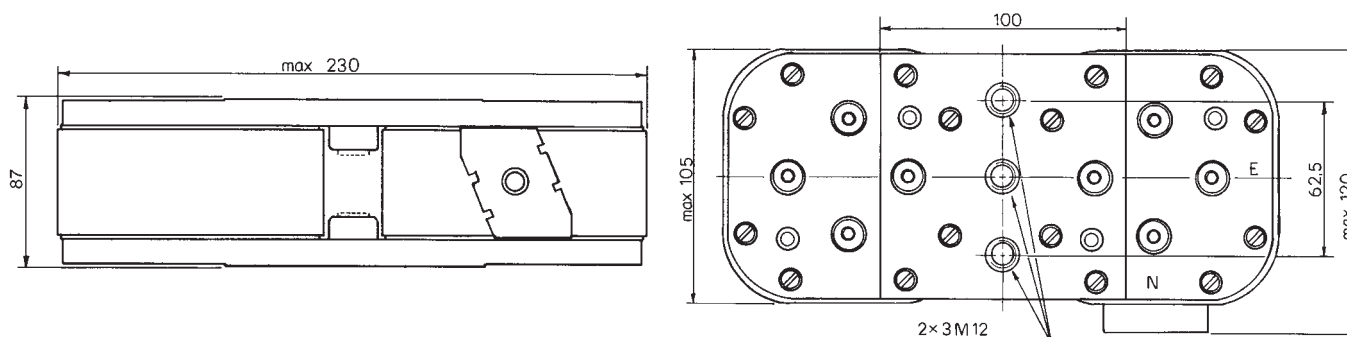

Square Body Flush End Contact Size 24 — 1000V (IEC): 2000-5000A

Size 24 — 2000-3500A: 1000V
Time-Current Curve

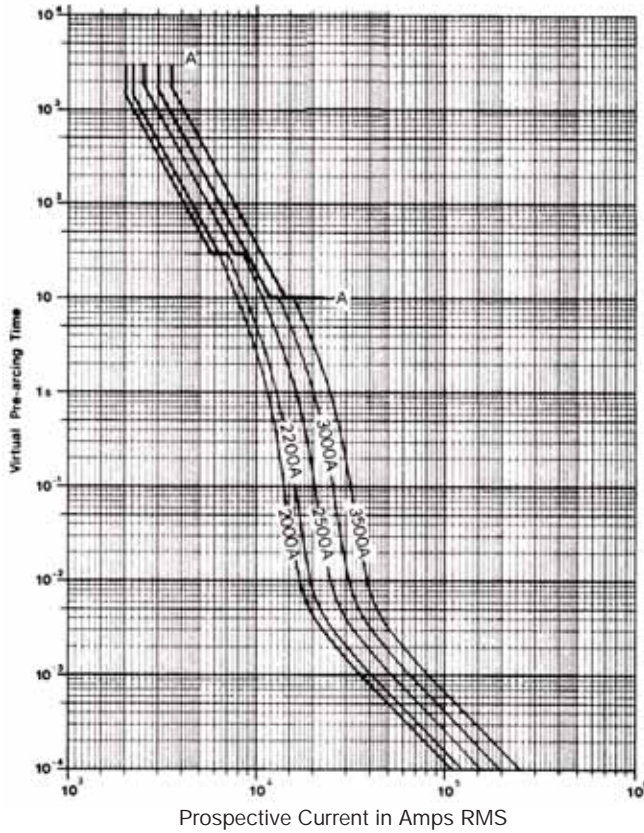

Size 24 — 4200-5000A: 1000V
Time-Current Curve

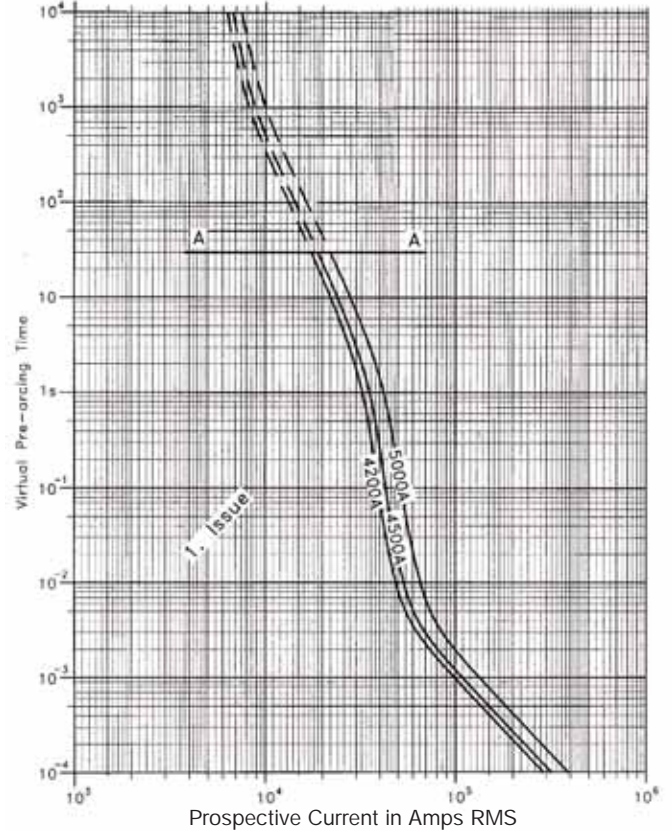

High Speed Fuses

Peak Let-Through Curve

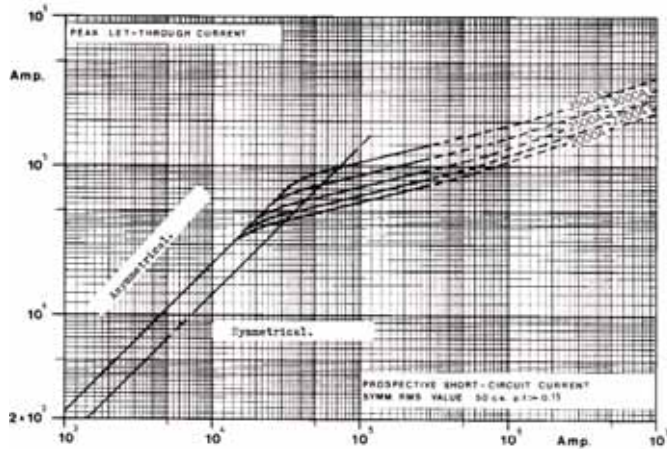

Peak Let-Through Curve

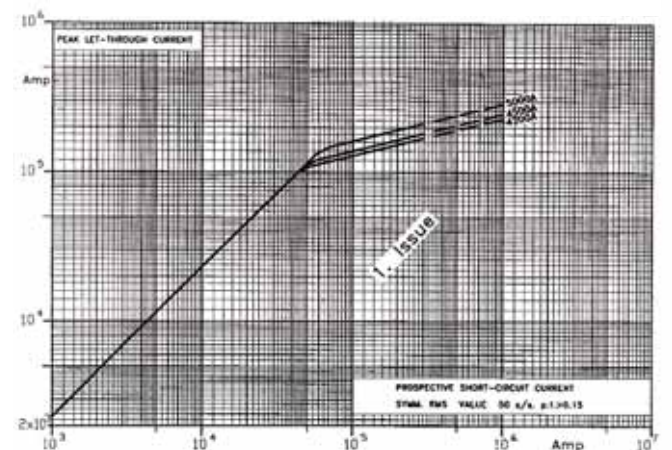

Data Sheet: Available upon request

Data Sheet: Available upon request

Square Body DIN 43 653 — 1250V/1300V (IEC/UL): 50-1400A

1250V/1300V (IEC/UL) 50-1400A

Specifications

Description: Square body DIN 43 653 stud-mount high speed fuses.

Dimensions: See dimensions illustration.

Ratings:

Volts: — 1250Vac (IEC)
— 1300Vac (UL)

Amps: — 50-1400A

IR: — 100kA RMS Sym.

Agency Information: CE, Designed and tested to IEC 60269: Part 4, UL Recognized. Consult Cooper Bussmann for UL Recognition/CSA Component Acceptance status.

Electrical Characteristics

Total Clearing I^2t

The total clearing I^2t at rated voltage and at power factor of 15% are given in the electrical characteristics. For other voltages, the clearing I^2t is found by multiplying by correction factor, K , given as a function of applied working voltage, E_g , (rms).

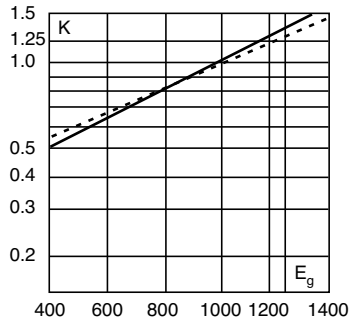

Dashed lines (-----) apply to the following amperages:.

Size	Amps.
1*	400A
1	500-630A
2	630-1000A
3	800-1400A



Arc Voltage

This curve gives the peak arc voltage, U_L , which may appear across the fuse during its operation as a function of the applied working voltage, E_g , (rms) at a power factor of 15%.

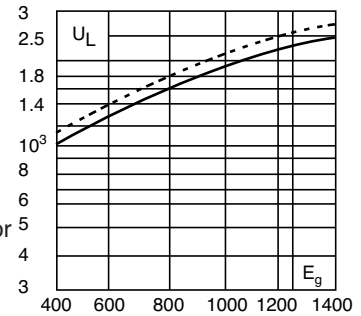

Power Losses

Watts loss at rated current is given in the electrical characteristics. The curve allows the calculation of the power losses at load currents lower than the rated current. The correction factor, K_p , is given as a function of the RMS load current, I_b , in % of the rated current.

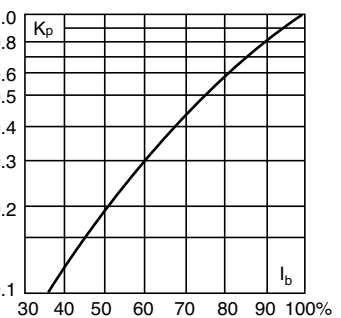

Features and Benefits

- Excellent DC performance
- Low arc voltage and low energy let-through (I^2t)
- Low watts loss
- Superior cycling capability

Typical Applications

- DC common bus
- DC drives
- Power converters/rectifiers
- Reduced voltage starters

For Other Voltage Ratings in This Body Style

- See pages 122 (690V/700V) and 146 (1000V)

Dimensions (mm)

Type -/110, -TN/110

Size	A	B	D**	E	H
1*	80	138	58	45	20
1	80	138	66	53	25
2	80	138	75	61	25
3	81	139	90	76	30

**Microswitch.

1mm = 0.0394" / 1" = 25.4mm

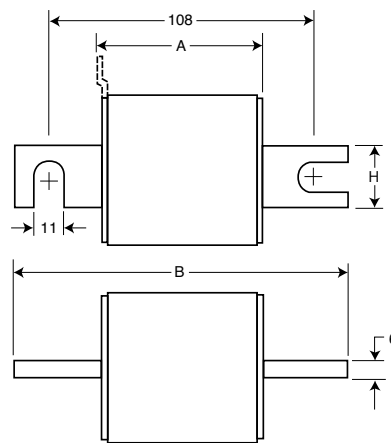
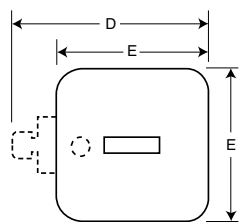

Dimensions (mm)

Type -KN/110

Size	A	B	D	E	H
1*	80	138	58	45	20
1	80	138	66	53	25
2	80	138	75	61	25
3	81	139	90	76	30

1mm = 0.0394" / 1" = 25.4mm

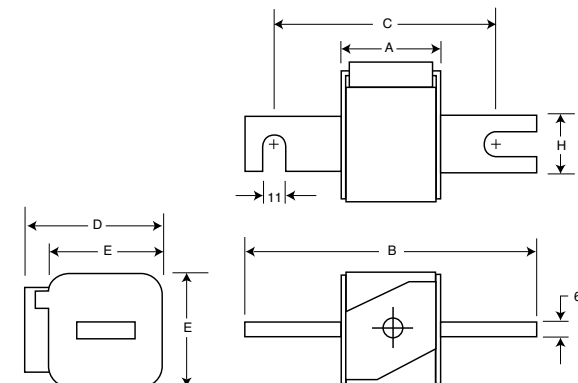

Square Body DIN 43 653 — 1250V/1300V (IEC/UL): 50-1400A

Catalog Numbers

Catalog Numbers			Size	Electrical Characteristics				Watts Loss
-I110 Visual Indicator	-TN/110 Type T Indicator for Micro	-KN/110 Type K Indicator for Micro		Rated Current RMS-Amps	I ² t (A ² Sec)			
					Pre-arc	Clearing at 1000V	Clearing at 1250V	
170M3138	170M3188	170M3238	1*	50	135	815	1100	15
170M3139	170M3189	170M3239		63	215	1300	1750	20
170M3140	170M3190	170M3240		80	420	2500	3350	25
170M3141	170M3191	170M3241		100	750	4450	5950	30
170M3142	170M3192	170M3242		125	1450	9000	11500	35
170M3143	170M3193	170M3243		160	2600	16000	21000	40
170M3144	170M3194	170M3244		200	5150	31000	41000	45
170M3145	170M3195	170M3245		250	9200	54500	73000	55
170M3146	170M3196	170M3246		315	18500	115000	150000	60
170M3147	170M3197	170M3247		350	27000	165000	220000	65
170M3148	170M3198	170M3248	400	53000	265000	335000	70	
170M4138	170M4188	170M4238	1	160	1900	11500	15500	45
170M4139	170M4189	170M4239		200	3800	22500	30000	50
170M4140	170M4190	170M4240		250	7750	46000	61500	60
170M4141	170M4191	170M4241		315	15000	90000	120000	65
170M4142	170M4192	170M4242		350	20000	125000	165000	70
170M4143	170M4193	170M4243		400	29500	175000	235000	75
170M4144	170M4194	170M4244		450	42000	250000	335000	80
170M4145	170M4195	170M4245		500	69500	340000	435000	85
170M4146	170M4196	170M4246		550	95000	465000	590000	95
170M4147	170M4197	170M4247		630†	130000	660000		100
170M5138	170M5188	170M5238	2	250	6500	38500	51500	65
170M5139	170M5189	170M5239		280	9350	55500	74500	70
170M5140	170M5190	170M5240		315	13000	77500	105000	75
170M5141	170M5191	170M5241		350	16500	97500	135000	80
170M5142	170M5192	170M5242		400	23000	140000	180000	85
170M5143	170M5193	170M5243		450	34000	205000	270000	90
170M5144	170M5194	170M5244		500	48000	285000	380000	95
170M5145	170M5195	170M5245		550	62000	370000	495000	100
170M5146	170M5196	170M5246		630	115000	575000	730000	110
170M5147	170M5197	170M5247		700	160000	795000	1050000	115
170M5148	170M5198	170M5248	800	245000	1200000	1550000	120	
170M5149	170M5199	170M5249	900‡	360000	1750000		125	
170M5150	170M5200	170M5250	1000‡	480000	2350000		135	
170M6138	170M6188	170M6238	3	315	9500	58000	77500	85
170M6139	170M6189	170M6239		350	13500	81500	110000	90
170M6140	170M6190	170M6240		400	19500	120000	160000	95
170M6141	170M6191	170M6241		450	31000	185000	245000	100
170M6142	170M6192	170M6242		500	39000	235000	310000	105
170M6143	170M6193	170M6243		550	55000	325000	435000	110
170M6144	170M6194	170M6244		630	83500	495000	665000	115
170M6145	170M6195	170M6245		700	115000	705000	940000	120
170M6146	170M6196	170M6246		800‡	205000	995000	1300000	125
170M6147	170M6197	170M6247		900‡	305000	1500000	1900000	130
170M6148	170M6198	170M6248	1000‡	450000	2150000	2750000	135	
170M6149	170M6199	170M6249	1100‡	575000	2800000	3600000	140	
170M6150	170M6200	170M6250	1250‡	810000	3950000		145	
170M6151	170M6201	170M6251	1400‡	1250000	6000000		150	

†Rated voltage (IEC) 1100V.

‡Rated voltage (IEC) 1250V.

• Watts loss provided at rated current.

• Microswitch indicator ordered separately. See accessories on pages 185-186.

• For fuse curves see pages 166 and 167.

High Speed Fuses

Square Body Flush End Contact — 1250V/1300V (IEC/UL): 50-1400A

1250V/1300V (IEC/UL) 50-1400A

Specifications

Description: Square body flush end contact high speed fuses.

Dimensions: See dimensions illustrations.

Ratings:

- Volts: — 1250Vac (IEC)
- 1300Vac (UL)
- Amps: — 50-1400A
- IR: — 100kA RMS Sym.



Agency Information: CE, Designed and tested to IEC 60269: Part 4, UL Recognized. Consult Cooper Bussmann for UL Recognition/CSA Component Acceptance status.

Electrical Characteristics

Total Clearing I²t

The total clearing I²t at rated voltage and at power factor of 15% are given in the electrical characteristics. For other voltages, the clearing I²t is found by multiplying by correction factor, K, given as a function of applied working voltage, E_g, (rms).

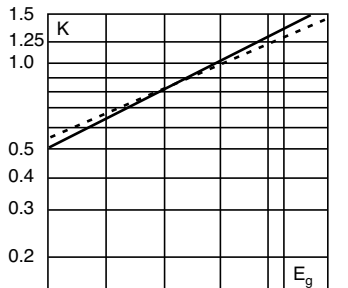

Dashed lines (-----) apply to the following amperages:

Size	Amps.
1*	400A
1	500-630A
2	630-1000A
3	800-1400A

Dimensions (mm)

Type -BKN/-, -GKN/-

Size	Type	A	B	D	E	F	F** (In)	G	H
1*	BKN + GKN/75	74	75	59	45	M8	5/16" - 18 UNC-2B	5	Ø17
1*	BKN/80	80	81	59	45	M8		5	Ø17
1	BKN + GKN/75	74	75	69	53	M8	5/16" - 18 UNC-2B	8	Ø20
1	BKN/80	80	81	69	53	M8		8	Ø20
2	BKN + GKN/75	74	75	77	61	M10	3/8" - 16 UNC-2B	10	Ø24
2	BKN/80	80	81	77	61	M10		10	Ø24
2	BKN + GKN/90	80	91	77	61	M10	3/8" - 16 UNC-2B	10	Ø24
3	BKN + GKN/75	74	76	92	76	M12	1/2" - 13 UNC-2B	10	Ø30
3	BKN/80	81	83	92	76	M12		10	Ø30
3	BKN + GKN/90	81	91	92	76	M12	1/2" - 13 UNC-2B	10	Ø30

**Valid for fuses type -GKN/-.
1mm = 0.0394" / 1" = 25.4mm

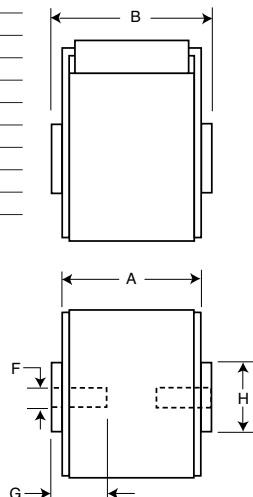
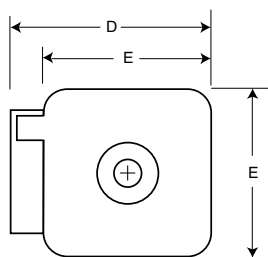

Arc Voltage

This curve gives the peak arc voltage, U_L, which may appear across the fuse during its operation as a function of the applied working voltage, E_g, (rms) at a power factor of 15%.

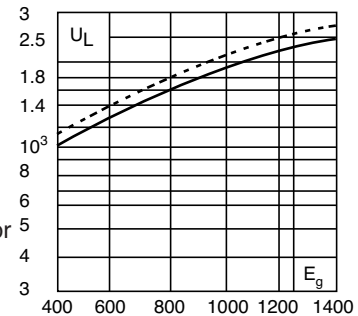

Power Losses

Watts loss at rated current is given in the electrical characteristics. The curve allows the calculation of the power losses at load currents lower than the rated current. The correction factor, K_p, is given as a function of the RMS load current, I_b, in % of the rated current.

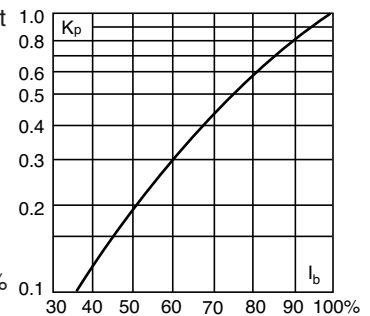

Features and Benefits

- Excellent DC performance
- Low arc voltage and low energy let-through (I²t)
- Low watts loss
- Superior cycling capability

Typical Applications

- DC common bus
- DC drives
- Power converters/rectifiers
- Reduced voltage starters

For Other Voltage Ratings in This Body Style

- See pages 124 (690V/700V) and 148 (1000V)

Square Body Flush End Contact — 1250V/1300V (IEC/UL): 50-1400A

Catalog Numbers

Catalog Numbers					Size	Electrical Characteristics				
-BKN/75 Type K Indicator for Micro	-BKN/80 Type K Indicator for Micro	-BKN/90 Type K Indicator for Micro	-GKN/75 Type K Indicator for Micro	-GKN/90 Type K Indicator for Micro		Rated Current RMS- Amps	I ² t (A ² Sec)			Watts Loss
							Pre-arc	Clearing at 1000V	Clearing at 1250V	
170M3388	170M3438		170M3488		1*	50	135	815	1100	15
170M3389	170M3439		170M3489			63	215	1300	1750	20
170M3390	170M3440		170M3490			80	420	2500	3350	25
170M3391	170M3441		170M3491			100	750	4450	5950	30
170M3392	170M3442		170M3492			125	1450	9000	11500	35
170M3393	170M3443		170M3493			160	2600	16000	21000	40
170M3394	170M3444		170M3494			200	5150	31000	41000	45
170M3395	170M3445		170M3495			250	9200	54500	73000	55
170M3396	170M3446		170M3496			315	18500	115000	150000	60
170M3397	170M3447		170M3497			350	27000	165000	220000	65
	170M3448				400	53000	265000	335000	70	
170M4388	170M4438		170M4488		1	160	1900	11500	15500	45
170M4389	170M4439		170M4489			200	3800	22500	30000	50
170M4390	170M4440		170M4490			250	7750	46000	61500	60
170M4391	170M4441		170M4491			315	15000	90000	120000	65
170M4392	170M4442		170M4492			350	20000	125000	165000	70
170M4393	170M4443		170M4493			400	29500	175000	235000	75
170M4394	170M4444		170M4494			450	42000	250000	335000	80
170M4395†	170M4445		170M4495†			500	69500	340000	435000	85
170M4396‡	170M4446		170M4496‡			550	95000	465000	590000	95
170M4397‡	170M4447†		170M4497‡			630	130000	660000		100
170M5388	170M5438		170M5588		2	250	6500	38500	51500	65
170M5389	170M5439		170M5589			280	9350	55500	74500	70
170M5390	170M5440		170M5590			315	13000	77500	105000	75
170M5391	170M5441		170M5591			350	16500	97500	135000	80
170M5392	170M5442		170M5592			400	23000	140000	180000	85
170M5393	170M5443		170M5593			450	34000	205000	270000	90
170M5394	170M5444	170M5494	170M5594	170M5644		500	48000	285000	380000	95
170M5395	170M5445	170M5495	170M5595	170M5645		550	62000	370000	495000	100
170M5396†	170M5446	170M5496	170M5596†	170M5646		630	115000	575000	730000	110
170M5397‡	170M5447†	170M5497	170M5597‡	170M5647		700	160000	795000	1050000	115
170M5398‡	170M5448‡	170M5498	170M5598‡	170M5648	800	245000	1200000	1550000	120	
		170M5499	170M5599	170M5649	900†	360000	1750000		125	
		170M5500	170M5600	170M5650	1000†	480000	2350000		135	
170M6338	170M6538		170M6588		3	315	9500	58000	77500	85
170M6339	170M6539		170M6589			350	13500	81500	110000	90
170M6340	170M6540		170M6590			400	19500	120000	160000	95
170M6341	170M6541		170M6591			450	31000	185000	245000	100
170M6342	170M6542		170M6592			500	39000	235000	310000	105
170M6343	170M6543		170M6593			550	55000	325000	435000	110
170M6344	170M6544	170M6494	170M6594	170M6644		630	83500	495000	665000	115
170M6345	170M6545	170M6495	170M6595	170M6645		700	115000	705000	940000	120
170M6346†	170M6546	170M6496¥	170M6596†	170M6646¥		800	205000	995000	1300000	125
170M6347‡	170M6547†	170M6497¥	170M6597‡	170M6647¥		900	305000	1500000	1900000	130
170M6348‡	170M6548†	170M6498¥	170M6598‡	170M6648¥	1000	450000	2150000	2750000	135	
170M6349‡	170M6549‡	170M6499¥	170M6599‡	170M6649¥	1100	575000	2800000	3600000	140	
		170M6500	170M6600	170M6650	1250†	810000	3950000		145	
		170M6501	170M6601	170M6651	1400†	1250000	6000000		150	

†Rated voltage (IEC) 1100V.

‡Rated voltage (IEC) 1000V.

¥Rated voltage (IEC) 1250V.

• Watts loss provided at rated current.

• Microswitch indicator ordered separately. See accessories on pages 185-186.

• For fuse curves see pages 166 and 167.

High Speed Fuses

Square Body US Style — 1250V/1300V (IEC/UL): 50-1400A

1250V/1300V (IEC/UL) 50-1400A

Specifications

Description: Square body US style high speed fuses.

Dimensions: See dimensions illustration.

Ratings:

- Volts: — 1250Vac (IEC)
- 1300Vac (UL)

Amps: — 50-1400A

IR: — 100kA RMS Sym.

Agency Information: CE, Designed and tested to IEC 60269: Part 4, UL Recognized. Consult Cooper Bussmann for UL Recognition/CSA Component Acceptance status.

Electrical Characteristics

Total Clearing I²t

The total clearing I²t at rated voltage and at power factor of 15% are given in the electrical characteristics. For other voltages, the clearing I²t is found by multiplying by correction factor, K, given as a function of applied working voltage, E_g, (rms).

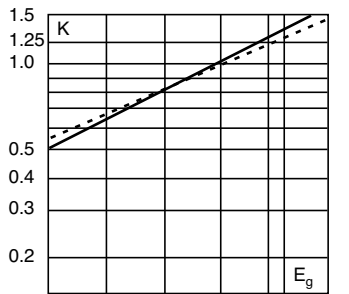

Dashed lines (- - - -) apply to the following amperages:

Size	Amps.
1*	400A
1	500-630A
2	630-1000A
3	800-1400A

Dimensions (mm)

Type -FU/115, -FKE/115

Size	B	C1	C2	D	E	H	I
1*	156	130	101	59	45	20	10
1	160	127	102	69	53	25	14
2	160	127	102	77	61	25	14
3	159	128	101	92	76	36	16

1mm = 0.0394" / 1" = 25.4mm

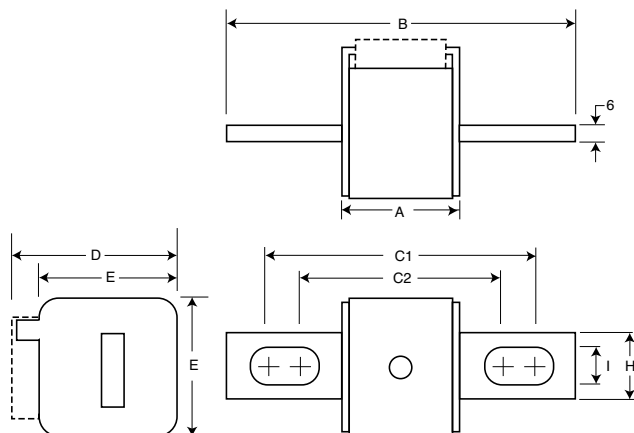

Arc Voltage

This curve gives the peak arc voltage, U_L, which may appear across the fuse during its operation as a function of the applied working voltage, E_g, (rms) at a power factor of 15%.

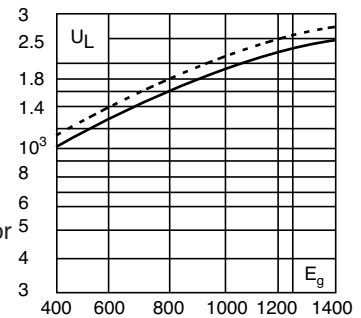

Power Losses

Watts loss at rated current is given in the electrical characteristics. The curve allows the calculation of the power losses at load currents lower than the rated current. The correction factor, K_p, is given as a function of the RMS load current, I_b, in % of the rated current.

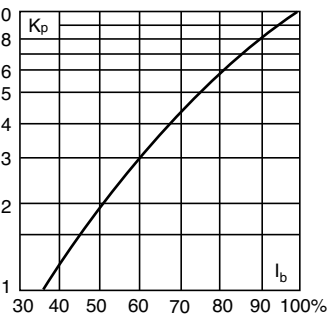

Features and Benefits

- Excellent DC performance
- Low arc voltage and low energy let-through (I²t)
- Low watts loss
- Superior cycling capability

Typical Applications

- DC common bus
- DC drives
- Power converters/rectifiers
- Reduced voltage starters

For Other Voltage Ratings in This Body Style

- See pages 126 (690V/700V) and 150 (1000V)

Square Body US Style — 1250V/1300V (IEC/UL): 50-1400A

Catalog Numbers

Catalog Numbers		Size	Electrical Characteristics				
-FU/115 Without Indicator	-FKE/115 Type K Indicator for Micro		Rated Current RMS-Amps	I ² t (A ² Sec)			Watts Loss
				Pre-arc	Clearing at 1000V	Clearing at 1250V	
170M3688	170M3738	1*	50	135	815	1100	15
170M3689	170M3739		63	215	1300	1750	20
170M3690	170M3740		80	420	2500	3350	25
170M3691	170M3741		100	750	4450	5950	30
170M3692	170M3742		125	1450	9000	11500	35
170M3693	170M3743		160	2600	16000	21000	40
170M3694	170M3744		200	5150	31000	41000	45
170M3695	170M3745		250	9200	54500	73000	55
170M3696	170M3746		315	18500	115000	150000	60
170M3697	170M3747		350	27000	165000	220000	65
170M4688	170M4738	1	160	1900	11500	15500	45
170M4689	170M4739		200	3800	22500	30000	50
170M4690	170M4740		250	7750	46000	61500	60
170M4691	170M4741		315	15000	90000	120000	65
170M4692	170M4742		350	20000	125000	165000	70
170M4693	170M4743		400	29500	175000	235000	75
170M4694	170M4744		450	42000	250000	335000	80
170M4695	170M4745		500†	69500	340000		85
170M4696	170M4746		550‡	95000	465000		95
170M4697	170M4747		630‡	130000	660000		100
170M5688	170M5738	2	250	6500	38500	51500	65
170M5689	170M5739		280	9350	55500	74500	70
170M5690	170M5740		315	13000	77500	105000	75
170M5691	170M5741		350	16500	97500	135000	80
170M5692	170M5742		400	23000	140000	180000	85
170M5693	170M5743		450	34000	205000	270000	90
170M5694	170M5744		500	48000	285000	380000	95
170M5695	170M5745		550	62000	370000	495000	100
170M5696	170M5746		630	115000	575000	730000	110
170M5697	170M5747		700†	160000	795000		115
170M5698	170M5748	800‡	245000	1200000		120	
170M5699	170M5749	900‡	360000	1750000		125	
170M5700	170M5750	1000‡	480000	2350000		135	
170M6688	170M6738	3	315	9500	58000	77500	185
170M6689	170M6739		350	13500	81500	110000	90
170M6690	170M6740		400	19500	120000	160000	95
170M6691	170M6741		450	31000	185000	245000	100
170M6692	170M6742		500	39000	235000	310000	105
170M6693	170M6743		550	55000	325000	435000	110
170M6694	170M6744		630	83500	495000	665000	115
170M6695	170M6745		700	115000	705000	940000	120
170M6696	170M6746		800	205000	995000	1300000	125
170M6697	170M6747		900	305000	1500000	1900000	130
170M6698†	170M6748†	1000¥	450000	2150000		135	
170M6699†	170M6749†	1100¥	575000	2800000		140	
170M6700‡	170M6750‡	1250¥	810000	3950000		145	
170M6701‡	170M6751‡	1400¥	1250000	6000000		150	

†Rated voltage (IEC) 1100.

‡Rated voltage (IEC) 1000V.

¥ UL Recognition at 1000V.

• Watts loss provided at rated current.

• Microswitch indicator ordered separately. See accessories on pages 185-186.

• For fuse curves see pages 166 and 167.

High Speed
Fuses

Square Body Size 1*, 1 — 1250V/1300V (IEC/UL): 50-1400A

Size 1* — 50-400A:1250V
Time-Current Curve

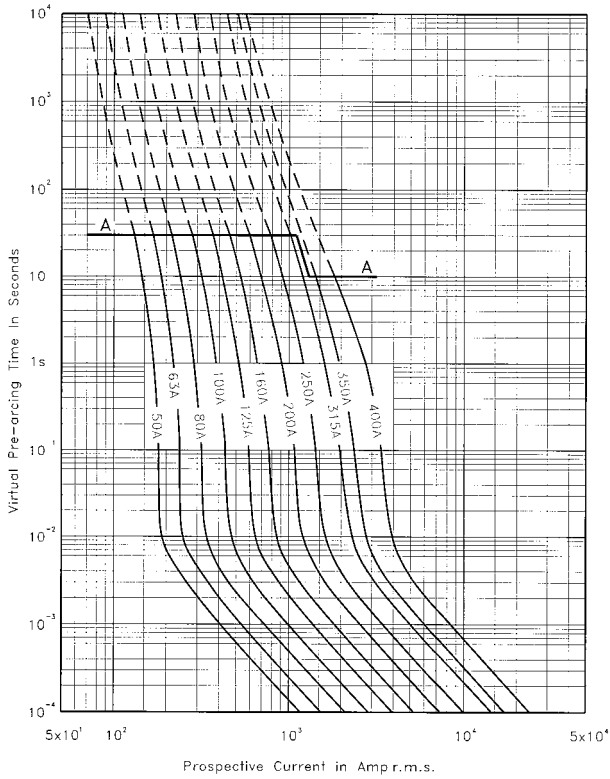

Size 1 — 160-630A: 1250V
Time-Current Curve

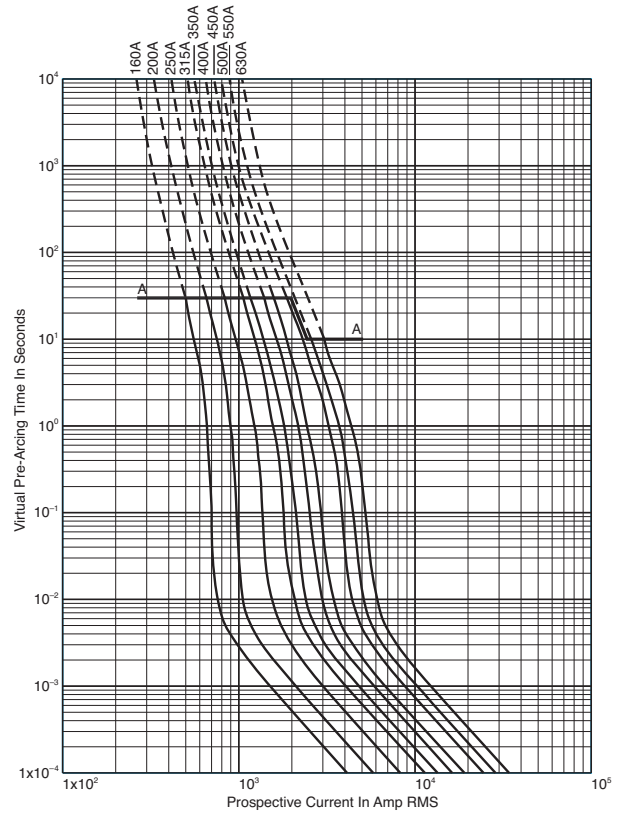

Peak Let-Through Curve

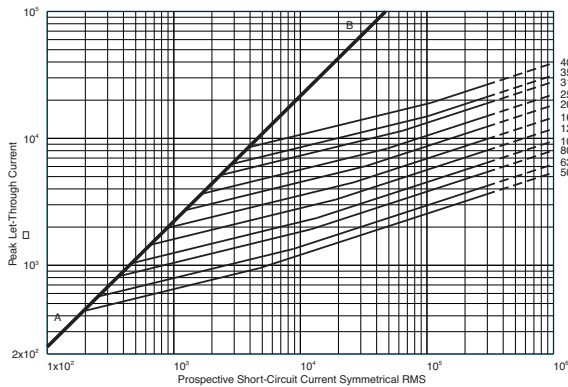

Peak Let-Through Curve

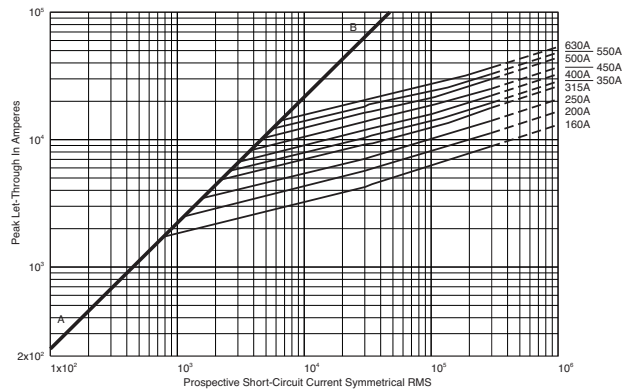

630A fuse is derated to 1100V (IEC).

Square Body Size 2, 3 — 1250V/1300V (IEC/UL): 50-1400A

Size 2 — 250-1000A: 1250V
Time-Current Curve

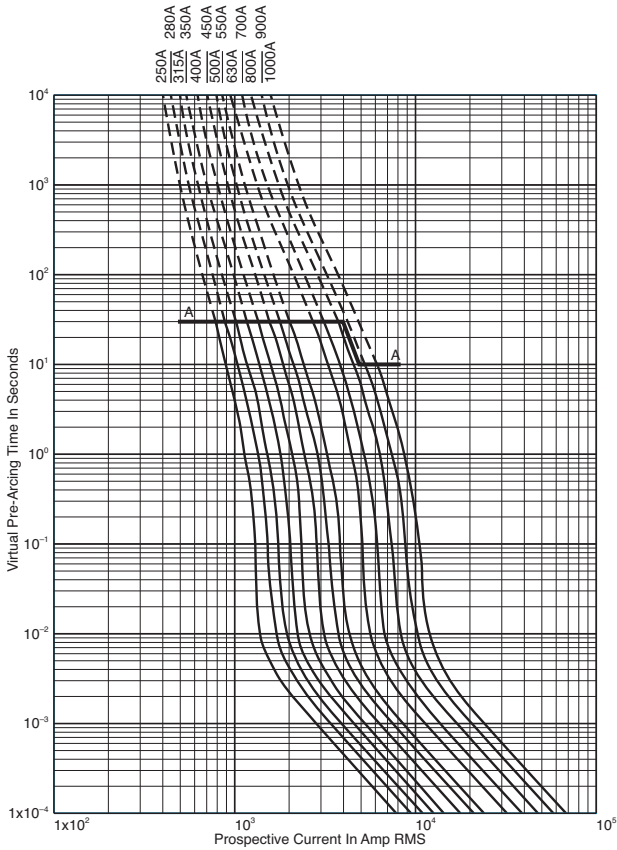

Size 3 — 315-1400A: 1250V
Time-Current Curve

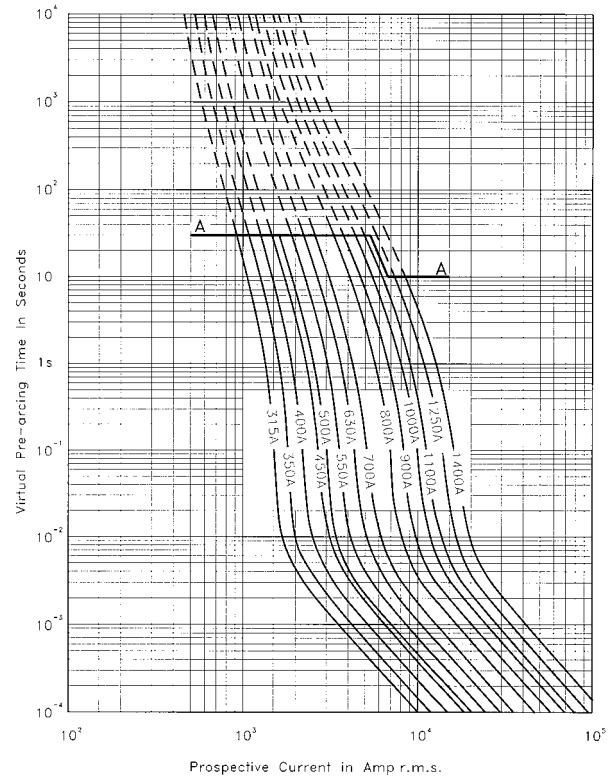

High Speed Fuses

Peak Let-Through Curve

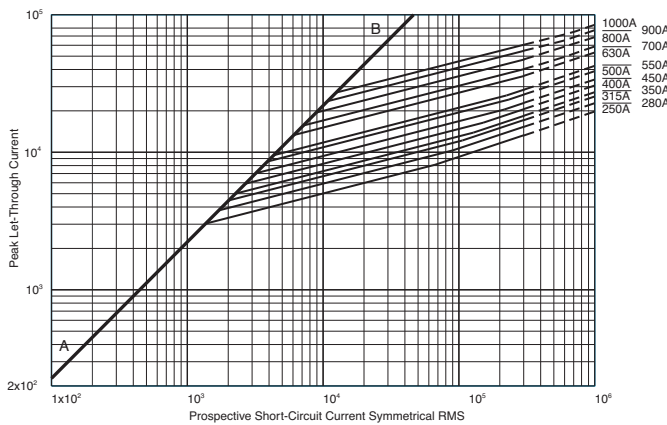

900-1000A fuses are derated to 1100V (IEC).

Peak Let-Through Curve

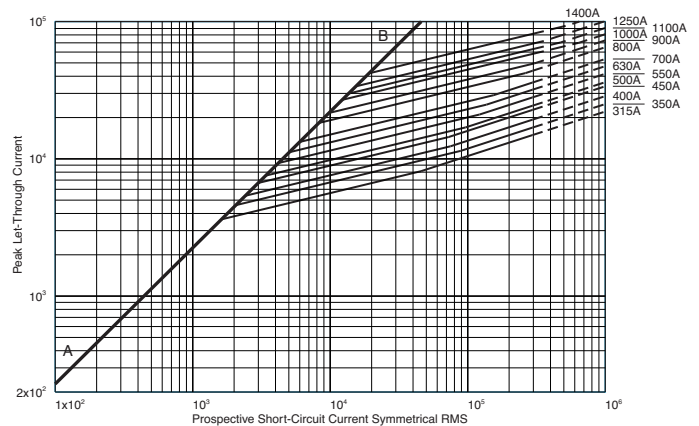

1250-1400A fuses are derated to 1100V (IEC).

Square Body Flush End Contact Size 4 — 1250V (IEC): 1400-2500A

1250V (IEC) 1400-2500A

Specifications

Description: High speed square body fuses, for the protection of the power rectifier section of the equipment.

Dimensions: See dimensions illustration.

Ratings:

Volts: — 1250Vac (IEC)

Amps: — 1400-2500A

IR: — 125kA RMS Sym.

Agency Information: CE, Designed and tested to IEC 60269: Part 4, UL Recognized.

Electrical Characteristics

Total clearing I^2t

The total clearing I^2t at rated voltage and at power factor of 15% are given in the electrical characteristics. For other voltages, the clearing I^2t is found by multiplying by correction factor, K, given as a function of applied working voltage, E_g , (rms).

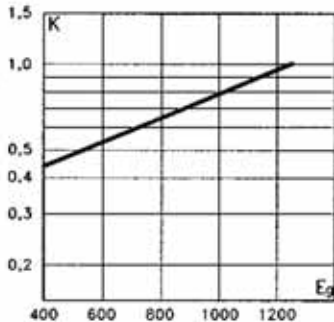

Arc Voltage

This curve gives the peak arc voltage, U_L , which may appear across the fuse during its operation as a function of the applied working voltage E_g , (rms) at a power factor of 15%.

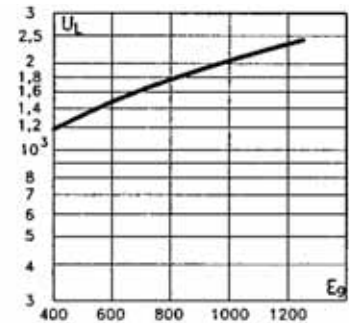

Power Losses

Watts loss at rated current is given in the electrical characteristics. The curve allows the calculation of the power losses at load currents lower than the rated current. The correction factor, K_p , is given as a function of the RMS load current, I_b , in % of the rated current.

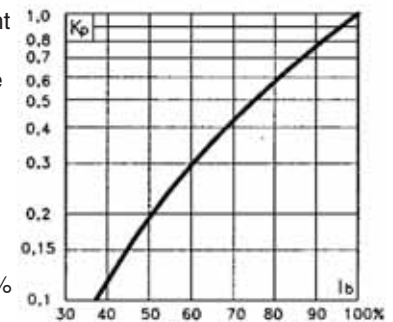

Features and Benefits

- Excellent DC performance
- Low arc voltage and low energy let-through (I^2t)
- Low watts loss
- Superior cycling capability

Typical Applications

- DC common bus
- DC drives
- Power converters/rectifiers
- Reduced voltage starters

For Other Voltage Ratings in This Body Style

- See pages 135 (690V/700V) and 154 (1000V)

Catalog Numbers

Fuse Size	Catalog Number		Electrical Characteristics				
	-BKN/105 Type K Indicator	-SBKN/105 Type K Indicator	Rated Voltage (V)	Rated Current RMS-Amp	I^2t (A ² Sec)		Watt Loss (W)
					Pre-arc	Clearing at 1250V	
4	170M7217	170M7512	1250	1400	800000	5000000	195
	170M7597	170M7510		1500	1000000	6200000	200
	170M7676	170M7511		1700	1400000	8700000	220
	170M7532	170M7976		1800	1700000	11000000	225
	170M7633	170M7513		2000	2300000	14500000	235
	170M7592	170M7546		2200	3100000	19500000	245
	170M7107	170M7516		2400	4000000	25000000	255
	170M7595	170M7978		2500	4500000	28000000	260

Data Sheet: 170K6640 , 170K6642

Square Body Flush End Contact Size 4 — 1250V (IEC): 1400-2500A

Flush End Contact - Size 4 1250V (IEC) / 1400 – 2500A

Dimensions (mm):

Type 4BKN/105

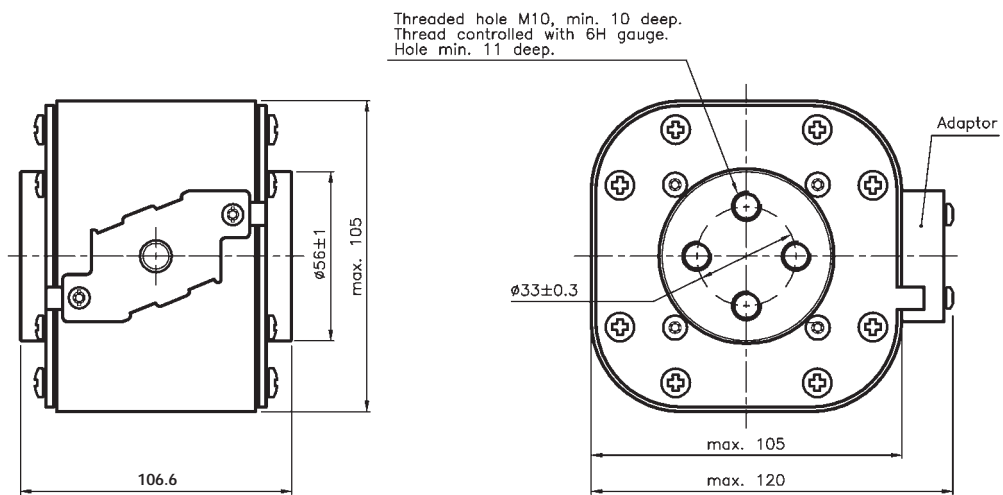

Type 4SBKN/105

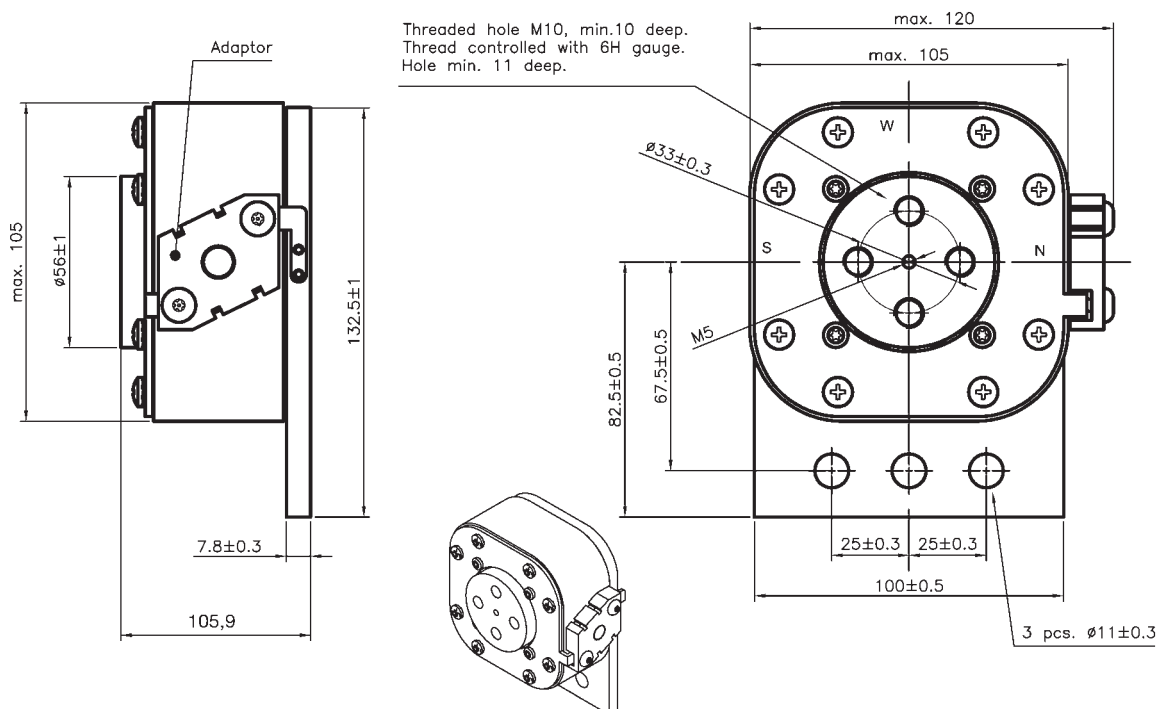

Square Body Flush End Contact Size 4 — 1250V (IEC): 1400-2500A

Size 4 — 1400-2400A: 1250V
Time-Current Curve

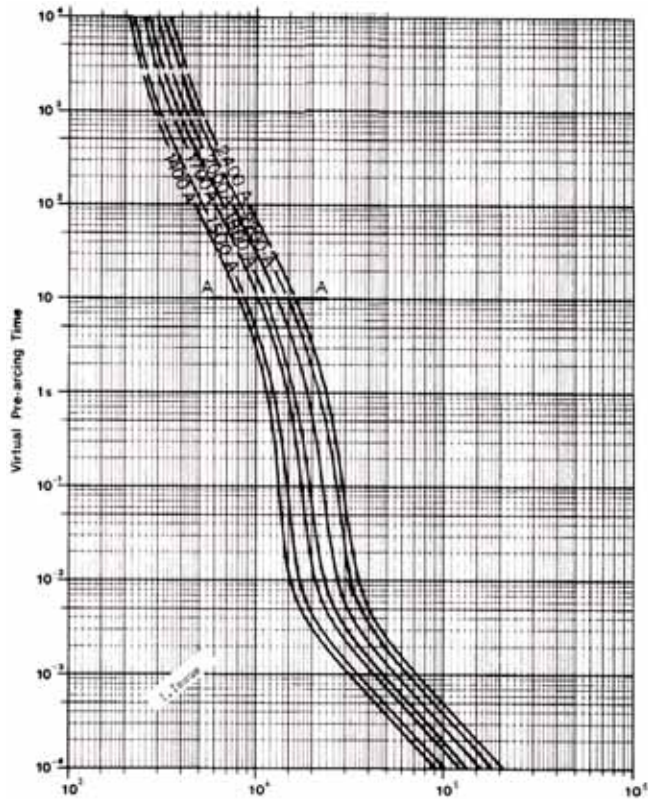

Prospective Current in Amps RMS

Size 4 — 2300-2500A: 1250V
Time-Current Curve

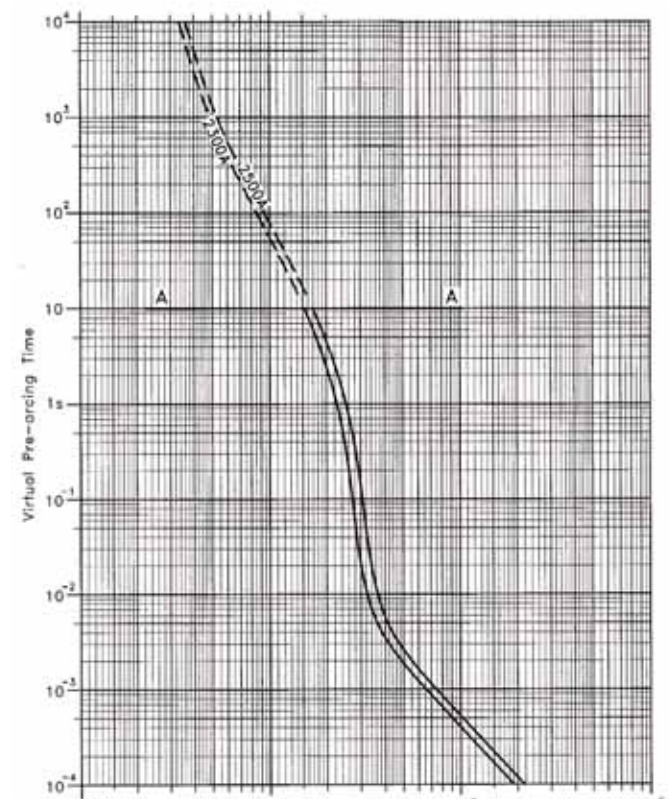

Prospective Current in Amps RMS

Peak Let-Through Curve

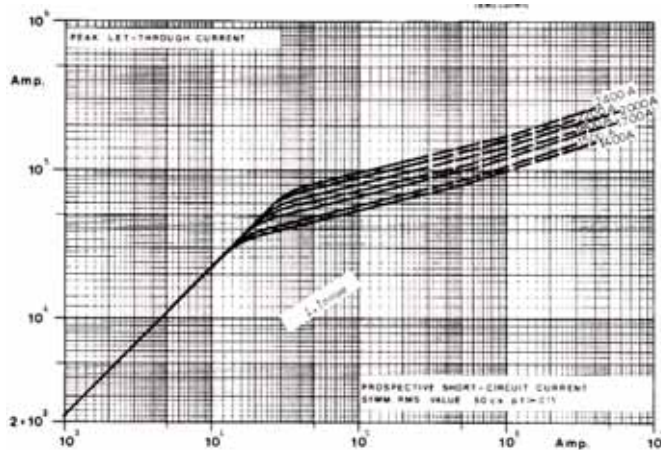

Data Sheet: Available upon request

Peak Let-Through Curve

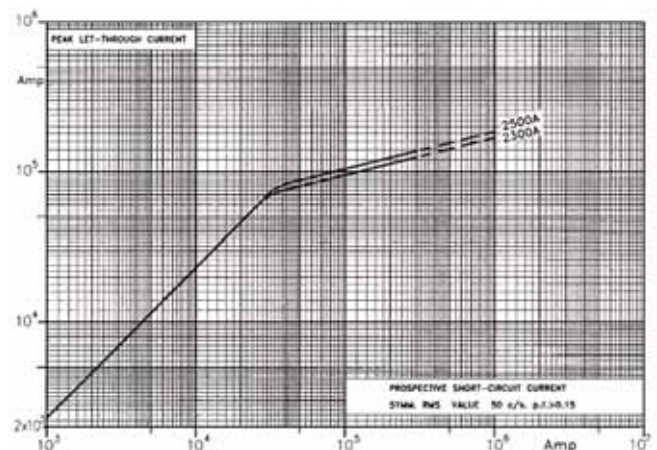

Data Sheet: Available upon request

Square Body Flush End Contact Size 23— 1250V (IEC/UL): 630-2800A

1250V (IEC) 630-2800A

Specifications

Description: High speed square body fuses, for the protection of the power rectifier section of the equipment.

Dimensions: See dimensions illustration.

Ratings:

Volts: — 1250Vac (IEC)

Amps: — 630-2800A

IR: — 125kA RMS Sym.

Agency Information: CE, Designed and tested to IEC 60269: Part 4, UL Recognized.

Electrical

Characteristics

Total clearing I^2t

The total clearing I^2t at rated voltage and at power factor of 15% are given in the electrical characteristics. For other voltages, the clearing I^2t is found by multiplying by correction factor, K, given as a function of applied working voltage, E_g , (rms).

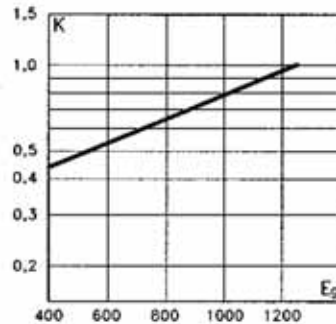

Arc Voltage

This curve gives the peak arc voltage, U_L , which may appear across the fuse during its operation as a function of the applied working voltage E_g , (rms) at a power factor of 15%.

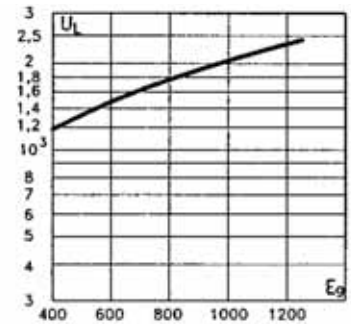

Power Losses

Watts loss at rated current is given in the electrical characteristics. The curve allows the calculation of the power losses at load currents lower than the rated current. The correction factor, K_p , is given as a function of the RMS load current, I_b , in % of the rated current.

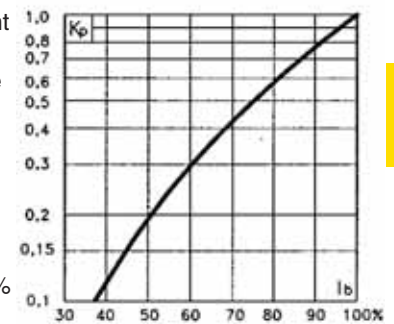

Features and Benefits

- Excellent DC performance
- Low arc voltage and low energy let-through (I^2t)
- Low watts loss
- Superior cycling capability

Typical Applications

- DC common bus
- DC drives
- Power converters/rectifiers
- Reduced voltage starters

For Other Voltage Ratings in This Body Style

- See pages 137 (660V) and 157 (1000V)

Catalog Numbers

Fuse Size	Catalog Number						Electrical Characteristics				
	-BU/75 without Indicator	-BKE/75 Type K Indicator	-BKN/75 Type K Indicator	-BU/80 without Indicator	-BKE/80 Type K Indicator	-BKN/80 Type K Indicator	Rated Voltage (V)	Rated Current RMS-Amp	I^2t (A ² Sec)		Watts Loss (W)
									Pre-arc	Clearing at 1250V	
23	170M6775	170M6795	170M6785				1250	630	38000	310000	170
	170M6776	170M6796	170M6786					700	54000	440000	180
	170M6777	170M6797	170M6787					800	78000	640000	190
	170M6805	170M6807	170M6806					900	120000	980000	200
	170M6778	170M6798	170M6788					1000	155000	1250000	210
	170M6779	170M6799	170M6789					1100	220000	1750000	220
	170M6780	170M6800	170M6790					1250	330000	2700000	230
	170M6781	170M6801	170M6791					1400	460000	3800000	240
	170M6782	170M6802	170M6792					1600	820000	5200000	250
	170M6783	170M6803	170M6793					1800	1200000	7600000	260
				170M6784	170M6804	170M6794	2000	1800000	11000000	270	
				170M6815	170M6833	170M6827	2200	2300000	14500000	280	
				170M6816	170M6834	170M6828	1100	2500	3200000	†16000000	290
				170M6817	170M6835	170M6829		2800	5000000	†24000000	300

† A²s @ 1000V
Data Sheet: 170K6638

Square Body Flush End Contact Size 23— 1250V (IEC/UL): 630-2800A

Flush End Contact - Size 23
1250V (IEC) / 1000 - 4000A

Dimensions (mm):

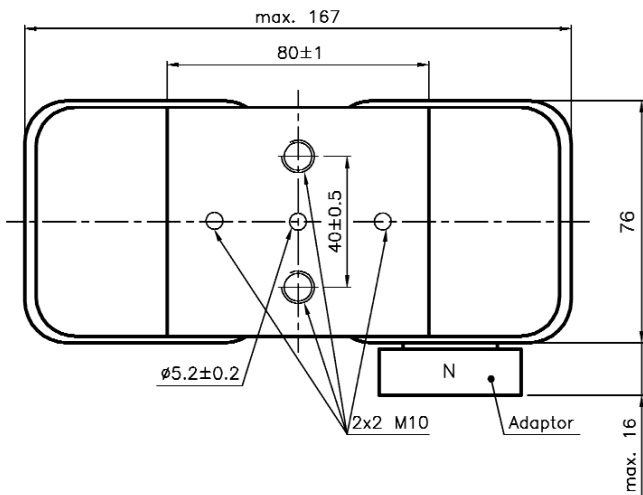
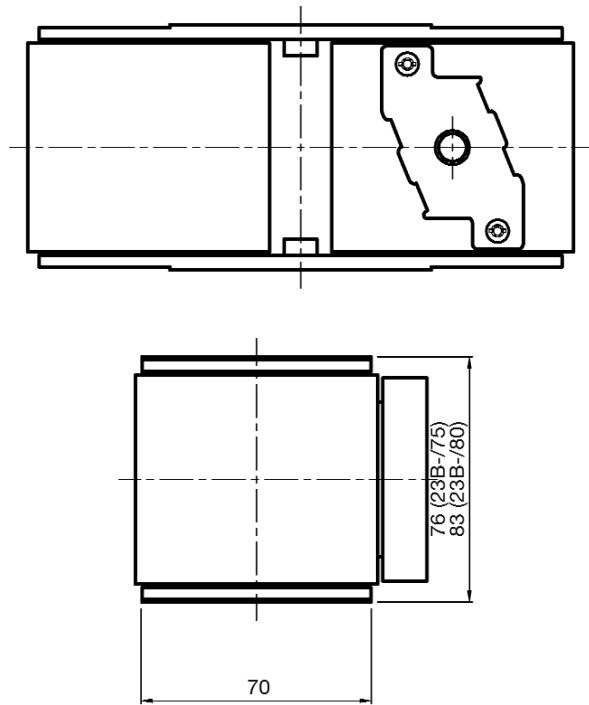

Size 23 — 630-2800A: 1250V
Time-Current Curve

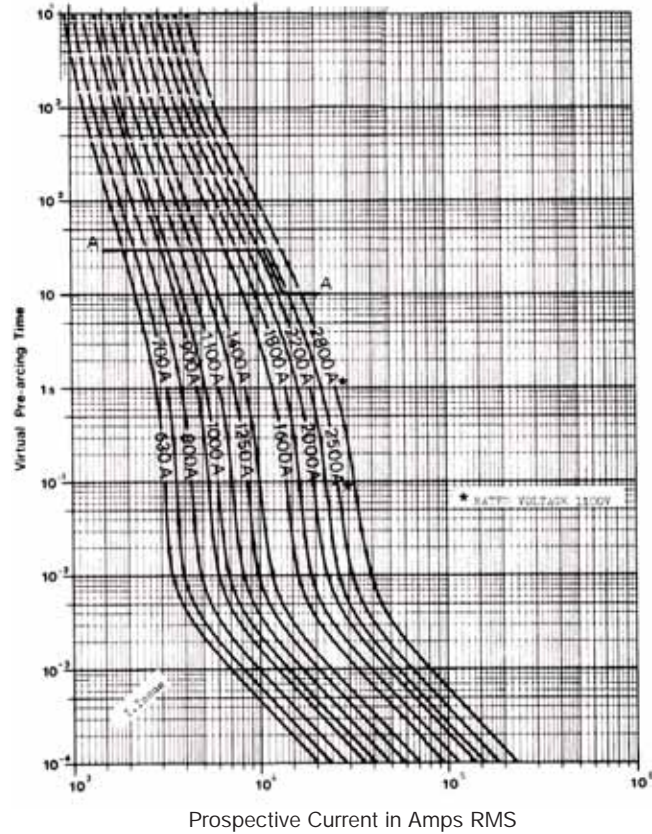

Peak Let-Through Curve

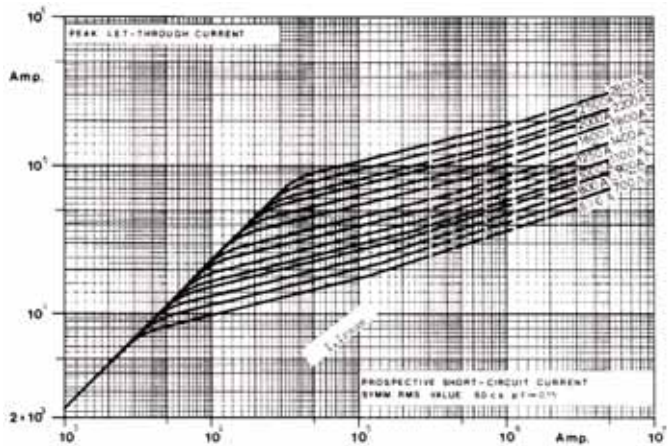

Square Body Flush End Contact Size 5— 1000V-2000V: 1800-5000A

1000V (IEC) 1800-5000A

Specifications

Description: High speed square body fuses, for the protection or isolation for components such as diodes, silicon controlled rectifiers (SCRs), Gate turn-Off Thyristors (GTOs) and IGBTs.

Dimensions: See dimensions illustration.

Ratings:

Volts: — 1000-2000Vac (IEC)

Amps: — 1800-5000A

IR: — 300kA RMS Sym. estimated, 197kA tested

Agency Information: Consult Cooper Bussmann.
bulehighspeedtechnical@cooperindustries.com

Features and Benefits

- Excellent DC performance
- Low arc voltage and low energy let-through (I^2t)
- Low watts loss
- Superior cycling capability

Typical Applications

- AC and DC drives
- High power converters/rectifiers

Dimensions - mm (in)



This dimension drawing is an example of the range of size 5 fuses available.

Contact Cooper Bussmann for available parts and technical information.

Square Body DC Fuses — 750Vdc: 63-500A

750Vdc 63-500A

Specifications

Description: High speed fuses, for the protection of DC circuits in equipment.

Dimensions: See dimensions illustration.

Ratings:

Volts: — 750Vdc

Amps: — 63-500A

IR: — 750Vdc IR: 100kA, L/R = 100 ms.

— 1000Vdc IR: 100kA, L/R = 40 ms

Agency Information: Consult Cooper Bussmann.

Electrical Characteristics

Arc Voltage

This curve gives the peak arc voltage, U_L , which may appear across the fuse during its operation as a function of the applied working voltage E_g .

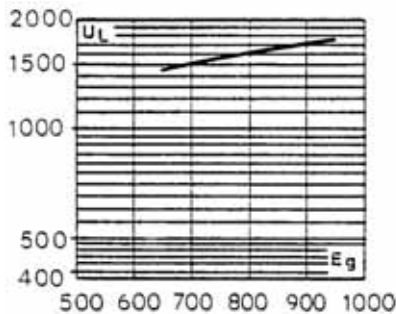

Power Losses

Watts loss at rated current is given in the electrical characteristics. The curve allows the calculation of the power losses at load currents lower than the rated current. The correction factor, K_p , is given as a function of the RMS load current, I_b , in % of the rated current.

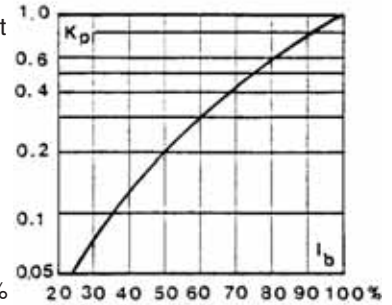

Features and Benefits

- Excellent DC performance
- Low arc voltage and low energy let-through (I^2t)
- Low watts loss
- Superior cycling capability

Typical Applications

- DC common bus
- DC drives
- Power converters/rectifiers
- Reduced voltage starters

Catalog Numbers

Fuse Size	Catalog Numbers		Electrical Characteristics		
	-BK/130	-EK/-	Rated Voltage (Vdc)	Rated Current RMS-Amp	Watt Loss (W)
1*	170E3577	170E3583	750	63	10.0
	170E3578	170E3584		80	13.0
	170E3579	170E3585		100	16.0
	170E3580	170E3586		125	21.0
	170E3581	170E3587		160	26.0
1	170E5417	170E5420		200	37.0
	170E5418	170E5421		250	46.0
2	170E8335	170E8345		250	47.0
	170E8336	170E8346		315	57.0
	170E8337	170E8347		400	73.0
3	170E9681	170E9685		500	91.0

Data Sheet: Size 1*: 170K3620
 Size 1: 170K3622
 Size 2: 170K3624
 Size 3: 170K3626
 Microswitch: 170H0069, 170H3027 (gold)

Square Body DC Fuses — 750Vdc: 63-500A

Square Body DC Fuses 750Vdc / 63 - 500A

(mm):

Type -BK/130

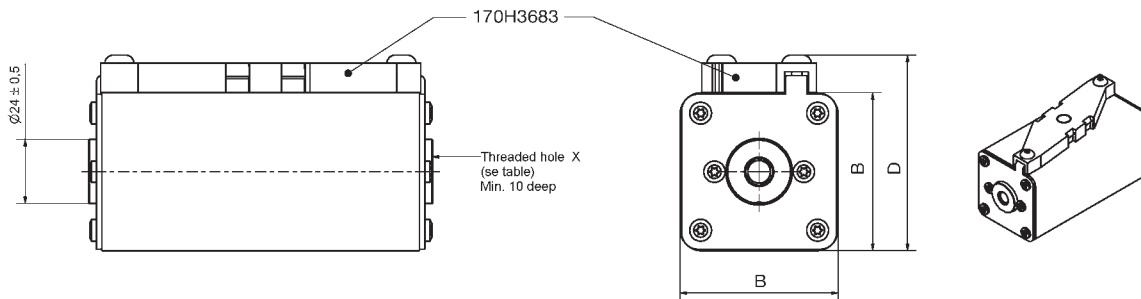

Size/Type	A	B	D
1* BK/130	129	43	61
1 BK/130	130	51	69
2 BK/130	130	59	77
3 BK/130	131	74	90

Type -EK/-

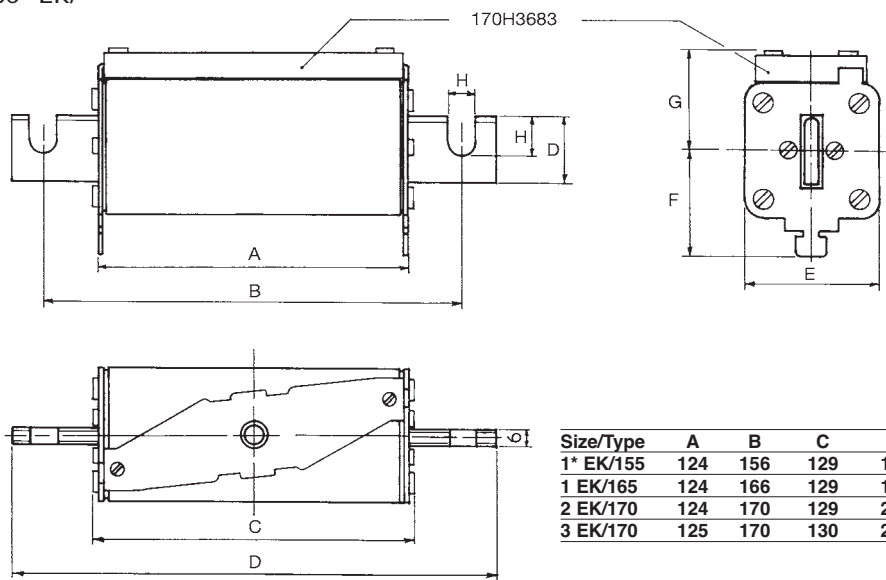

Size/Type	A	B	C	D	E	F	G	H	I	J
1* EK/155	124	156	129	180	43	36	41	9	9	18
1 EK/165	124	166	129	191	51	37	41	11	14	25
2 EK/170	124	170	129	205	59	42	48	13	21	30
3 EK/170	125	170	130	206	74	51	56	13	20	36

High Speed Fuses

Square Body DC Fuses — 750Vdc: 63-500A

Square Body DC Fuse — 63-160A: 750V
Time-Current Curve

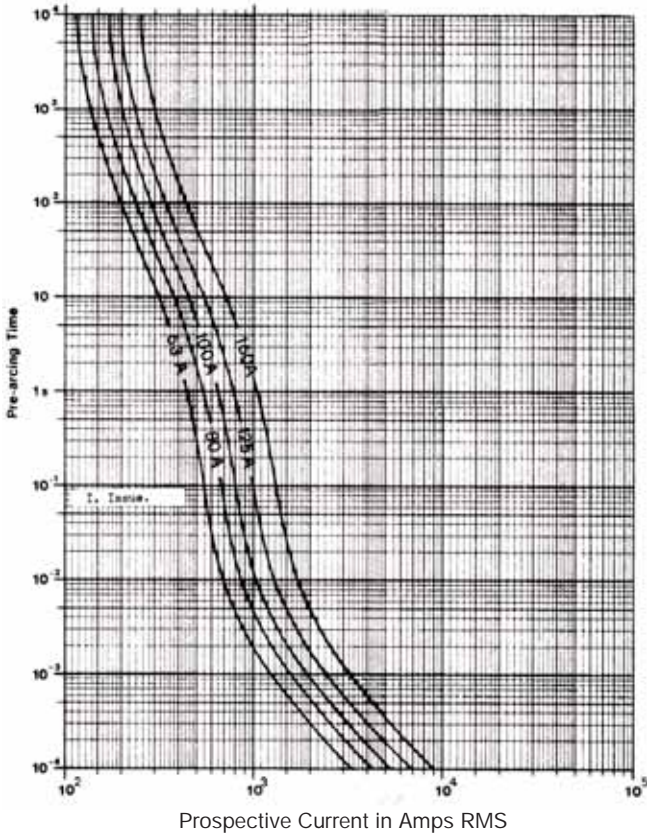

Square Body DC Fuse — 200-250A: 750V
Time-Current Curve

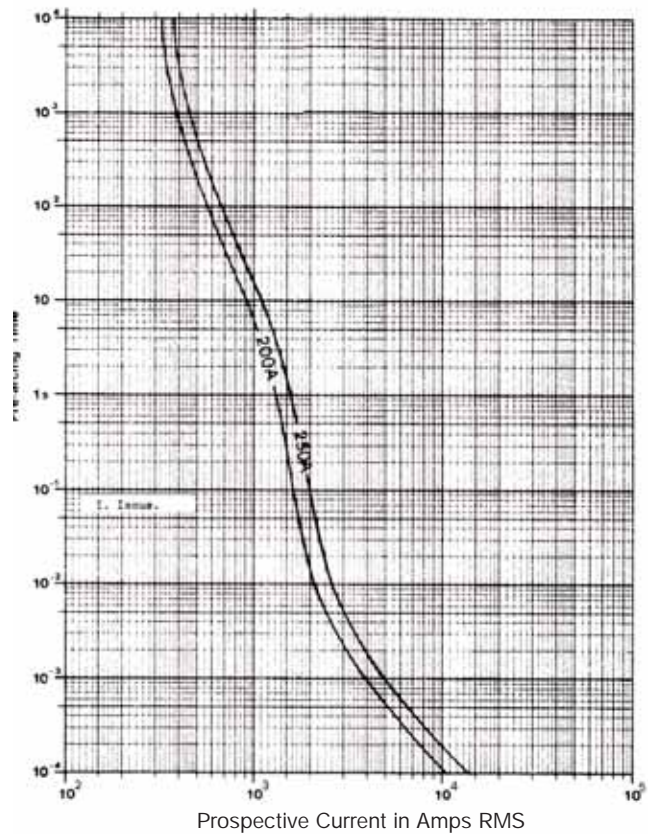

Peak Let-Through Curve

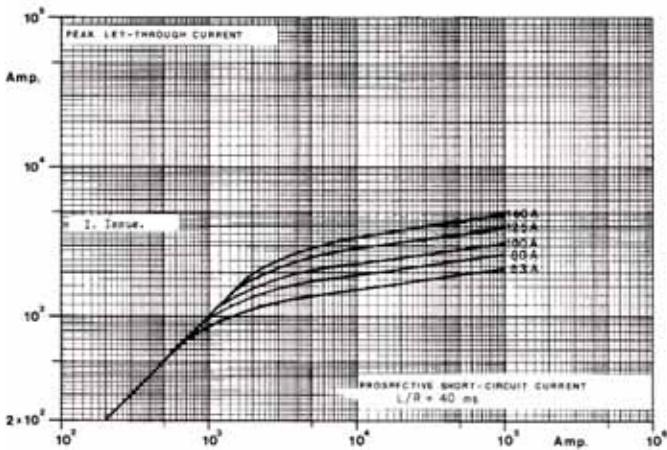

Peak Let-Through Curve

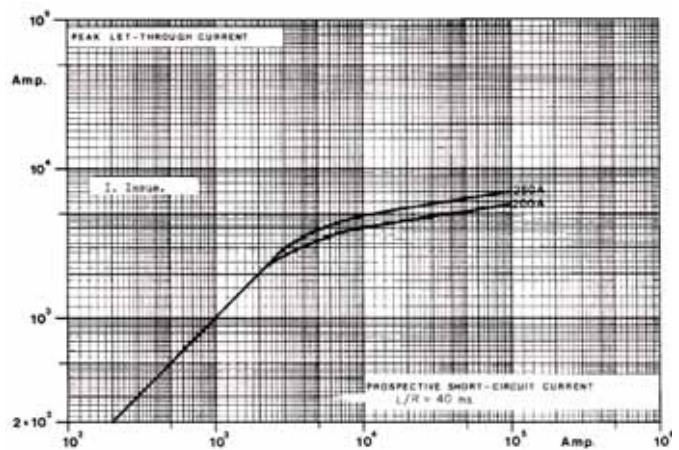

Data Sheet: Available upon request

Data Sheet: Available upon request

Square Body DC Fuses — 750Vdc: 63-500A

Square Body DC Fuse — 250-400A: 750V
Time-Current Curve

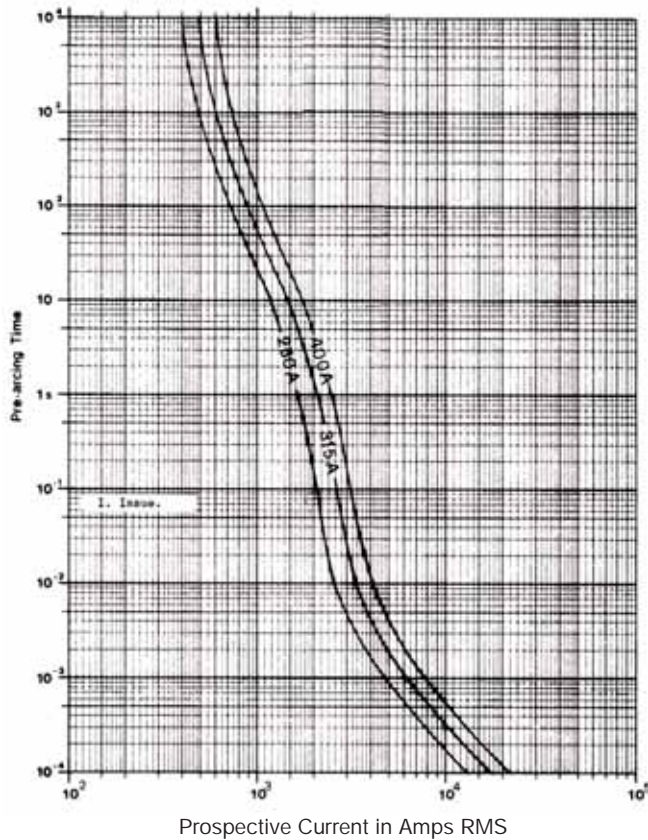

Square Body DC Fuse — 500A: 750V
Time-Current Curve

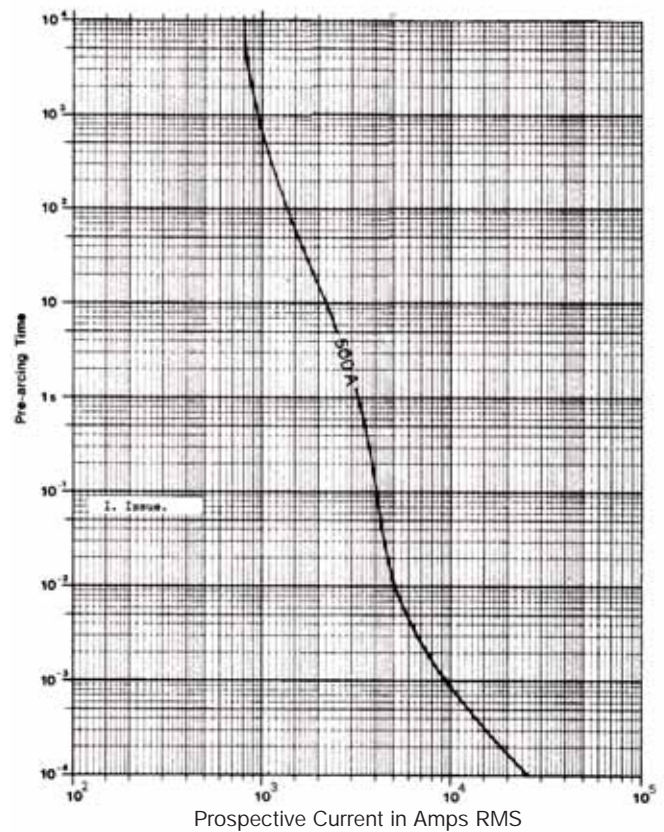

High Speed Fuses

Peak Let-Through Curve

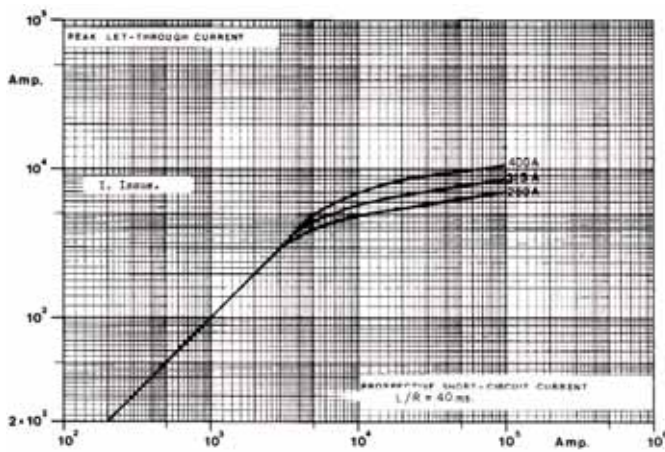

Peak Let-Through Curve

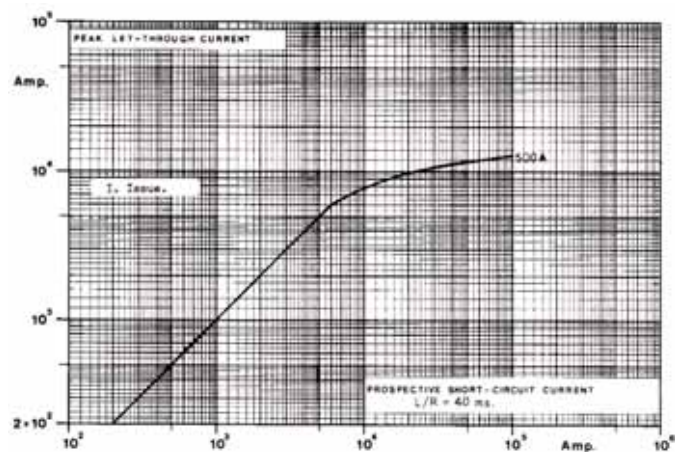

Data Sheet: Available upon request

Data Sheet: Available upon request

Square Body DC Fuses — 1200Vdc: 160-420A

1200Vdc 160-420A

Specifications

Description: High speed fuses that provides superior protection in light and heavy harsh DC traction applications as 1200Vdc and below circuits, and as DC link/power converters.

Dimensions: See dimensions illustration.

Ratings:

Volts: — 1200Vdc

Amps: — 160-420A

IR: — 1200Vdc = 100kA L/R: 15 ms.

Agency Information: Consult Cooper Bussmann.

Electrical Characteristics

Arc Voltage

This curve gives the peak arc voltage, U_L , which may appear across the fuse during its operation as a function of the applied working voltage E_g .

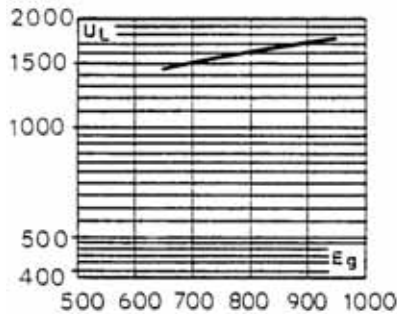

Power Losses

Watts loss at rated current is given in the electrical characteristics. The curve allows the calculation of the power losses at load currents lower than the rated current. The correction factor, K_p , is given as a function of the RMS load current, I_b , in % of the rated current.

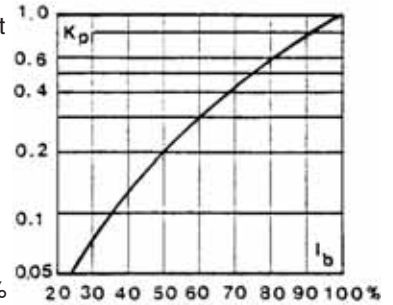

Features and Benefits

- Excellent DC performance
- Low arc voltage and low energy let-through (I^2t)
- Low watts loss
- Superior cycling capability

Typical Applications

- DC common bus
- DC drives
- Power converters/rectifiers
- Reduced voltage starters

Catalog Numbers

Fuse Type	Cat. Numbers -SKNB/140 Type K Indicator	Rated Voltage (Vdc)	Rated Current RMS-Amp	Electrical Characteristics		Watts Loss (W)
				Max I^2t (A ² Sec) @ 1000Vdc		
				L/R = 15ms	L/R = 45ms	
2SKN / 140	170F8230	1200	160	12000	20000	75.0
	170F8231		200	20000	35000	85.0
	170F8232		250	43000	75000	94.0
	170F8233		315	87000	150000	104.0
	170F8234		400	180000	310000	120.0
	170F8235		420	215000	375000	122.0

Data Sheet: 170K5520

Microswitch: 170H0069, 170H3027 (gold)

Dimensions (mm):

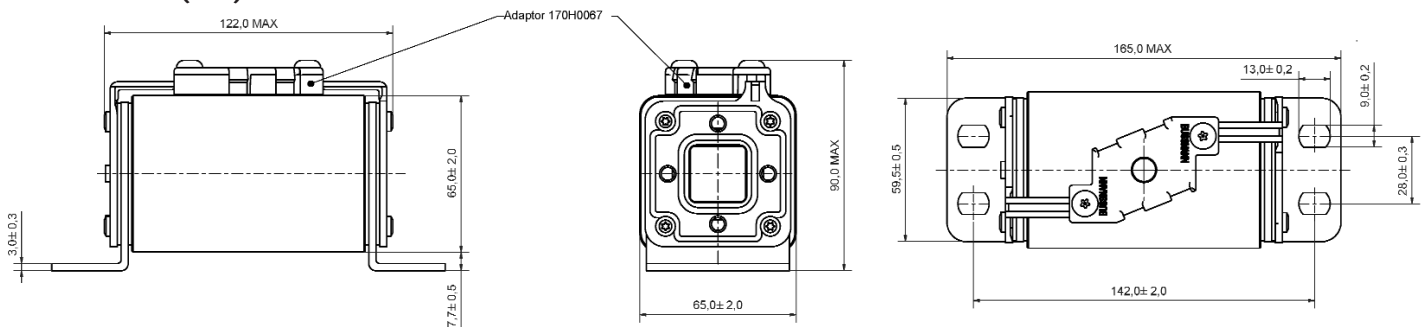

Square Body DC Fuses — 1200Vdc: 160-420A

Square Body DC Fuse — 160-420A: 1200V Time-Current Curve

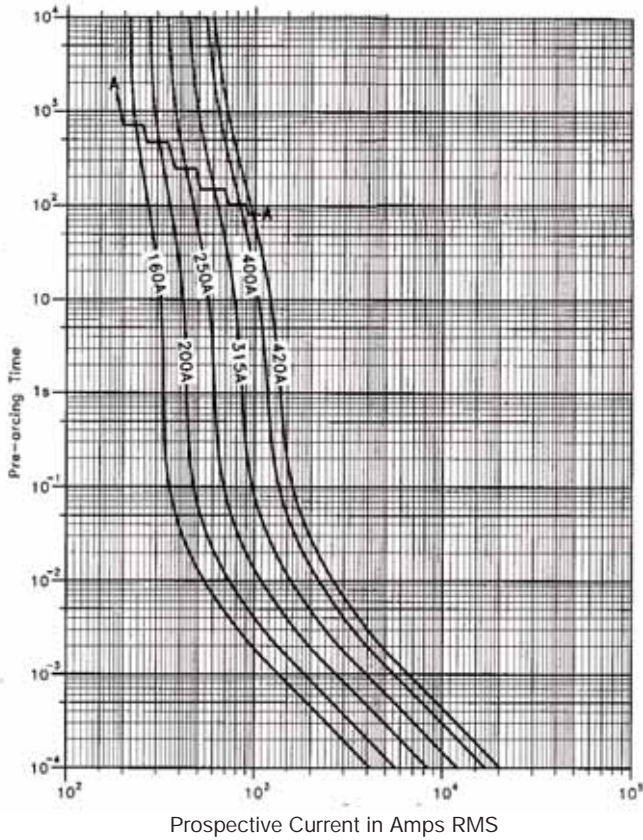

High Speed
Fuses

Data Sheet: Available upon request

Square Body DC fuses — 2000Vdc: 10-125A

2000Vdc 10-125A

Specifications

Description: High speed fuses for the protection of DC circuits in equipment.

Dimensions: See dimensions illustration.

Ratings:

Volts: — 1200Vdc

Amps: — 160-420A

IR: — 1200Vdc = 100kA L/R: 15 ms.

Agency Information: Consult Cooper Bussmann.

Electrical Characteristics

Arc Voltage

This curve gives the peak arc voltage, U_L , which may appear across the fuse during its operation as a function of the applied working voltage E_g .

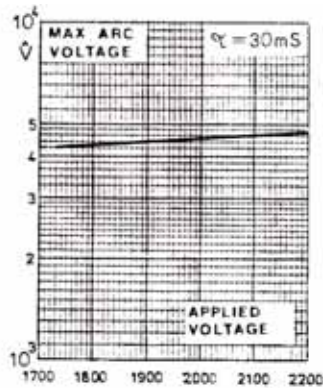

Power Losses

Watts loss at rated current is given in the electrical characteristics. The curve allows the calculation of the power losses at load currents lower than the rated current. The correction factor, K_p , is given as a function of the RMS load current, I_b , in % of the rated current.

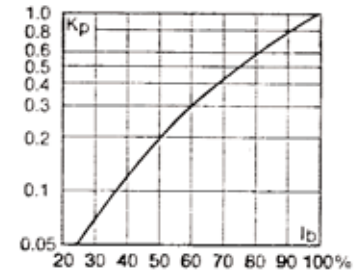

Features and Benefits

- Excellent DC performance
- Low arc voltage and low energy let-through (I^2t)
- Low watts loss
- Superior cycling capability

Typical Applications

- DC common bus
- DC drives
- Power converters/rectifiers
- Reduced voltage starters

Catalog Numbers

Fuse Type	Cat. Number	Electrical Characteristics		
	-SKN/246 Type K Indicator	Rated Voltage (Vdc)	Rated Current RMS-Amp	Watt Loss (W)
1*SKN/246	170E3976	2000	10	7
	170E3970		16	11
	170E3950		20	13
	170E3951		25	17
	170E3952		32	22
	170E3953		40	27
	170E3954		50	34
	170E3955		63	43
	170E3956		80	50

Fuse Type	Cat. Number	Electrical Characteristics		
	-SKN/246 Type K Indicator	Rated Voltage (Vdc)	Rated Current RMS-Amp	Watt Loss (W)
1*SKN/246	170E3937	2000	20	13
	170E3938		25	16
	170E3939		32	20
	170E3940		40	25
	170E3941		50	32
	170E3942		63	40
	170E3943		80	51
	170E3944		100	64
	170E3945		125	80

2000Vdc / 10 - 125A

Dimensions (mm):

Data Sheet: 170K4538
Microswitch: 170H0239, 170H3030 (gold)

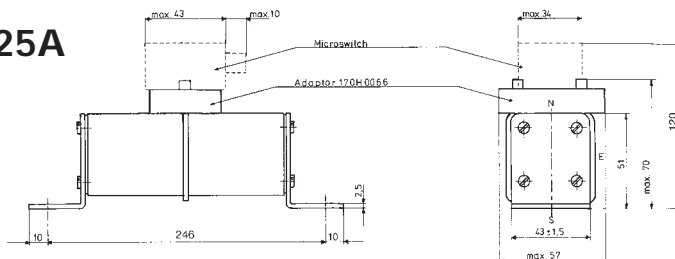

Data Sheet: 170K4900
Microswitch: 170H0239, 170H3030 (gold)

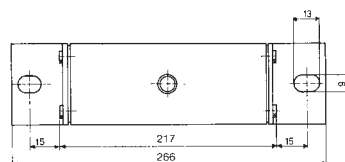

Square Body DC fuses — 2000Vdc: 10-125A

Square Body DC Fuses — 10-80A: 2000V
Time-Current Curve

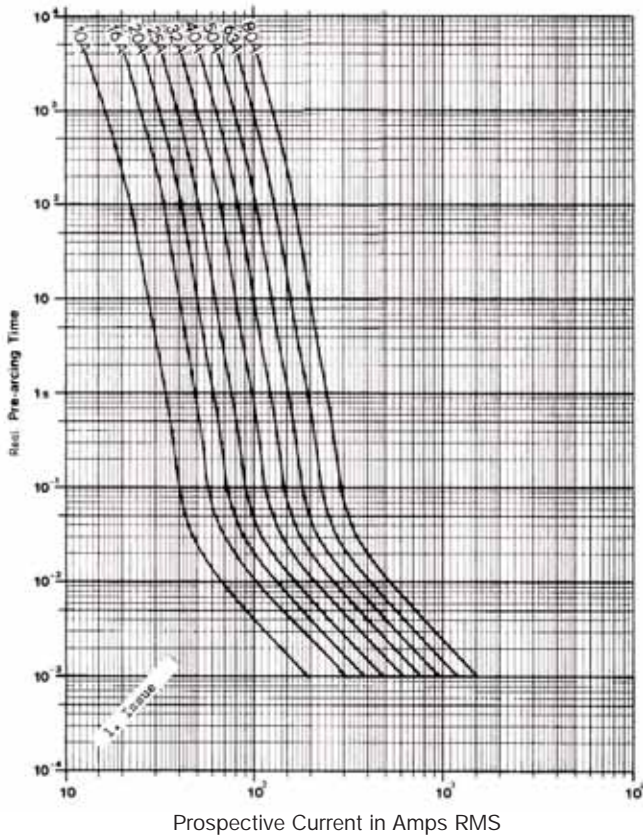

Square Body DC Fuses — 20-125A: 2000V
Time-Current Curve

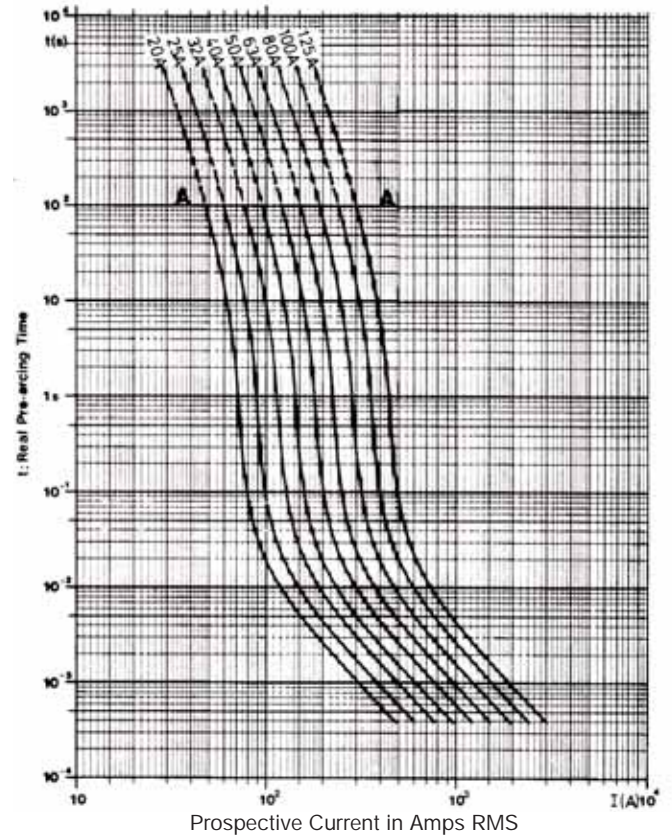

High Speed Fuses

Peak Let-Through Curve

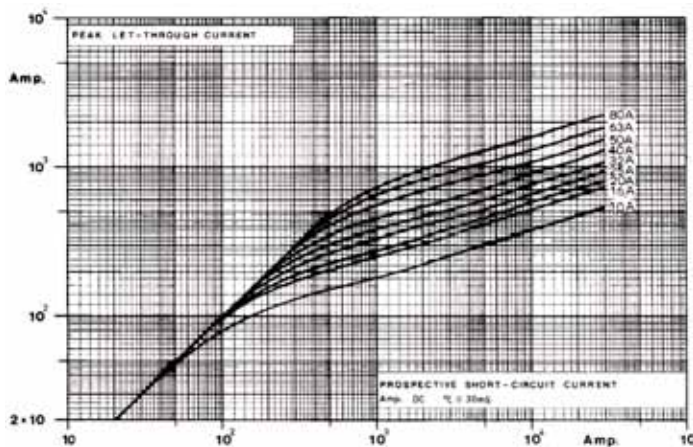

Peak Let-Through Curve

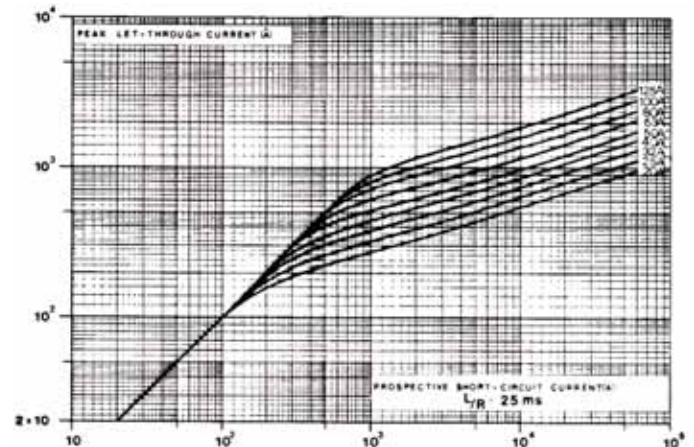

Data Sheet: Available upon request

Data Sheet: Available upon request

Square Body DC Fuses — 4000Vdc: 20-450A

4000Vdc 20-450A

Specifications

Description: High speed fuses for the protection of DC circuits in equipment.

Dimensions: See dimensions illustration.

Ratings:

Volts: — 4000Vdc

Amps: — 20-450A

IR: — 60kA L/R: 25 ms.

Agency Information: Consult Cooper Bussmann.

Electrical Characteristics

Arc Voltage

This curve gives the peak arc voltage, U_L , which may appear across the fuse during its operation as a function of the applied working voltage E_g .

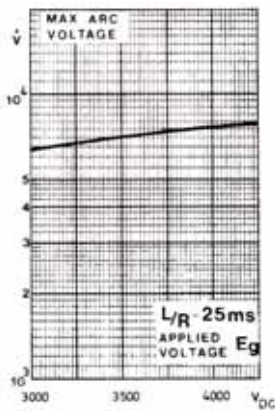

Power Losses

Watts loss at rated current is given in the electrical characteristics. The curve allows the calculation of the power losses at load currents lower than the rated current. The correction factor, K_p , is given as a function of the RMS load current, I_b , in % of the rated current.

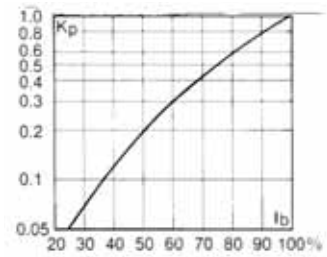

Features and Benefits

- Excellent DC performance
- Low arc voltage and low energy let-through (I^2t)
- Low watts loss
- Superior cycling capability

Typical Applications

- DC common bus
- DC drives
- Power converters/rectifiers
- Reduced voltage starters

Catalog Numbers

Fuse Type	Cat. Numbers		Electrical Characteristics	
	-SKN/394 Type K Indicator	Rated Voltage (Vdc)	Rated Current RMS-Amp	Watts Loss (W)
1*SKN/394	170E3914	4000	20	23
	170E3915		25	28
	170E3916		32	34
	170E3917		40	45
	170E3918		50	57
	170E3919		63	72
	170E3984		80	91
	170E3922		125	143
2 SKN/394	170E8882	4000	160	182
	170E8883		200	228
	170E8884		250	285
2//2SKN/394	170E8885	4000	315	360
	170E8886		350	400
	170E8887		400	455
	170E8888		450	515

DC Fuses — 4000Vdc: 20-450A

DC Fuses

4000Vdc / 20 - 450A

Dimensions (mm):

Type 1*SKN/394

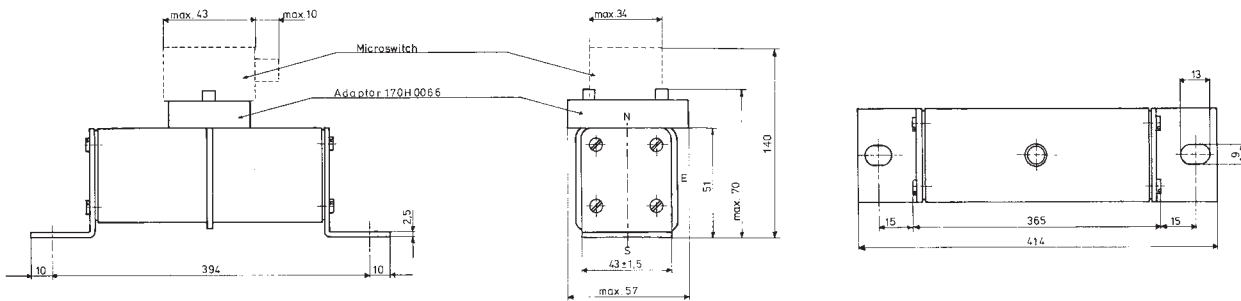

Type 2SKN/394

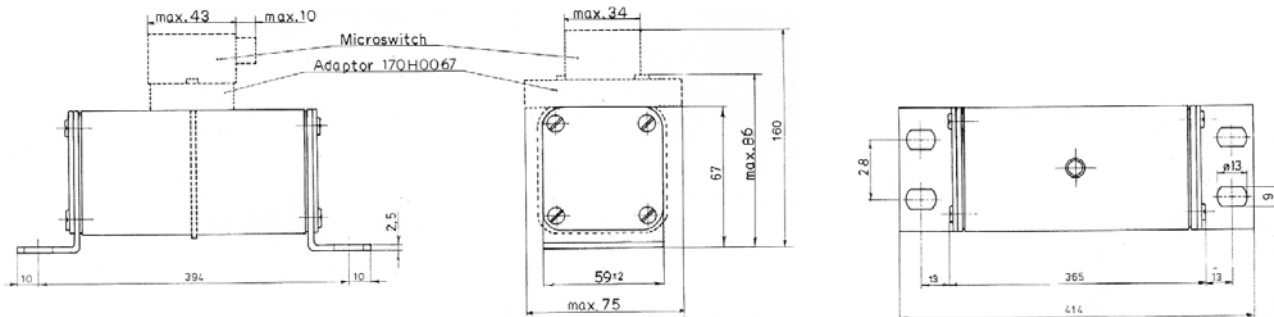

Type 2//SKN/394

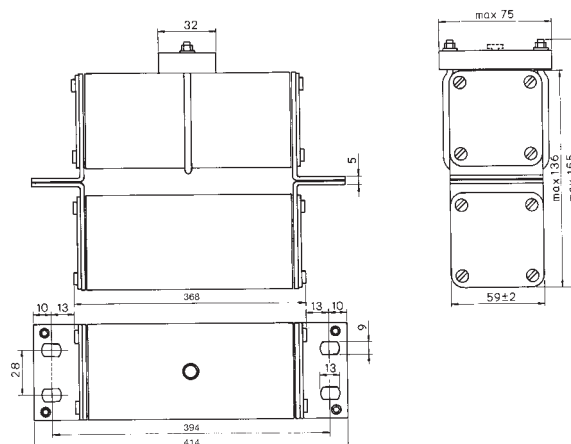

High Speed Fuses

Square Body DC Fuses — 4000Vdc: 20-450A

Square Body DC Fuses — 20-125A: 2000V
Time-Current Curve

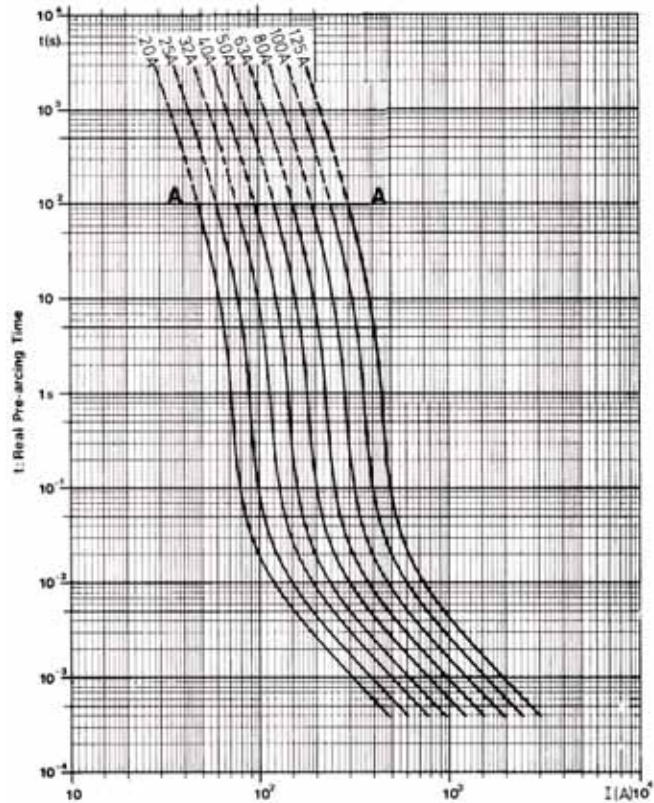

Prospective Current in Amps RMS

Square Body DC Fuses — 160-450A: 4000V
Time-Current Curve

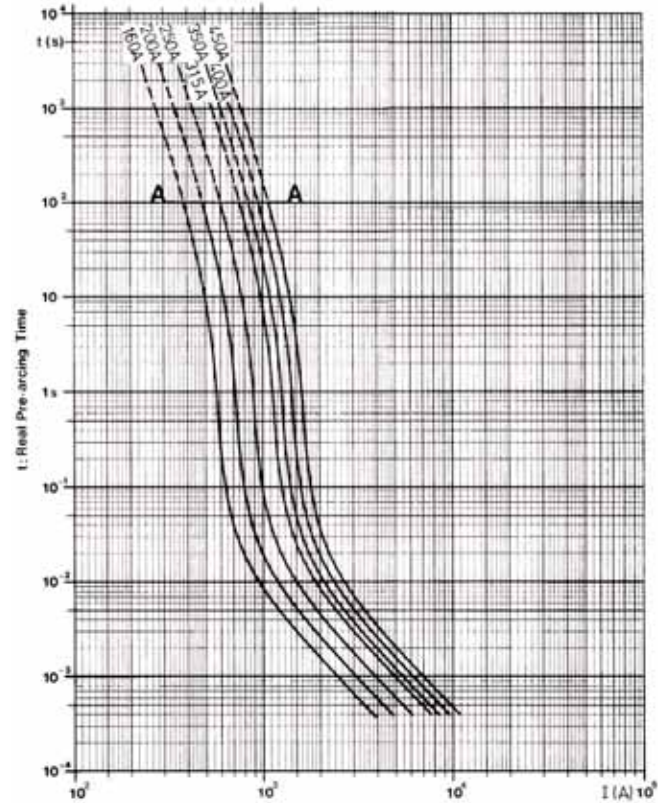

Prospective Current in Amps RMS

Peak Let-Through Curve

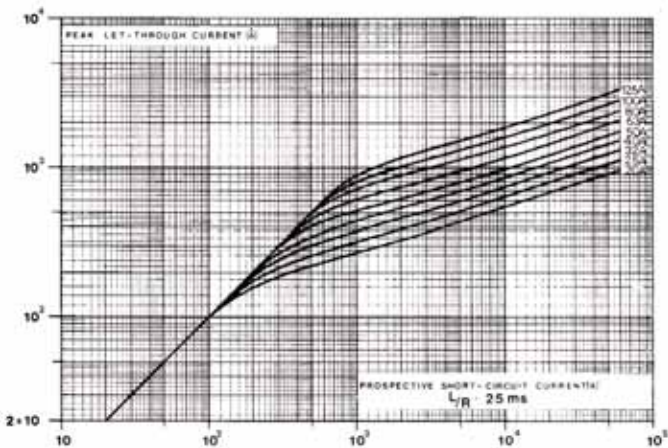

Peak Let-Through Curve

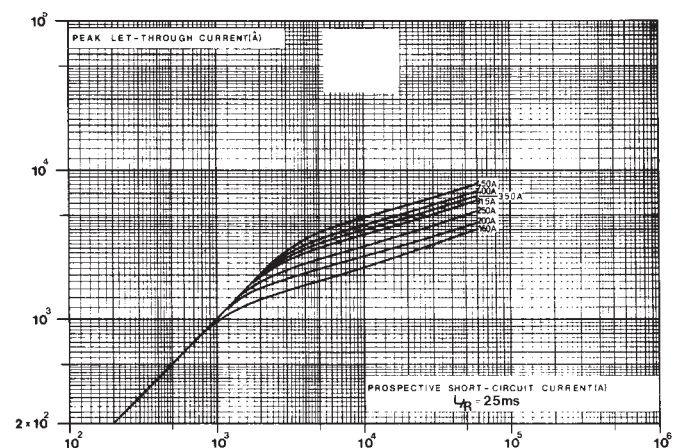

Data Sheet: Available upon request

Data Sheet: Available upon request

Square Body Fuse Accessories

Indicator Systems

Typower ZILOX fuses are available with three different indicator systems.

1. Visual Indicator

The indicator situated in one cover plate is clearly visible as soon as the fuse has operated. The minimum voltage for operating the indicator is 20V.

2. Type T Indicator

The indicator is situated on one cover plate with a cover plate tag to accommodate an auxiliary switch. The minimum voltage for operating the indicator is 20V. A special low voltage indicator (1.5V) is available on request.

3. Type K Indicator

This indicator is situated on the fuse body. It is covered by an adapter for snap-on mounting of an auxiliary switch. The operating voltage of the indicator is 1.5V. As a matter of safety, the factory mounted adapter must not be removed from the fuse.



High Speed Fuses

Microswitch

The Typower ZILOX fuses with either type T indicator or type K indicator can be equipped with a microswitch for remote electrical indication of fuse operations. All micro-switches have one normally open and one normally closed contact. Ratings are 2A, 250Vac.

Microswitch	6.3 x 0.8mm Lugs	2.8 x 0.5mm Lugs	Indicator Type
170H0235	X		T
170H0236	X		T
170H0237		X	T
170H0238		X	T
170H0069	X		K

Size	DIN 43 653 Type T	Type K	DIN 43 620 Type T	Type K	French Style Type T	Type K	Flush End Type T	Type K	US Style Type K
000	170H0236		170H0236						
	170H0238		170H0238						
00	170H0235						170H0235		
	170H0237						170H0237		
1*	170H0235	170H0069	170H0235		170H0236	170H0069		170H0069	170H0069
	170H0237		170H0237		170H0238				
1	170H0235	170H0069			170H0236	170H0069		170H0069	170H0069
	170H0237				170H0238				
2	170H0235	170H0069	170H0235		170H0236	170H0069		170H0069	170H0069
	170H0237		170H0237		170H0238				
3	170H0235	170H0069	170H0236		170H0236	170H0069		170H0069	170H0069
	170H0237		170H0238		170H0238				
4								170H0069	
23								170H0069	
24								170H0069	

Square Body Fuse Accessories

Fuse Bases (Blocks)

DIN 43 653 Fuse Bases

For the Typower ZILOX fuses according to DIN 43 653, the following fuse bases are available:

Catalog Number	Max Volts	Amp Rating	Center Distance
170H3003	1000	630	80mm
170H3004	1000	1250	80mm
170H3005	1400	630	110mm
170H3006	1400	1250	110mm

The fuse bases rated 1250A can also be used for the fuses with higher rated current if the maximum load current is derated according to the table below:

Fuse Amp Rating	Max Amp Load In Fuse Base
1400	1325
1500	1400
1600	1500
1800	1650
2000	1800

Fixed Center Base Style	Max Volts	Max. Fuse Amp Rating	Fuse Size
170H1007	1000	400	00, 000
170H1013	660	200	0000,000

UL Recognized to UL 512.

Universal Fuse Bases

For the Typower ZILOX fuses according to DIN 43 653, French style and North American style, the following fuse bases are available:

Modular Base Style	Max Volts	Max. Fuse Amp Rating	Data Sheet
1BS101	600	100	1206
1BS102	600	400	1207
1BS103	600	400	1208
1BS104	600	600	1209
BH-0xxx	700	200	1200
BH-1xxx	2500	400	1201
BH-2xxx	5000	400	1202
BH-3xxx	1250	700	1203

Modular fuse bases are UL Recognized to UL 512 and meet the spacing requirements of UL 347. Contact your Cooper Bussmann sales representative for more complete ordering information.

DIN 43 620 Fuse Bases

Size	Part Number
000-00	SB00-D
1*, 1	SB1-D
2,3	SB2-D

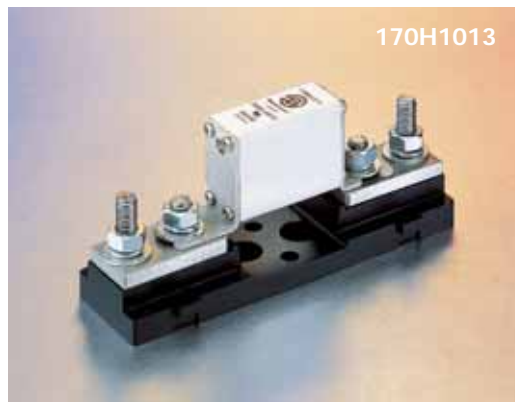

Mouser Electronics

Authorized Distributor

Click to View Pricing, Inventory, Delivery & Lifecycle Information:

Eaton:

<u>170M2719</u>	<u>170M3531</u>	<u>170M3532</u>	<u>170M3534</u>	<u>170M3535</u>	<u>170M3537</u>	<u>170M3538</u>	<u>170M3539</u>	<u>170M3540</u>	<u>170M3541</u>
<u>170M3921</u>	<u>170M3922</u>	<u>170M3923</u>	<u>170M3924</u>	<u>170M3925</u>	<u>170M3926</u>	<u>170M3927</u>	<u>170M3928</u>	<u>170M3929</u>	<u>170M3930</u>
<u>170M3931</u>	<u>170M3951</u>	<u>170M3952</u>	<u>170M3955</u>	<u>170M3965</u>	<u>170M3973</u>	<u>170M4531</u>	<u>170M4533</u>	<u>170M4534</u>	<u>170M4537</u>
<u>170M4539</u>	<u>170M4921</u>	<u>170M4923</u>	<u>170M4924</u>	<u>170M4925</u>	<u>170M4927</u>	<u>170M4928</u>	<u>170M4930</u>	<u>170M4951</u>	<u>170M4954</u>
<u>170M4957</u>	<u>170M4959</u>	<u>170M4965</u>	<u>170M4967</u>	<u>170M4973</u>	<u>170M5531</u>	<u>170M5532</u>	<u>170M5533</u>	<u>170M5534</u>	<u>170M5535</u>
<u>170M5536</u>	<u>170M5537</u>	<u>170M5538</u>	<u>170M5539</u>	<u>170M5923</u>	<u>170M5924</u>	<u>170M5925</u>	<u>170M5926</u>	<u>170M5927</u>	<u>170M5928</u>
<u>170M5929</u>	<u>170M5967</u>	<u>170M8500</u>	<u>170M8501</u>	<u>170M8502</u>	<u>170M8504</u>	<u>170M8505</u>	<u>170M8507</u>	<u>170M8510</u>	<u>170M8512</u>
<u>170M8531</u>	<u>170M8532</u>	<u>170M8533</u>	<u>170M8534</u>	<u>170M8535</u>	<u>170M8538</u>	<u>170M8544</u>	<u>170M8600</u>	<u>170M8601</u>	<u>170M8602</u>
<u>170M8615</u>	<u>170M8619</u>	<u>170M8627</u>	<u>170M8629</u>	<u>170M8630</u>					