

Inductors for power circuits
Wound metal
BCL series (for automotive)



AEC-Q200

BCL322520RT-D type



FEATURES

- The adoption of the new method has resulted in a high inductance that could not be achieved with conventional metallic materials.
- Due to the properties of metallic materials, they are more able to handle larger currents than ferrite materials.
- The use of high- μ materials has made it possible to achieve low Rdc in metal products.
- The coil is fully encapsulated with a magnetic material to minimize leakage flux.
- Supports rated voltage of 40V.
- Operating temperature range: -55 to $+155^{\circ}\text{C}$ (including self-temperature rise)
- Compliant with AEC-Q200.

APPLICATION

- ADAS to Level5 for Camera

PART NUMBER CONSTRUCTION

BCL	322520	RT	-	470	M	-	D
Series name	LxWxH dimensions 3.2x2.5x2.0 mm	Internal code		Inductance (μH)	Inductance tolerance		Internal code

CHARACTERISTICS SPECIFICATION TABLE

L (μH)	Tolerance	Measuring frequency (MHz)	DC resistance		Rated current*			Part No.
			(Ω)max.	(Ω)typ.	Isat (A)max.	(A)typ.	Itemp (A)typ.	
2.2	$\pm 20\%$	1	0.064	0.055	3.45	4.31	3.21	BCL322520RT-2R2M-D
3.3	$\pm 20\%$	1	0.078	0.068	3.13	3.91	2.99	BCL322520RT-3R3M-D
4.7	$\pm 20\%$	1	0.11	0.09	2.50	3.12	2.52	BCL322520RT-4R7M-D
6.8	$\pm 20\%$	1	0.18	0.16	2.24	2.80	1.87	BCL322520RT-6R8M-D
10	$\pm 20\%$	1	0.23	0.20	1.71	2.14	1.72	BCL322520RT-100M-D
15	$\pm 20\%$	1	0.32	0.28	1.33	1.67	1.47	BCL322520RT-150M-D
22	$\pm 20\%$	1	0.46	0.40	1.20	1.49	1.20	BCL322520RT-220M-D
33	$\pm 20\%$	1	0.67	0.59	0.92	1.16	0.99	BCL322520RT-330M-D
47	$\pm 20\%$	1	1.05	0.91	0.80	1.00	0.78	BCL322520RT-470M-D
68	$\pm 20\%$	1	1.63	1.42	0.68	0.84	0.62	BCL322520RT-680M-D
101	$\pm 20\%$	1	2.29	1.99	0.56	0.70	0.52	BCL322520RT-101M-D

* Rated current: smaller value of either Isat or Itemp.

Isat: When based on the inductance change rate (30% below the nominal value)

Itemp: When based on the temperature increase (temperature increase of 40°C by self heating)

Measurement equipment

Measurement item	Product No.	Manufacturer
L	E4990A	Keysight Technologies
DC resistance	AX-114N	ADEX

* Equivalent measurement equipment may be used.



BCL322520RT-D type

L FREQUENCY CHARACTERISTICS

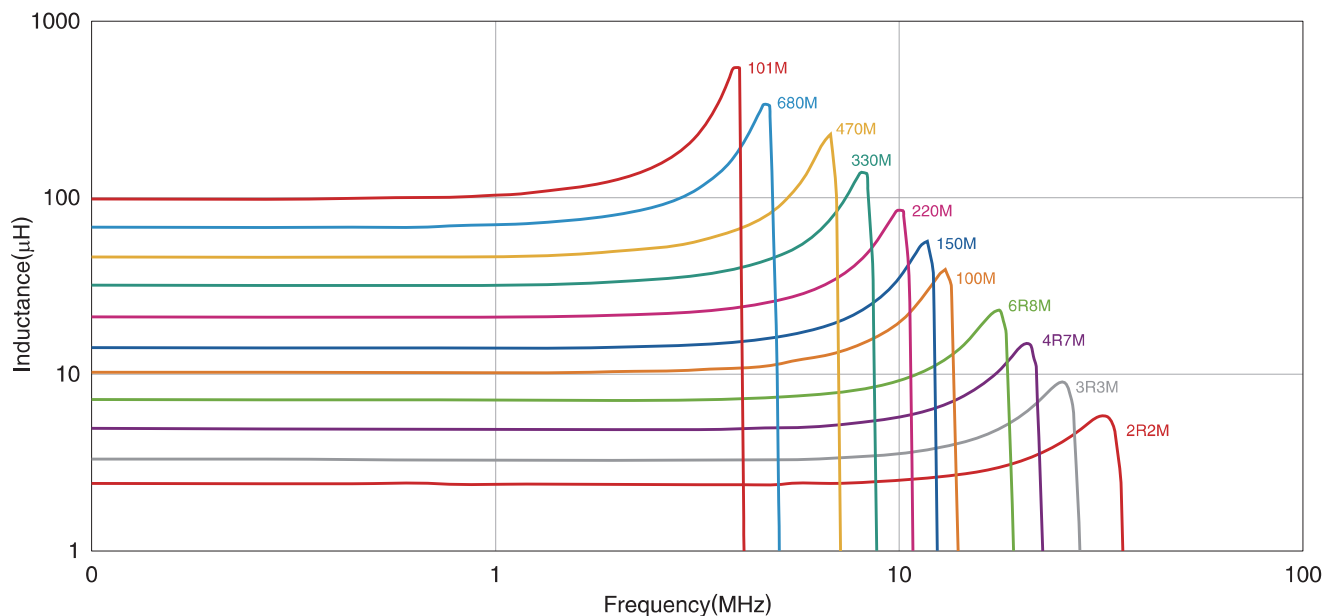

Measurement equipment

Product No.	Manufacturer
E4990A	Keysight Technologies

* Equivalent measurement equipment may be used.

L VS. DC BIAS CHARACTERISTICS

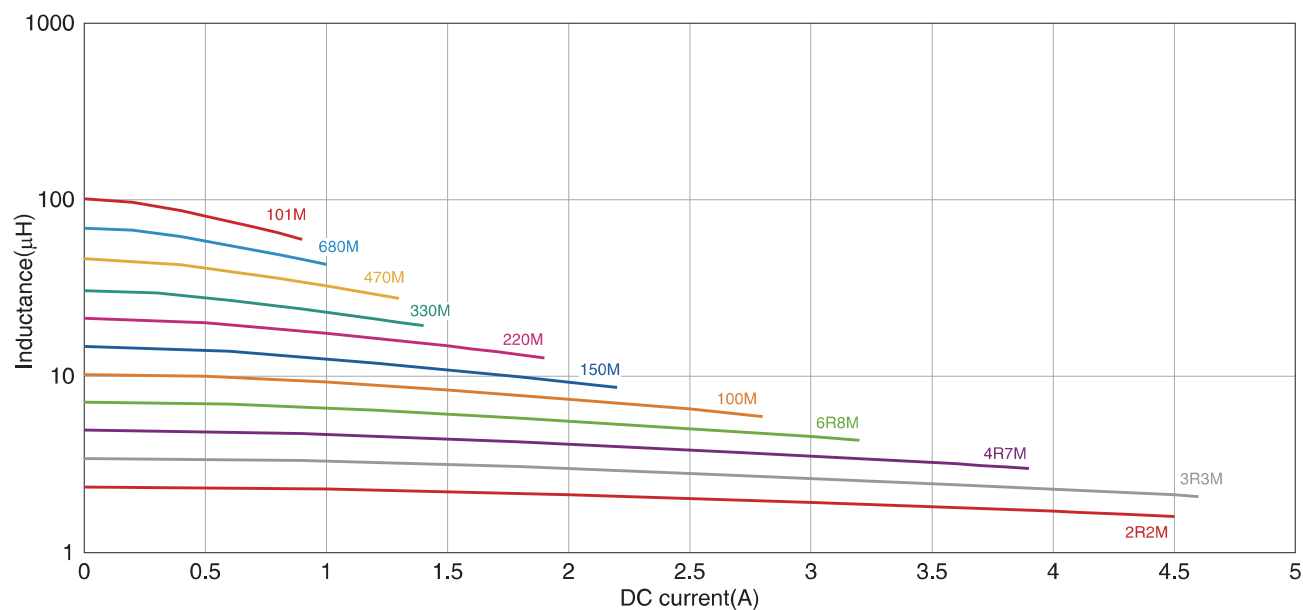

Measurement equipment

Product No.	Manufacturer
6500B	KUWAKI ELECTRONICS

* Equivalent measurement equipment may be used.

BCL322520RT-D type

SHAPE & DIMENSIONS

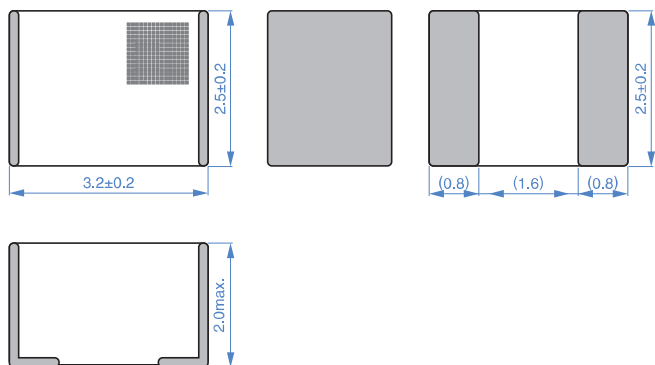

Dimensions in mm

REEL DIMENSIONS

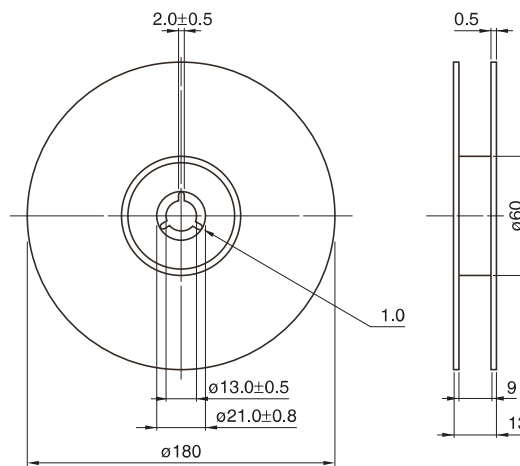

Dimensions in mm

RECOMMENDED LAND PATTERN

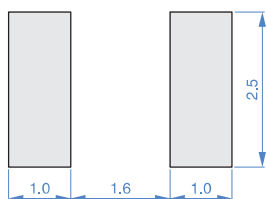

Dimensions in mm

TAPE DIMENSIONS

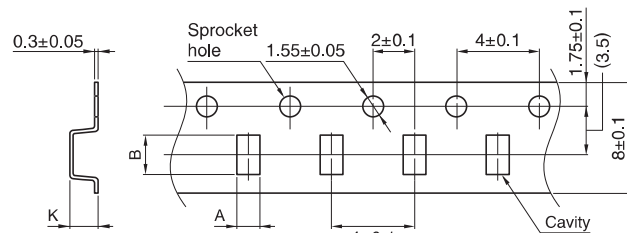

Dimensions in mm

Type	A	B	K
BCL322520RT-D	(2.8)	(3.5)	2.15 ± 0.1

RECOMMENDED REFLOW PROFILE

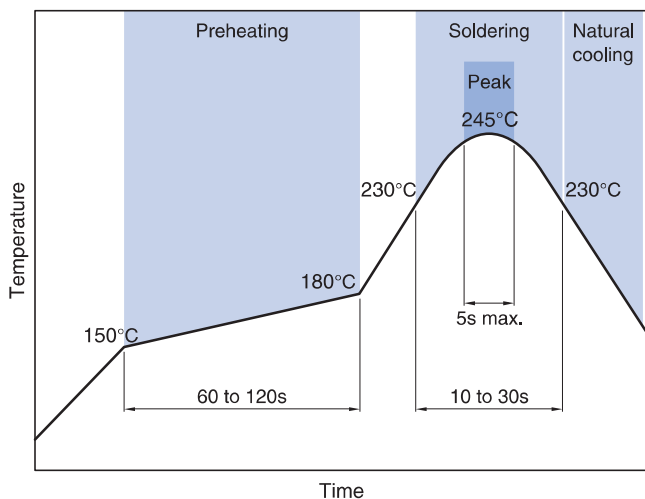

PACKAGE QUANTITY

Package quantity	1500 pcs/reel
------------------	---------------

TEMPERATURE RANGE, INDIVIDUAL WEIGHT

Operating temperature range*	Storage temperature range	Individual weight
-55 to $+155^\circ\text{C}$	-55 to $+155^\circ\text{C}$	0.093 g

* Operating temperature range includes self-temperature rise.

PACKAGING STYLE

REMINDERS FOR USING THESE PRODUCTS

Before using these products, be sure to request the delivery specifications.

SAFETY REMINDERS

Please pay sufficient attention to the warnings for safe designing when using this products.

REMINDERS

- The storage period is within 12 months. Be sure to follow the storage conditions (temperature: 5 to 40°C, humidity: 10 to 75% RH or less).
If the storage period elapses, the soldering of the terminal electrodes may deteriorate.
- Do not use or store in locations where there are conditions such as gas corrosion (salt, acid, alkali, etc.).
- Storage conditions after mounting: -55°C to +155°C
- Soldering corrections after mounting should be within the range of the conditions determined in the specifications.
If overheated, a short circuit, performance deterioration, or lifespan shortening may occur.
- Do not use products that have received any excessive mechanical shock such as by being dropped.
- When embedding a printed circuit board where a chip is mounted to a set, be sure that residual stress is not given to the chip due to the overall distortion of the printed circuit board and partial distortion such as at screw tightening portions.
- Self heating (temperature increase) occurs when the power is turned ON, so the tolerance should be sufficient for the set thermal design.
- Do not expose the products to magnets or magnetic fields.
- The performance of the product may deteriorate if coating materials are used, thus please assess the situation beforehand by taking this factor into consideration.
- Do not use for a purpose outside of the contents regulated in the delivery specifications.
- The products described in this catalog are intended to be installed in automobiles or automotive electronic equipment (AV equipment, telecommunications equipment, home appliances, amusement equipment, computer equipment, personal equipment, office equipment, measurement equipment, industrial robots) and to be used in automobiles (including the case where the said automotive product is mounted in a vehicle) or standard applications as general electronic equipment in automotive applications or standard applications as general electronic equipment in automotive applications in accordance with the scope and conditions described in this specification, while the said automotive or general electronic equipment including the said product is intended to be used in the usual operation and usage methods, respectively. Other than automotive or automotive products are not designed or warranted to meet the requirements of the applications listed below, whose performance and/or quality requires a more stringent level of safety or reliability, or whose failure, malfunction or defect could cause serious damage to society, person or property.
Please understand that we are not responsible for any damage or liability caused by use of the products in any of the applications below or for any other use exceeding the range or conditions set forth in this specification sheet.
If you intend to use the products in the applications listed below or if you have special requirements exceeding the range or conditions set forth in this specification, please contact us.

- (1) Aerospace/aviation equipment
- (2) Transportation equipment (electric trains, ships, etc.)
- (3) Medical equipment
- (4) Power-generation control equipment
- (5) Atomic energy-related equipment
- (6) Seabed equipment
- (7) Transportation control equipment

- (8) Public information-processing equipment
- (9) Military equipment
- (10) Electric heating apparatus, burning equipment
- (11) Disaster prevention/crime prevention equipment
- (12) Safety equipment
- (13) Other applications that are not considered general-purpose applications

When designing your equipment even for general-purpose applications, you are kindly requested to take into consideration securing protection circuit/device or providing backup circuits in your equipment.