

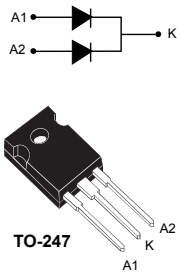

## 2 X 15 A, 1200 V power Schottky silicon carbide diode



### Features

- AEC-Q101 qualified 
- No or negligible reverse recovery
- Switching behavior independent of temperature
- Robust high-voltage periphery
- PPAP capable
- Operating  $T_j$  from  $-40\text{ °C}$  to  $175\text{ °C}$
- ECOPACK 2 compliant

### Applications

- OBC (on board battery chargers)
- PHEV - EV charging stations
- Resonant LLC topology
- PFC functions (power factor corrector)

### Description

The SiC diode, available in TO-247, is an ultrahigh performance power Schottky rectifier. It is manufactured using a silicon carbide substrate. The wide band-gap material allows the design of a low  $V_F$  Schottky diode structure with a 1200 V rating.

Due to the Schottky construction, no recovery is shown at turn-off and ringing patterns are negligible. The minimal capacitive turn-off behavior is independent of temperature.

Especially suited for use in PFC and secondary side applications, this ST SiC diode will boost the performance in hard switching conditions. This rectifier will enhance the performance of the targeted application. Its high forward surge capability ensures a good robustness during transient phases.

#### Product status link

[STPSC31H12C-Y](#)

#### Product summary

$I_{F(AV)}$	2 x 15 A
$V_{RRM}$	1200 V
$T_j$ (max.)	175 °C
$V_F$ (typ.)	1.35 V

#### Product label



# 1 Characteristics

**Table 1. Absolute ratings (limiting values per diode at 25 °C , unless otherwise specified)**

Symbol	Parameter		Value	Unit	
$V_{RRM}$	Repetitive peak reverse voltage ( $T_j = -40\text{ °C}$ to $+175\text{ °C}$ )		1200	V	
$I_{F(RMS)}$	Forward rms current		38	A	
$I_{F(AV)}$	Average forward current	$T_c = 150\text{ °C}$ , DC current	Per diode	15	A
			Per device	30	
$I_{FSM}$	Surge non repetitive forward current	$t_p = 10\text{ ms}$ sinusoidal	$T_c = 25\text{ °C}$	105	A
		$t_p = 10\text{ ms}$ sinusoidal	$T_c = 125\text{ °C}$	90	
$T_{stg}$	Storage temperature range		-55 to +175	°C	
$T_j$	Operating junction temperature <sup>(1)</sup>		-40 to +175	°C	

1.  $(dP_{tot}/dT_j) < (1/R_{th(j-a)})$  condition to avoid thermal runaway for a diode on its own heatsink.

**Table 2. Thermal resistance parameters**

Symbol	Parameter	Value		Unit	
		Typ.	Max.		
$R_{th(j-c)}$	Junction to case	Per diode	0.50	0.70	°C/W
		Per device	0.25	0.35	

For more information, please refer to the following application note:

- AN5088: Rectifiers thermal management, handling and mounting recommendations

**Table 3. Static electrical characteristics (per diode)**

Symbol	Parameter	Test conditions		Min.	Typ.	Max.	Unit
$I_R$ <sup>(1)</sup>	Reverse leakage current	$T_j = 25\text{ °C}$	$V_R = V_{RRM}$	-	7.5	90	μA
		$T_j = 150\text{ °C}$		-	45	600	
$V_F$ <sup>(2)</sup>	Forward voltage drop	$T_j = 25\text{ °C}$	$I_F = 15\text{ A}$	-	1.35	1.50	V
		$T_j = 150\text{ °C}$		-	1.75	2.25	

1. Pulse test:  $t_p = 10\text{ ms}$ ,  $\delta < 2\%$

2. Pulse test:  $t_p = 500\text{ μs}$ ,  $\delta < 2\%$

To evaluate the conduction losses, use the following equation:

$$P = 1.09 \times I_{F(AV)} + 0.0775 \times I_{F(RMS)}^2$$

For more information, please refer to the following application notes related to the power losses:

- AN604: Calculation of conduction losses in a power rectifier
- AN4021: Calculation of reverse losses on a power diode

**Table 4. Dynamic electrical characteristics (per diode)**

Symbol	Parameter	Test conditions	Min.	Typ.	Max.	Unit
$Q_{Cj}^{(1)}$	Total capacitive charge	$V_R = 800\text{ V}$	-	94	-	nC
$C_j$	Total capacitance	$V_R = 0\text{ V}, T_c = 25\text{ }^\circ\text{C}, F = 1\text{ MHz}$	-	1200	-	pF
		$V_R = 800\text{ V}, T_c = 25\text{ }^\circ\text{C}, F = 1\text{ MHz}$	-	78	-	

1. Most accurate value for the capacitive charge:  $Q_{Cj}(V_R) = \int_0^{V_R} C_j(V) dV$

## 1.1 Characteristics (curves)

**Figure 1. Forward voltage drop versus forward current (typical values, per diode)**

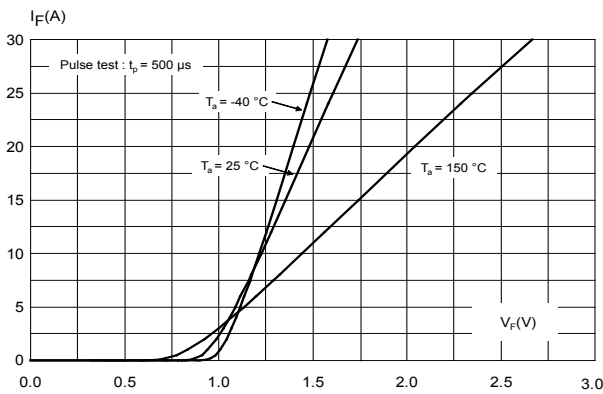

**Figure 2. Reverse leakage current versus reverse voltage applied (typical values, per diode)**

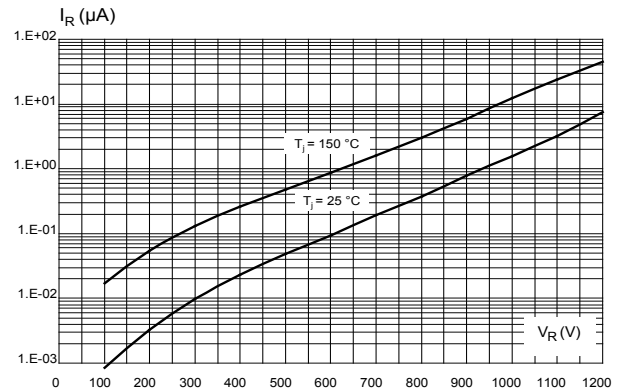

**Figure 3. Peak forward current versus case temperature (per diode)**

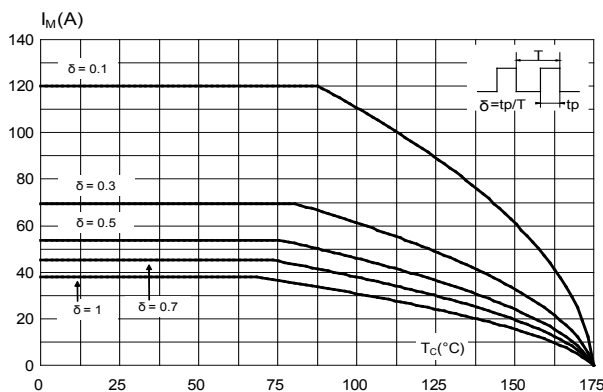

**Figure 4. Junction capacitance versus reverse voltage applied (typical values, per diode)**

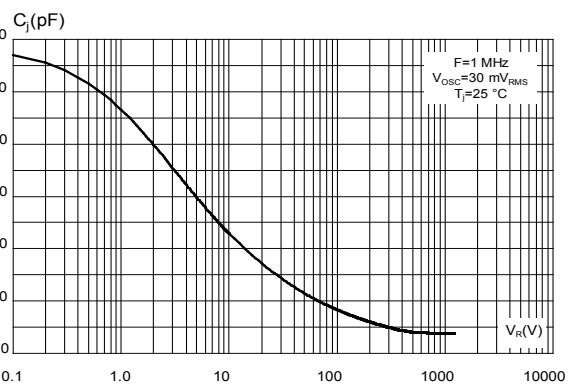

**Figure 5. Relative variation of thermal impedance junction to case versus pulse duration**

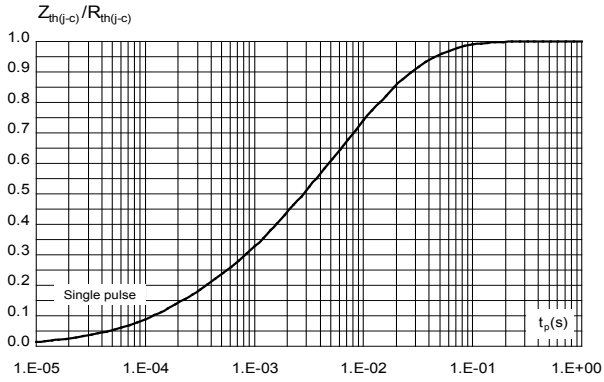

**Figure 6. Non-repetitive peak surge forward current versus pulse duration (sinusoidal waveform, per diode)**

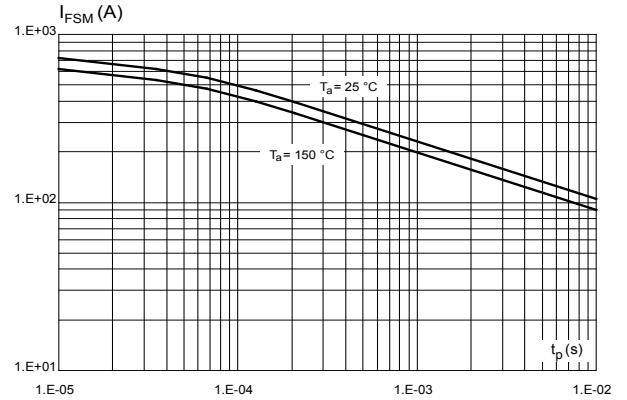

**Figure 7. Total capacitive charges versus reverse voltage applied (typical values, per diode)**

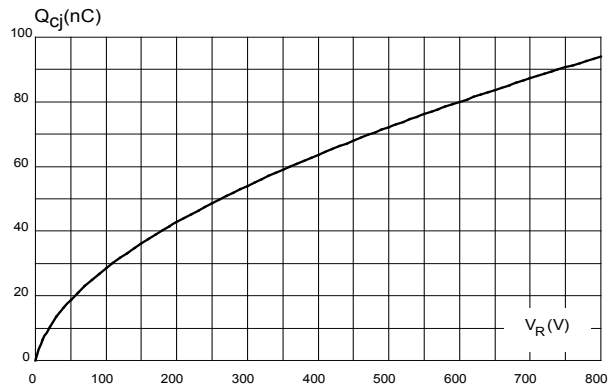

## 2 Package information

In order to meet environmental requirements, ST offers these devices in different grades of **ECOPACK** packages, depending on their level of environmental compliance. ECOPACK specifications, grade definitions and product status are available at: [www.st.com](http://www.st.com). ECOPACK is an ST trademark.

### 2.1 TO-247 package information

- Epoxy meets UL94, V0
- Cooling method: by conduction (C)
- Recommended torque value: 0.8 N·m
- Maximum torque value: 1.0 N·m

Figure 8. TO-247 package outline

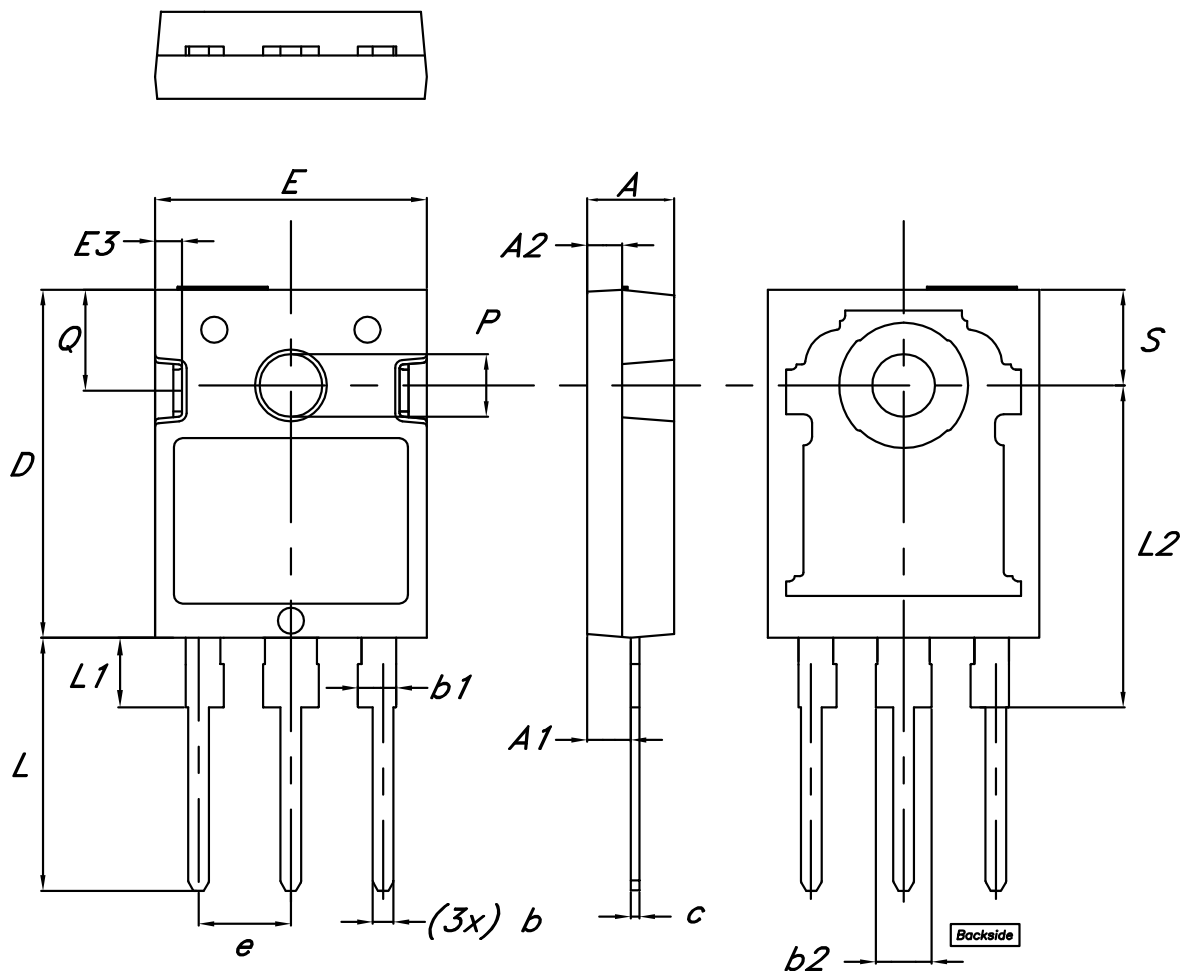

**Table 5. TO-247 package mechanical data**

Ref.	Dimensions					
	Millimeters			Inches (for reference only)		
	Min.	Typ.	Max.	Min.	Typ.	Max.
A	4.85	5.00	5.15	0.191	0.197	0.203
A1	2.20		2.60	0.086		0.102
A2	1.90	2.00	2.10	0.075	0.078	0.083
b	1.00		1.40	0.039		0.055
b1	2.00		2.40	0.078		0.094
b2	3.00		3.40	0.118		0.133
c	0.40		0.80	0.015		0.031
D	19.85	20.00	20.15	0.781	0.787	0.793
E	15.45	15.60	15.75	0.608	0.614	0.620
E3	1.45		1.65	0.057		0.065
e	5.30	5.45	5.60	0.209	0.215	0.220
L	14.20		14.80	0.559		0.582
L1	3.70		4.30	0.145		0.169
L2	18.30	18.50	18.70	0.720	0.728	0.737
ØP	3.55		3.65	0.139		0.143
Q	5.65		5.95	0.222		0.234
S	5.30	5.50	5.70	0.209	0.216	0.224

### 3 Ordering information

**Table 6. Ordering information**

Order code	Marking	Package	Weight	Base qty.	Delivery mode
STPSC31H12CWY	SC31H12CWY	TO-247	5.4 g	30	Tube

## Revision history

**Table 7. Document revision history**

Date	Revision	Changes
20-Apr-2020	1	First issue.
24-Feb-2021	2	Updated <a href="#">Figure 8</a> and <a href="#">Table 5</a> .



**IMPORTANT NOTICE – PLEASE READ CAREFULLY**

STMicroelectronics NV and its subsidiaries (“ST”) reserve the right to make changes, corrections, enhancements, modifications, and improvements to ST products and/or to this document at any time without notice. Purchasers should obtain the latest relevant information on ST products before placing orders. ST products are sold pursuant to ST’s terms and conditions of sale in place at the time of order acknowledgement.

Purchasers are solely responsible for the choice, selection, and use of ST products and ST assumes no liability for application assistance or the design of Purchasers’ products.

No license, express or implied, to any intellectual property right is granted by ST herein.

Resale of ST products with provisions different from the information set forth herein shall void any warranty granted by ST for such product.

ST and the ST logo are trademarks of ST. For additional information about ST trademarks, please refer to [www.st.com/trademarks](http://www.st.com/trademarks). All other product or service names are the property of their respective owners.

Information in this document supersedes and replaces information previously supplied in any prior versions of this document.

© 2021 STMicroelectronics – All rights reserved