

ESDS452 5.5-V Bi-Directional TVS Diode in SOT-23

1 Features

- IEC 61000-4-5 surge protection:
 - 18A (8/20 μ s)
- IEC 61000-4-2 ESD Protection:
 - \pm 30kV contact discharge
 - \pm 30kV air gap discharge
- 5.5V working voltage
- Ultra low leakage current:
 - 1nA (typical)
- I/O Capacitance:
 - 3pF (typical)
- Bidirectional polarity to support positive and negative voltage swings
- 2-ch device provides complete ESD/Surge protection with single component
- Small, leaded SOT-23 allows low cost automatic optical inspection (AOI)

2 Applications

- End equipment:
 - [Factory automation and control](#)
 - [Building automation](#)
 - [Grid infrastructure](#)
 - [HVAC systems](#)
 - [Energy storage systems](#)

3 Description

The ESDS452 is a bidirectional ESD and TVS diode. The ESDS452 is rated to dissipate ESD strikes beyond the maximum level specified in the IEC 61000-4-2 international standard (\pm 30kV Contact, \pm 30kV Air-gap). The device can clamp 8/20 μ s surges with peak pulse currents up to 18A in accordance with the IEC 61000-4-5 standard. Additionally, the low clamping voltage of the diodes in both the positive and negative directions can help prevent downstream circuitry from being exposed to large voltages and currents during ESD or surge events. This protection is key in industrial systems which require a high level of robustness and reliability.

The ESDS452 is available in a small leaded SOT-23 (DBZ) package.

Package Information

PART NUMBER	PACKAGE ⁽¹⁾	PACKAGE SIZE ⁽²⁾
ESDS452	DBZ (SOT-23, 3)	2.92mm × 2.37mm

(1) For more information, see [Section 9](#).

(2) The package size (length x width) is a nominal value and includes pins, where applicable.

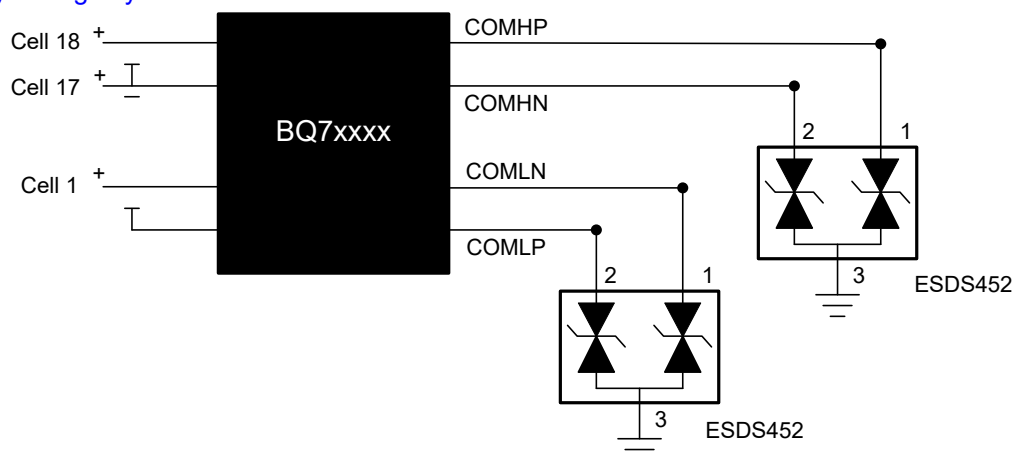

Typical Application for BMS



Table of Contents

1 Features	1	6 Application and Implementation	6
2 Applications	1	6.1 Application Information.....	6
3 Description	1	7 Device and Documentation Support	7
4 Pin Configuration and Functions	2	7.1 Documentation Support.....	7
5 Specifications	3	7.2 Receiving Notification of Documentation Updates.....	7
5.1 Absolute Maximum Ratings.....	3	7.3 Support Resources.....	7
5.2 ESD Ratings -JEDEC Specifications.....	3	7.4 Trademarks.....	7
5.3 ESD Ratings - IEC Specifications.....	3	7.5 Electrostatic Discharge Caution.....	7
5.4 Recommended Operating Conditions.....	3	7.6 Glossary.....	7
5.5 Thermal Information.....	3	8 Revision History	7
5.6 Electrical Characteristics.....	4	9 Mechanical, Packaging, and Orderable Information	7
5.7 Typical Characteristics.....	5		

4 Pin Configuration and Functions

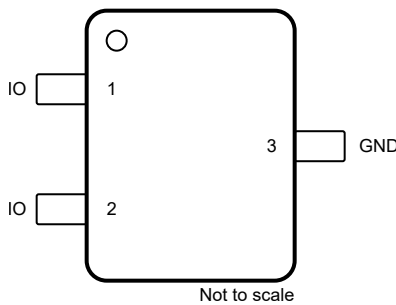

Figure 4-1. ESDS452 DBZ Package, 3-Pin SOT-23 (Top View)

Table 4-1. Pin Functions for ESDS452

PIN		TYPE ⁽¹⁾	DESCRIPTION
NAME	NO.		
IO	1, 2	I/O	Surge and ESD protected IO
GND	3	GND	Ground. Connect to ground

(1) I = Input, O = Output, I/O = Input or Output, GND = ground

5 Specifications

5.1 Absolute Maximum Ratings

over operating free-air temperature range (unless otherwise noted)⁽¹⁾

Parameter		MIN	MAX	UNIT
P _{PPM}	IEC 61000-4-5 Surge (t _p = 8/20μs) Peak Pulse Power at 25 °C		172	W
I _{PPM}	IEC 61000-4-5 Surge (t _p = 8/20μs) Peak Pulse Current at 25 °C		18	A
T _A	Operating free-air temperature	–40	125	°C
T _{stg}	Storage temperature	–65	155	°C

- (1) Operation outside the *Absolute Maximum Ratings* may cause permanent device damage. Absolute maximum ratings do not imply functional operation of the device at these or any other conditions beyond those listed under *Recommended Operating Conditions*. If briefly operating outside the *Recommended Operating Conditions* but within the *Absolute Maximum Ratings*, the device may not sustain damage, but it may not be fully functional. Operating the device in this manner may affect device reliability, functionality, performance, and shorten the device lifetime.

5.2 ESD Ratings -JEDEC Specifications

Parameter		Test Conditions	VALUE	UNIT
V _(ESD)	Electrostatic discharge	Human body model (HBM), per ANSI/ESDA/ JEDEC JS-001, all pins ⁽¹⁾	±2500	V
		Charged device model (CDM), per JEDEC specification JS-002, all pins ⁽²⁾	±1000	

- (1) JEDEC document JEP155 states that 500-V HBM allows safe manufacturing with a standard ESD control process.
(2) JEDEC document JEP157 states that 250-V CDM allows safe manufacturing with a standard ESD control process.

5.3 ESD Ratings - IEC Specifications

Parameter		Test Conditions	VALUE	UNIT
V _(ESD)	Electrostatic discharge	IEC 61000-4-2 Contact Discharge, all pins	±30000	V
		IEC 61000-4-2 Air Discharge, all pins	±30000	

5.4 Recommended Operating Conditions

over operating free-air temperature range (unless otherwise noted)

		MIN	NOM	MAX	UNIT
V _{IN}	Input voltage	–5.5		5.5	V
T _A	Operating Free Air Temperature	–40		125	°C

5.5 Thermal Information

THERMAL METRIC ⁽¹⁾		ESDS452	UNIT
		DBZ (SOT-23)	
		3 PINS	
R _{θJA}	Junction-to-ambient thermal resistance	309.5	°C/W
R _{θJC(top)}	Junction-to-case (top) thermal resistance	162.4	°C/W
R _{θJB}	Junction-to-board thermal resistance	149.0	°C/W
Ψ _{JT}	Junction-to-top characterization parameter	41.0	°C/W
Ψ _{JB}	Junction-to-board characterization parameter	147.9	°C/W
R _{θJC(bot)}	Junction-to-case (bottom) thermal resistance	N/A	°C/W

- (1) For more information about traditional and new thermal metrics, see the [Semiconductor and IC Package Thermal Metrics](#) application report.

5.6 Electrical Characteristics

At TA = 25°C unless otherwise noted

PARAMETER		TEST CONDITIONS	MIN	TYP	MAX	UNIT
V _{RWM}	Reverse stand-off voltage	I _{IO} < 50nA	-5.5		5.5	V
I _{LEAK}	Leakage current at V _{RWM}	V _{IO} = ±5.5 V, I/O to GND and GND to I/O		1	50	nA
V _{BR}	Breakdown voltage, I/O to GND ⁽¹⁾	I _{IO} = ±1mA	7	8	9	V
V _{CLAMP}	Surge clamping voltage, t _p = 8/20 μs ⁽²⁾	I _{PP} = ±1 A, I/O to GND		7.5	10	V
V _{CLAMP}	Surge clamping voltage, t _p = 8/20 μs ⁽²⁾	I _{PP} = ±15 A, I/O to GND		11.5	14	V
V _{CLAMP}	TLP clamping voltage, t _p = 100ns ⁽³⁾	I _{PP} = ±16 A, I/O to GND		9.6		V
R _{DYN}	Dynamic resistance ⁽⁴⁾	I/O to GND		0.29		Ω
		GND to I/O		0.29		
C _{LINE}	Line capacitance, IO to GND	V _{IO} = 0 V, f = 1 MHz		3	5	pF

- (1) V_{BR} is defined as the voltage when ±1mA is applied in the positive or negative direction respectively.
(2) Device stressed with 8/20 μs exponential decay waveform according to IEC 61000-4-5
(3) Non-repetitive square wave current pulse, Transmission Line Pulse (TLP); ANSI / ESD STM5.5.1-2008
(4) 8/20 μs (IEC 61000-4-5) dynamic resistance

5.7 Typical Characteristics

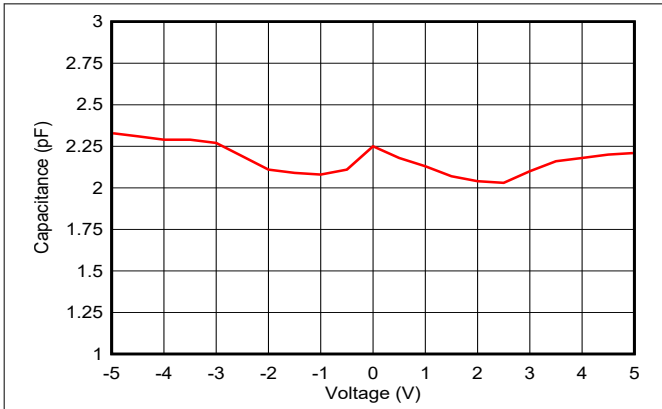

Figure 5-1. Capacitance vs. Bias Voltage

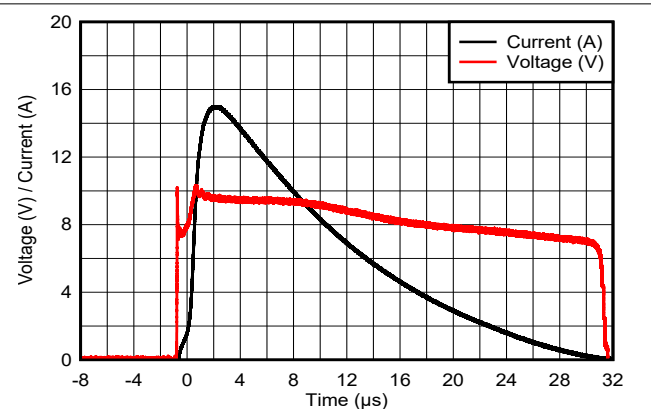

Figure 5-2. 8/20µs Surge Response

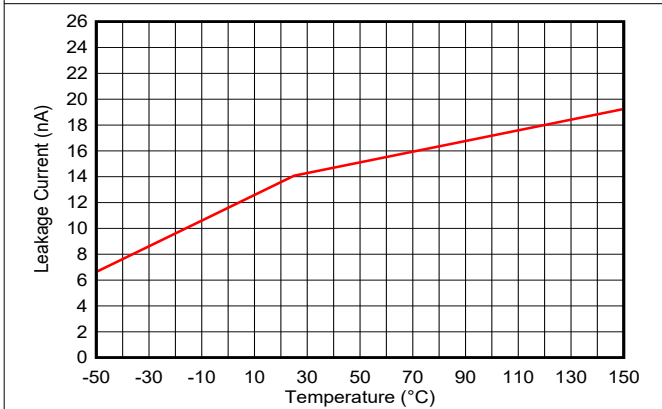

Figure 5-3. Leakage Current vs. Temperature

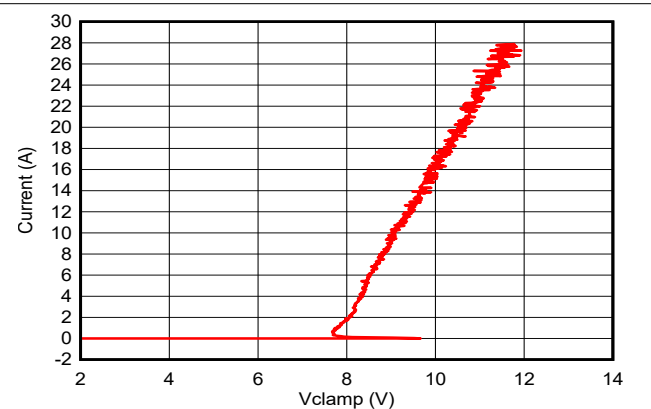

Figure 5-4. Positive TLP Curve

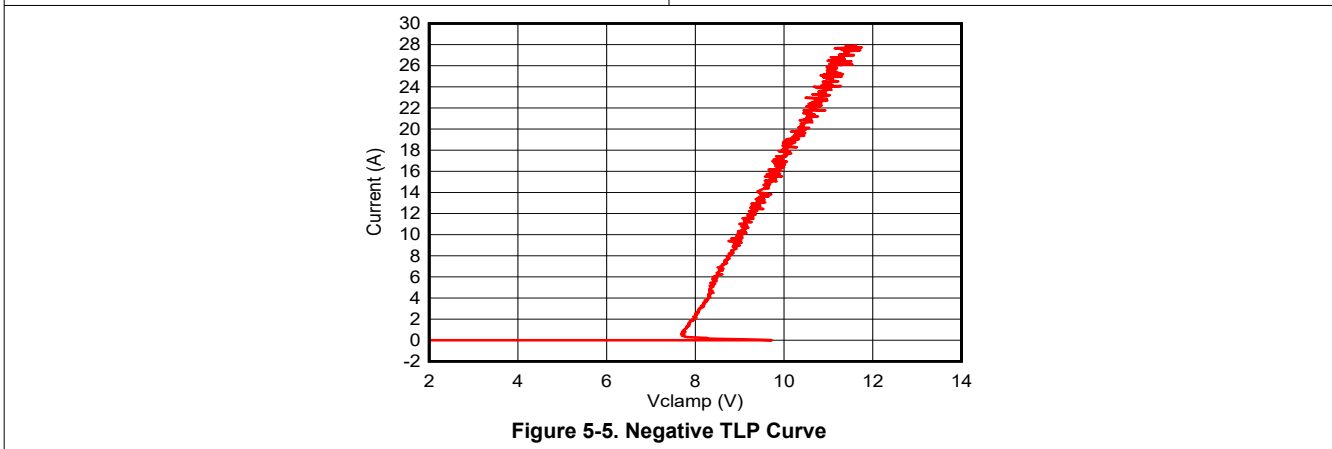

Figure 5-5. Negative TLP Curve

6 Application and Implementation

Note

Information in the following applications sections is not part of the TI component specification, and TI does not warrant its accuracy or completeness. TI's customers are responsible for determining suitability of components for their purposes, as well as validating and testing their design implementation to confirm system functionality.

6.1 Application Information

The ESDS452 is a diode type TVS which provides a path to ground for dissipating transient voltage spikes, such as ESD or surge, on signal lines and power lines. Connect the device in parallel to the down stream circuitry for protection. As the current from the transient passes through the device, only a small voltage drop is present across the diode. This is the voltage presented to the protected IC. The low R_{DYN} of the triggered TVS holds this voltage (V_{CLAMP}) to a safe level for the protected IC. For more information on how to properly use this device, refer to the [ESD Packaging and Layout Guide](#).

7 Device and Documentation Support

7.1 Documentation Support

7.1.1 Related Documentation

For related documentation, see the following:

- Texas Instruments, [ESD Packaging and Layout Guide](#)
- Texas Instruments, [TI's IEC 61000-4-x Testing application note](#)
- Texas Instruments, [ESD Layout Guide user's guide](#)
- Texas Instruments, [ESD Protection Diodes EVM user's guide](#)
- Texas Instruments, [Generic ESD Evaluation Module user's guide](#)
- Texas Instruments, [Reading and Understanding an ESD Protection Data Sheet user's guide](#)

7.2 Receiving Notification of Documentation Updates

To receive notification of documentation updates, navigate to the device product folder on [ti.com](#). Click on *Notifications* to register and receive a weekly digest of any product information that has changed. For change details, review the revision history included in any revised document.

7.3 Support Resources

[TI E2E™ support forums](#) are an engineer's go-to source for fast, verified answers and design help — straight from the experts. Search existing answers or ask your own question to get the quick design help you need.

Linked content is provided "AS IS" by the respective contributors. They do not constitute TI specifications and do not necessarily reflect TI's views; see TI's [Terms of Use](#).

7.4 Trademarks

TI E2E™ is a trademark of Texas Instruments.
All trademarks are the property of their respective owners.

7.5 Electrostatic Discharge Caution



This integrated circuit can be damaged by ESD. Texas Instruments recommends that all integrated circuits be handled with appropriate precautions. Failure to observe proper handling and installation procedures can cause damage.

ESD damage can range from subtle performance degradation to complete device failure. Precision integrated circuits may be more susceptible to damage because very small parametric changes could cause the device not to meet its published specifications.

7.6 Glossary

[TI Glossary](#) This glossary lists and explains terms, acronyms, and definitions.

8 Revision History

DATE	REVISION	NOTES
March 2024	*	Initial Release

9 Mechanical, Packaging, and Orderable Information

The following pages include mechanical, packaging, and orderable information. This information is the most current data available for the designated devices. This data is subject to change without notice and revision of this document. For browser-based versions of this data sheet, refer to the left-hand navigation.

PACKAGING INFORMATION

Orderable Device	Status (1)	Package Type	Package Drawing	Pins	Package Qty	Eco Plan (2)	Lead finish/ Ball material (6)	MSL Peak Temp (3)	Op Temp (°C)	Device Marking (4/5)	Samples
ESDS452DBZR	ACTIVE	SOT-23	DBZ	3	3000	RoHS & Green	NIPDAU	Level-1-260C-UNLIM	-55 to 150	3BO8	Samples

(1) The marketing status values are defined as follows:

ACTIVE: Product device recommended for new designs.

LIFEBUY: TI has announced that the device will be discontinued, and a lifetime-buy period is in effect.

NRND: Not recommended for new designs. Device is in production to support existing customers, but TI does not recommend using this part in a new design.

PREVIEW: Device has been announced but is not in production. Samples may or may not be available.

OBSELETE: TI has discontinued the production of the device.

(2) **RoHS:** TI defines "RoHS" to mean semiconductor products that are compliant with the current EU RoHS requirements for all 10 RoHS substances, including the requirement that RoHS substance do not exceed 0.1% by weight in homogeneous materials. Where designed to be soldered at high temperatures, "RoHS" products are suitable for use in specified lead-free processes. TI may reference these types of products as "Pb-Free".

RoHS Exempt: TI defines "RoHS Exempt" to mean products that contain lead but are compliant with EU RoHS pursuant to a specific EU RoHS exemption.

Green: TI defines "Green" to mean the content of Chlorine (Cl) and Bromine (Br) based flame retardants meet JS709B low halogen requirements of <=1000ppm threshold. Antimony trioxide based flame retardants must also meet the <=1000ppm threshold requirement.

(3) MSL, Peak Temp. - The Moisture Sensitivity Level rating according to the JEDEC industry standard classifications, and peak solder temperature.

(4) There may be additional marking, which relates to the logo, the lot trace code information, or the environmental category on the device.

(5) Multiple Device Markings will be inside parentheses. Only one Device Marking contained in parentheses and separated by a "~" will appear on a device. If a line is indented then it is a continuation of the previous line and the two combined represent the entire Device Marking for that device.

(6) Lead finish/Ball material - Orderable Devices may have multiple material finish options. Finish options are separated by a vertical ruled line. Lead finish/Ball material values may wrap to two lines if the finish value exceeds the maximum column width.

Important Information and Disclaimer:The information provided on this page represents TI's knowledge and belief as of the date that it is provided. TI bases its knowledge and belief on information provided by third parties, and makes no representation or warranty as to the accuracy of such information. Efforts are underway to better integrate information from third parties. TI has taken and continues to take reasonable steps to provide representative and accurate information but may not have conducted destructive testing or chemical analysis on incoming materials and chemicals. TI and TI suppliers consider certain information to be proprietary, and thus CAS numbers and other limited information may not be available for release.

In no event shall TI's liability arising out of such information exceed the total purchase price of the TI part(s) at issue in this document sold by TI to Customer on an annual basis.

TAPE AND REEL INFORMATION

QUADRANT ASSIGNMENTS FOR PIN 1 ORIENTATION IN TAPE

*All dimensions are nominal

Device	Package Type	Package Drawing	Pins	SPQ	Reel Diameter (mm)	Reel Width W1 (mm)	A0 (mm)	B0 (mm)	K0 (mm)	P1 (mm)	W (mm)	Pin1 Quadrant
ESDS452DBZR	SOT-23	DBZ	3	3000	180.0	8.4	2.9	3.35	1.35	4.0	8.0	Q3

TAPE AND REEL BOX DIMENSIONS

*All dimensions are nominal

Device	Package Type	Package Drawing	Pins	SPQ	Length (mm)	Width (mm)	Height (mm)
ESDS452DBZR	SOT-23	DBZ	3	3000	210.0	185.0	35.0

EXAMPLE BOARD LAYOUT

DBZ0003A

SOT-23 - 1.12 mm max height

SMALL OUTLINE TRANSISTOR

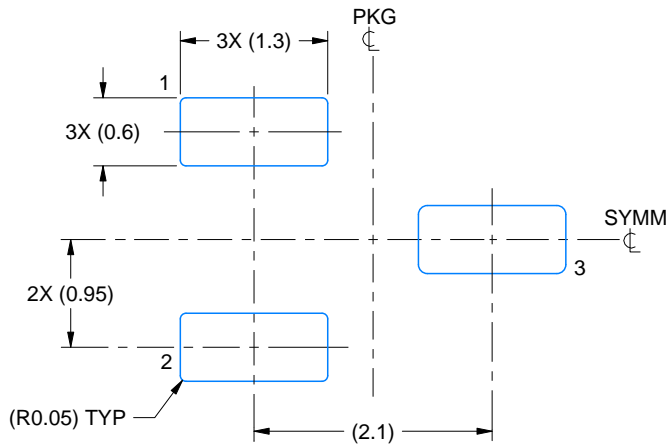

LAND PATTERN EXAMPLE
SCALE:15X

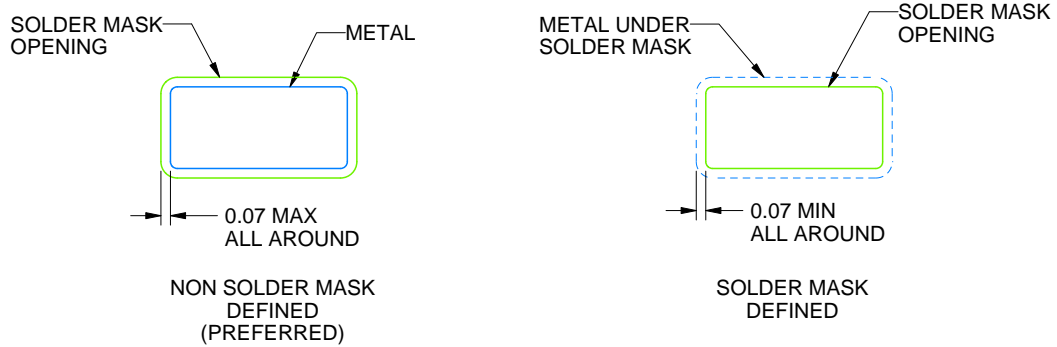

SOLDER MASK DETAILS

4214838/F 08/2024

NOTES: (continued)

- 5. Publication IPC-7351 may have alternate designs.
- 6. Solder mask tolerances between and around signal pads can vary based on board fabrication site.

EXAMPLE STENCIL DESIGN

DBZ0003A

SOT-23 - 1.12 mm max height

SMALL OUTLINE TRANSISTOR

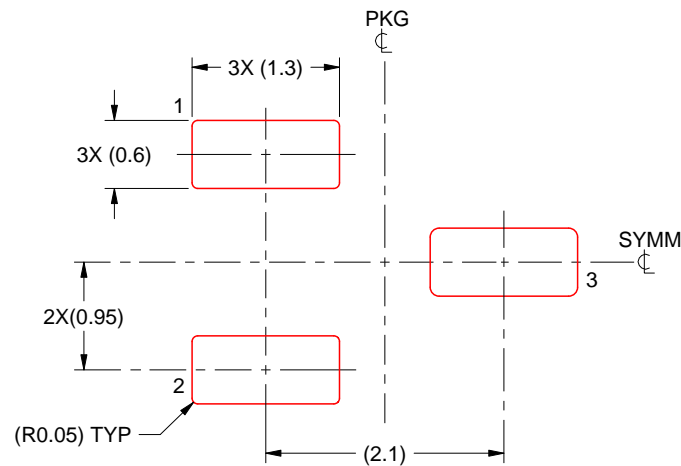

SOLDER PASTE EXAMPLE
BASED ON 0.125 THICK STENCIL
SCALE:15X

4214838/F 08/2024

NOTES: (continued)

7. Laser cutting apertures with trapezoidal walls and rounded corners may offer better paste release. IPC-7525 may have alternate design recommendations.
8. Board assembly site may have different recommendations for stencil design.

IMPORTANT NOTICE AND DISCLAIMER

TI PROVIDES TECHNICAL AND RELIABILITY DATA (INCLUDING DATA SHEETS), DESIGN RESOURCES (INCLUDING REFERENCE DESIGNS), APPLICATION OR OTHER DESIGN ADVICE, WEB TOOLS, SAFETY INFORMATION, AND OTHER RESOURCES "AS IS" AND WITH ALL FAULTS, AND DISCLAIMS ALL WARRANTIES, EXPRESS AND IMPLIED, INCLUDING WITHOUT LIMITATION ANY IMPLIED WARRANTIES OF MERCHANTABILITY, FITNESS FOR A PARTICULAR PURPOSE OR NON-INFRINGEMENT OF THIRD PARTY INTELLECTUAL PROPERTY RIGHTS.

These resources are intended for skilled developers designing with TI products. You are solely responsible for (1) selecting the appropriate TI products for your application, (2) designing, validating and testing your application, and (3) ensuring your application meets applicable standards, and any other safety, security, regulatory or other requirements.

These resources are subject to change without notice. TI grants you permission to use these resources only for development of an application that uses the TI products described in the resource. Other reproduction and display of these resources is prohibited. No license is granted to any other TI intellectual property right or to any third party intellectual property right. TI disclaims responsibility for, and you will fully indemnify TI and its representatives against, any claims, damages, costs, losses, and liabilities arising out of your use of these resources.

TI's products are provided subject to [TI's Terms of Sale](#) or other applicable terms available either on [ti.com](https://www.ti.com) or provided in conjunction with such TI products. TI's provision of these resources does not expand or otherwise alter TI's applicable warranties or warranty disclaimers for TI products.

TI objects to and rejects any additional or different terms you may have proposed.

Mailing Address: Texas Instruments, Post Office Box 655303, Dallas, Texas 75265
Copyright © 2024, Texas Instruments Incorporated