

Part No. 1002232

ISM & WLAN FR4 Embedded Antenna

868 MHz, 915 MHz, 2.4 GHz

Supports: Wi-Fi, WLAN applications, Bluetooth, LoRa

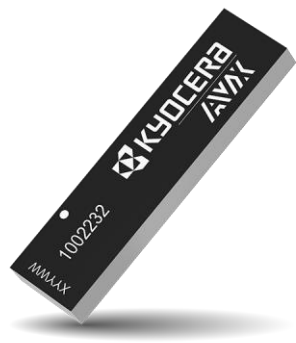

KYOCERA AVX 1002232 FR4 antenna delivers the device designers' key needs for higher functionality and performance in smaller/thinner designs. This innovative antenna provides compelling advantages for all ISM and WLAN enabled devices.

Unique Form Factors Support Advanced Industrial Designs

Smaller, more efficient on-board embedded antennas break through restrictive design rules and provide new freedom in component placement.

ISM & WLAN FR4 Embedded Antenna

863 - 928 MHz
2400 – 2500 MHz

KEY BENEFITS

Versatile Antenna

1002232 can be used to support ISM and WLAN combined, allowing reduced BOM complexity while maintaining great performances.

Quicker Time-to-Market

By optimizing antenna size, performance and emissions, customer and regulatory specifications are more easily met.

Environmental Compliance

Products are the latest RoHS version compliant.

APPLICATIONS

- Embedded design
- Cellular, Headsets, Tablets
- Gateway, Access Point
- SRD868
- Telematics
- Tracking
- M2M, Industrial devices
- Smart Grid
- OBD-II

Electrical Specifications

Typical performance on 110 x 50 mm PCB in free space.

Frequency	ISM EU 863 - 870 MHz	ISM US 902 - 928 MHz	WLAN 2400 - 2500 MHz
Peak Gain	0.51 dBi	0.21 dBi	1.5 dBi
Average Efficiency	63%	60%	59%
VSWR Match	2.0:1 max		
Feed Point Impedance	50 ohms unbalanced		
Polarization	Linear		
Power Handling	2 Watt CW		

Mechanical Specifications & Ordering Part Number

Ordering Part Number	1002232
Size (mm)	35.0 x 9.0 x 3.2
Weight (grams)	2.0
Mounting	SMT (P&P)
Demo Board	1002232-01
Notes/ Remarks	Black
Additional Resources	Download DXF, Gerber and 3D FIT Files

ISM / WLAN FR4 KYOCERA AVX Antenna Specifications
 KYOCERA AVX produces a wide variety of standard and custom antennas to meet user needs.

Antenna Dimensions (1002232)

Typical antenna dimensions (mm)

Part Number	A (mm)	B (mm)	C (mm)
1002232	35.0 ± 0.3	9.0 ± 0.2	3.2 ± 0.3



Top view



Front view

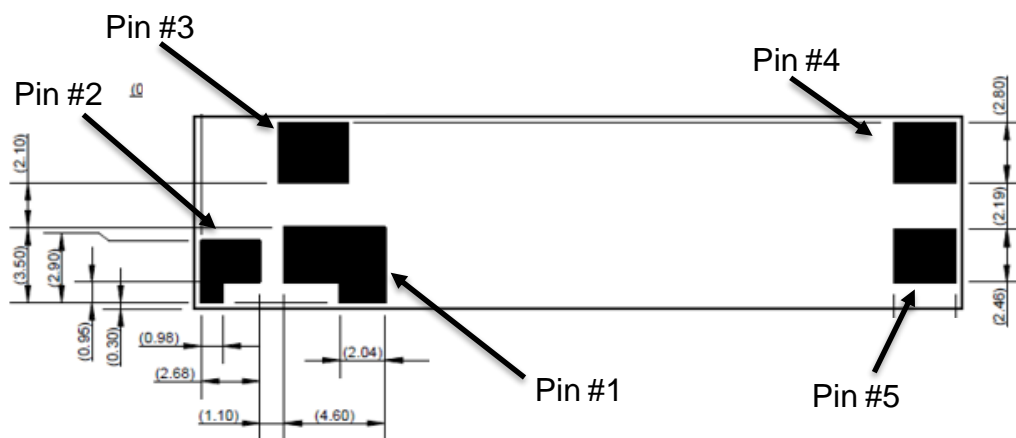

Bottom view

Pin#	Description
1	Feed
2	Ground
3	Dummy Pad
4	Dummy Pad
5	Dummy Pad

ISM / WLAN FR4 KYOCERA AVX Antenna Specifications
 KYOCERA AVX produces a wide variety of standard and custom antennas to meet user needs.

VSWR and Efficiency Plots

Typical performance on 110 x 50 mm PCB

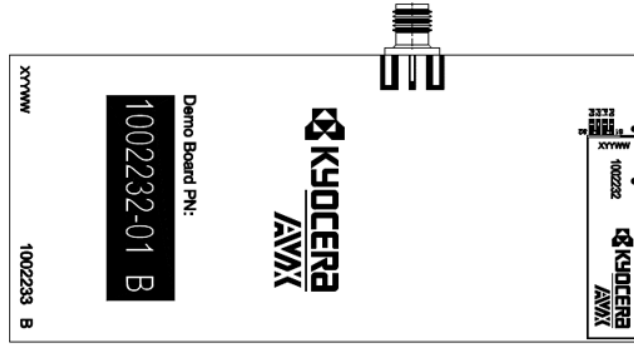

ISM VSWR

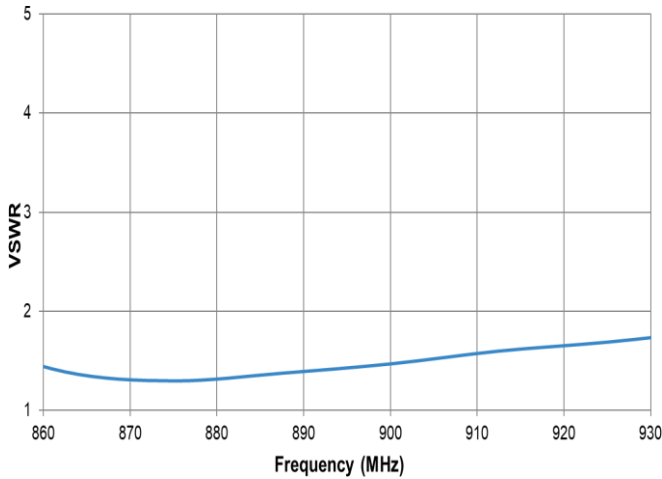

WLAN VSWR

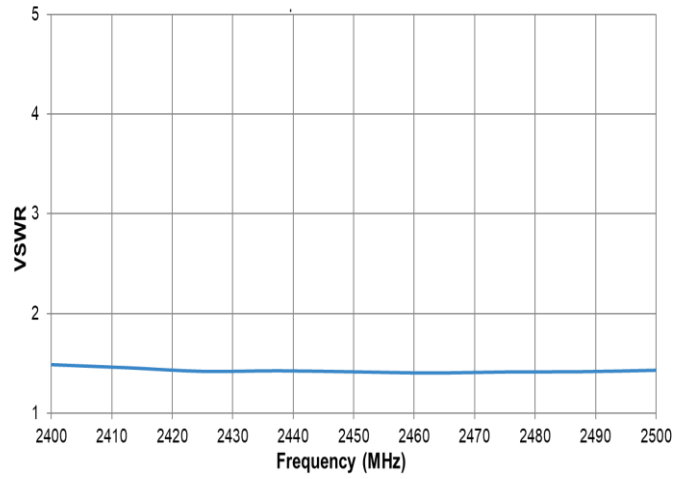

ISM Efficiency

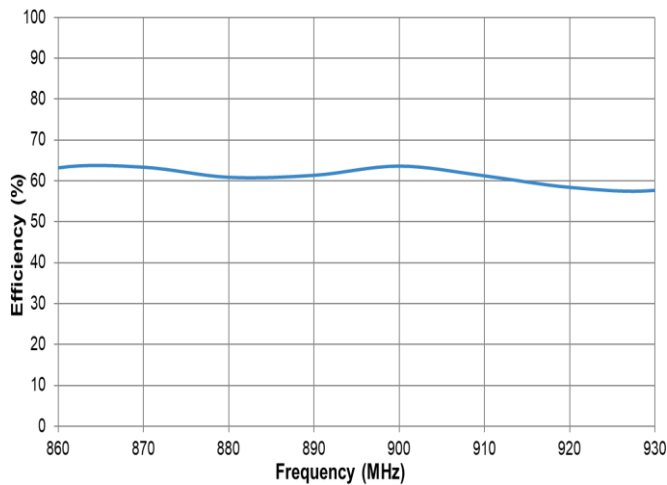

WLAN Efficiency

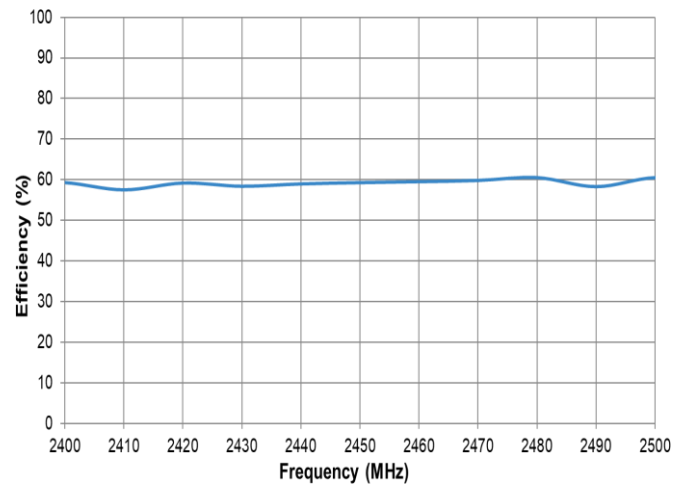

ISM / WLAN FR4 KYOCERA AVX Antenna Specifications
 KYOCERA AVX produces a wide variety of standard and custom antennas to meet user needs.

Antenna Radiation Patterns

Typical performance on 110 x 50 mm PCB
 Measured @ 868, 900, 2400 MHz

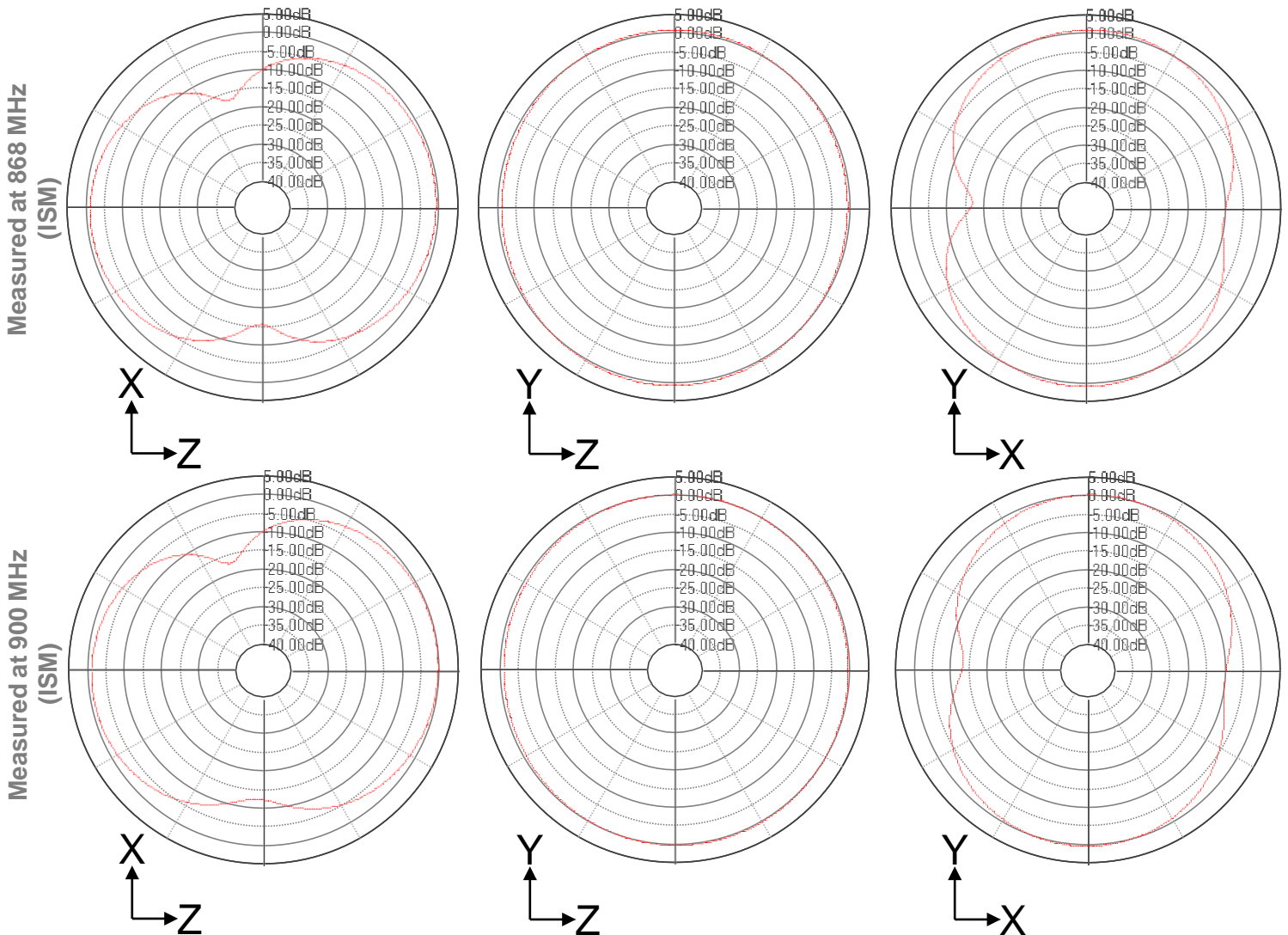
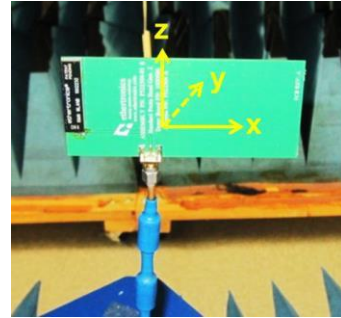
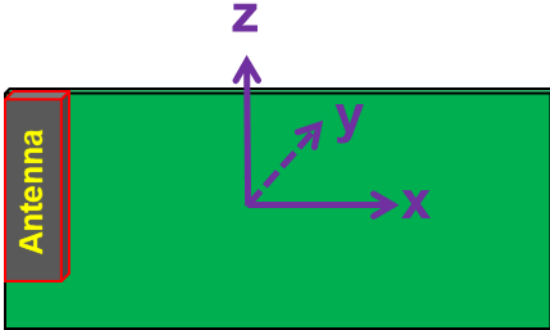

ISM / WLAN FR4 KYOCERA AVX Antenna Specifications
 KYOCERA AVX produces a wide variety of standard and custom antennas to meet user needs.

Antenna Radiation Patterns

Typical performance on 110 x 50 mm PCB
 Measured @ 868, 900, 2400 MHz

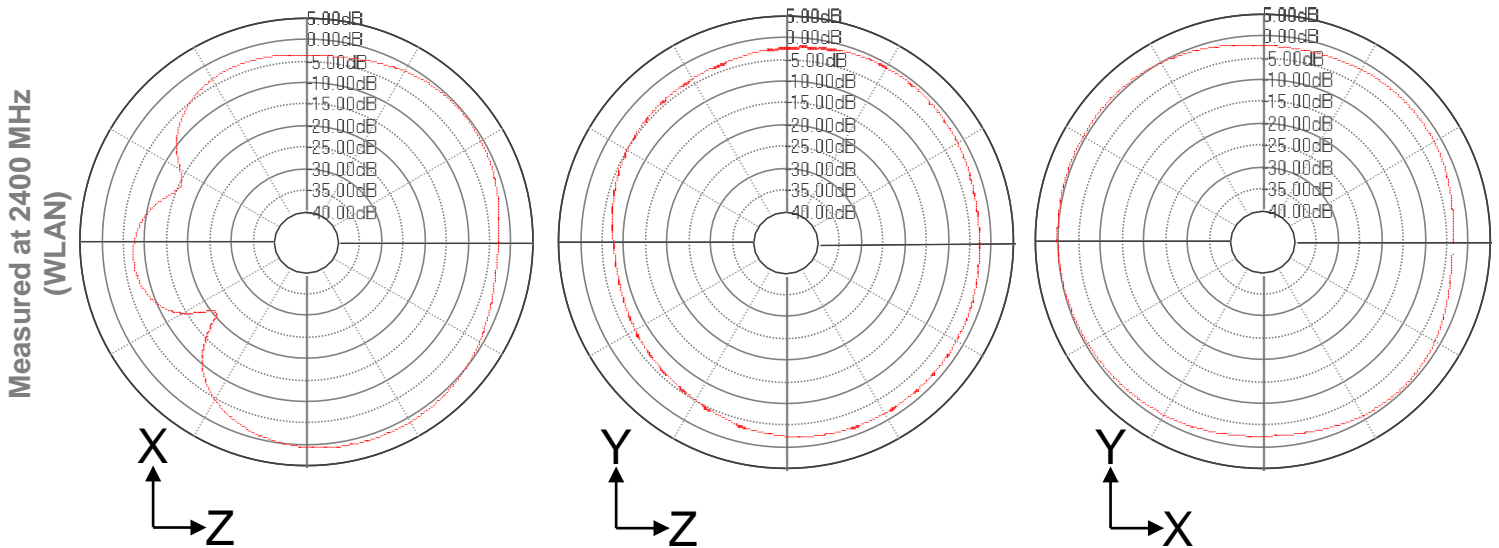
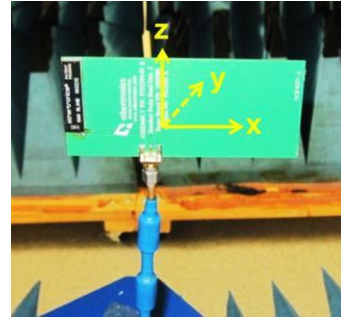
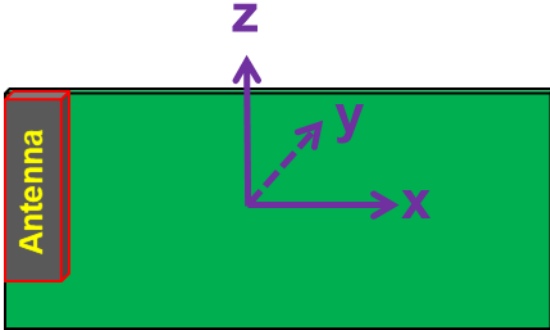

ISM / WLAN FR4 KYOCERA AVX Antenna Specifications
 KYOCERA AVX produces a wide variety of standard and custom antennas to meet user needs.

Antenna Layout

Typical layout dimensions (mm)

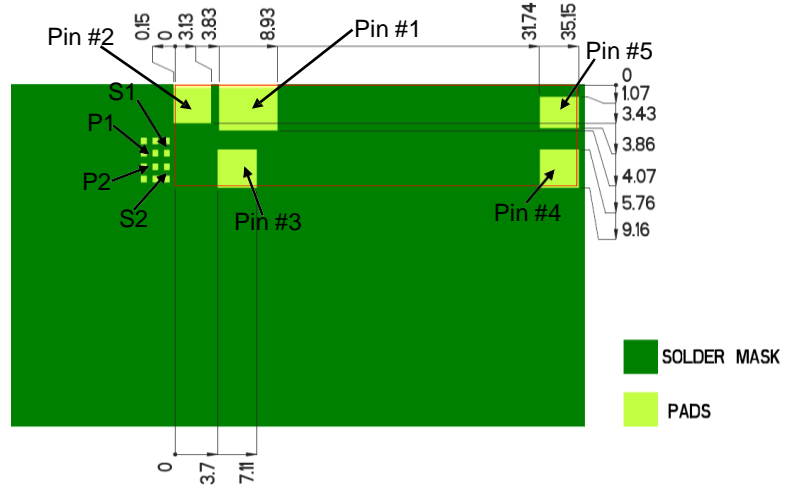
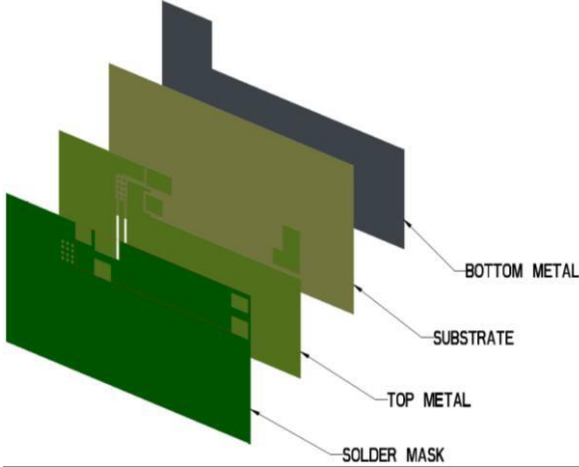

* VIAS: Diam. 0.2mm, (no vias on transmission lines).
 Via holes must be covered by solder mask

Pin Descriptions

Pin#	Description
1	Feed
2	Ground
3	Dummy Pad
4	Dummy Pad
5	Dummy Pad

Matching & Tuning Component Values

Component	Value	Tolerance
S1	2.0pF	±0.05pF
P1	N/A	N/A
P2	0.5pF	±0.05pF
S2	3.3nH	±0.1nH

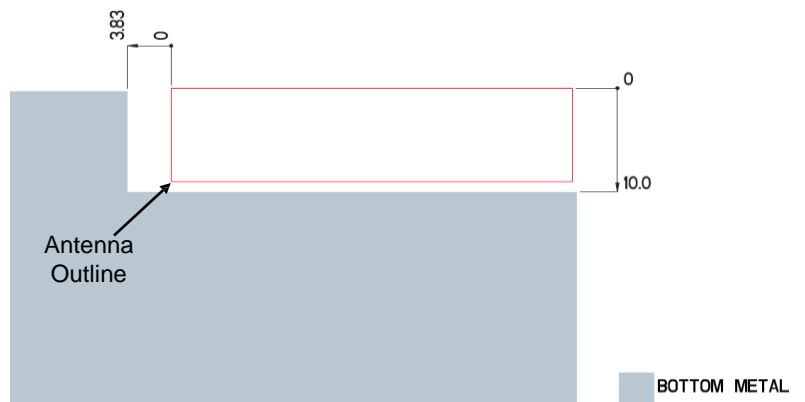
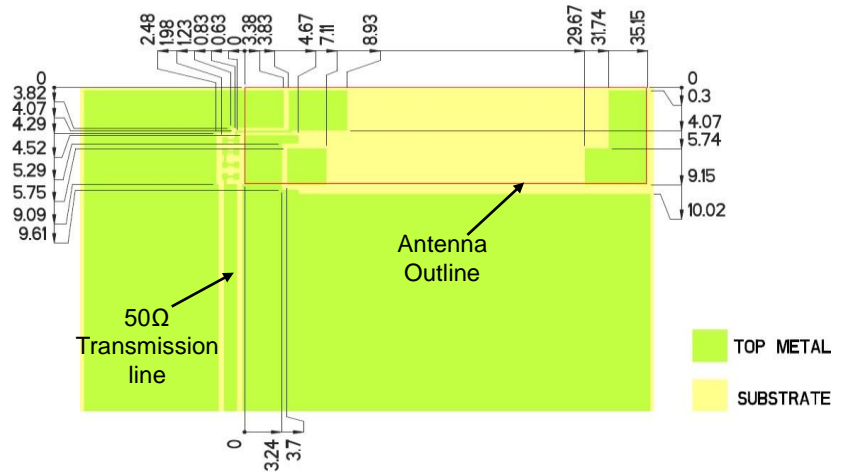

ISM / WLAN FR4 KYOCERA AVX Antenna Specifications
KYOCERA AVX produces a wide variety of standard and custom antennas to meet user needs.

Antenna Matching Structure

Typical matching values on 50 x 110 mm PCB

Demo Board Front View

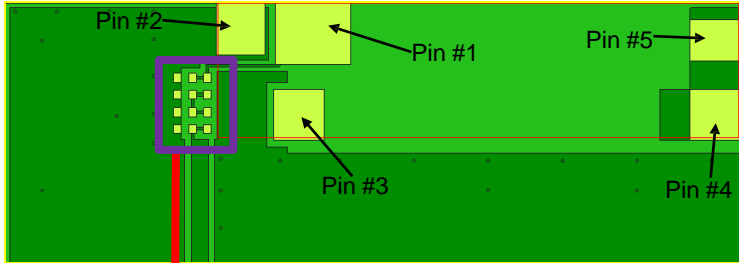

Antenna Matching

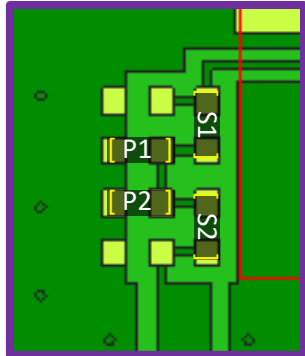

(Antenna Matching):
pads are directly inline with the antenna feed trace.



Pin Descriptions

Pin#	Description
1	Feed
2	Ground
3	Dummy Pad
4	Dummy Pad
5	Dummy Pad

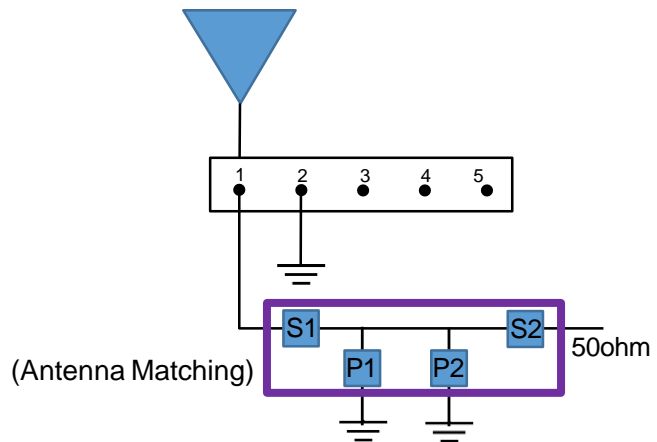

	S1	P1	P2	S2
Default Matching	2.0pF	N/A	0.5pF	3.3nH
Tolerance	±0.05pF	N/A	±0.05pF	± 0.1nH

ISM / WLAN FR4 KYOCERA AVX Antenna Specifications
 KYOCERA AVX produces a wide variety of standard and custom antennas to meet user needs.

Antenna Demo Board (1002232)

Demo Board Front view (mm)

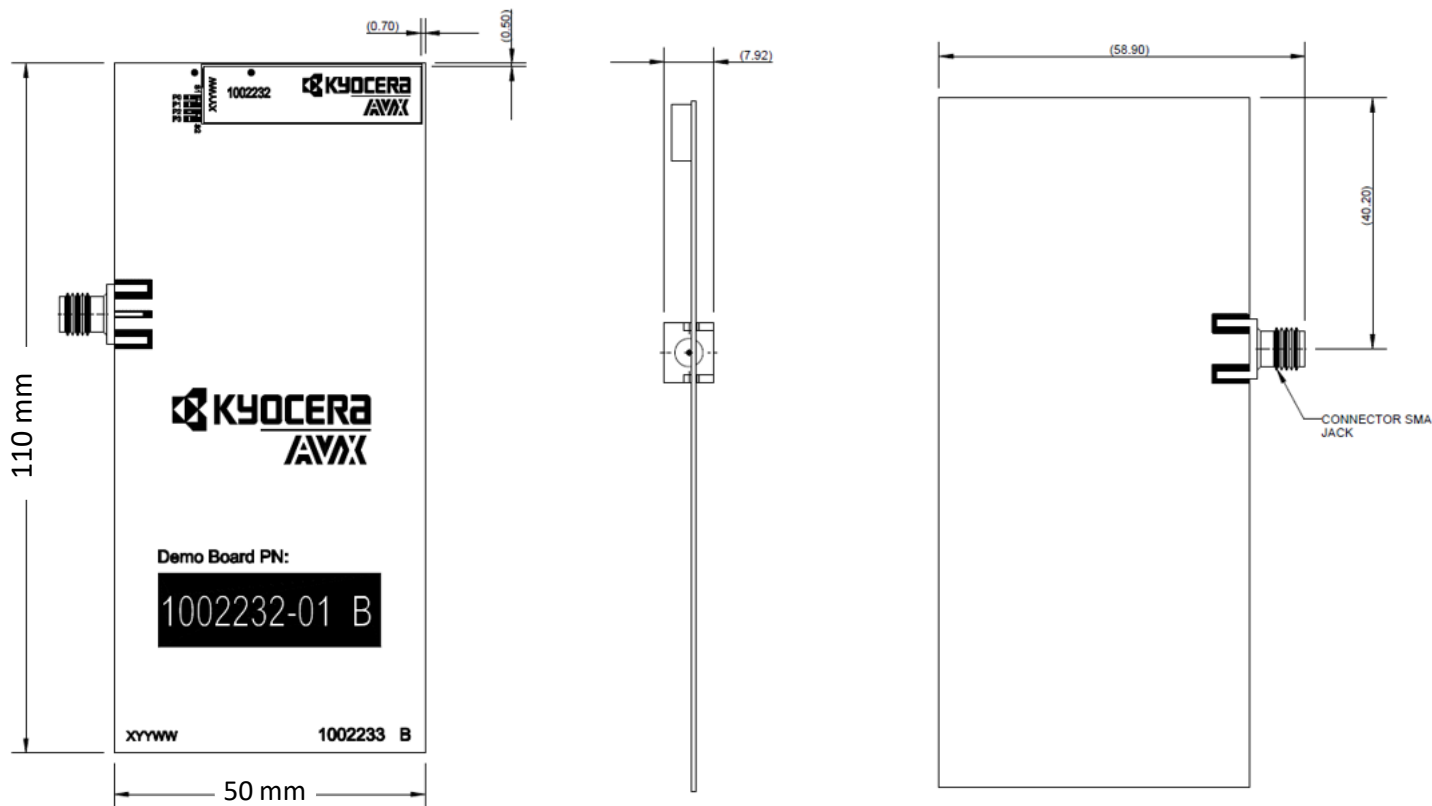

Top view

Front view

Bottom view

ISM / WLAN FR4 KYOCERA AVX Antenna Specifications
KYOCERA AVX produces a wide variety of standard and custom antennas to meet user needs.

Additional Resources – 1002232

3D FIT File:

https://www.kyocera-avx.com/download/antennas/ME-FIT/1002232_ME_fit.zip

DXF File:

https://www.kyocera-avx.com/download/antennas/3D-DXF/1002232_3D-DXF.zip

Gerber File:

https://www.kyocera-avx.com/download/antennas/GERBER/1002232_GERBERS.zip