

**-100V P-Channel Enhancement Mode MOSFET**

**Description**

The IRFR9120NTR uses advanced trench technology and design to provide excellent  $R_{DS(ON)}$  with low gate charge. It can be used in a wide variety of applications.

It is ESD protected.

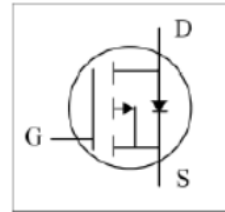

**General Features**

$V_{DS} = -100V, I_D = -8A$

$R_{DS(ON)} < 210m @ V_{GS} = -10V$  (Typ:145m )

Super high dense cell design

Advanced trench process technology

Reliable and rugged

High density cell design for ultra low on-resistance

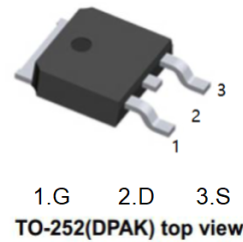

**Application**

Power switch

DC/DC converters

**Absolute Maximum Ratings ( $T_c = 25^\circ C$  unless otherwise noted)**

Parameter	Symbol	Limit	Unit
Drain-Source Voltage	$V_{DS}$	-100	V
Gate-Source Voltage	$V_{GS}$	$\pm 20$	V
Drain Current-Continuous	$I_D$	-8	A
Drain Current-Continuous( $T_c = 100^\circ C$ )	$I_D(100^\circ C)$	-6	A
Pulsed Drain Current	$I_{DM}$	-30	A
Maximum Power Dissipation	$P_D$	40	W
Derating factor		0.32	W/ $^\circ C$
Single pulse avalanche energy (Note 5)	$E_{AS}$	110	mJ
Operating Junction and Storage Temperature Range	$T_J, T_{STG}$	-55 To 150	$^\circ C$

## -100V P-Channel Enhancement Mode MOSFET

### Thermal Characteristic

Thermal Resistance, Junction-to-Case (Note 2)	$R_{\theta jc}$	3.13	$^{\circ}C/W$
---	-----------------	------	---------------

### Electrical Characteristics ( $T_c=25^{\circ}C$ unless otherwise noted)

Parameter	Symbol	Condition	Min	Typ	Max	Unit
Drain-Source Breakdown Voltage	$BV_{DSS}$	$V_{GS}=0V, I_D=-250\mu A$	-100			V
Zero Gate Voltage Drain Current	$I_{DSS}$	$V_{DS}=-100V, V_{GS}=0V$			1	$\mu A$
Gate-Body Leakage Current	$I_{GSS}$	$V_{GS}=\pm 20V, V_{DS}=0V$			$\pm 10$	$\mu A$
Gate Threshold Voltage	$V_{GS(th)}$	$V_{DS}=V_{GS}, I_D=-250\mu A$	-1		-3	V
Drain-Source On-State Resistance	$R_{DS(on)}$	$V_{GS}=-10V, I_D=-16A$		210	235	$m\Omega$
Forward Transconductance	$g_{FS}$	$V_{DS}=-15V, I_D=-5A$	12	-		S
Input Capacitance	$C_{iss}$	$V_{DS}=-25V, V_{GS}=0V,$ $F=1.0MHz$		760		PF
Output Capacitance	$C_{oss}$			260		PF
Reverse Transfer Capacitance	$C_{rss}$			170		PF
Turn-on Delay Time	$t_{d(on)}$	$V_{DD}=-50V, I_D=-10A$ $V_{GS}=-10V, R_{GEN}=9.1$		14		nS
Turn-on Rise Time	$t_r$			18		nS
Turn-Off Delay Time	$t_{d(off)}$			50		nS
Turn-Off Fall Time	$t_f$			18		nS
Total Gate Charge	$Q_g$	$V_{DS}=-50V, I_D=-10A,$ $V_{GS}=-10V$		25		nC
Gate-Source Charge	$Q_{gs}$			5		nC
Gate-Drain Charge	$Q_{gd}$			7		nC
Diode Forward Voltage (Note 3)	$V_{SD}$	$V_{GS}=0V, I_S=-10A$			-1.2	V
Diode Forward Current (Note 2)	$I_S$	-			-13	A
Reverse Recovery Time	$t_{rr}$	$T_J = 25^{\circ}C, I_F = -10A$ $di/dt = 100A/\mu s$ (Note 3)		35		nS
Reverse Recovery Charge	$Q_{rr}$			46		nC
Forward Turn-On Time	$t_{on}$	Intrinsic turn-on time is negligible (turn-on is dominated by LS+LD)				

### Notes:

1. Repetitive Rating: Pulse width limited by maximum junction temperature.
2. Surface Mounted on FR4 Board,  $t \leq 10$  sec.
3. Pulse Test: Pulse Width  $\leq 300\mu s$ , Duty Cycle  $\leq 2\%$ .
4. Guaranteed by design, not subject to production
5.  $E_{AS}$  condition:  $T_J=25^{\circ}C, V_{DD}=-50V, V_G=-10V, L=0.5mH, R_g=25$

Typical Electrical and Thermal Characteristics (Curves)

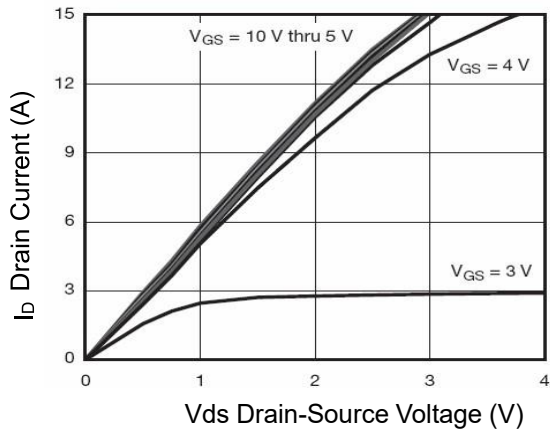

Figure 1 Output Characteristics

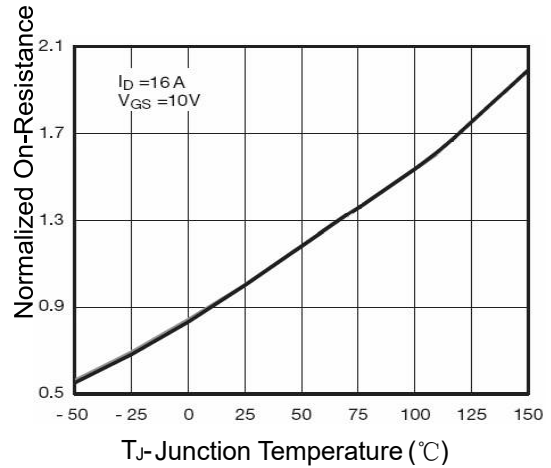

Figure 4 Rdson-Junction Temperature

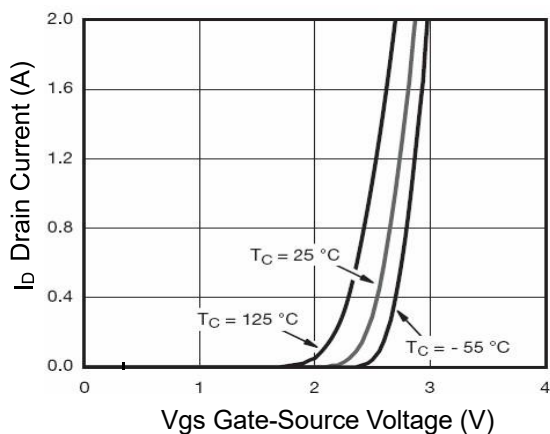

Figure 2 Transfer Characteristics

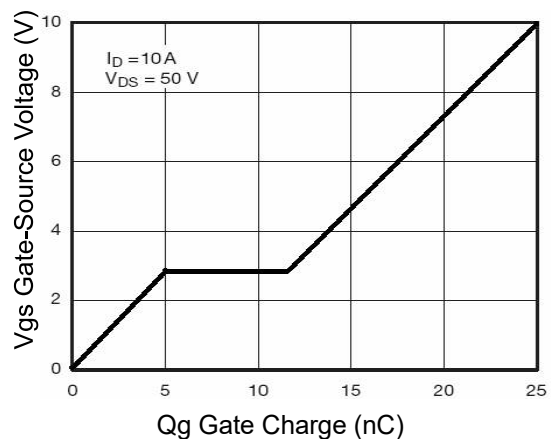

Figure 5 Gate Charge

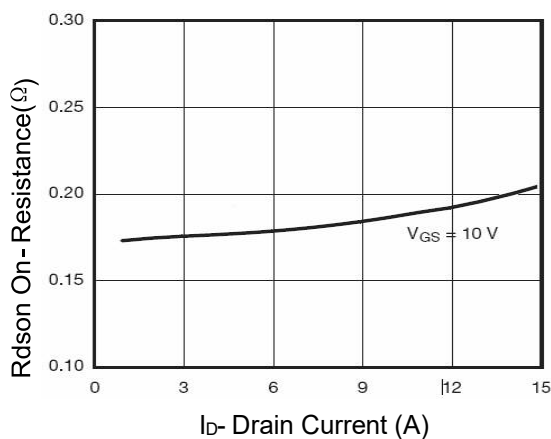

Figure 3 Rdson- Drain Current

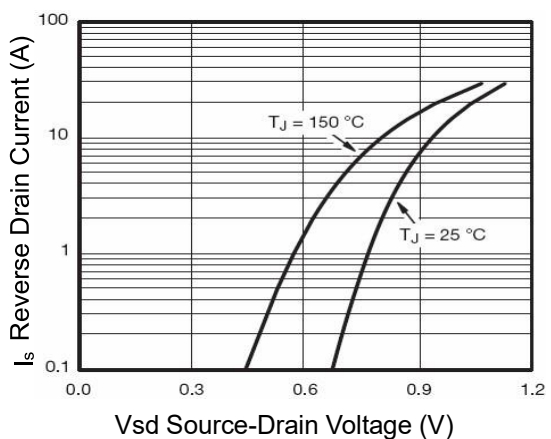

Figure 6 Source- Drain Diode Forward

-100V P-Channel Enhancement Mode MOSFET

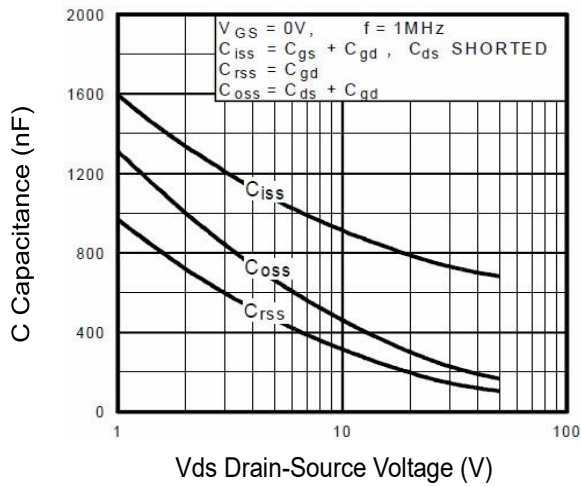

Figure 7 Capacitance vs Vds

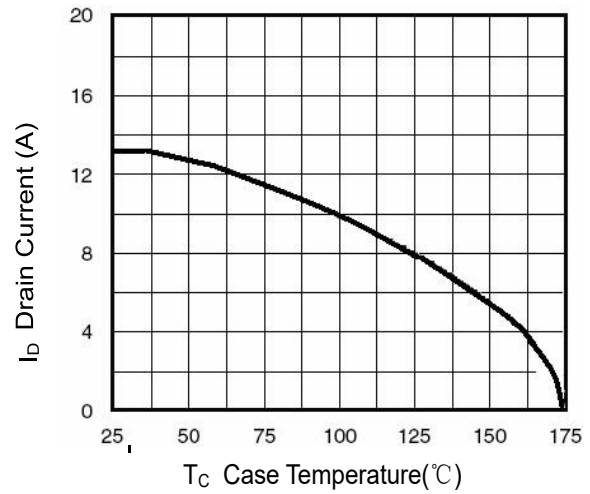

Figure 9 Drain Current vs Case Temperature

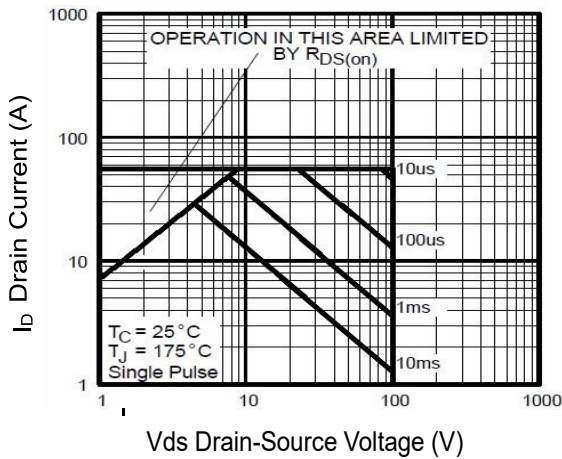

Figure 8 Safe Operation Area

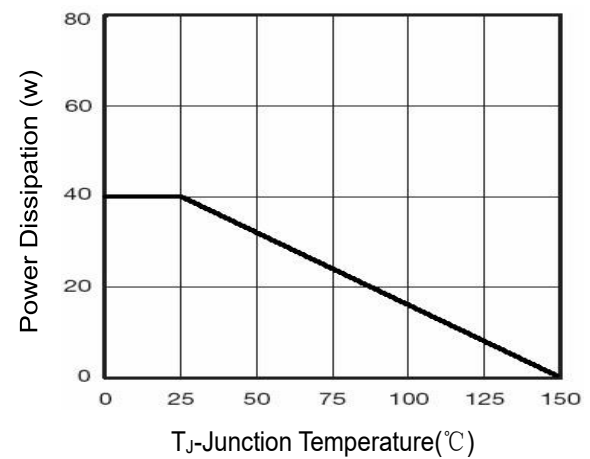

Figure 10 Power De-rating

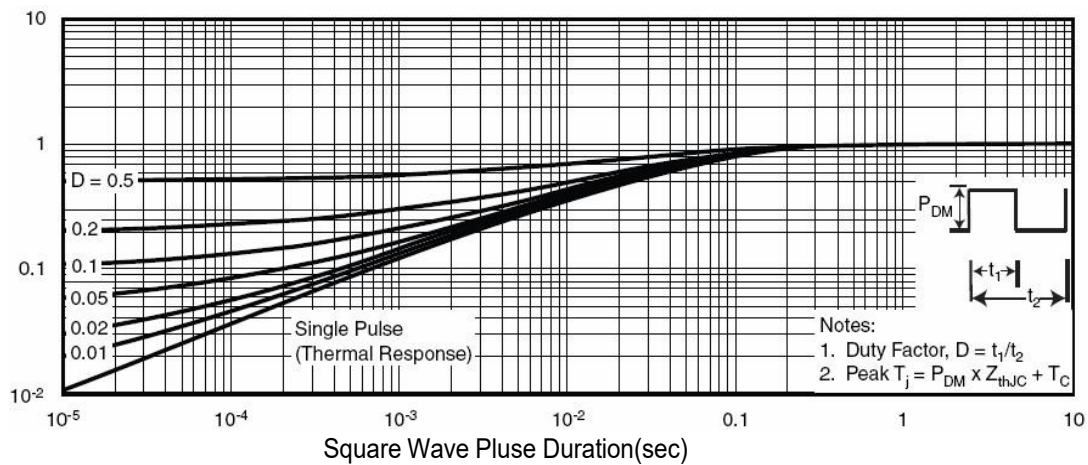
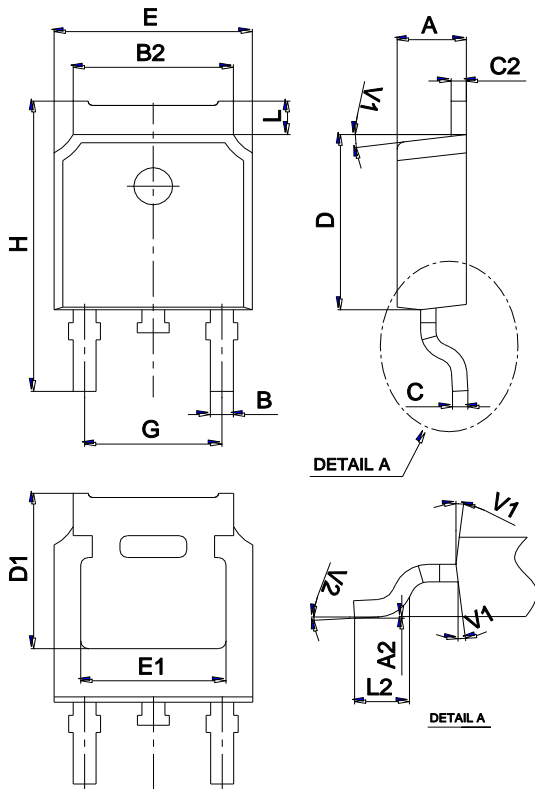

Figure 11 Normalized Maximum Transient Thermal

Package Mechanical Data TO-252



Ref.	Dimensions					
	Millimeters			Inches		
	Min.	Typ.	Max.	Min.	Typ.	Max.
A	2.10		2.50	0.083		0.098
A2	0		0.10	0		0.004
B	0.66		0.86	0.026		0.034
B2	5.18		5.48	0.202		0.216
C	0.40		0.60	0.016		0.024
C2	0.44		0.58	0.017		0.023
D	5.90		6.30	0.232		0.248
D1	5.30REF			0.209REF		
E	6.40		6.80	0.252		0.268
E1	4.63			0.182		
G	4.47		4.67	0.176		0.184
H	9.50		10.70	0.374		0.421
L	1.09		1.21	0.043		0.048
L2	1.35		1.65	0.053		0.065
V1		7°			7°	
V2	0°		6°	0°		6°

Marking

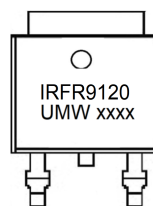

Ordering information

Order code	Package	Baseqty	Deliverymode
UMW IRFR9120NTR	TO-252	2500	Tape and reel