



Sliver for SFF-TA-1002

TE Internal #: 2324305-2

Sliver Cable Assembly, 124 Position, 1 m, 16 Gb/s, Discrete Pair, 33 AWG, Sliver Plug, Sliver Plug, High Speed, 124 Signal Positions, CL2

[View on TE.com >](#)

Cable Assemblies > Copper Cable Assemblies > Internal I/O Cable Assemblies

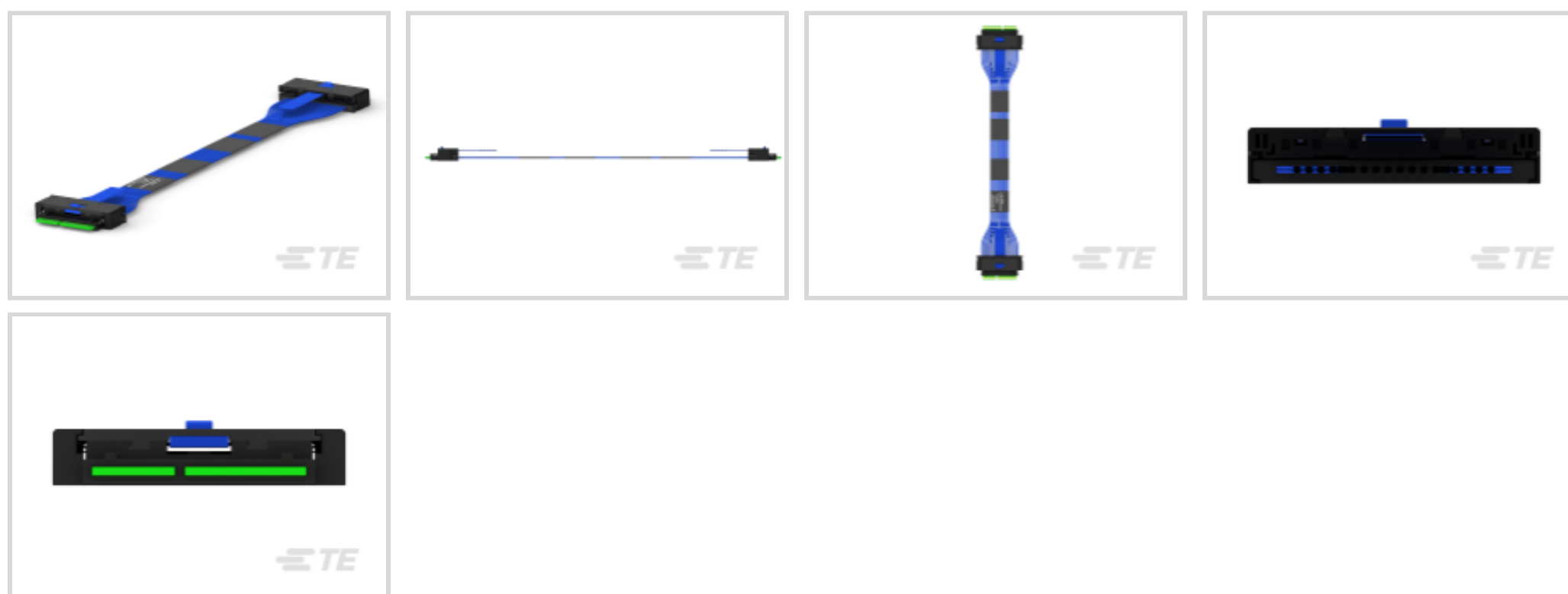

Cable Assembly Type: **Sliver**

Cable Assembly (End A): **Sliver Plug**

Cable Assembly (End B): **Sliver Plug**

Cable Style: **Discrete Pair**

Cable Assembly Category: **High Speed**

Features

Product Type Features

| | |
|-------------------------|---------------|
| Cable Assembly Type | Sliver |
| Cable Assembly (End A) | Sliver Plug |
| Cable Assembly (End B) | Sliver Plug |
| Cable Style | Discrete Pair |
| Cable Assembly Category | High Speed |

Configuration Features

| | |
|----------------------------|-----|
| Number of Positions | 124 |
| Number of Signal Positions | 124 |

Electrical Characteristics

| | |
|-----------|------|
| Impedance | 85 Ω |
|-----------|------|

Signal Characteristics

| | |
|-----------|---------|
| Data Rate | 16 Gb/s |
|-----------|---------|

Body Features

| | |
|---------------------------|-----|
| Cable Flammability Rating | CL2 |
|---------------------------|-----|



Dimensions

| | |
|-----------|--------|
| Wire Size | 33 AWG |
|-----------|--------|

Operation/Application

| | |
|--------------|----|
| Halogen Free | No |
|--------------|----|

Other

| | |
|------------------------------|--------------|
| Cable Assembly Configuration | Double Ended |
| Cable Assembly Length | 1 m |

Product Compliance

[For compliance documentation, visit the product page on TE.com>](#)

| | |
|---|---|
| EU RoHS Directive 2011/65/EU | Compliant |
| EU ELV Directive 2000/53/EC | Compliant |
| China RoHS 2 Directive MIIT Order No 32, 2016 | No Restricted Materials Above Threshold |
| EU REACH Regulation (EC) No. 1907/2006 | Current ECHA Candidate List: JUNE 2024 (241) Candidate List Declared Against: JUNE 2024 (241) Does not contain REACH SVHC |
| Halogen Content | Not Low Halogen - contains Br or Cl > 900 ppm. |
| Solder Process Capability | Not reviewed for solder process capability |

Product Compliance Disclaimer

This information is provided based on reasonable inquiry of our suppliers and represents our current actual knowledge based on the information they provided. This information is subject to change. The part numbers that TE has identified as EU RoHS compliant have a maximum concentration of 0.1% by weight in homogenous materials for lead, hexavalent chromium, mercury, PBB, PBDE, DBP, BBP, DEHP, DIBP, and 0.01% for cadmium, or qualify for an exemption to these limits as defined in the Annexes of Directive 2011/65/EU (RoHS2). Finished electrical and electronic equipment products will be CE marked as required by Directive 2011/65/EU. Components may not be CE marked. Additionally, the part numbers that TE has identified as EU ELV compliant have a maximum concentration of 0.1% by weight in homogenous materials for lead, hexavalent chromium, and mercury, and 0.01% for cadmium, or qualify for an exemption to these limits as defined in the Annexes of Directive 2000/53/EC (ELV). Regarding the REACH Regulation, the information TE provides on SVHC in articles for this part number is based on the latest European Chemicals Agency (ECHA) 'Guidance on requirements for substances in articles' posted at this URL: <https://echa.europa.eu/guidance-documents/guidance-on-reach>

Also in the Series | [Sliver for SFF-TA-1002](#)



Connector Hardware(1)

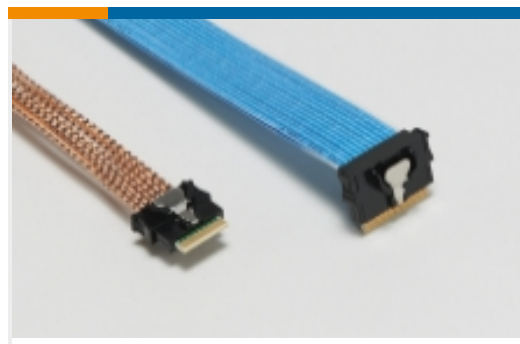

Internal I/O Cable Assemblies(105)



Internal I/O Connectors(133)

Customers Also Bought



TE Part #1-440129-4
2.0MM,HSG,14POS

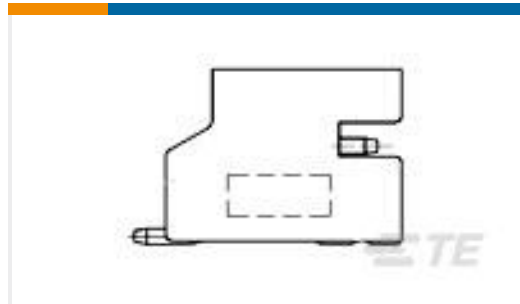

TE Part #1-1775469-4
HPI CONN., 2.0MM, R/A, SMT, 14P, 80U"

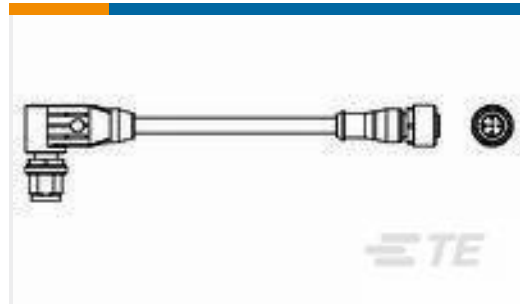

TE Part #1-2273121-5
M12 angled plug to M12 strgt socket AA



TE Part #2821385-1
SLIVER C/A, 74P, R/A TO R/A, 10GHZ, 85OHM



TE Part #2292069-1
RCPT ASSEMBLY SMT RA 74 POSN MBC

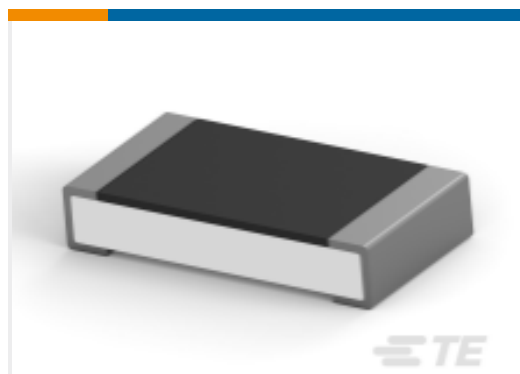

TE Part #4-2176388-0
RQ 1206 25R5 0.1% 10PPM 5K RL

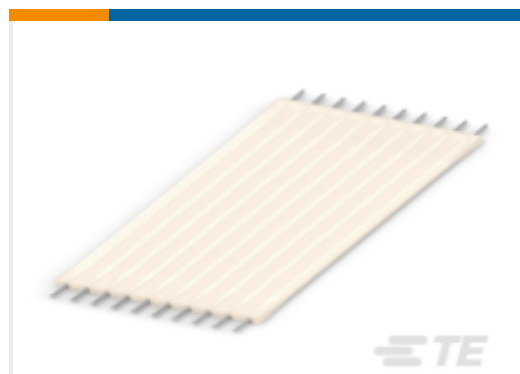

TE Part #2-6437158-6
FSN-12A

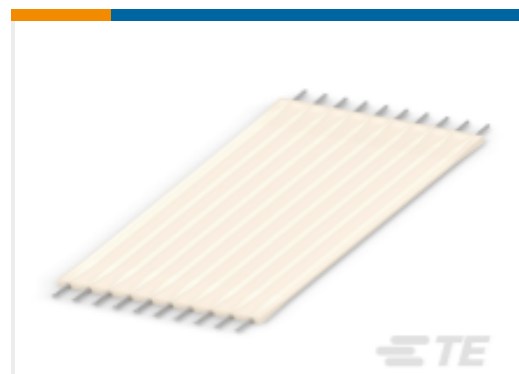

TE Part #1-6437158-3
FSN-11.5A



TE Part #7-2176269-0
RU 0603 15K 0.01% 2PPM 1K RL



TE Part #4-1879132-0
RN 0402 23K2 0.1% 10PPM 1K RL

Documents

Product Drawings

C/A, SLIVER 124P, STR TO STR

English

CAD Files

3D PDF

3D

Customer View Model

ENG_CVM_CVM_2339107-1_A.2d_dxf.zip



English

Customer View Model

[ENG_CVM_CVM_2339107-1_A.3d_igs.zip](#)

English

Customer View Model

[ENG_CVM_CVM_2339107-1_A.3d_stp.zip](#)

English

By downloading the CAD file I accept and agree to the [Terms and Conditions](#) of use.

Datasheets & Catalog Pages

[Sliver Internal Cabled Interconnect Solutions Brochure \(Chinese\)](#)

Product Specifications

Product Specification

English

Product Specification

English