

# DRV8601 Haptic Driver for DC Motors (ERMs) and Linear Vibrators (LRAs) With Ultra-Fast Turnon

## 1 Features

- High Current Output: 400 mA
- Wide Supply Voltage Range (2.5 V to 5.5 V) for Direct Battery Operation
- Low Quiescent Current: 1.7 mA (Typical)
- Fast Startup Time: 100  $\mu$ s
- Low Shutdown Current: 10 nA
- Output Short-Circuit Protection
- Thermal Protection
- Enable Pin is 1.8-V Compatible
- Available in a 3-mm x 3-mm VQFN Package (DRB) and 2-mm x 2-mm MicroStar Junior™ PBGA Package (ZQV)

## 2 Applications

- Mobile Phones
- Tablets
- Portable Gaming Consoles
- Portable Navigation Devices
- Appliance Consoles

## 3 Description

The DRV8601 is a single-supply haptic driver that is optimized to drive a DC motor (also known as Eccentric Rotating Mass or ERM in haptics terminology) or a linear vibrator (also known as Linear Resonant Actuator or LRA in haptics terminology) using a single-ended PWM input signal. With a fast turn-on time of 100  $\mu$ s, the DRV8601 is an excellent haptic driver for use in mobile phones and other portable electronic devices.

The DRV8601 drives up to 400 mA from a 3.3-V supply. Near rail-to-rail output swing under load ensures sufficient voltage drive for most DC motors. Differential output drive allows the polarity of the voltage across the output to be reversed quickly, thereby enabling motor speed control in both clockwise and counter-clockwise directions, allowing quick motor stopping. A wide input voltage range allows precise speed control of both DC motors and linear vibrators.

With a typical quiescent current of 1.7 mA and a shutdown current of 10 nA, the DRV8601 is ideal for portable applications. The DRV8601 has thermal and output short-circuit protection to prevent the device from being damaged during fault conditions.

### Device Information<sup>(1)</sup>

PART NUMBER	PACKAGE	BODY SIZE (NOM)
DRV8601	DRB (8)	3.00 mm x 3.00 mm
	ZQV (8)	2.00 mm x 2.00 mm

(1) For all available packages, see the orderable addendum at the end of the datasheet.

### Block Diagram

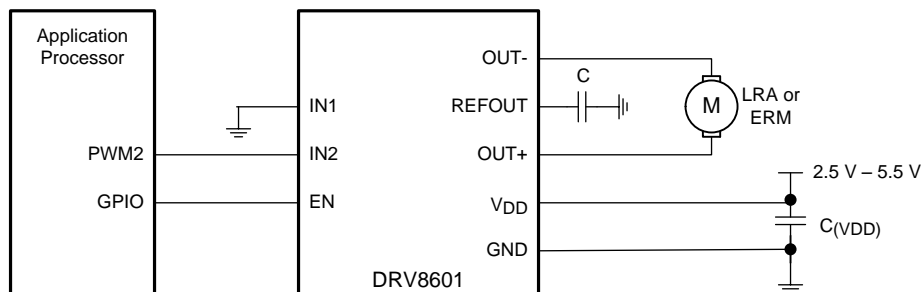

Copyright © 2016, Texas Instruments Incorporated



## Table of Contents

<b>1 Features</b> .....	1	7.3 Feature Description.....	8
<b>2 Applications</b> .....	1	7.4 Device Functional Modes.....	9
<b>3 Description</b> .....	1	<b>8 Application and Implementation</b> .....	10
<b>4 Revision History</b> .....	2	8.1 Application Information.....	10
<b>5 Pin Configuration and Functions</b> .....	3	8.2 Typical Applications .....	11
<b>6 Specifications</b> .....	4	<b>9 Power Supply Recommendations</b> .....	15
6.1 Absolute Maximum Ratings .....	4	<b>10 Layout</b> .....	16
6.2 ESD Ratings .....	4	10.1 Layout Guidelines .....	16
6.3 Recommended Operating Conditions.....	4	10.2 Layout Example .....	16
6.4 Thermal Information .....	4	<b>11 Device and Documentation Support</b> .....	17
6.5 Electrical Characteristics.....	5	11.1 Receiving Notification of Documentation Updates	17
6.6 Operating Characteristics.....	5	11.2 Community Resources.....	17
6.7 Typical Characteristics.....	5	11.3 Trademarks .....	17
<b>7 Detailed Description</b> .....	8	11.4 Electrostatic Discharge Caution.....	17
7.1 Overview .....	8	11.5 Glossary .....	17
7.2 Functional Block Diagram .....	8	<b>12 Mechanical, Packaging, and Orderable Information</b> .....	17

## 4 Revision History

NOTE: Page numbers for previous revisions may differ from page numbers in the current version.

Changes from Revision C (January 2016) to Revision D	Page
• Added the ZQV package to the <i>Features</i> list and the <i>Device Information</i> table .....	1
• Added the ZQV pinout to the <i>Pin Configuration and Functions</i> section.....	3
• Added ZQV values to the <i>Thermal Information</i> table .....	4
• Added <a href="#">Figure 20</a> .....	16

Changes from Revision B (January 2012) to Revision C	Page
• Added <i>ESD Rating</i> table, <i>Feature Description</i> section, <i>Device Functional Modes</i> section, <i>Application and Implementation</i> section, <i>Power Supply Recommendations</i> section, <i>Layout</i> section, <i>Device and Documentation Support</i> section, and <i>Mechanical, Packaging, and Orderable Information</i> section .....	1

Changes from Revision A (May 2011) to Revision B	Page
• Changed R <sub>1</sub> value from 49.9 kΩ to 100 kΩ in Conditions statement in <i>Typical Characteristics</i> .....	5

Changes from Original (July 2010) to Revision A	Page
• Added the DRB package to the <i>Features</i> list .....	1
• Updated <i>Application Information</i> section .....	11
• Added polarity to motor in application diagrams in <a href="#">Figure 16</a> , <a href="#">Figure 17</a> , and <a href="#">Figure 18</a> .....	11

## 5 Pin Configuration and Functions

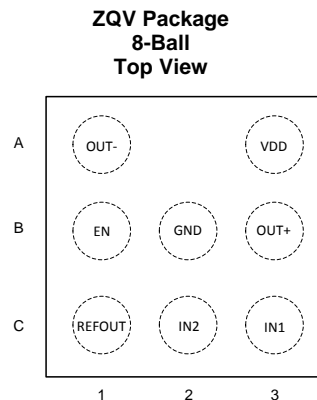
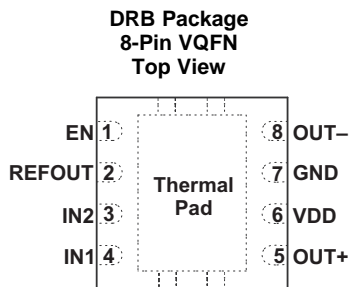

### Pin Functions

NAME	PIN		TYPE <sup>(1)</sup>	DESCRIPTION
	DRB NO.	ZQV NO.		
EN	1	B1	I	Chip enable
GND	7	B2	P	Ground
IN1	4	C3	I	Input to driver
IN2	3	C2	I	Input to driver
OUT+	5	B3	O	Positive output
OUT-	8	A1	O	Negative output
REFOUT	2	C1	O	Reference voltage output
VDD	6	A3	P	Supply voltage

(1) I = Input, O = Output, P = Power

## 6 Specifications

### 6.1 Absolute Maximum Ratings

over operating free-air temperature range,  $T_A \leq 25^\circ\text{C}$  (unless otherwise noted)<sup>(1)</sup>

		MIN	MAX	UNIT
$V_{DD}$	Supply voltage	-0.3	6	V
$V_I$	Input voltage, INx, EN	-0.3	$V_{DD} + 0.3$	V
	Output continuous total power dissipation	See <a href="#">Thermal Information</a>		
$T_A$	Operating free-air temperature	-40	85	$^\circ\text{C}$
$T_J$	Operating junction temperature	-40	150	$^\circ\text{C}$
$T_{stg}$	Storage temperature	-65	150	$^\circ\text{C}$

- (1) Stresses beyond those listed under *Absolute Maximum Ratings* may cause permanent damage to the device. These are stress ratings only, which do not imply functional operation of the device at these or any other conditions beyond those indicated under *Recommended Operating Conditions*. Exposure to absolute-maximum-rated conditions for extended periods may affect device reliability.

### 6.2 ESD Ratings

			VALUE	UNIT
$V_{(ESD)}$	Electrostatic discharge	Human-body model (HBM), per ANSI/ESDA/JEDEC JS-001 <sup>(1)</sup>	$\pm 4000$	V
		Charged-device model (CDM), per JEDEC specification JESD22-C101 <sup>(2)</sup>	$\pm 1500$	

- (1) JEDEC document JEP155 states that 500-V HBM allows safe manufacturing with a standard ESD control process.

- (2) JEDEC document JEP157 states that 250-V CDM allows safe manufacturing with a standard ESD control process.

### 6.3 Recommended Operating Conditions

		MIN	NOM	MAX	UNIT
$V_{DD}$	Supply voltage		2.5	5.5	V
$V_{IH}$	High-level input voltage	EN	1.15		V
$V_{IL}$	Low-level input voltage	EN		0.5	V
$T_A$	Operating free-air temperature	-40		85	$^\circ\text{C}$
$Z_L$	Load impedance		6.4		$\Omega$

### 6.4 Thermal Information

THERMAL METRIC <sup>(1)</sup>	DRV8601		UNIT	
	DRB	ZQV		
	8 PINS	8 BALLS		
$R_{\theta JA}$	Junction-to-ambient thermal resistance	52.8	78	$^\circ\text{C}/\text{W}$
$R_{\theta JC(top)}$	Junction-to-case (top) thermal resistance	63	155	$^\circ\text{C}/\text{W}$
$R_{\theta JB}$	Junction-to-board thermal resistance	28.4	65	$^\circ\text{C}/\text{W}$
$\Psi_{JT}$	Junction-to-top characterization parameter	2.7	5	$^\circ\text{C}/\text{W}$
$\Psi_{JB}$	Junction-to-board characterization parameter	28.6	50	$^\circ\text{C}/\text{W}$
$R_{\theta JC(bot)}$	Junction-to-case (bottom) thermal resistance	11.4	n/a	$^\circ\text{C}/\text{W}$

- (1) For more information about traditional and new thermal metrics, see the [Semiconductor and IC Package Thermal Metrics](#) application report.

## 6.5 Electrical Characteristics

at  $T_A = 25^\circ\text{C}$ , Gain = 2 V/V,  $R_L = 10\ \Omega$  (unless otherwise noted)

PARAMETER		TEST CONDITIONS	MIN	TYP	MAX	UNIT
$ V_{OO} $	Output offset voltage (measured differentially)	$V_I = 0\ \text{V}$ , $V_{DD} = 2.5\ \text{V}$ to $5.5\ \text{V}$			9	mV
$V_{OD,N}$	Negative differential output voltage ( $V_{OUT+} - V_{OUT-}$ )	$V_{IN+} = V_{DD}$ , $V_{IN-} = 0\ \text{V}$ or $V_{IN+} = 0\ \text{V}$ , $V_{IN-} = V_{DD}$	$V_{DD} = 5.0\ \text{V}$ , $I_o = 400\ \text{mA}$	-4.55		V
			$V_{DD} = 3.3\ \text{V}$ , $I_o = 300\ \text{mA}$	-2.87		
			$V_{DD} = 2.5\ \text{V}$ , $I_o = 200\ \text{mA}$	-2.15		
$V_{OD,P}$	Positive differential output voltage ( $V_{OUT+} - V_{OUT-}$ )	$V_{IN+} = V_{DD}$ , $V_{IN-} = 0\ \text{V}$ or $V_{IN+} = 0\ \text{V}$ , $V_{IN-} = V_{DD}$	$V_{DD} = 5.0\ \text{V}$ , $I_o = 400\ \text{mA}$	4.55		V
			$V_{DD} = 3.3\ \text{V}$ , $I_o = 300\ \text{mA}$	2.87		
			$V_{DD} = 2.5\ \text{V}$ , $I_o = 200\ \text{mA}$	2.15		
$ I_{IH} $	High-level EN input current	$V_{DD} = 5.5\ \text{V}$ , $V_I = 5.8\ \text{V}$			1.2	$\mu\text{A}$
$ I_{IL} $	Low-level EN input current	$V_{DD} = 5.5\ \text{V}$ , $V_I = -0.3\ \text{V}$			1.2	$\mu\text{A}$
$I_{DD(Q)}$	Supply current	$V_{DD} = 2.5\ \text{V}$ to $5.5\ \text{V}$ , No load, EN = $V_{IH}$		1.7	2	mA
$I_{DD(SD)}$	Supply current in shutdown mode	EN = $V_{IL}$ , $V_{DD} = 2.5\ \text{V}$ to $5.5\ \text{V}$ , No load		0.01	0.9	$\mu\text{A}$

## 6.6 Operating Characteristics

at  $T_A = 25^\circ\text{C}$ , Gain = 2 V/V,  $R_L = 10\ \Omega$  (unless otherwise noted)

PARAMETER		TEST CONDITIONS	MIN	TYP	MAX	UNIT
$Z_I$	Input impedance			2		$\text{M}\Omega$
$Z_O$	Output impedance	Shutdown mode (EN = $V_{IL}$ )	>10			$\text{k}\Omega$

## 6.7 Typical Characteristics

**Table 1. Table of Graphs**

		FIGURE
Output voltage (High)	vs Load current	<a href="#">Figure 1</a>
Output voltage (Low)	vs Load current	<a href="#">Figure 2</a>
Output voltage	vs Input voltage, $R_L = 10\ \Omega$	<a href="#">Figure 3</a>
Output voltage	vs Input voltage, $R_L = 20\ \Omega$	<a href="#">Figure 4</a>
Supply current	vs Supply voltage	<a href="#">Figure 5</a>
Shutdown supply current	vs Supply voltage	<a href="#">Figure 6</a>
Power dissipation	vs Supply voltage	<a href="#">Figure 7</a>
Slew rate	vs Supply voltage	<a href="#">Figure 8</a>
Output transition	vs Time	<a href="#">Figure 9</a> , <a href="#">Figure 10</a>
Startup	vs Time	<a href="#">Figure 11</a>
Shutdown	vs Time	<a href="#">Figure 12</a>

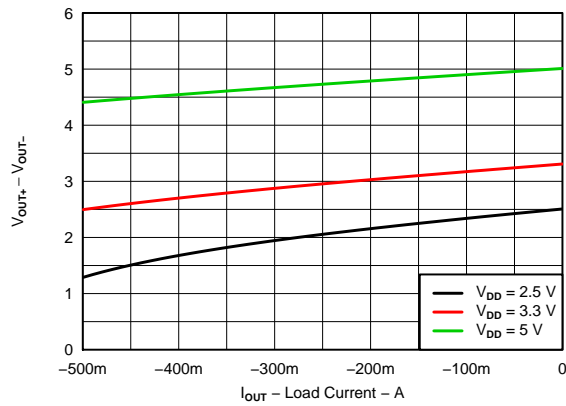

Figure 1. Output Voltage (High) vs Load Current

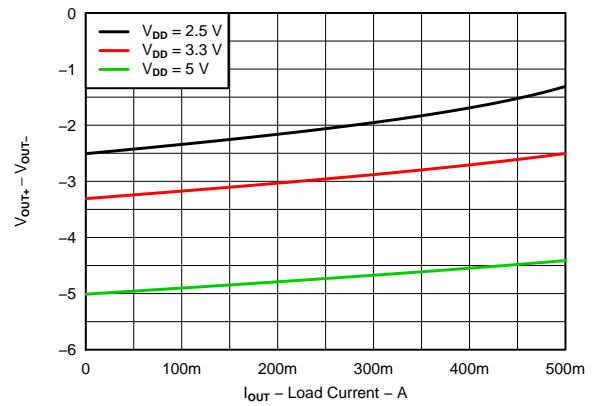

Figure 2. Output Voltage (Low) vs Load Current

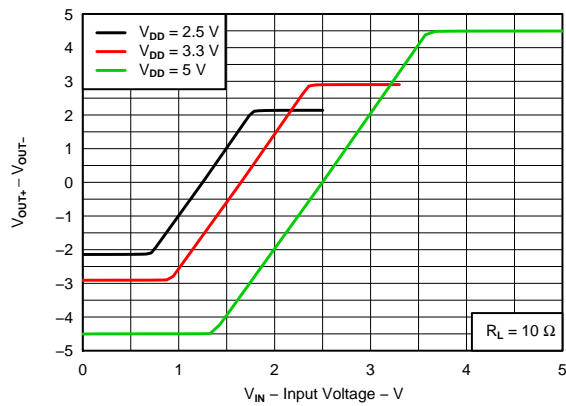

Figure 3. Output Voltage vs Input Voltage

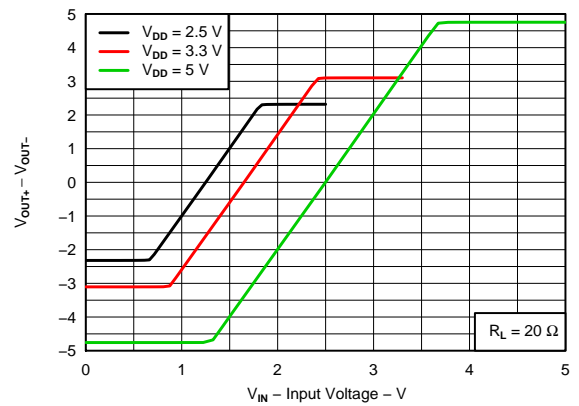

Figure 4. Output Voltage vs Input Voltage

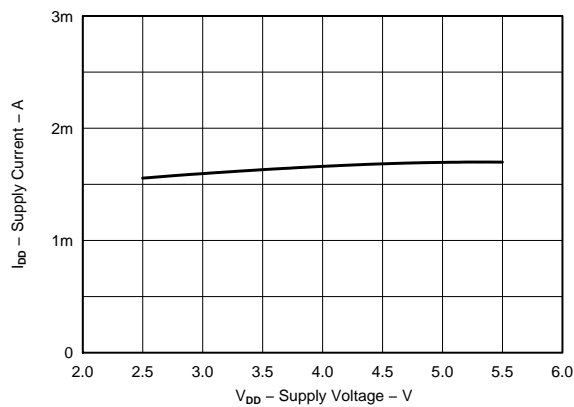

Figure 5. Supply Current vs Supply Voltage

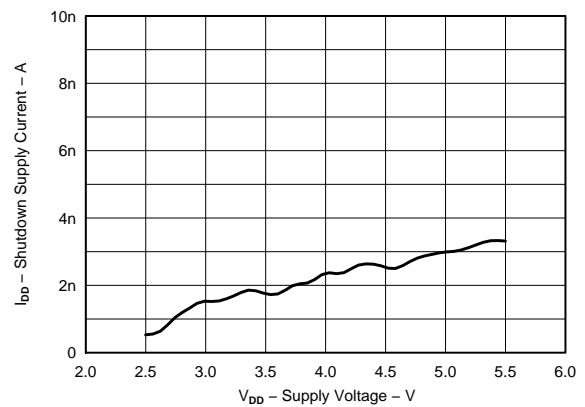

Figure 6. Shutdown Supply Current vs Supply Voltage

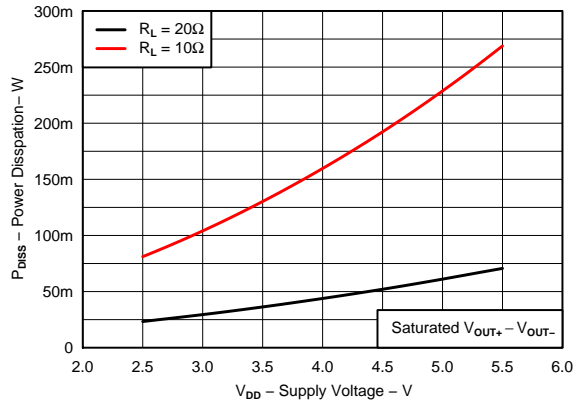

Figure 7. Power Dissipation vs Supply Voltage

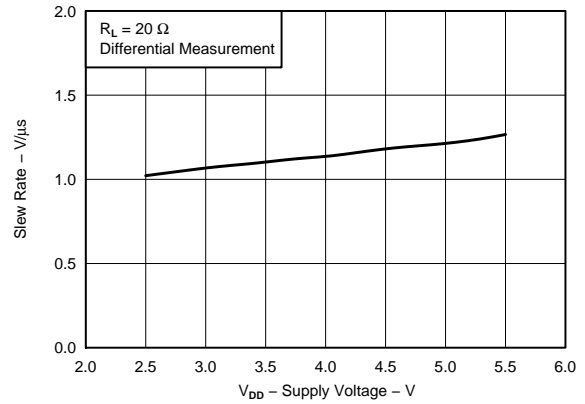

Figure 8. Slew Rate vs Supply Voltage

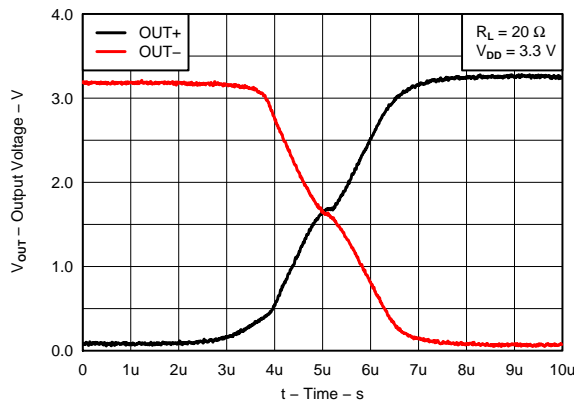

Figure 9. Output Transition vs Time

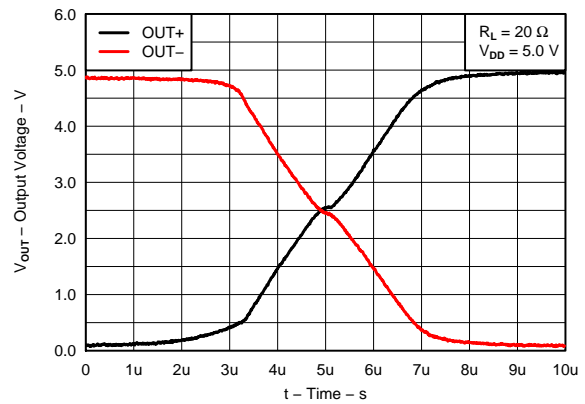

Figure 10. Output Transition vs Time

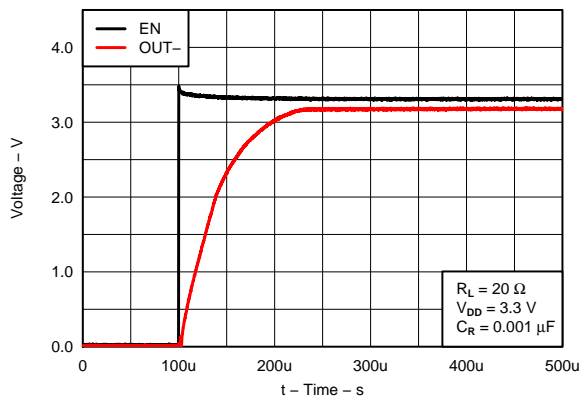

Figure 11. Startup vs Time

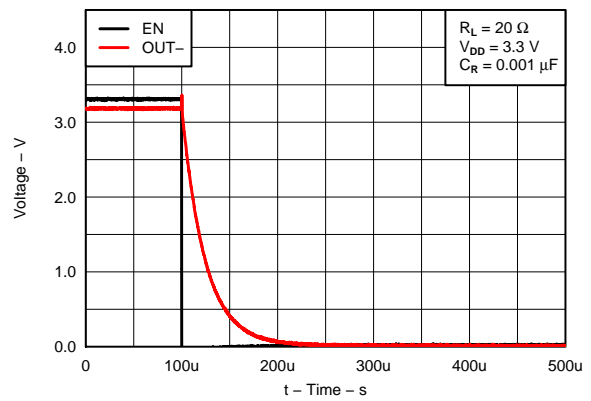

Figure 12. Shutdown vs Time

## 7 Detailed Description

### 7.1 Overview

DRV8601 is a single-supply haptic driver that is optimized to drive ERM or LRAs. DRV8601 can drive in both clockwise and counter-clockwise directions, as well as stop the motor quickly. This is possible due to the fact that outputs are driven differentially and are capable of driving or sinking current. DRV8601 also eliminates long vibration tails which are undesirable in haptic feedback systems.

The DRV8601 can accept a single-ended PWM source or single-ended DC control voltage and perform single-ended to differential conversion. A PWM signal is typically generated using software, and many different advanced haptic sensations can be produced by inputting different types of PWM signals into the DRV8601.

### 7.2 Functional Block Diagram

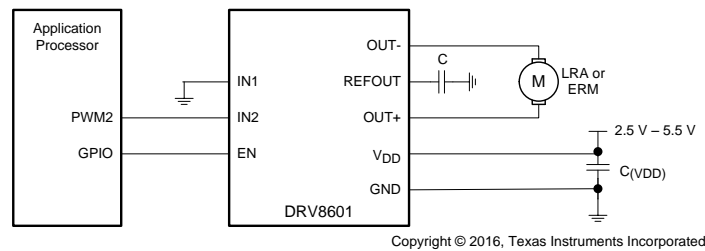

### 7.3 Feature Description

#### 7.3.1 Support for ERM and LRA Actuators

Linear vibrators (also known as Linear Resonant Actuators or LRA in haptics terminology) vibrate only at their resonant frequency. Usually, linear vibrators have a high-Q frequency response, due to which there is a rapid drop in vibration performance at offsets of 3 to 5 Hz from the resonant frequency. Therefore, while driving a linear vibrator with the DRV8601, ensure that the commutation of the input PWM signal is within the prescribed frequency range for the chosen linear vibrator. Vary the duty cycle of the PWM signal symmetrically above and below 50% to vary the strength of the vibration. As in the case of DC motors, the PWM signal is typically generated using software, and many different advanced haptic sensations can be produced by applying different PWM signals into the DRV8601.

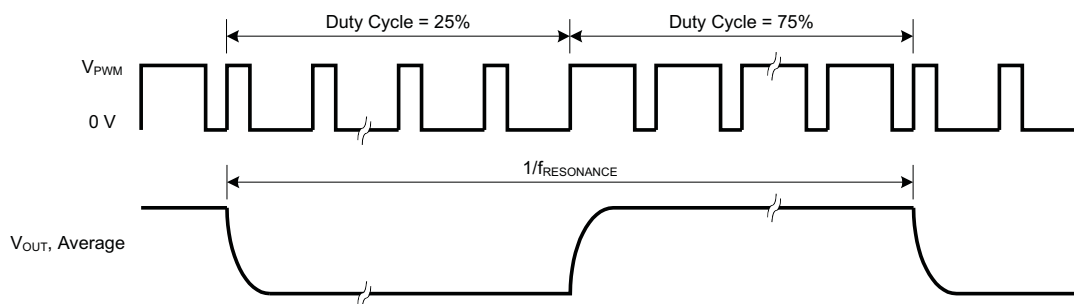
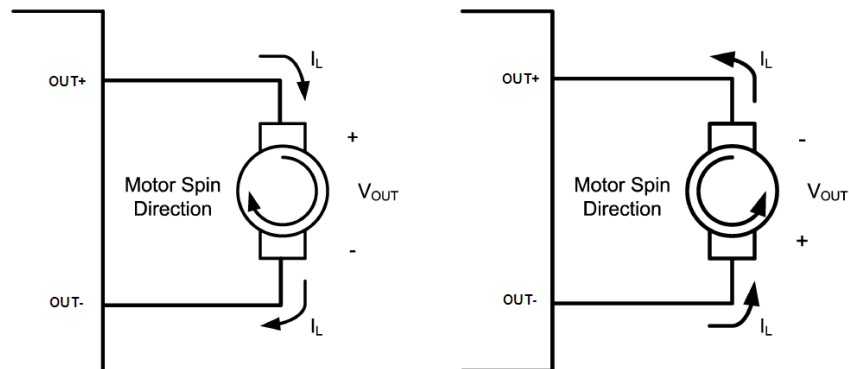

**Figure 13. LRA Example for 1/2 Full-Scale Drive**

The DRV8601 is designed to drive a DC motor (also known as Eccentric Rotating Mass or ERM in haptics terminology) in both clockwise and counter-clockwise directions, as well as to stop the motor quickly. This is made possible because the outputs are fully differential and capable of sourcing and sinking current. This feature helps eliminate long vibration tails which are undesirable in haptic feedback systems.



## Feature Description (continued)



Copyright © 2016, Texas Instruments Incorporated

**Figure 14. Reversal of Direction of Motor Spin Using DRV8601**

Another common approach to driving DC motors is the concept of overdrive voltage. To overcome the inertia of the mass of the motor, they are often overdriven for a short amount of time before returning to the rated voltage of the motor in order to sustain the rotation of the motor. The DRV8601 can overdrive a motor up to the  $V_{DD}$  voltage. Overdrive is also used to stop (or brake) a motor quickly. The DRV8601 can brake up to a voltage of  $-V_{DD}$ . For safe and reliable overdrive voltage and duration, refer to the data sheet of the motor.

### 7.3.2 Internal Reference

The internal voltage divider at the REFOUT pin of this device sets a mid-supply voltage for internal references and sets the output common mode voltage to  $V_{DD}/2$ . Adding a capacitor to this pin filters any noise into this pin and increases the PSRR. REFOUT also determines the rise time of  $VO+$  and  $VO-$  when the device is taken out of shutdown. The larger the capacitor, the slower the rise time. Although the output rise time depends on the bypass capacitor value.

### 7.3.3 Shutdown Mode

DRV8601 has a shutdown mode which is controlled using the EN pin. EN pin is 1.8-V compatible. By pulling EN pin low, the device enters low power state, consuming only 10 nA of shutdown current.

## 7.4 Device Functional Modes

DRV8601 is an analog input with differential output. DRV8601 does not require any digital interface to set up the device. DRV8601 can be configured in various modes by configuring the device in differential or single ended mode as described in [Application and Implementation](#).

## 8 Application and Implementation

### NOTE

Information in the following applications sections is not part of the TI component specification, and TI does not warrant its accuracy or completeness. TI's customers are responsible for determining suitability of components for their purposes. Customers should validate and test their design implementation to confirm system functionality.

### 8.1 Application Information

The DRV8601 is intended to be used for haptic applications in a portable product that already has an application processor with analog output interface. As DRV8601 accepts PWM input, it can be directly hooked up to the processor GPIO and can drive PWM outputs.

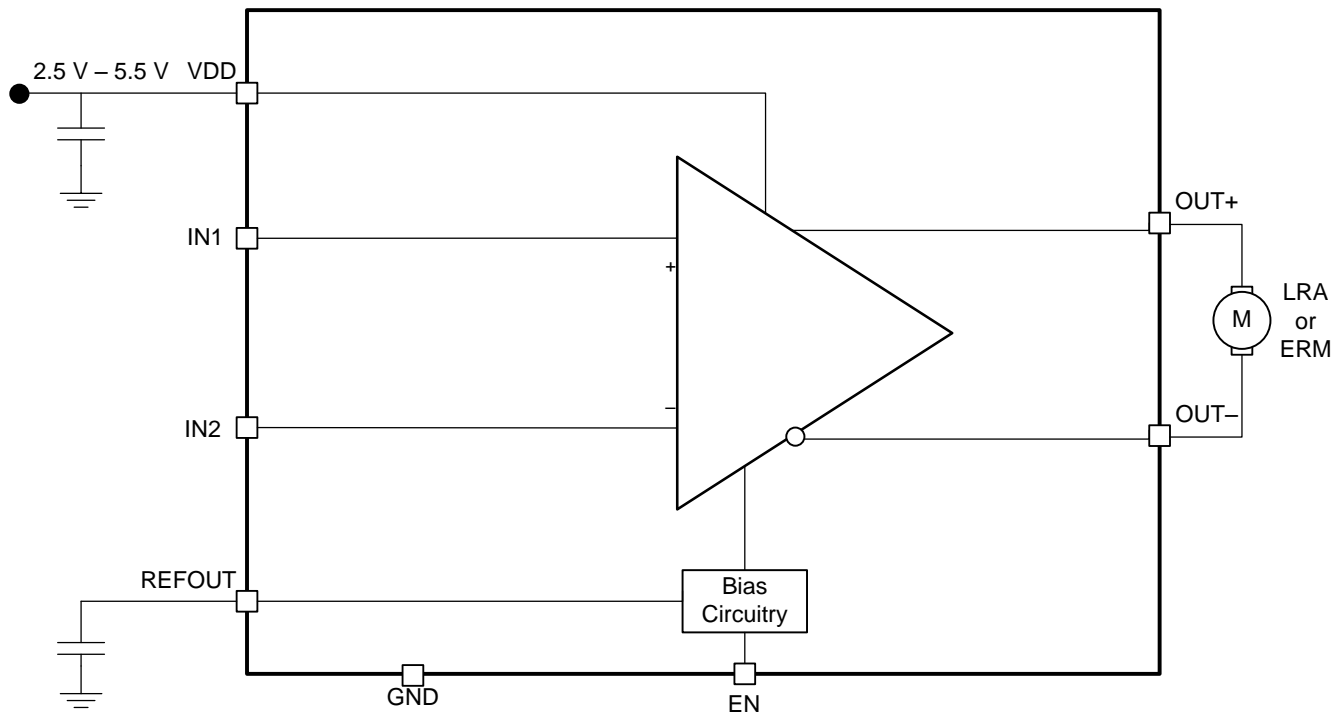

Copyright © 2016, Texas Instruments Incorporated

**Figure 15. Typical Application Block Diagram**

DRV8601 can be operated in different instances as listed in [Typical Applications](#) which facilitates in the design process for system engineers.

## 8.2 Typical Applications

### 8.2.1 Pseudo-Differential Feedback with Internal Reference

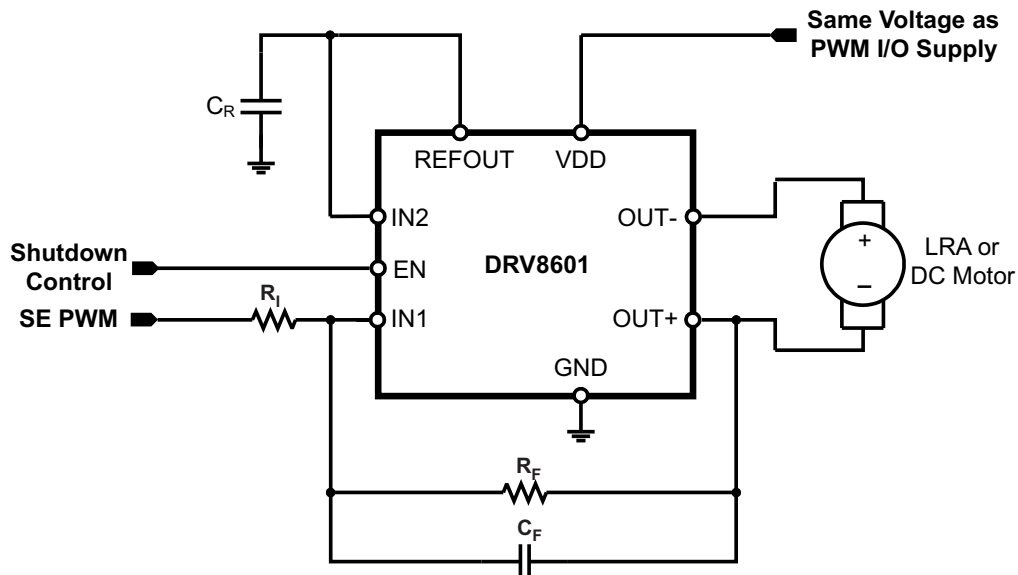

Copyright © 2016, Texas Instruments Incorporated

Figure 16. Pseudo-Differential Feedback with Internal Reference

## Typical Applications (continued)

### 8.2.1.1 Design Requirements

The parameters are located in [Table 2](#).

**Table 2. Design Parameters**

PARAMETER	EXAMPLE
Power supply	2.5 V – 5.5 V
Host processor	PWM output
	GPIO control
Actuator type	LRA or ERMs

### 8.2.1.2 Detailed Design Procedure

In the pseudo-differential feedback configuration ([Figure 16](#)), feedback is taken from only one of the output pins, thereby reducing the number of external components required for the solution. The DRV8601 has an internal reference voltage generator which keeps the REFOUT voltage at  $V_{DD}/2$ . The internal reference voltage can be used if and only if the PWM voltage is the same as the supply voltage of the DRV8601 (if  $V_{PWM} = V_{DD}$ , as assumed in this section).

Having  $V_{PWM} = V_{DD}$  ensures that there is no voltage signal applied to the motor at a PWM duty cycle of 50%. This is a convenient way of temporarily stopping the motor without powering off the DRV8601. Also, this configuration ensures that the direction of rotation of the motor changes when crossing a PWM duty cycle of 50% in both directions. For example, if an ERM motor rotates in the clockwise direction at 20% duty cycle, it will rotate in the counter-clockwise direction at 80% duty cycle at nearly the same speed.

Mathematically, the output voltage is given by [Equation 1](#):

$$V_{O,DIFF} = 2 \times \left( V_{IN} - \frac{V_{DD}}{2} \right) \times \frac{R_F}{R_I} \times \frac{1}{1 + sR_F C_F}$$

where

- $sR_F C_F$  is the Laplace Transform variable
  - $V_{IN}$  is the single-ended input voltage
- (1)

$R_F$  is normally set equal to  $R_I$  ( $R_F = R_I$ ) so that an overdrive voltage of  $V_{DD}$  is achieved when the PWM duty cycle is set to 100%. The optional feedback capacitor,  $C_F$ , forms a low-pass filter together with the feedback resistor  $R_F$ , and therefore, the output differential voltage is a function of the average value of the input PWM signal. When driving a motor, design the cutoff frequency of the low-pass filter to be sufficiently *lower than* the PWM frequency in order to eliminate the PWM frequency and its harmonics from entering the motor. This is desirable when driving motors which do not sufficiently reject the PWM frequency by themselves. When driving a linear vibrator in this configuration, if the feedback capacitor  $C_F$  is used, care must be taken to make sure that the low-pass cutoff frequency is *higher than* the resonant frequency of the linear vibrator.

When driving motors which can sufficiently reject the PWM frequency by themselves, the feedback capacitor may be eliminated. For this example, the output voltage is given by [Equation 2](#):

$$V_{O,DIFF} = 2 \times \left( V_{IN} - \frac{V_{DD}}{2} \right) \times \frac{R_F}{R_I}$$
(2)

where the only difference from [Equation 1](#) is that the filtering action of the capacitor is not present.

**Table 3. Component Design Table**

COMPONENT	VALUE
CR	10 nF / 6.3 V
RI	50 K / 0.01%
RF	50 K / 0.01%
CF	0.01 $\mu$ F / 6.3 V

### 8.2.1.3 Application Curves

Table 4 lists the application curves for this application and following applications from [Typical Characteristics](#).

**Table 4. Table of Graphs**

		FIGURE
Output voltage (High)	vs Load current	<a href="#">Figure 1</a>
Output voltage (Low)	vs Load current	<a href="#">Figure 2</a>
Output voltage	vs Input voltage, $R_L = 10 \Omega$	<a href="#">Figure 3</a>
Output voltage	vs Input voltage, $R_L = 20 \Omega$	<a href="#">Figure 4</a>
Supply current	vs Supply voltage	<a href="#">Figure 5</a>
Shutdown supply current	vs Supply voltage	<a href="#">Figure 6</a>
Power dissipation	vs Supply voltage	<a href="#">Figure 7</a>
Slew rate	vs Supply voltage	<a href="#">Figure 8</a>
Output transition	vs Time	<a href="#">Figure 9</a> , <a href="#">Figure 10</a>
Startup	vs Time	<a href="#">Figure 11</a>
Shutdown	vs Time	<a href="#">Figure 12</a>

### 8.2.2 Pseudo-Differential Feedback with Level-Shifter

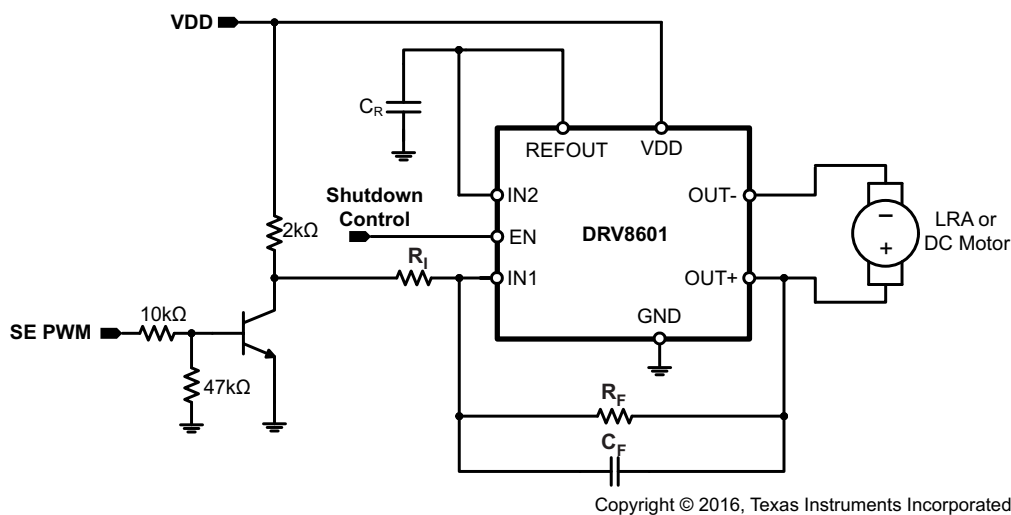

**Figure 17. Pseudo-Differential Feedback with Level-Shifter**

#### 8.2.2.1 Design Requirements

The parameters are located in [Table 5](#).

**Table 5. Design Parameters**

PARAMETER	EXAMPLE
Power supply	2.5 V – 5.5 V
Host processor	PWM output
	GPIO control
Actuator type	LRA or ERMs

### 8.2.2.2 Detailed Design Procedure

This configuration is desirable when a regulated supply voltage for the DRV8601 ( $V_{DD}$ ) is available, but that voltage is different than the PWM input voltage ( $V_{PWM}$ ). A single NPN transistor can be used as a low-cost level shifting solution. This ensures that  $V_{IN} = V_{DD}$  even when  $V_{PWM} \neq V_{DD}$ . A regulated supply for the DRV8601 is still recommended in this scenario. If the supply voltage varies, the PWM level shifter output will follow, and this will, in turn, cause a change in vibration strength. However, if the variance is acceptable, the DRV8601 will still operate properly when connected directly to a battery, for example. A 50% duty cycle will still translate to zero vibration strength across the life cycle of the battery.  $R_F$  is normally set equal to  $R_I$  ( $R_F = R_I$ ) so that an overdrive voltage of  $V_{DD}$  is achieved when the PWM duty cycle is set to 100%.

**Table 6. Component Design Table**

COMPONENT	VALUE
CR	10 nF / 6.3 V
RI	50 K / 0.01%
RF	50 K / 0.01%
CF	0.01 $\mu$ F / 6.3 V

### 8.2.3 Differential Feedback With External Reference

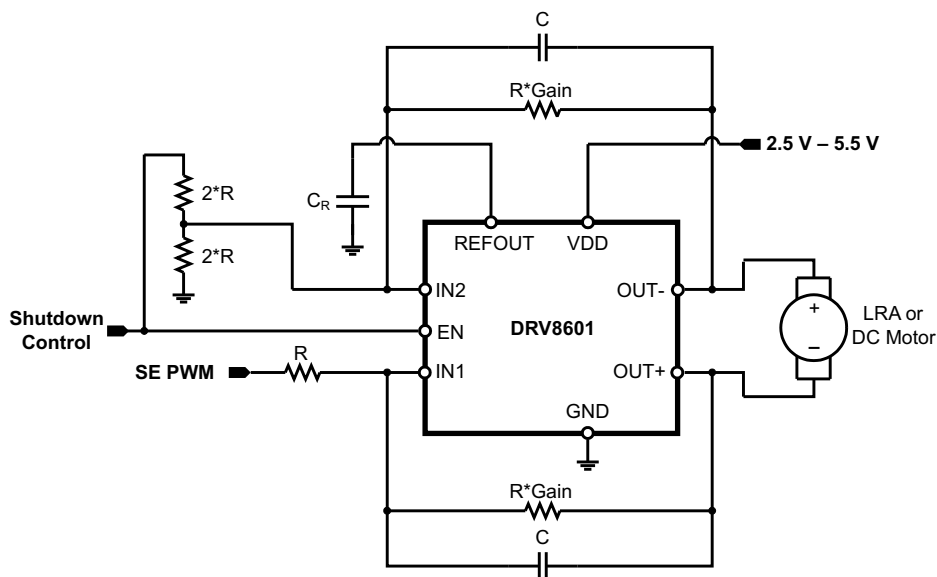

Copyright © 2016, Texas Instruments Incorporated

**Figure 18. Differential Feedback with External Reference**

#### 8.2.3.1 Design Requirements

The parameters are located in [Table 7](#).

**Table 7. Design Parameters**

PARAMETER	EXAMPLE
Power supply	2.5 V – 5.5 V
Host processor	PWM output
	GPIO control
Gain	1
Actuator type	LRA or ERMs

### 8.2.3.2 Detailed Design Procedure

This configuration is useful for connecting the DRV8601 to an unregulated power supply, most commonly a battery. The gain can then be independently set so that the required motor overdrive voltage can be achieved even when  $V_{PWM} < V_{DD}$ . This is often the case when  $V_{PWM} = 1.8\text{ V}$ , and the desired overdrive voltage is 3.0 V or above. Note that  $V_{DD}$  must be greater than or equal to the desired overdrive voltage. A resistor divider can be used to create a  $V_{PWM}/2$  reference for the DRV8601. If the shutdown control voltage is driven by a GPIO in the same supply domain as  $V_{PWM}$ , it can be used to supply the resistor divider as in [Figure 18](#) so that no current is drawn by the divider in shutdown.

In this configuration, feedback is taken from both output pins. The output voltage is given by [Equation 3](#):

$$V_{O,DIFF} = \left( V_{IN} - \frac{V_{PWM}}{2} \right) \times \frac{R_F}{R_I} \times \frac{1}{1 + sR_F C_F}$$

where

- $sR_F C_F$  is the Laplace Transform variable
  - $V_{IN}$  is the single-ended input voltage
- (3)

Note that this differs from [Equation 1](#) for the pseudo-differential configuration by a factor of 2 because of differential feedback. The optional feedback capacitor  $C_F$  forms a low-pass filter together with the feedback resistor  $R_F$ , and therefore, the output differential voltage is a function of the average value of the input PWM signal  $V_{IN}$ . When driving a motor, design the cutoff frequency of the low-pass filter to be sufficiently *lower than* the PWM frequency in order to eliminate the PWM frequency and its harmonics from entering the motor. This is desirable when driving motors which do not sufficiently reject the PWM frequency by themselves. When driving a linear vibrator in this configuration, if the feedback capacitor  $C_F$  is used, care must be taken to make sure that the low-pass cutoff frequency is *higher than* the resonant frequency of the linear vibrator.

When driving motors which can sufficiently reject the PWM frequency by themselves, the feedback capacitor may be eliminated. For this example, the output voltage is given by [Equation 4](#):

$$V_{O,DIFF} = \left( V_{IN} - \frac{V_{PWM}}{2} \right) \times \frac{R_F}{R_I}$$
(4)

Where the only difference from [Equation 3](#) is that the filtering action of the capacitor is not present.

#### 8.2.3.2.1 Selecting Components

##### 8.2.3.2.1.1 Resistors $R_I$ and $R_F$

Choose  $R_F$  and  $R_I$  in the range of 20 k $\Omega$  to 100 k $\Omega$  for stable operation.

##### 8.2.3.2.1.2 Capacitor $C_F$

This capacitor filters any noise on the reference voltage generated by the DRV8601 on the REFOUT pin, thereby increasing noise immunity. However, a high value of capacitance results in a large turn-on time. A typical value of 1 nF is recommended for a fast turn-on time. All capacitors should be X5R dielectric or better.

**Table 8. Component Design Table**

COMPONENT	VALUE
CR	10 nF / 6.3 V
RI	50 K / 0.01%
RF	50 K / 0.01%
CF	0.01 $\mu$ F / 6.3 V

## 9 Power Supply Recommendations

The DRV8601 device is designed to operate from an input-voltage supply range between 2.5 to 5.5 V. The decoupling capacitor for the power supply should be placed closed to the device pin.

## 10 Layout

### 10.1 Layout Guidelines

Use the following guidelines for the DRV8601 layout:

- The decoupling capacitor for the power supply ( $V_{DD}$ ) should be placed closed to the device pin.
- The REFOUT capacitor should be placed close to the device REFOUT pin.

### 10.2 Layout Example

Figure 19 shows a typical example of the layout for DRV8601. It is important that the power supply decoupling caps and the REFOUT external capacitance be connected as close to the device as possible.

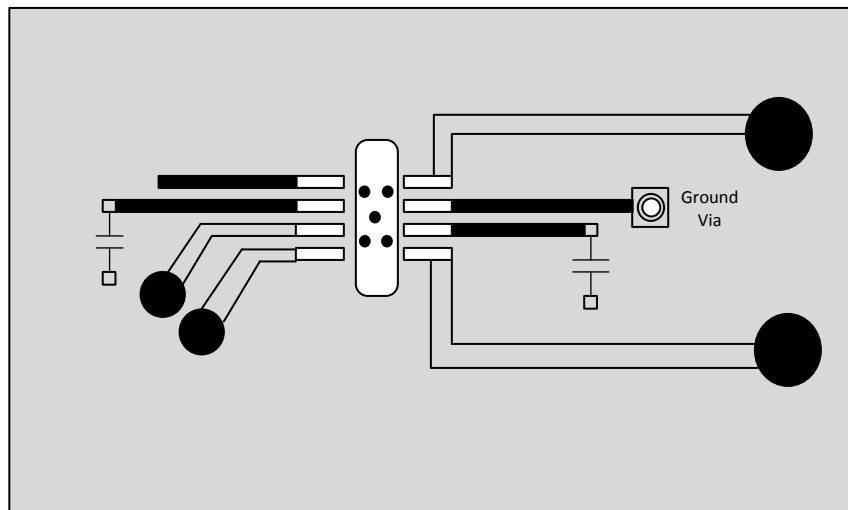

Figure 19. Typical Layout Example

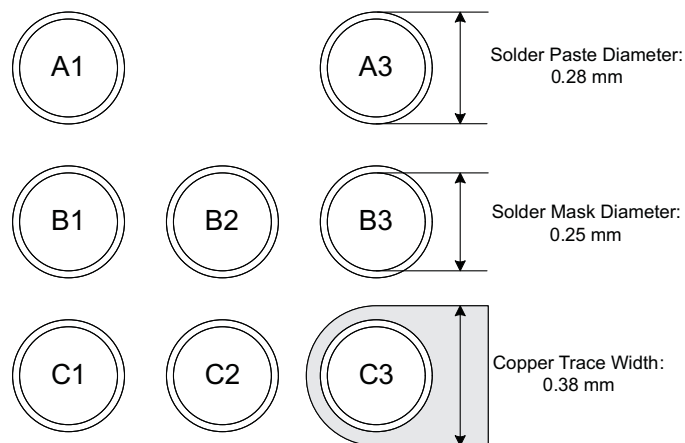

Figure 20. ZQV Land Pattern



## 11 Device and Documentation Support

### 11.1 Receiving Notification of Documentation Updates

To receive notification of documentation updates, navigate to the device product folder on ti.com. In the upper right corner, click on *Alert me* to register and receive a weekly digest of any product information that has changed. For change details, review the revision history included in any revised document.

### 11.2 Community Resources

The following links connect to TI community resources. Linked contents are provided "AS IS" by the respective contributors. They do not constitute TI specifications and do not necessarily reflect TI's views; see TI's [Terms of Use](#).

**TI E2E™ Online Community** *TI's Engineer-to-Engineer (E2E) Community*. Created to foster collaboration among engineers. At e2e.ti.com, you can ask questions, share knowledge, explore ideas and help solve problems with fellow engineers.

**Design Support** *TI's Design Support* Quickly find helpful E2E forums along with design support tools and contact information for technical support.

### 11.3 Trademarks

MicroStar Junior, E2E are trademarks of Texas Instruments.  
All other trademarks are the property of their respective owners.

### 11.4 Electrostatic Discharge Caution



These devices have limited built-in ESD protection. The leads should be shorted together or the device placed in conductive foam during storage or handling to prevent electrostatic damage to the MOS gates.

### 11.5 Glossary

[SLYZ022](#) — *TI Glossary*.

This glossary lists and explains terms, acronyms, and definitions.

## 12 Mechanical, Packaging, and Orderable Information

The following pages include mechanical, packaging, and orderable information. This information is the most current data available for the designated devices. This data is subject to change without notice and revision of this document. For browser-based versions of this data sheet, refer to the left-hand navigation.

**PACKAGING INFORMATION**

Orderable Device	Status (1)	Package Type	Package Drawing	Pins	Package Qty	Eco Plan (2)	Lead/Ball Finish (6)	MSL Peak Temp (3)	Op Temp (°C)	Device Marking (4/5)	Samples
DRV8601DRBR	ACTIVE	SON	DRB	8	3000	Green (RoHS & no Sb/Br)	CU NIPDAU	Level-2-260C-1 YEAR	-40 to 85	8601	<a href="#">Samples</a>
DRV8601DRBT	ACTIVE	SON	DRB	8	250	Green (RoHS & no Sb/Br)	CU NIPDAU	Level-2-260C-1 YEAR	-40 to 85	8601	<a href="#">Samples</a>
DRV8601ZQVR	ACTIVE	BGA MICROSTAR JUNIOR	ZQV	8	2500	Green (RoHS & no Sb/Br)	SNAGCU	Level-2-260C-1 YEAR	-40 to 85	HSMI	<a href="#">Samples</a>

(1) The marketing status values are defined as follows:

**ACTIVE:** Product device recommended for new designs.

**LIFEBUY:** TI has announced that the device will be discontinued, and a lifetime-buy period is in effect.

**NRND:** Not recommended for new designs. Device is in production to support existing customers, but TI does not recommend using this part in a new design.

**PREVIEW:** Device has been announced but is not in production. Samples may or may not be available.

**OBSOLETE:** TI has discontinued the production of the device.

(2) Eco Plan - The planned eco-friendly classification: Pb-Free (RoHS), Pb-Free (RoHS Exempt), or Green (RoHS & no Sb/Br) - please check <http://www.ti.com/productcontent> for the latest availability information and additional product content details.

**TBD:** The Pb-Free/Green conversion plan has not been defined.

**Pb-Free (RoHS):** TI's terms "Lead-Free" or "Pb-Free" mean semiconductor products that are compatible with the current RoHS requirements for all 6 substances, including the requirement that lead not exceed 0.1% by weight in homogeneous materials. Where designed to be soldered at high temperatures, TI Pb-Free products are suitable for use in specified lead-free processes.

**Pb-Free (RoHS Exempt):** This component has a RoHS exemption for either 1) lead-based flip-chip solder bumps used between the die and package, or 2) lead-based die adhesive used between the die and leadframe. The component is otherwise considered Pb-Free (RoHS compatible) as defined above.

**Green (RoHS & no Sb/Br):** TI defines "Green" to mean Pb-Free (RoHS compatible), and free of Bromine (Br) and Antimony (Sb) based flame retardants (Br or Sb do not exceed 0.1% by weight in homogeneous material)

(3) MSL, Peak Temp. - The Moisture Sensitivity Level rating according to the JEDEC industry standard classifications, and peak solder temperature.

(4) There may be additional marking, which relates to the logo, the lot trace code information, or the environmental category on the device.

(5) Multiple Device Markings will be inside parentheses. Only one Device Marking contained in parentheses and separated by a "~" will appear on a device. If a line is indented then it is a continuation of the previous line and the two combined represent the entire Device Marking for that device.

(6) Lead/Ball Finish - Orderable Devices may have multiple material finish options. Finish options are separated by a vertical ruled line. Lead/Ball Finish values may wrap to two lines if the finish value exceeds the maximum column width.

**Important Information and Disclaimer:** The information provided on this page represents TI's knowledge and belief as of the date that it is provided. TI bases its knowledge and belief on information provided by third parties, and makes no representation or warranty as to the accuracy of such information. Efforts are underway to better integrate information from third parties. TI has taken and continues to take reasonable steps to provide representative and accurate information but may not have conducted destructive testing or chemical analysis on incoming materials and chemicals. TI and TI suppliers consider certain information to be proprietary, and thus CAS numbers and other limited information may not be available for release.

In no event shall TI's liability arising out of such information exceed the total purchase price of the TI part(s) at issue in this document sold by TI to Customer on an annual basis.

**TAPE AND REEL INFORMATION**

**QUADRANT ASSIGNMENTS FOR PIN 1 ORIENTATION IN TAPE**

\*All dimensions are nominal

Device	Package Type	Package Drawing	Pins	SPQ	Reel Diameter (mm)	Reel Width W1 (mm)	A0 (mm)	B0 (mm)	K0 (mm)	P1 (mm)	W (mm)	Pin1 Quadrant
DRV8601DRBR	SON	DRB	8	3000	330.0	12.4	3.3	3.3	1.1	8.0	12.0	Q2
DRV8601DRBT	SON	DRB	8	250	180.0	12.4	3.3	3.3	1.1	8.0	12.0	Q2
DRV8601ZQVR	BGA MICROSTAR JUNIOR	ZQV	8	2500	330.0	8.4	2.3	2.3	1.4	4.0	8.0	Q1
DRV8601ZQVR	BGA MICROSTAR JUNIOR	ZQV	8	2500	330.0	8.4	2.3	2.3	1.4	4.0	8.0	Q1

**TAPE AND REEL BOX DIMENSIONS**

\*All dimensions are nominal

Device	Package Type	Package Drawing	Pins	SPQ	Length (mm)	Width (mm)	Height (mm)
DRV8601DRBR	SON	DRB	8	3000	367.0	367.0	35.0
DRV8601DRBT	SON	DRB	8	250	210.0	185.0	35.0
DRV8601ZQVR	BGA MICROSTAR JUNIOR	ZQV	8	2500	336.6	336.6	28.6
DRV8601ZQVR	BGA MICROSTAR JUNIOR	ZQV	8	2500	338.1	338.1	20.6

**DRB 8**

**GENERIC PACKAGE VIEW**

**VSON - 1 mm max height**

PLASTIC SMALL OUTLINE - NO LEAD



Images above are just a representation of the package family, actual package may vary.  
Refer to the product data sheet for package details.

4203482/L

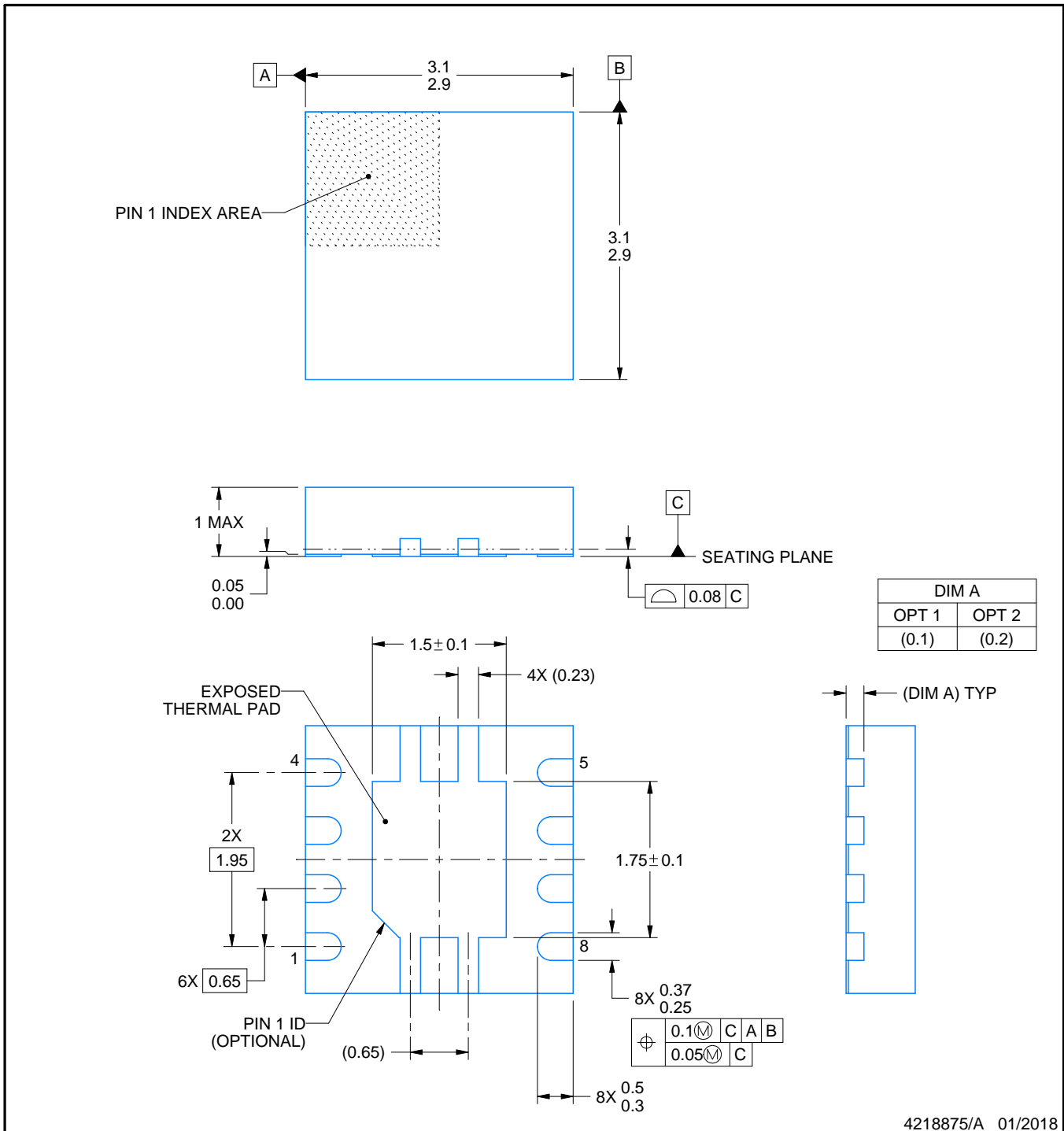

4218875/A 01/2018

NOTES:

1. All linear dimensions are in millimeters. Any dimensions in parenthesis are for reference only. Dimensioning and tolerancing per ASME Y14.5M.
2. This drawing is subject to change without notice.
3. The package thermal pad must be soldered to the printed circuit board for thermal and mechanical performance.

# EXAMPLE BOARD LAYOUT

DRB0008A

VSON - 1 mm max height

PLASTIC SMALL OUTLINE - NO LEAD



LAND PATTERN EXAMPLE  
EXPOSED METAL SHOWN  
SCALE:20X

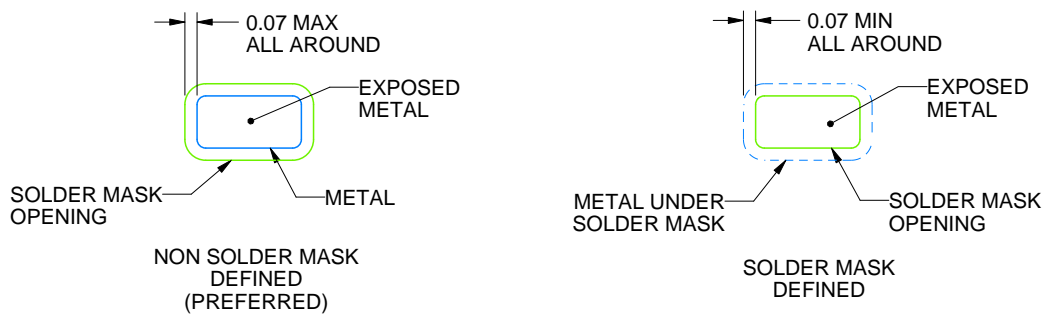

SOLDER MASK DETAILS

4218875/A 01/2018

NOTES: (continued)

4. This package is designed to be soldered to a thermal pad on the board. For more information, see Texas Instruments literature number SLUA271 ([www.ti.com/lit/slua271](http://www.ti.com/lit/slua271)).
5. Vias are optional depending on application, refer to device data sheet. If any vias are implemented, refer to their locations shown on this view. It is recommended that vias under paste be filled, plugged or tented.



# EXAMPLE STENCIL DESIGN

DRB0008A

VSON - 1 mm max height

PLASTIC SMALL OUTLINE - NO LEAD



SOLDER PASTE EXAMPLE  
BASED ON 0.125 mm THICK STENCIL

EXPOSED PAD  
84% PRINTED SOLDER COVERAGE BY AREA  
SCALE:25X

4218875/A 01/2018

NOTES: (continued)

6. Laser cutting apertures with trapezoidal walls and rounded corners may offer better paste release. IPC-7525 may have alternate design recommendations.

## ZQV (S-PBGA-N8)

## PLASTIC BALL GRID ARRAY

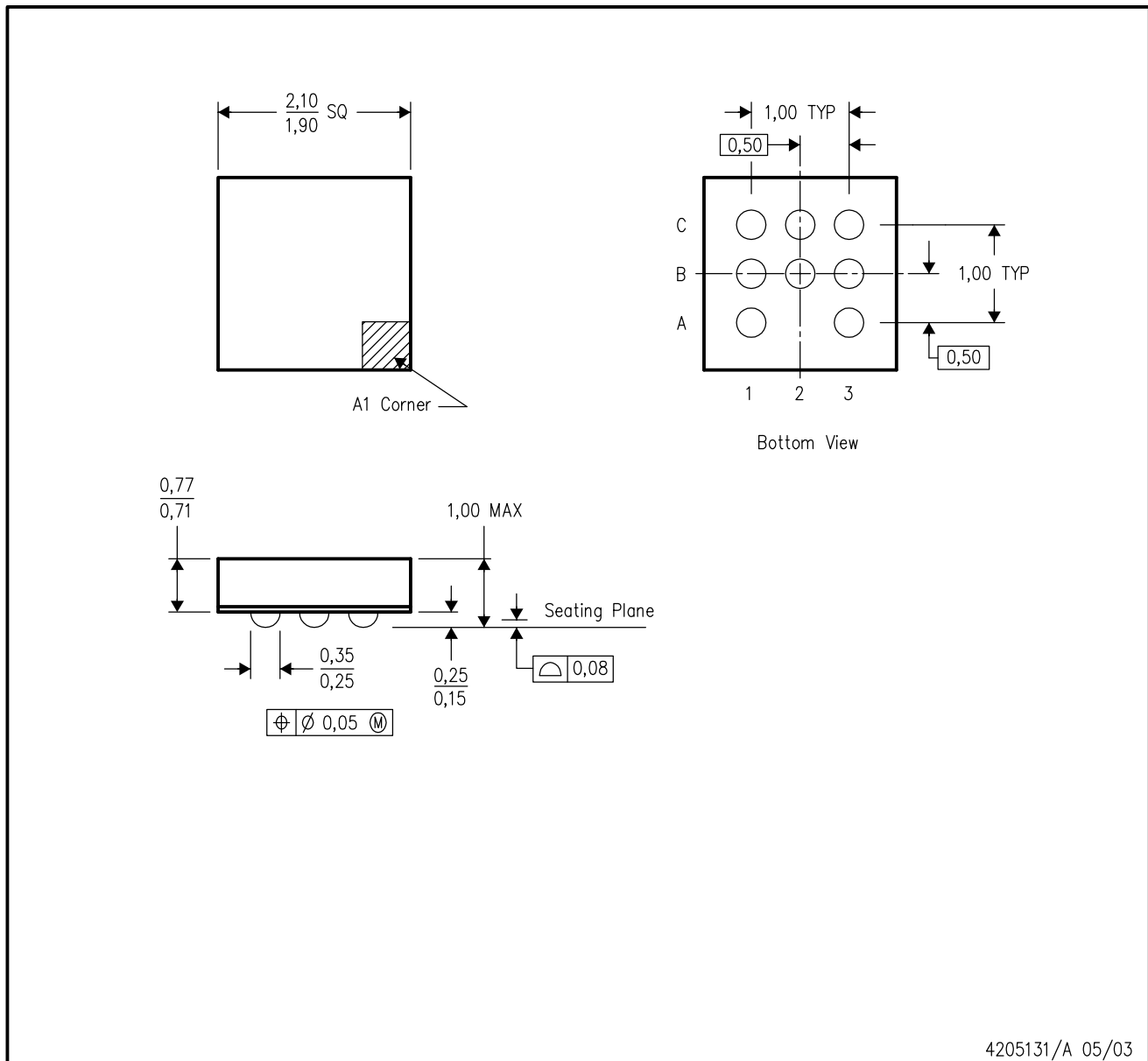

- NOTES:
- All linear dimensions are in millimeters.
  - This drawing is subject to change without notice.
  - MicroStar Junior configuration
  - Falls within JEDEC MO-225
  - This package is lead-free.

## IMPORTANT NOTICE

Texas Instruments Incorporated (TI) reserves the right to make corrections, enhancements, improvements and other changes to its semiconductor products and services per JESD46, latest issue, and to discontinue any product or service per JESD48, latest issue. Buyers should obtain the latest relevant information before placing orders and should verify that such information is current and complete.

TI's published terms of sale for semiconductor products (<http://www.ti.com/sc/docs/stdterms.htm>) apply to the sale of packaged integrated circuit products that TI has qualified and released to market. Additional terms may apply to the use or sale of other types of TI products and services.

Reproduction of significant portions of TI information in TI data sheets is permissible only if reproduction is without alteration and is accompanied by all associated warranties, conditions, limitations, and notices. TI is not responsible or liable for such reproduced documentation. Information of third parties may be subject to additional restrictions. Resale of TI products or services with statements different from or beyond the parameters stated by TI for that product or service voids all express and any implied warranties for the associated TI product or service and is an unfair and deceptive business practice. TI is not responsible or liable for any such statements.

Buyers and others who are developing systems that incorporate TI products (collectively, "Designers") understand and agree that Designers remain responsible for using their independent analysis, evaluation and judgment in designing their applications and that Designers have full and exclusive responsibility to assure the safety of Designers' applications and compliance of their applications (and of all TI products used in or for Designers' applications) with all applicable regulations, laws and other applicable requirements. Designer represents that, with respect to their applications, Designer has all the necessary expertise to create and implement safeguards that (1) anticipate dangerous consequences of failures, (2) monitor failures and their consequences, and (3) lessen the likelihood of failures that might cause harm and take appropriate actions. Designer agrees that prior to using or distributing any applications that include TI products, Designer will thoroughly test such applications and the functionality of such TI products as used in such applications.

TI's provision of technical, application or other design advice, quality characterization, reliability data or other services or information, including, but not limited to, reference designs and materials relating to evaluation modules, (collectively, "TI Resources") are intended to assist designers who are developing applications that incorporate TI products; by downloading, accessing or using TI Resources in any way, Designer (individually or, if Designer is acting on behalf of a company, Designer's company) agrees to use any particular TI Resource solely for this purpose and subject to the terms of this Notice.

TI's provision of TI Resources does not expand or otherwise alter TI's applicable published warranties or warranty disclaimers for TI products, and no additional obligations or liabilities arise from TI providing such TI Resources. TI reserves the right to make corrections, enhancements, improvements and other changes to its TI Resources. TI has not conducted any testing other than that specifically described in the published documentation for a particular TI Resource.

Designer is authorized to use, copy and modify any individual TI Resource only in connection with the development of applications that include the TI product(s) identified in such TI Resource. NO OTHER LICENSE, EXPRESS OR IMPLIED, BY ESTOPPEL OR OTHERWISE TO ANY OTHER TI INTELLECTUAL PROPERTY RIGHT, AND NO LICENSE TO ANY TECHNOLOGY OR INTELLECTUAL PROPERTY RIGHT OF TI OR ANY THIRD PARTY IS GRANTED HEREIN, including but not limited to any patent right, copyright, mask work right, or other intellectual property right relating to any combination, machine, or process in which TI products or services are used. Information regarding or referencing third-party products or services does not constitute a license to use such products or services, or a warranty or endorsement thereof. Use of TI Resources may require a license from a third party under the patents or other intellectual property of the third party, or a license from TI under the patents or other intellectual property of TI.

TI RESOURCES ARE PROVIDED "AS IS" AND WITH ALL FAULTS. TI DISCLAIMS ALL OTHER WARRANTIES OR REPRESENTATIONS, EXPRESS OR IMPLIED, REGARDING RESOURCES OR USE THEREOF, INCLUDING BUT NOT LIMITED TO ACCURACY OR COMPLETENESS, TITLE, ANY EPIDEMIC FAILURE WARRANTY AND ANY IMPLIED WARRANTIES OF MERCHANTABILITY, FITNESS FOR A PARTICULAR PURPOSE, AND NON-INFRINGEMENT OF ANY THIRD PARTY INTELLECTUAL PROPERTY RIGHTS. TI SHALL NOT BE LIABLE FOR AND SHALL NOT DEFEND OR INDEMNIFY DESIGNER AGAINST ANY CLAIM, INCLUDING BUT NOT LIMITED TO ANY INFRINGEMENT CLAIM THAT RELATES TO OR IS BASED ON ANY COMBINATION OF PRODUCTS EVEN IF DESCRIBED IN TI RESOURCES OR OTHERWISE. IN NO EVENT SHALL TI BE LIABLE FOR ANY ACTUAL, DIRECT, SPECIAL, COLLATERAL, INDIRECT, PUNITIVE, INCIDENTAL, CONSEQUENTIAL OR EXEMPLARY DAMAGES IN CONNECTION WITH OR ARISING OUT OF TI RESOURCES OR USE THEREOF, AND REGARDLESS OF WHETHER TI HAS BEEN ADVISED OF THE POSSIBILITY OF SUCH DAMAGES.

Unless TI has explicitly designated an individual product as meeting the requirements of a particular industry standard (e.g., ISO/TS 16949 and ISO 26262), TI is not responsible for any failure to meet such industry standard requirements.

Where TI specifically promotes products as facilitating functional safety or as compliant with industry functional safety standards, such products are intended to help enable customers to design and create their own applications that meet applicable functional safety standards and requirements. Using products in an application does not by itself establish any safety features in the application. Designers must ensure compliance with safety-related requirements and standards applicable to their applications. Designer may not use any TI products in life-critical medical equipment unless authorized officers of the parties have executed a special contract specifically governing such use. Life-critical medical equipment is medical equipment where failure of such equipment would cause serious bodily injury or death (e.g., life support, pacemakers, defibrillators, heart pumps, neurostimulators, and implantables). Such equipment includes, without limitation, all medical devices identified by the U.S. Food and Drug Administration as Class III devices and equivalent classifications outside the U.S.

TI may expressly designate certain products as completing a particular qualification (e.g., Q100, Military Grade, or Enhanced Product). Designers agree that it has the necessary expertise to select the product with the appropriate qualification designation for their applications and that proper product selection is at Designers' own risk. Designers are solely responsible for compliance with all legal and regulatory requirements in connection with such selection.

Designer will fully indemnify TI and its representatives against any damages, costs, losses, and/or liabilities arising out of Designer's non-compliance with the terms and provisions of this Notice.