

THIS DOCUMENT IS THE PROPERTY OF
KEYSTONE ELECTRONICS CORP. AND
SHALL NOT BE REPRODUCED, DISTRIBUTED
OR USED AS A BASIS FOR MANUFACTURE
WITHOUT PRIOR WRITTEN PERMISSION
FROM KEYSTONE ELECTRONICS CORP.

ACTUAL SIZE

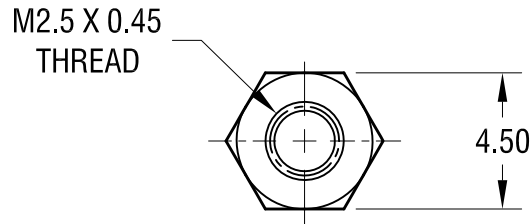

P/N 24331

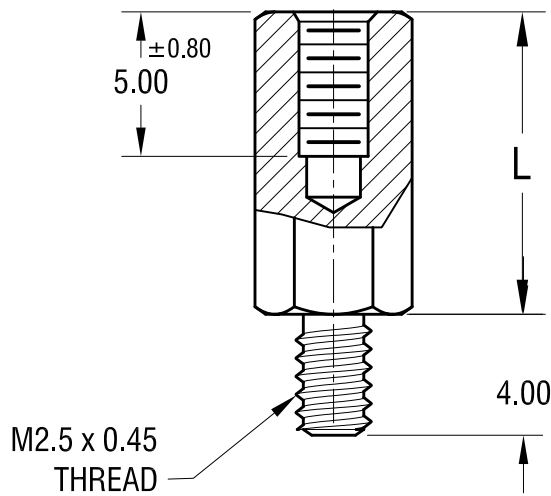

PART NO.	'L' DIM.
24331	10.00
24332	12.00
24333	15.00
24334	18.00
24335	20.00
24336	25.00

NOTE:

1. ALL DIMENSIONS ARE IN MILLIMETERS

KEYSTONE ELECTRONICS CORP.

www.keyelco.com • NEW HYDE PARK, NY 11040 • Tel (516) 328-7500

PART NAME		4.5 mm HEX M/F STANDOFF	
MATERIAL		LEAD FREE ALUMINUM	
FINISH		DRN BY	DATE
CLEAR IRIDITE		BOONE	5.08.06
		APP'D	SCALE
		MR	4X
TOLERANCES	INCH [MM]	CODE	DWG NO.
DECIMAL	± .005 [± 0.13]	C	24331- 24336
ANGULAR	± 1°		
UNLESS OTHERWISE SPECIFIED			

10.19.23	CHANGE AS PER ECN 23-207	A
DATE	DESCRIPTION	REV.