



MATE-N-LOK | Mini-Universal MATE-N-LOK

TE Internal #: 770902-3

Socket Contact, Gold, 600 VAC, 600 VDC, 26 – 22 AWG Wire Size, .12 – .4 mm² Wire Size, Crimp, Brass, Power, Mini-Universal MATE-N-LOK

[View on TE.com >](#)

Connectors > Contacts > Connector Contacts



Contact Type: **Socket**

Contact Mating Area Plating Material: **Gold**

Wire Contact Termination Area Plating Material: **Tin-Lead**

Operating Voltage: **600 VDC**

Features

Product Type Features

Discrete Wire Type	Stranded
--------------------	----------

Electrical Characteristics

Operating Voltage	600 VDC
-------------------	---------

Contact Features

Mating Pin Diameter	1 mm[.039 in]
Contact Underplating Material Thickness	1.27 μm[50 μin]
Wire Contact Termination Area Plating Thickness	2.54 μm[100 μin]
Wire Contact Termination Area Plating Material Finish	Bright
Contact Mating Area Plating Material Thickness	.76 μm[30 μin]
Contact Orientation	Straight
Contact Underplating Material	Nickel
Contact Type	Socket
Contact Mating Area Plating Material	Gold
Wire Contact Termination Area Plating Material	Tin-Lead
Contact Retention Within Housing	With



Contact Base Material	Brass
Contact Current Rating (Max)	11.2 A

Termination Features

Termination Method to Wire & Cable	Crimp
Product Terminates To	Wire & Cable

Mechanical Attachment

Wire Insulation Support	Without
-------------------------	---------

Dimensions

Compatible Insulation Diameter Range	1.19 – 1.75 mm [.047 – .069 in]
Wire Size	.12 – .4 mm ²

Usage Conditions

Operating Temperature Range	-55 – 105 °C [-67 – 221 °F]
-----------------------------	-----------------------------

Operation/Application

Circuit Application	Power
---------------------	-------

Industry Standards

Compatible With Agency/Standards Products	CSA, UL
UL Flammability Rating	UL 94V-0

Packaging Features

Packaging Quantity	7000
Packaging Method	Reel

Product Compliance

For compliance documentation, visit the product page on [TE.com](https://www.te.com)>

EU RoHS Directive 2011/65/EU	Not Compliant
EU ELV Directive 2000/53/EC	Compliant with Exemptions
China RoHS 2 Directive MIIT Order No 32, 2016	Restricted Materials Above Threshold
EU REACH Regulation (EC) No. 1907/2006	Current ECHA Candidate List: JUNE 2024 (241) Candidate List Declared Against: JUNE 2024 (241) SVHC > Threshold: Pb (13% in Component Part)

Article Safe Usage Statements:

Do not eat, drink or smoke when using this product. Wash thoroughly after handling. Recycle if possible and dispose of the article by following all applicable governmental regulations relevant to your geographic location.

Halogen Content

Low Halogen - Br, Cl, F, I < 900 ppm per homogenous material. Also BFR/CFR/PVC Free

Solder Process Capability

Not applicable for solder process capability

Product Compliance Disclaimer

This information is provided based on reasonable inquiry of our suppliers and represents our current actual knowledge based on the information they provided. This information is subject to change. The part numbers that TE has identified as EU RoHS compliant have a maximum concentration of 0.1% by weight in homogenous materials for lead, hexavalent chromium, mercury, PBB, PBDE, DBP, BBP, DEHP, DIBP, and 0.01% for cadmium, or qualify for an exemption to these limits as defined in the Annexes of Directive 2011/65/EU (RoHS2). Finished electrical and electronic equipment products will be CE marked as required by Directive 2011/65/EU. Components may not be CE marked. Additionally, the part numbers that TE has identified as EU ELV compliant have a maximum concentration of 0.1% by weight in homogenous materials for lead, hexavalent chromium, and mercury, and 0.01% for cadmium, or qualify for an exemption to these limits as defined in the Annexes of Directive 2000/53/EC (ELV). Regarding the REACH Regulation, the information TE provides on SVHC in articles for this part number is based on the latest European Chemicals Agency (ECHA) 'Guidance on requirements for substances in articles' posted at this URL: <https://echa.europa.eu/guidance-documents/guidance-on-reach>

Compatible Parts



TE Part # CAT-AM71-C83998EE
Mini Circular Plastic Connectors (CPC)



TE Part # 91529-1
CCII MINI-UMNL PIN 26-22 ASSY

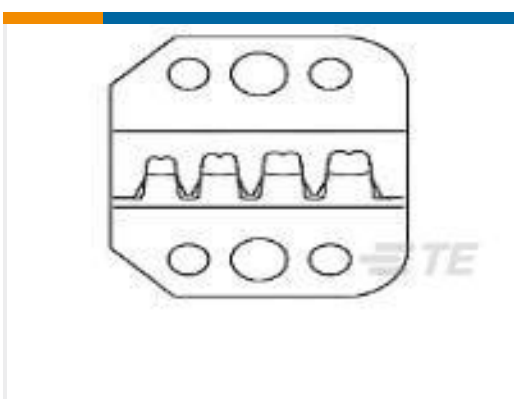

TE Part # 90758-2
PROCRIMP DIE MINI UNIV MNL



TE Part # 189727-1
EXTRACTION TOOL



TE Part # 455830-1
INSERTION TOOL



TE Part # 770586-1
22P MINI UMNL PLUG HSG



TE Part # 794942-1
10P MINI UMNL CAP HSG



TE Part # 770587-1
24P MINI UMNL PLUG HSG



TE Part # 770582-1
14P MINI UMNL PLUG HSG



TE Part # 770585-1
20P MINI UMNL PLUG HSG



TE Part # 172333-1
MINI UNIVERSAL M-N-L HOUSING



TE Part # 794781-1
10P MINI UMNL PLUG HSG



Also in the Series | Mini-Universal MATE-N-LOK

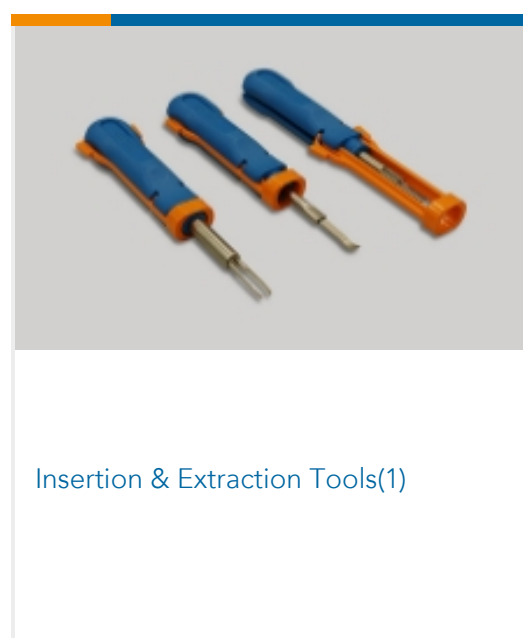
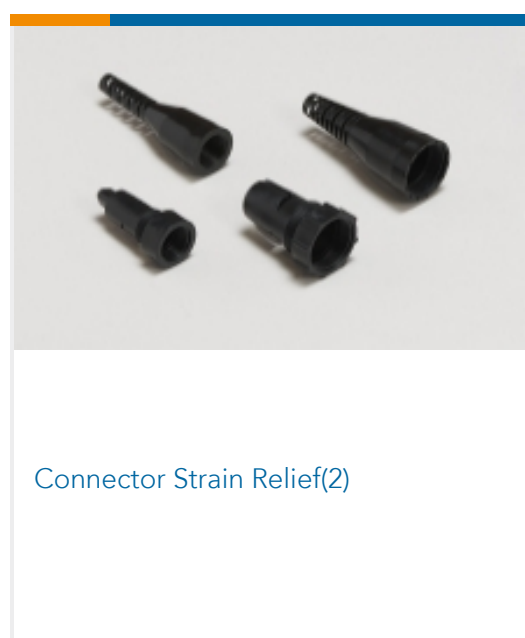
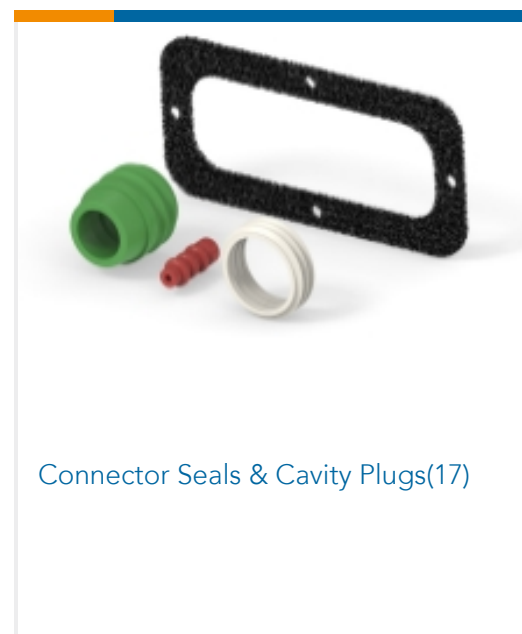
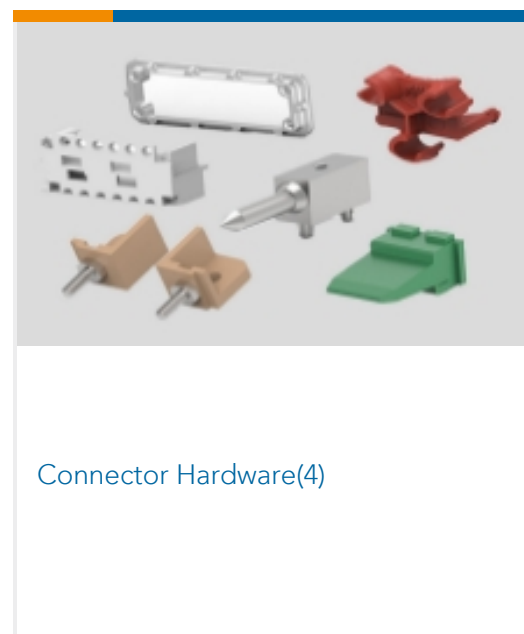
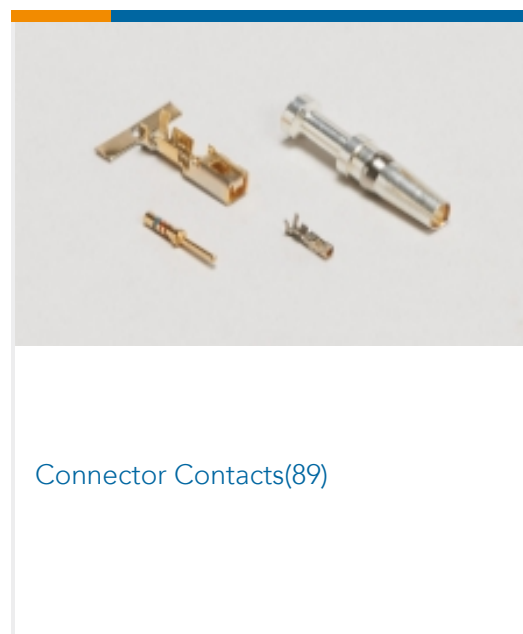
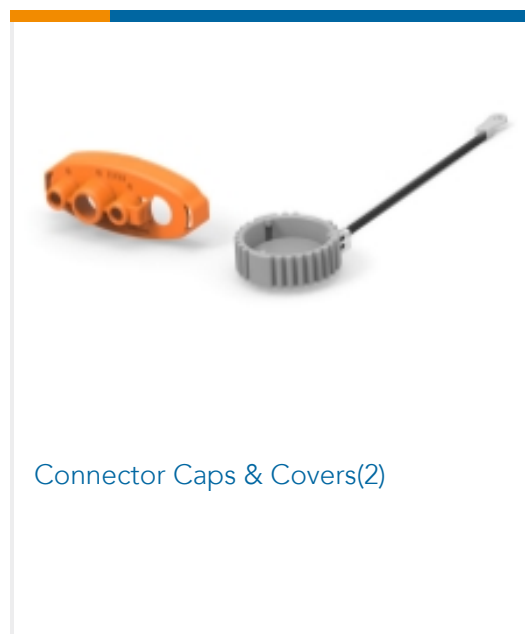

Customers Also Bought



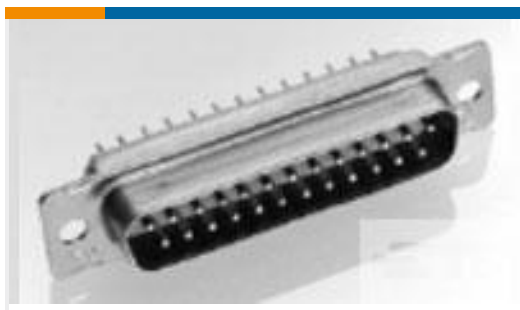

TE Part #443976-1
AMPLIMITE,ASY,RCPT,POSTD,109,1



TE Part #E4100402BGM
E4100402BGM=RELAY

Documents

Product Drawings

[MINI UMNL SOK 26-22 AWG AU](#)

English

CAD Files

Customer View Model

[ENG_CVM_CVM_770902-3_T.2d_dxf.zip](#)

English

[3D PDF](#)

3D

Customer View Model

[ENG_CVM_CVM_770902-3_T.3d_igs.zip](#)

English

Customer View Model

[ENG_CVM_CVM_770902-3_T.3d_stp.zip](#)

English

By downloading the CAD file I accept and agree to the [Terms and Conditions](#) of use.

Datasheets & Catalog Pages

[SOFT_SHELL_PIN_AND_SOCKET_CONNECTORS_CATALOG](#)

English

Product Specifications

[Application Specification](#)

English

Instruction Sheets

[Instruction Sheet \(U.S.\)](#)

English