

MODULAR JACK CHARACTERISTICS LEGEND

EXTERNAL CONNECTOR BODY DIMENSIONS: (SEE NOTES 8 AND 9)
 JACKS ARE AVAILABLE IN STANDARD 4, 6, AND 8 POSITION BODY SIZES

NUMBER OF CONTACT POSITIONS:
 CONNECTOR SIZE 4 CAN ACCOMMODATE 2 OR 4 TERMINALS;
 CONNECTOR SIZE 6 CAN ACCOMMODATE 2, 4, OR 6 TERMINALS;
 CONNECTOR SIZE 8 CAN ACCOMMODATE 2, 4, 6, 8, OR 10 TERMINALS

POLARIZATION OPTION:
 "NO"= JACKS WITHOUT KEYING SLOT
 "YES"= JACKS WITH KEYING SLOT (AVAILABLE ON CONNECTOR SIZE 8 ONLY)

MOUNTING EARS OPTION:
 "YES"= JACKS WITH MOUNTING EARS
 "NO"= JACKS WITHOUT MOUNTING EARS

- NOTES:
- MATERIALS: HOUSING- POLYESTER, GLASS FILLED, UL94V-0, COLOR - BLACK
 TERMINALS- PHOSPHOR BRONZE ALLOY, .015/(0.38) THICK.
 - TERMINAL PLATING:
 SELECT GOLD IN CONTACT AREA: 50 MICROINCHES MIN.,
 *SELECT TIN IN PC TAIL AREA: 100 MICROINCHES MIN.,
 WITH OVERALL NICKEL UNDERPLATE: 50 MICROINCHES MIN.
 *THE PRIMARY SHIPPING CARTON WILL BE LABELED "COMPLIANT TO RoHS DIRECTIVE 2002/95/EC AND ELV ANNEX II OF DIRECTIVE 2000/53/EC". CARTONS WITHOUT THIS LABEL MAY CONTAIN PRODUCT WITH TIN-LEAD IN THE PC TAIL.
 - THESE MODULAR JACKS MEET THE PERFORMANCE REQUIREMENTS OF MOLEX PRODUCT SPECIFICATION PS-42878.
 - CONNECTORS ARE SHIPPED IN THERMOFORMED TRAYS, PER PACKAGING SPECIFICATION PK-42878-492.
 - ALL JACKS ARE DESIGNED TO BE USED WITH .062/(1.57) OR .125/(3.18) THICK P.C. BOARDS.
 - ALL JACKS CONFORM TO AND ACCEPT PLUGS WHICH CONFORM TO FCC RULES AND REGULATIONS PART 68, SUBPART F.
 - ALL JACKS MUST BE CAPABLE OF FITTING INTO MOLEX GAGE G-42410 (CONNECTOR SIZE 4).
 - SEE SHEETS 2 & 4 FOR CONNECTOR SIZE 6.
 - SEE SHEETS 3 & 5 FOR CONNECTOR SIZE 8.
 - ENGRAVED NUMBERS ON HOUSING BODY ARE FOR MOLDING IDENTIFICATION ONLY, THEY ARE NOT INTENDED FOR ASSEMBLY IDENTIFICATION PURPOSES.
 - THIS PART CONFORMS TO CLASS B REQUIREMENTS OF COSMETIC SPECIFICATION PS-45499-002 WITH THE EXCEPTION OF THE SINK WHICH MEETS CLASS C REQUIREMENTS.

P. C. BOARD THICKNESS	DIM. "D" (MTG. PEGS)	DIM. "F" (P.C. TAILS)	CONNECTOR SIZE	CIRCUIT SIZE	DIM. "G"
.062(1.57)	.128 (3.25)	.120 +.015/-.025 (3.05 +.38/- .63)	4	4	.150 (3.81)
.125(3.18)	.191 (4.85)	.205 +.015/-.025 (5.21 +.38/- .63)	4	2	.050 (1.27)

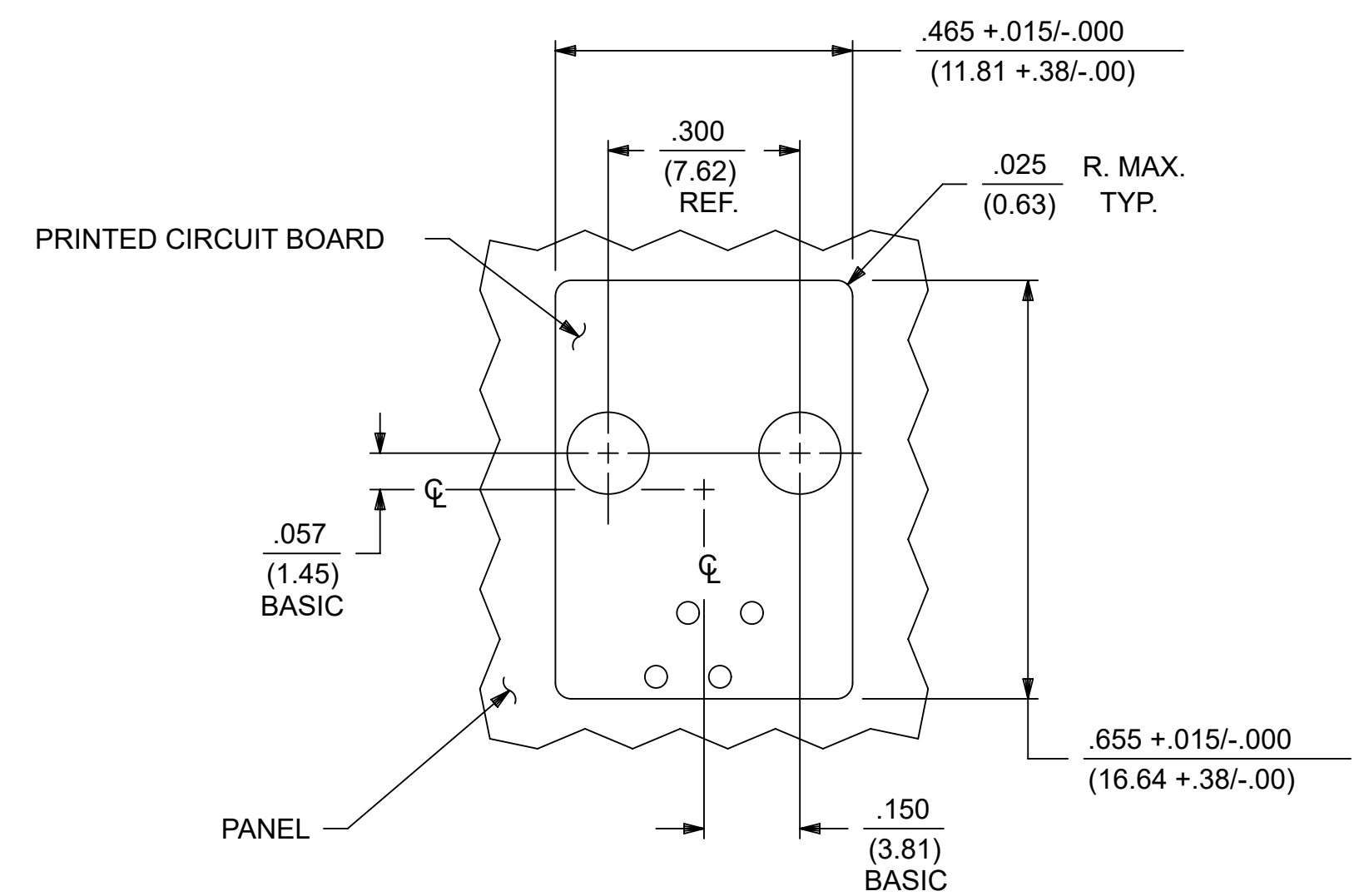
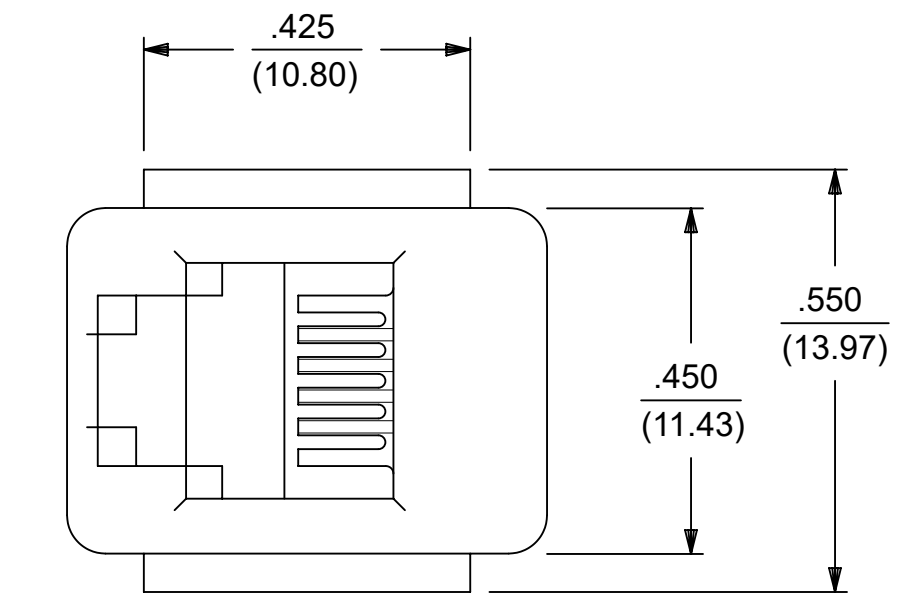

PANEL CUT-OUT FOR CONNECTOR SIZE 4

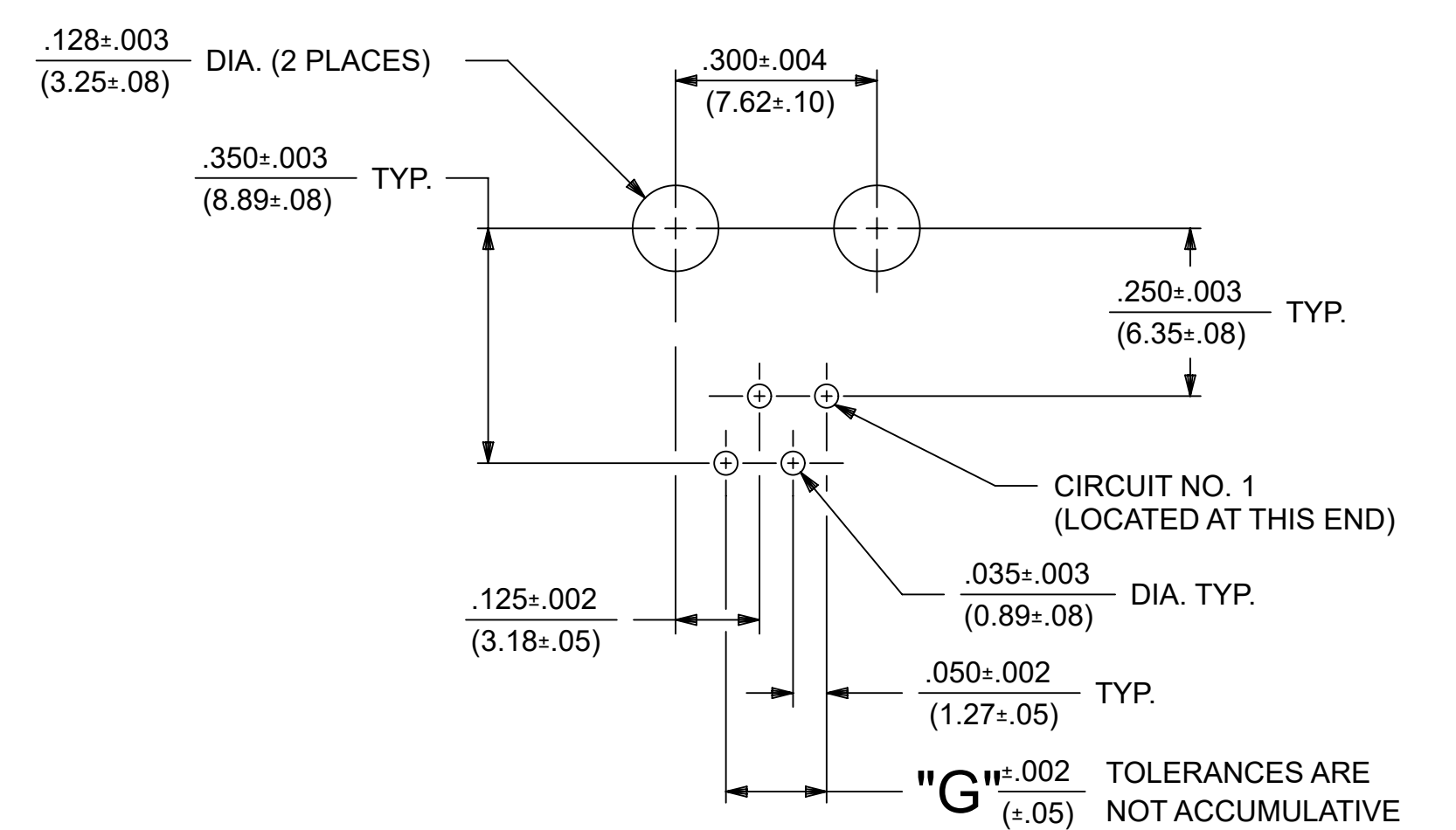

P.C. BOARD LAYOUT FOR CONNECTOR SIZE 4

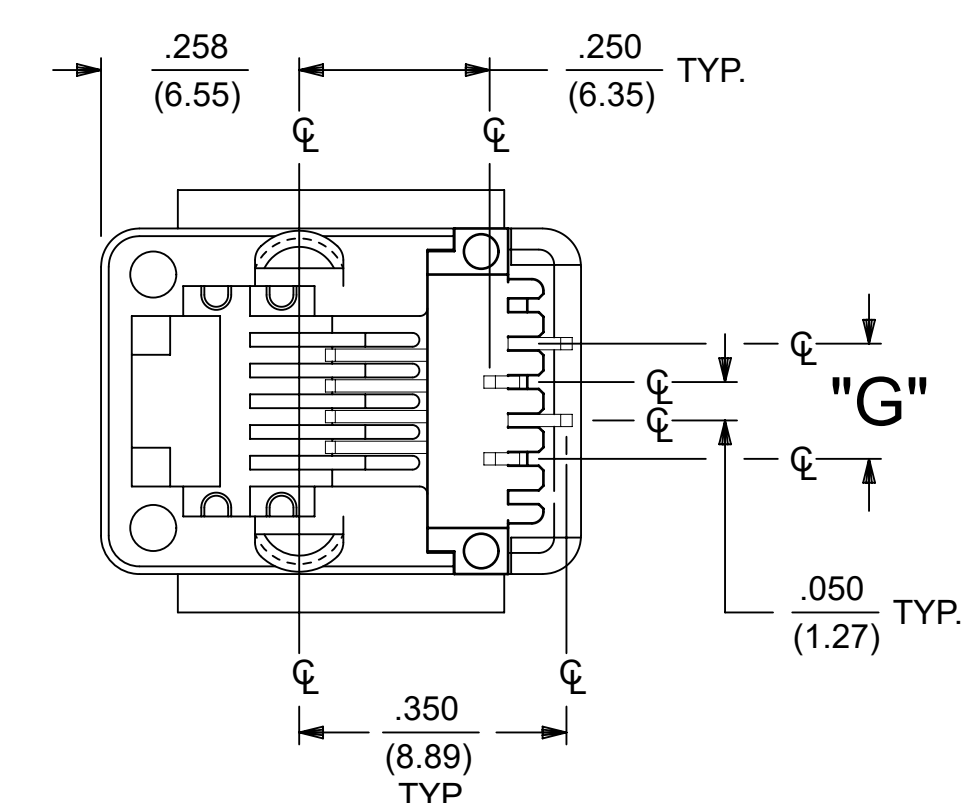
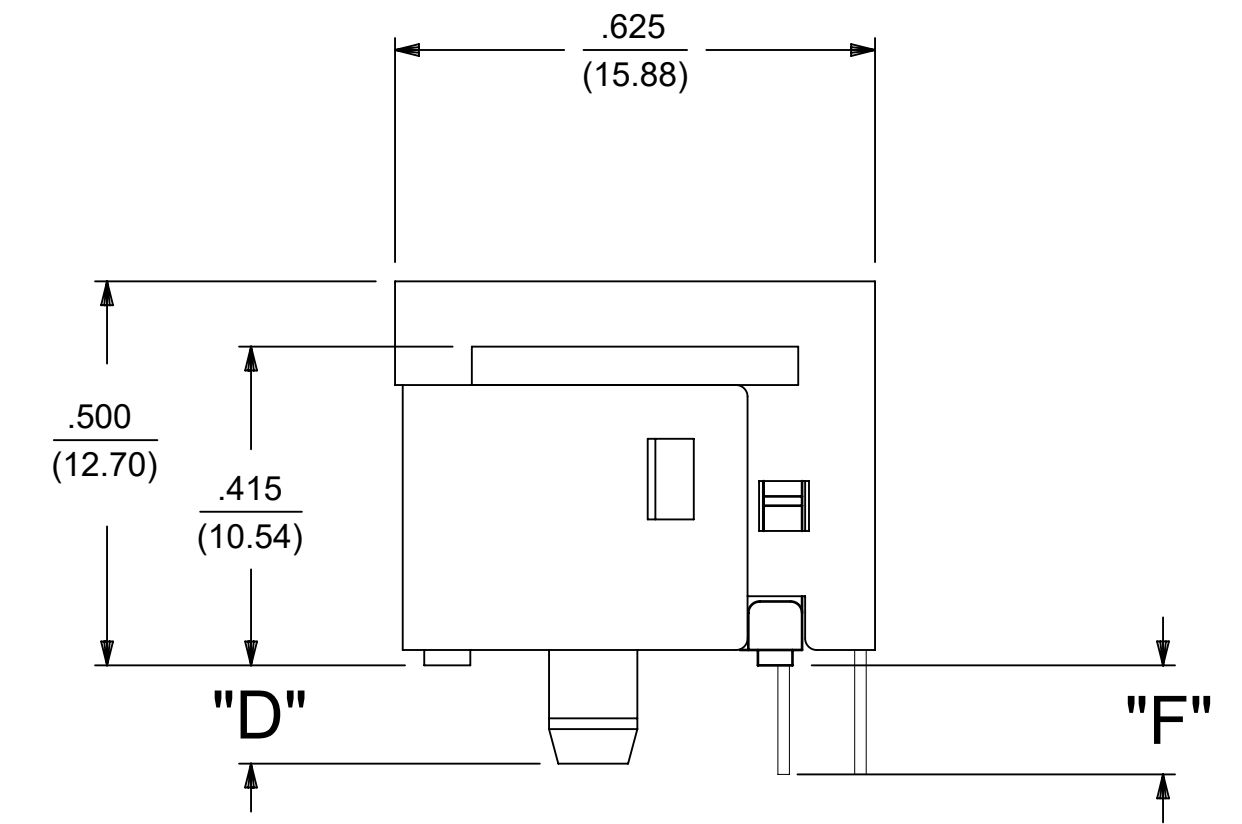
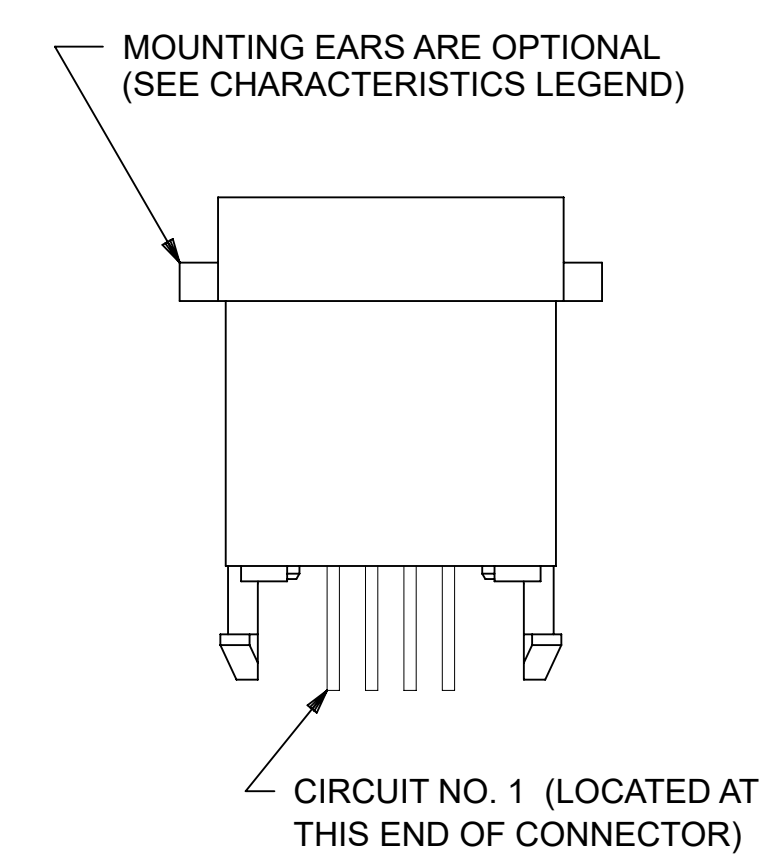

SIZE 4 MODULAR JACK LOADED WITH 4 TERMINALS SHOWN ABOVE

(SEE SHEET 4 FOR PART NUMBER AVAILABILITY)

THIS DRAWING CONTAINS INFORMATION THAT IS PROPRIETARY TO MOLEX ELECTRONIC TECHNOLOGIES, LLC AND SHOULD NOT BE USED WITHOUT WRITTEN PERMISSION					
DIMENSION UNITS	SCALE	CURRENT REV DESC: OBSOLETE PART NUMBER AS PER PCN#509457.			
IN/MM	1:1				
GENERAL TOLERANCES (UNLESS SPECIFIED)					
	MM	INCH			
4 PLACES ±		±			
3 PLACES ±		± 0.01			
2 PLACES ±	0.25	±			
1 PLACE ±		±			
0 PLACES ±		±			
ANGULAR TOL	± 0.5 °				
DRAFT WHERE APPLICABLE MUST REMAIN WITHIN DIMENSIONS		THIRD ANGLE PROJECTION	DRAWING	SERIES	
			D-SIZE	42878	
			MATERIAL NUMBER	CUSTOMER	SHEET NUMBER
			SEE TABLE	GENERAL MARKET	1 OF 5

molex	
ASSEMBLY, VERTICAL LOW PROFILE, MODULAR JACKS (CONNECTOR SIZE 4)	
PRODUCT CUSTOMER DRAWING	
DOCUMENT NUMBER	DOC TYPE DOC PART REVISION
SDA-42878-XXXX	PSD 001 J

5	H
4	H
3	H2
2	H2
1	H2
SH	REV

MODULAR JACK CHARACTERISTICS LEGEND

EXTERNAL CONNECTOR BODY DIMENSIONS: (SEE NOTES 8 AND 9)
 JACKS ARE AVAILABLE IN STANDARD 4, 6, AND 8 POSITION BODY SIZES

NUMBER OF CONTACT POSITIONS:
 CONNECTOR SIZE 4 CAN ACCOMMODATE 2 OR 4 TERMINALS;
 CONNECTOR SIZE 6 CAN ACCOMMODATE 2, 4, OR 6 TERMINALS;
 CONNECTOR SIZE 8 CAN ACCOMMODATE 2, 4, 6, 8, OR 10 TERMINALS

POLARIZATION OPTION:
 "NO"= JACKS WITHOUT KEYING SLOT
 "YES"= JACKS WITH KEYING SLOT (AVAILABLE ON CONNECTOR SIZE 8 ONLY)

MOUNTING EARS OPTION:
 "YES"= JACKS WITH MOUNTING EARS
 "NO"= JACKS WITHOUT MOUNTING EARS

- NOTES:
- 1) MATERIALS: HOUSING- POLYESTER, GLASS FILLED, UL94V-0, COLOR - BLACK
 TERMINALS- PHOSPHOR BRONZE ALLOY, .015/(0.38) THICK.
 - 2) TERMINAL PLATING:
 SELECT GOLD IN CONTACT AREA: 50 MICROINCHES MIN.,
 *SELECT TIN IN PC TAIL AREA: 100 MICROINCHES MIN.,
 WITH OVERALL NICKEL UNDERPLATE: 50 MICROINCHES MIN.
 *THE PRIMARY SHIPPING CARTON WILL BE LABELED "COMPLIANT
 TO RoHS DIRECTIVE 2002/95/EC AND ELV ANNEX II OF DIRECTIVE
 2000/53/EC". CARTONS WITHOUT THIS LABEL MAY CONTAIN
 PRODUCT WITH TIN-LEAD IN THE PC TAIL.
 - 3) THESE MODULAR JACKS MEET THE PERFORMANCE REQUIREMENTS OF MOLEX PRODUCT SPECIFICATION PS-42878.
 - 4) CONNECTORS ARE SHIPPED IN THERMOFORMED TRAYS, PER PACKAGING SPECIFICATION PK-42878-492.
 - 5) ALL JACKS ARE DESIGNED TO BE USED WITH .062/(1.57) OR .125/(3.18) THICK P.C. BOARDS.
 - 6) ALL JACKS CONFORM TO AND ACCEPT PLUGS WHICH CONFORM TO FCC RULES AND REGULATIONS
 PART 68, SUBPART F.
 - 7) ALL JACKS MUST BE CAPABLE OF FITTING INTO MOLEX GAGE G-42410 (CONNECTOR SIZE 8).
 - 8) SEE SHEETS 1 & 4 FOR CONNECTOR SIZE 4.
 - 9) SEE SHEETS 2 & 4 FOR CONNECTOR SIZE 6.
 - 10) ENGRAVED NUMBERS ON HOUSING BODY ARE FOR MOLDING IDENTIFICATION ONLY.
 THEY ARE NOT INTENDED FOR ASSEMBLY IDENTIFICATION PURPOSES.
 - 11) THIS PART CONFORMS TO CLASS B REQUIREMENTS OF COSMETIC SPECIFICATION PS-45499-002
 WITH THE EXCEPTION OF THE SINK WHICH CONFORMS TO CLASS C REQUIREMENTS.

P.C. BOARD THICKNESS	DIM. "D" (MTG. PEGS)	DIM. "F" (P.C. TAILS)
.062/(1.57)	.128 (3.25)	.120 +.015/- .025 (3.05 +.38/- .63)
.125/(3.18)	.191 (4.85)	.205 +.015/- .025 (5.21 +.38/- .63)

CONNECTOR SIZE	CIRCUIT SIZE	DIM. "G"
8	10	.450 (11.43)
8	8	.350 (8.89)
8	6	.250 (6.35)
8	4	.150 (3.81)
8	2	.050 (1.27)

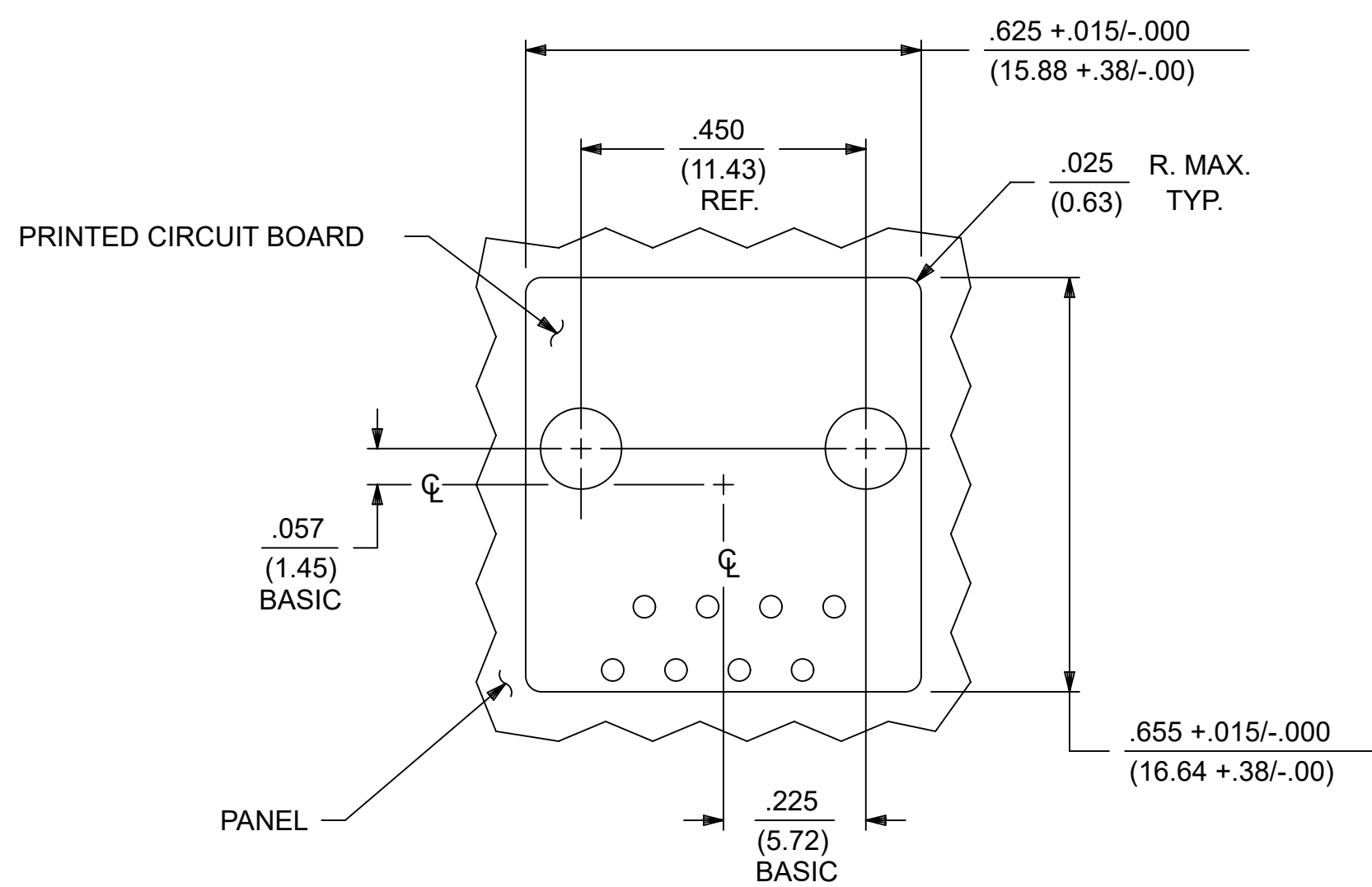
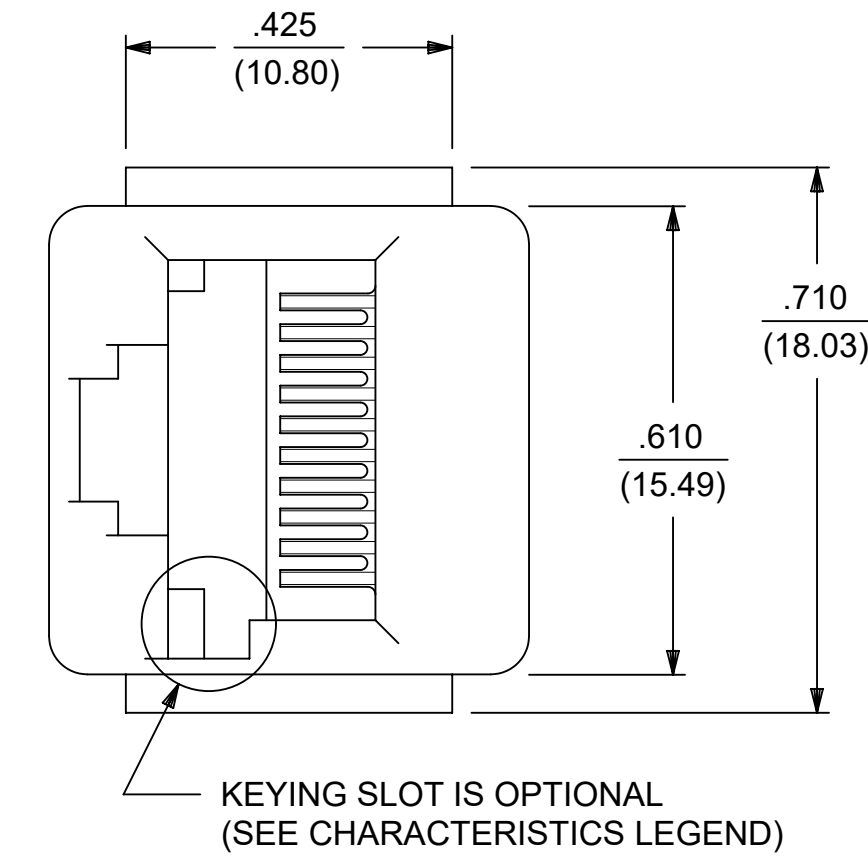

PANEL CUT-OUT FOR CONNECTOR SIZE 8

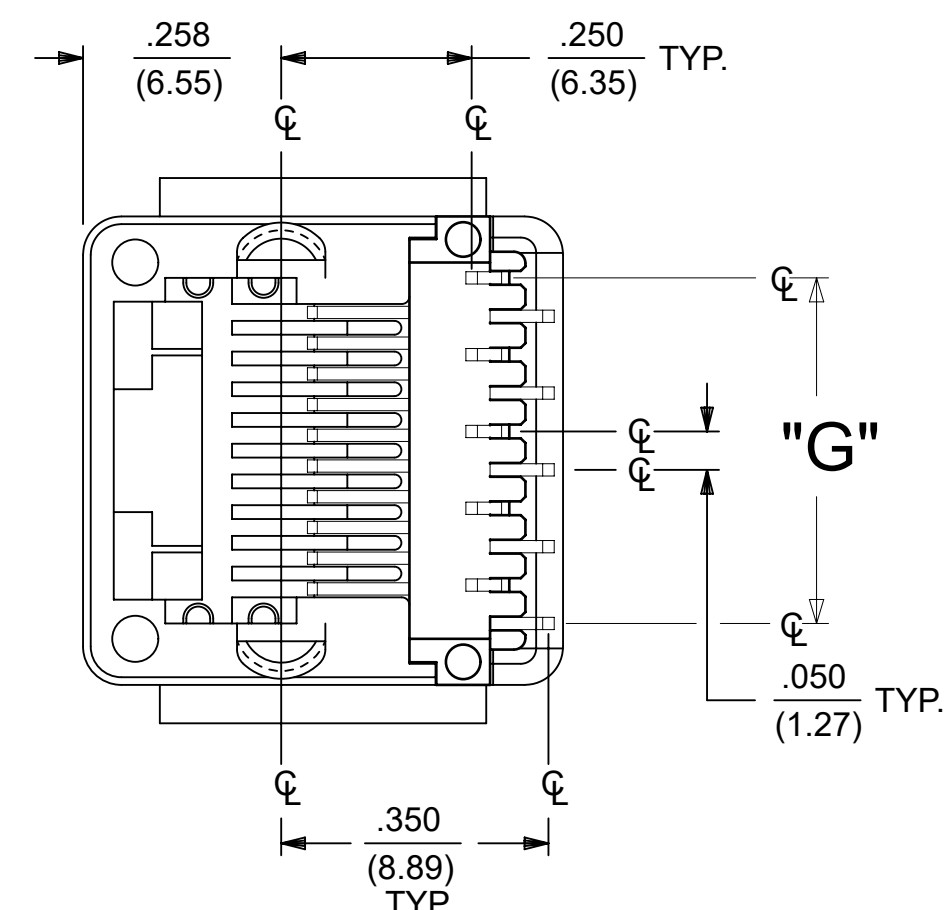
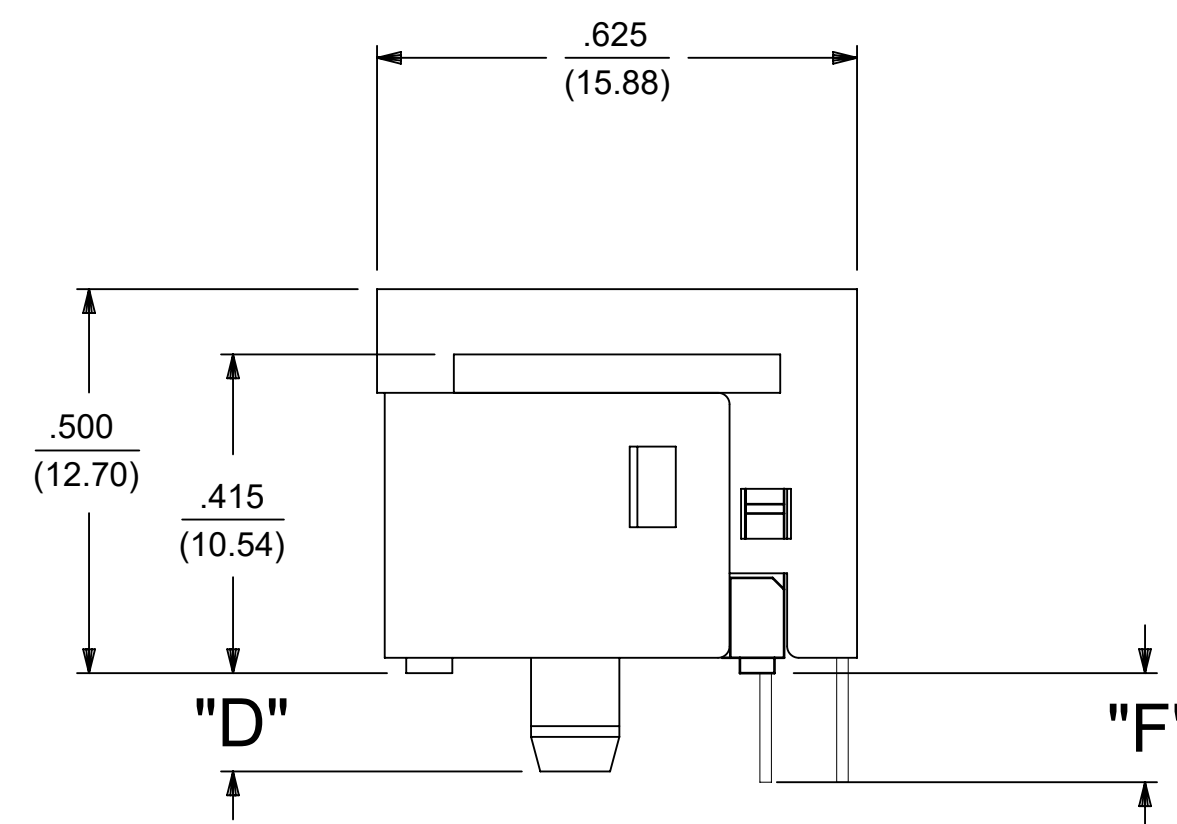
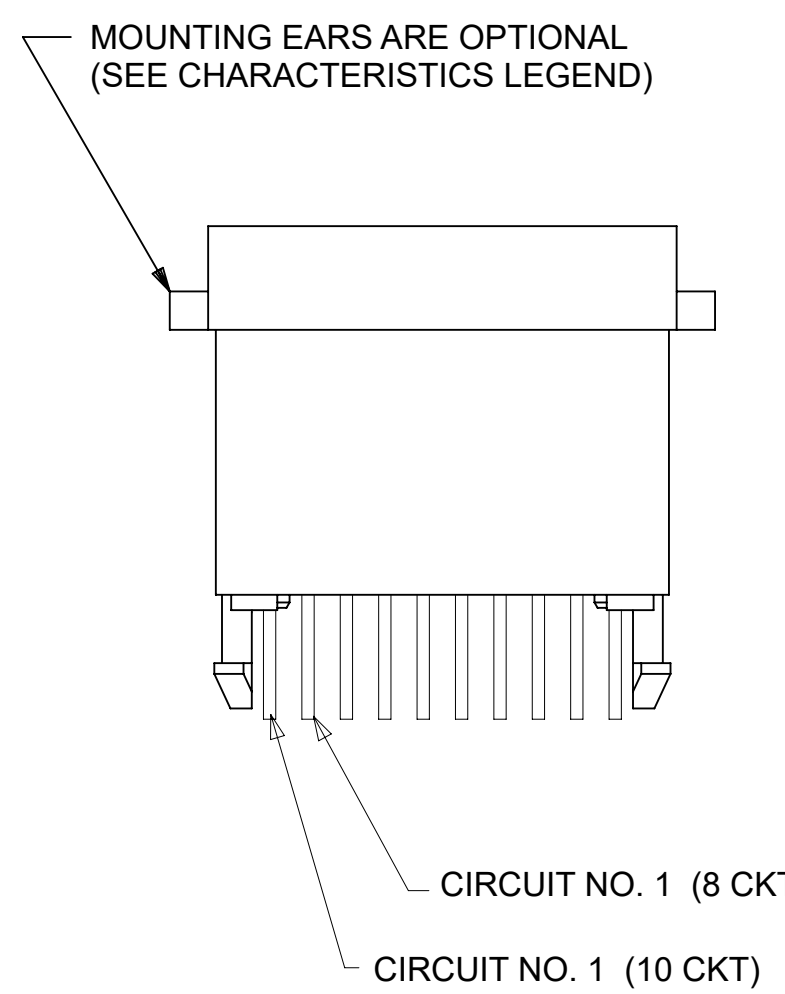

SIZE 8 MODULAR JACK LOADED WITH 10 TERMINALS SHOWN ABOVE

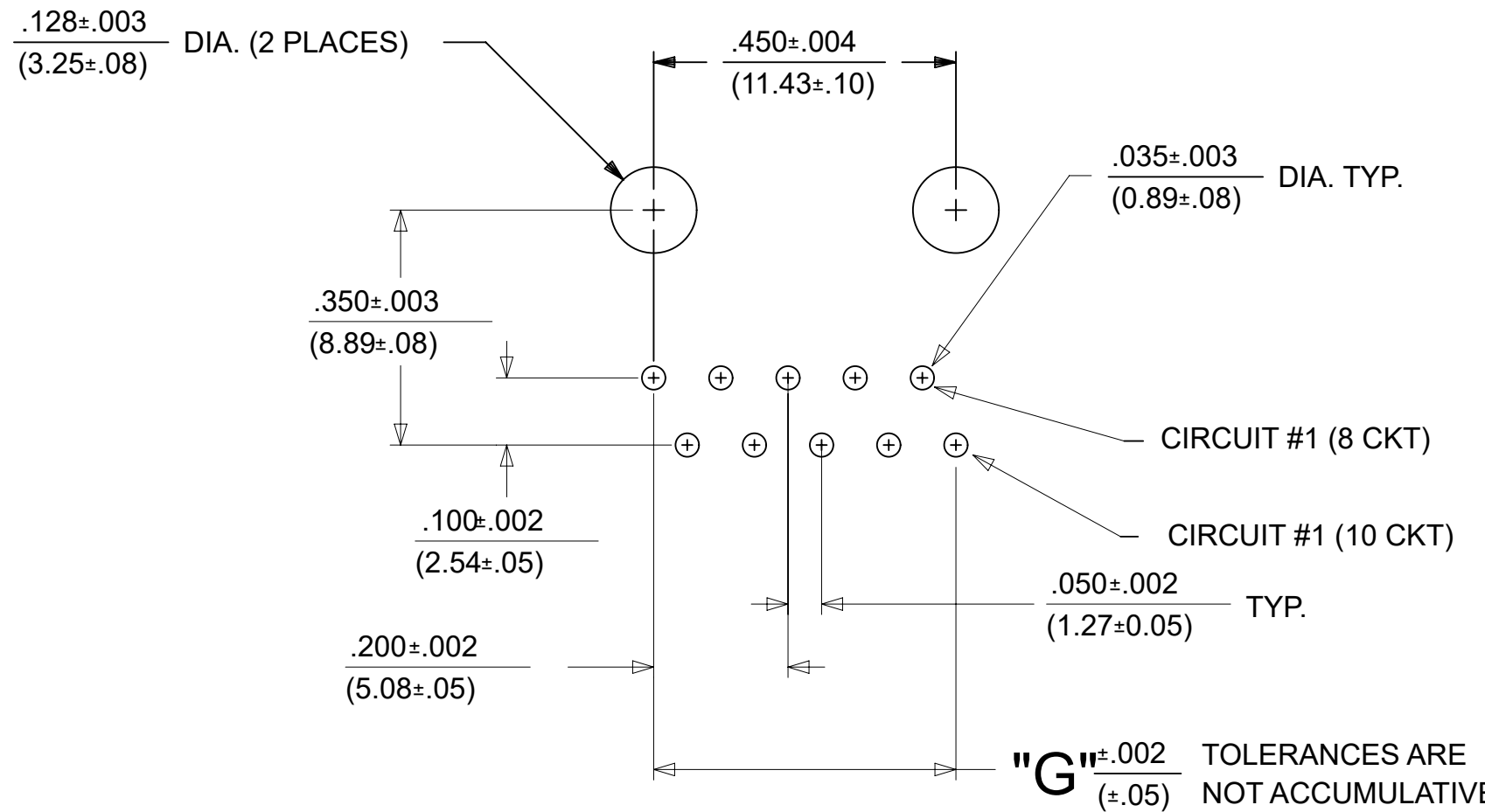

P.C. BOARD LAYOUT FOR CONNECTOR SIZE 8

10 CIRCUIT SHOWN

THIS DRAWING CONTAINS INFORMATION THAT IS PROPRIETARY TO MOLEX ELECTRONIC TECHNOLOGIES, LLC AND SHOULD NOT BE USED WITHOUT WRITTEN PERMISSION		CURRENT REV DESC: OBSOLETE PART NUMBER AS PER PCN#509457.			
DIMENSION UNITS	SCALE	EC NO: 680890			
IN/MM	1:1	DRWN: SANTHN 2021/06/11		ASSEMBLY, VERTICAL LOW PROFILE, MODULAR JACKS (CONNECTOR SIZE 4)	
GENERAL TOLERANCES (UNLESS SPECIFIED)		CHK'D: GGA 2021/11/25		PRODUCT CUSTOMER DRAWING	
4 PLACES	±	APPR: GGA 2021/11/25		DOCUMENT NUMBER	
3 PLACES	±	INITIAL REVISION:		DOC TYPE	
2 PLACES	± 0.25	DRWN: BAP 1990/10/12		DOC PART	
1 PLACE	±	APPR: RAS 1990/10/12		REVISION	
0 PLACES	±	THIRD ANGLE PROJECTION		SDA-42878-XXXX	
ANGULAR TOL ± 0.5 °		DRAWING		PSD 001 J	
DRAFT WHERE APPLICABLE MUST REMAIN WITHIN DIMENSIONS		SERIES		GENERAL MARKET	
		D-SIZE 42878		SHEET NUMBER	
		MATERIAL NUMBER		3 OF 5	
		CUSTOMER			

ASSEMBLY NUMBER	PART CHARACTERISTICS			
	EXTERNAL CONNECTOR SIZE	NUMBER OF POSITIONS	P. C. BOARD THICKNESS	MOUNTING EARS OPTION
42878-4216	4 POS. BODY	4	.062	YES
42878-4218	4 POS. BODY	4	.062	NO

ASSEMBLY ITEM NUMBER	PART CHARACTERISTICS			
	EXTERNAL CONNECTOR SIZE	NUMBER OF POSITIONS	P. C. BOARD THICKNESS	MOUNTING EARS OPTION
42878-6216	6 POS. BODY	6	.062	YES
42878-6218	6 POS. BODY	6	.062	NO
42878-6362	6 POS. BODY	4	.062	NO
42878-6506	6 POS. BODY	2	.062	NO

CHARACTERISTICS LEGEND			
EXTERNAL CONNECTOR BODY DIMENSIONS: AVAILABLE IN 4, 6, AND 8 POSITION BODY			
NUMBER OF CONTACT POSITIONS: CONNECTOR SIZE 4 ACCOMMODATES 2, 4, OR 4 TERMINALS; CONNECTOR SIZE 6 ACCOMMODATES 2, 4, OR 6 TERMINALS; CONNECTOR SIZE 8 ACCOMMODATES 2, 4, 6, 8, OR 10 TERMINALS			
POLARIZATION OPTION: (AVAILABLE ON CONNECTOR SIZE 8 ONLY) "NO"= WITHOUT KEYING SLOT "YES"= WITH KEYING SLOT			
MOUNTING EARS OPTION: "YES"= PART WITH MOUNTING EARS "NO"= PART WITHOUT MOUNTING EARS			

(SEE SHEET 1 & 2 FOR PART DESCRIPTIONS AND DIMENSIONS)

THIS DRAWING CONTAINS INFORMATION THAT IS PROPRIETARY TO MOLEX ELECTRONIC TECHNOLOGIES, LLC AND SHOULD NOT BE USED WITHOUT WRITTEN PERMISSION AS PER PCN#509457.											
DIMENSION UNITS IN/MM		SCALE 1:1		CURRENT REV DESC: OBSOLETE PART NUMBER AS PER PCN#509457.				molex		ASSEMBLY, VERTICAL LOW PROFILE, MODULAR JACKS (CONNECTOR SIZE 4)	
GENERAL TOLERANCES (UNLESS SPECIFIED)				EC NO: 680890		2021/06/11					
		MM	INCH	DRWN: SANTHN		2021/11/25		PRODUCT CUSTOMER DRAWING			
4 PLACES ±		±	±	CHK'D: GGA		2021/11/25					
3 PLACES ±		±	0.01	APPR: GGA		2021/11/25		DOCUMENT NUMBER SDA-42878-XXXX			
2 PLACES ±		0.25	±	INITIAL REVISION:							
1 PLACE ±		±	±	DRWN: BAP		1990/10/12		DOC TYPE PSD		DOC PART 001	
0 PLACES ±		±	±	APPR: RAS		1990/10/12		REVISION J			
ANGULAR TOL ±		0.5 °		THIRD ANGLE PROJECTION		DRAWING D-SIZE		SERIES 42878		MATERIAL NUMBER SEE TABLE	
DRAFT WHERE APPLICABLE MUST REMAIN WITHIN DIMENSIONS				THIRD ANGLE PROJECTION		DRAWING D-SIZE		SERIES 42878		CUSTOMER GENERAL MARKET	
DOCUMENT STATUS P1		RELEASE DATE 2021/11/25 12:18:04		THIRD ANGLE PROJECTION		DRAWING D-SIZE		SERIES 42878		SHEET NUMBER 4 OF 5	

DOCUMENT STATUS	P1	RELEASE DATE	2021/11/25 12:18:04
-----------------	----	--------------	---------------------

ASSEMBLY ITEM NUMBER	PART CHARACTERISTICS				
	EXTERNAL CONNECTOR SIZE	NUMBER OF POSITIONS	P. C. BOARD THICKNESS	POLARIZATION OPTION	MOUNTING EARS OPTION
42878-8408	8 POS. BODY	8	.062	NO	YES
42878-8410	8 POS. BODY	8	.062	NO	NO
42878-8456	8 POS. BODY	8	.062	YES	YES
42878-8458	8 POS. BODY	8	.062	YES	NO
42878-8506	8 POS. BODY	8	.125	NO	NO

ASSEMBLY ITEM NUMBER	PART CHARACTERISTICS				
	EXTERNAL CONNECTOR SIZE	NUMBER OF POSITIONS	BOARD THICKNESS/ P.C. TAIL OPTION	POLARIZATION OPTION	MOUNTING EARS OPTION
42878-9370	8 POS. BODY	2	.125	NO	NO

ASSEMBLY ITEM NUMBER	PART CHARACTERISTICS				
	EXTERNAL CONNECTOR SIZE	NUMBER OF POSITIONS	BOARD THICKNESS/ P.C. TAIL OPTION	POLARIZATION OPTION	MOUNTING EARS OPTION
42878-1003	8 POS. BODY	10	.062	NO	NO

CHARACTERISTICS LEGEND
EXTERNAL CONNECTOR BODY DIMENSIONS: AVAILABLE IN 4, 6, AND 8 POSITION BODY
NUMBER OF CONTACT POSITIONS: CONNECTOR SIZE 4 ACCOMMODATES 2, OR 4 TERMINALS; CONNECTOR SIZE 6 ACCOMMODATES 2, 4, OR 6 TERMINALS; CONNECTOR SIZE 8 ACCOMMODATES 2, 4, 6, 8, OR 10 TERMINALS
POLARIZATION OPTION: (AVAILABLE ON CONNECTOR SIZE 8 ONLY) "NO"= WITHOUT KEYING SLOT "YES"= WITH KEYING SLOT
MOUNTING EARS OPTION: "YES"= PART WITH MOUNTING EARS "NO"= PART WITHOUT MOUNTING EARS

(SEE SHEET 3 FOR PART DESCRIPTIONS AND DIMENSIONS)

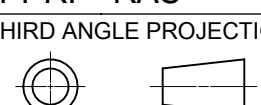
THIS DRAWING CONTAINS INFORMATION THAT IS PROPRIETARY TO MOLEX ELECTRONIC TECHNOLOGIES, LLC AND SHOULD NOT BE USED WITHOUT WRITTEN PERMISSION										
DIMENSION UNITS	SCALE	CURRENT REV DESC: OBSOLETE PART NUMBER AS PER PCN#509457.								
IN/MM	1:1									
GENERAL TOLERANCES (UNLESS SPECIFIED)					ASSEMBLY, VERTICAL LOW PROFILE, MODULAR JACKS (CONNECTOR SIZE 4)					
	MM	INCH				PRODUCT CUSTOMER DRAWING				
4 PLACES	±	±				DOCUMENT NUMBER				
3 PLACES	±	± 0.01				DOC TYPE				
2 PLACES	±	0.25				DOC PART				
1 PLACE	±	±				REVISION				
0 PLACES	±	±				SDA-42878-XXXX				
ANGULAR TOL	±	0.5 °				PSD				
DRAFT WHERE APPLICABLE MUST REMAIN WITHIN DIMENSIONS		THIRD ANGLE PROJECTION		DRAWING	SERIES	MATERIAL NUMBER		CUSTOMER		SHEET NUMBER
				D-SIZE	42878	SEE TABLE		GENERAL MARKET		5 OF 5