

53240-1 ✓ ACTIVE

PLASTI-GRIP

TE Internal #: 53240-1

Spring Spade Terminal, 22 AWG, #6 / M3.5 Stud Size, 3.56 mm [.14 in] Stud Diameter, Closed Barrel, Straight, Tin, Partially Insulated, PLASTI-GRIP

[View on TE.com >](#)



Terminals & Splices > Spade Terminals

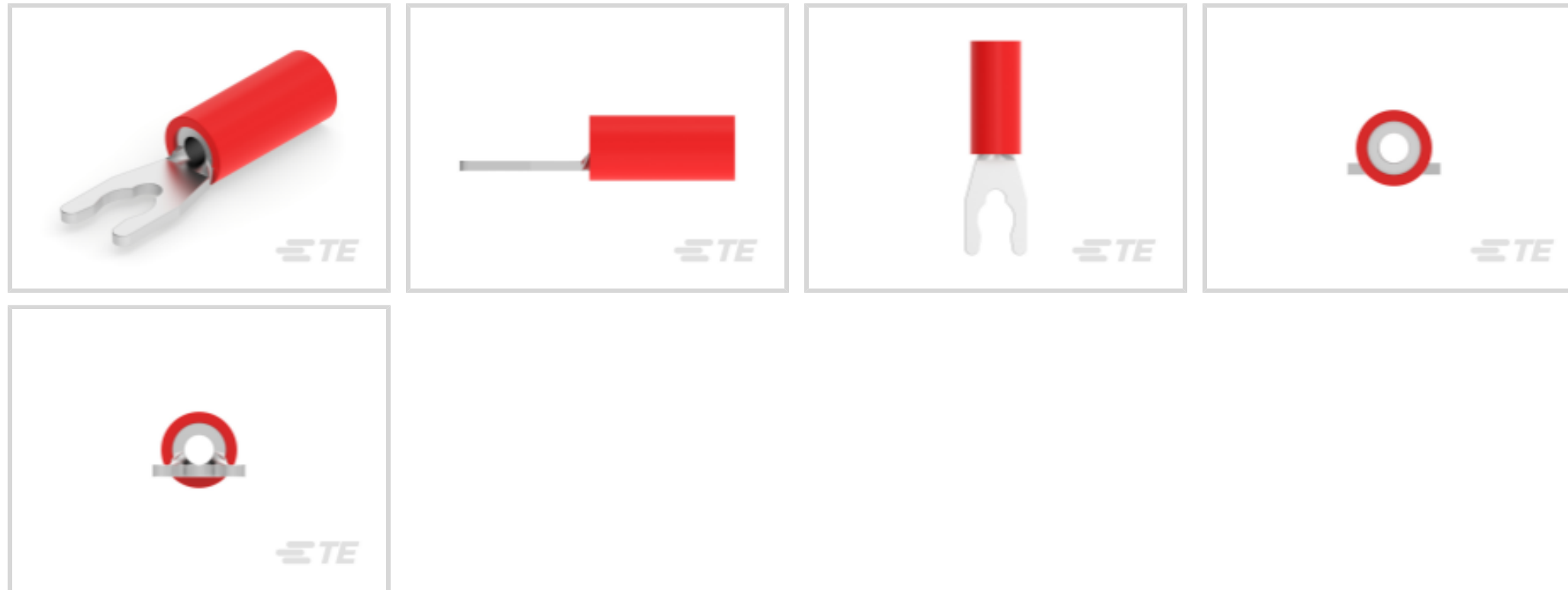

Spade Terminal Type: **Spring Spade Terminal**

Wire Size: **509 – 3260 CMA**

Stud Size: **#6, M3.5**

Features

Product Type Features

Stud Size	#6, M3.5
Sealable	No
Wire Insulation Support Retention Type	Insulation Support

Electrical Characteristics

Voltage Rating	600 V
----------------	-------

Body Features

Insulation Sleeve Color	Red
Stripe Color	Red

Contact Features

Spade Terminal Type	Spring Spade Terminal
Barrel Type	Closed
Terminal Orientation	Straight
Terminal Plating Material	Tin

Mechanical Attachment

Wire Insulation Support	With
-------------------------	------



Dimensions

Wire Size	509 – 3260 CMA
Stud Diameter	3.56 mm [.14 in]
Tongue Thickness	.79 mm [.031 in]
Product Length	20.6 mm [.811 in]
Compatible Insulation Diameter (Max)	3.56 mm [.14 in]
Compatible Insulation Diameter Range	2.67 – 3.56 mm [.105 – .14 in]

Usage Conditions

Insulation Option	Partially Insulated
Operating Temperature Range	105 °C [221 °F]

Operation/Application

Compatible With Wire Base Material	Copper
Compatible With Wire Plating Material	Tin

Industry Standards

Government Qualified Terminal	No
-------------------------------	----

Packaging Features

Packaging Quantity	1000
Packaging Method	Loose Piece

Product Compliance

[For compliance documentation, visit the product page on TE.com>](#)

EU RoHS Directive 2011/65/EU	Compliant
EU ELV Directive 2000/53/EC	Compliant
China RoHS 2 Directive MIIT Order No 32, 2016	No Restricted Materials Above Threshold
EU REACH Regulation (EC) No. 1907/2006	Current ECHA Candidate List: JUNE 2024 (241) Candidate List Declared Against: JUNE 2024 (241) Does not contain REACH SVHC
Halogen Content	Not Low Halogen - contains Br or Cl > 900 ppm.
Solder Process Capability	Not applicable for solder process capability

Product Compliance Disclaimer

This information is provided based on reasonable inquiry of our suppliers and represents our current actual knowledge based on the information they provided. This information is subject to change. The part numbers that TE has identified as EU RoHS compliant have a maximum concentration of 0.1% by weight in homogenous materials for lead, hexavalent chromium, mercury, PBB, PBDE, DBP, BBP, DEHP, DIBP, and 0.01% for cadmium, or qualify for an exemption to these limits as defined in the Annexes of Directive 2011/65/EU (RoHS2). Finished electrical and electronic equipment products will be CE marked as required by Directive 2011/65/EU. Components may not be CE marked. Additionally, the part numbers that TE has identified as EU ELV compliant have a maximum concentration of 0.1% by weight in homogenous materials for lead, hexavalent chromium, and mercury, and 0.01% for cadmium, or qualify for an exemption to these limits as defined in the Annexes of Directive 2000/53/EC (ELV). Regarding the REACH Regulation, the information TE provides on SVHC in articles for this part number is based on the latest European Chemicals Agency (ECHA) 'Guidance on requirements for substances in articles' posted at this URL: <https://echa.europa.eu/guidance-documents/guidance-on-reach>

Compatible Parts

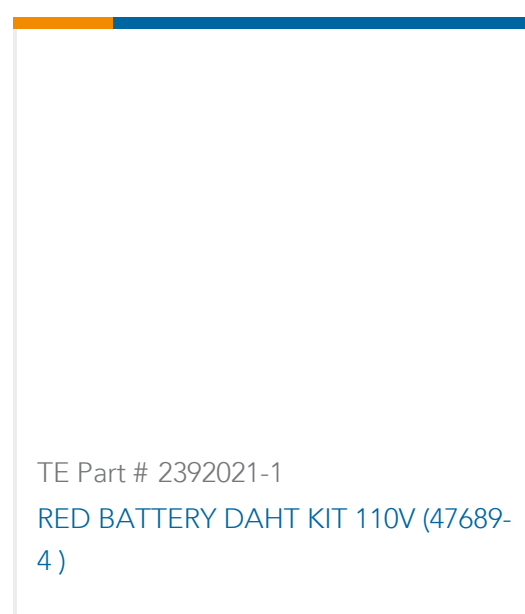
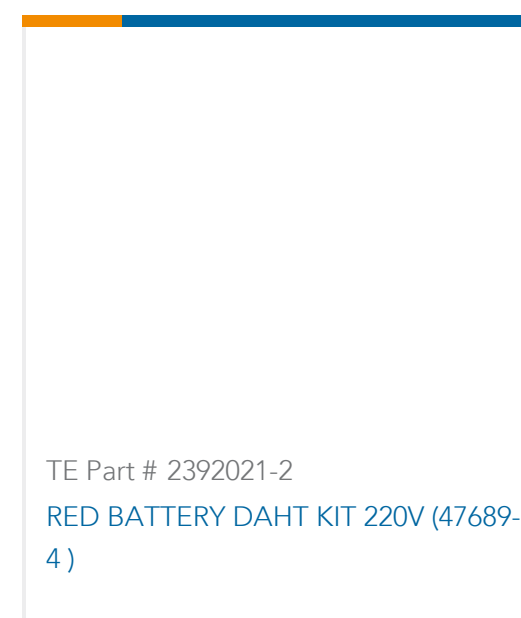

Also in the Series | PLASTI-GRIP



Compression Connectors(3)



Crimp Wire Pins, Tabs & Ferrules(19)



Ring Terminals(300)

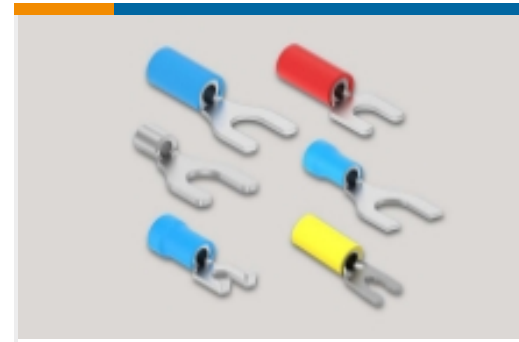

Spade Terminals(160)



Splices(46)

Customers Also Bought



TE Part #1658614-4
09 POS HDF RCPT, AP, LEAD FREE

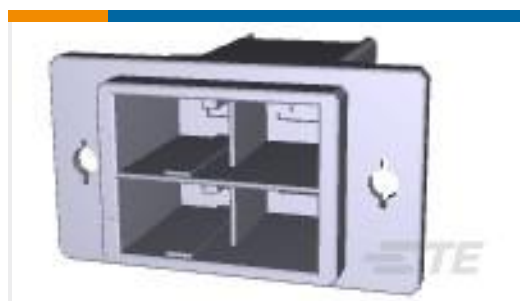

TE Part #1-917809-2
DYNAMIC D-5 TAB HSG D/R 4P X-X



TE Part #7-6609107-2
PS0S0DS6B=C1185



TE Part #36932
BODY SOLIS RING 4/0 3/8



TE Part #1658621-5
24 NOVO MIL/CTR 15DP, LEAD FREE

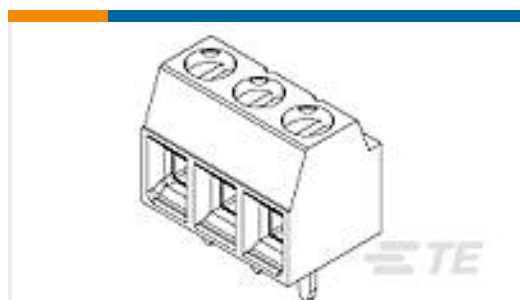

TE Part #1776113-2
2P, 3.81MM, SIDE ENTRY, HIGH TMP



TE Part #NB17372001
RP-4800-NO.2-0-STK



TE Part #2383938-2
TERMI-BLOK SMD MOUNT 180_2P_5 MM

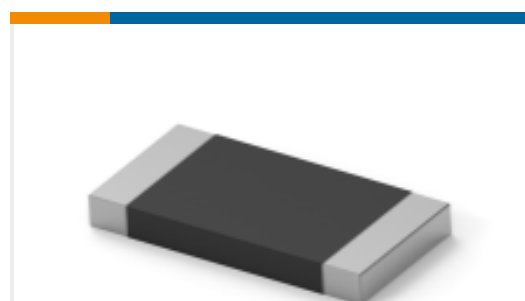

TE Part #5-2176422-2
TLRP 2512 3.0W R008 1% 50PPM 4K RL



Documents

Product Drawings

[PG SP SPD 22-16COMM22-18MIL 6](#)

English

CAD Files

Customer View Model

[ENG_CVM_53240-1_F.3d_igs.zip](#)

English

Customer View Model

[ENG_CVM_53240-1_F.3d_stp.zip](#)

English

Customer View Model

[ENG_CVM_53240-1_F.2d_dxf.zip](#)

English

[3D PDF](#)

English

By downloading the CAD file I accept and agree to the [Terms and Conditions](#) of use.

Product Specifications

[Application Specification](#)

English

Agency Approvals

[UL Report](#)

English

[UL Report](#)

English