

R Series

High-Density
0.075"
(1.905mm)

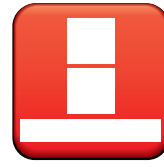
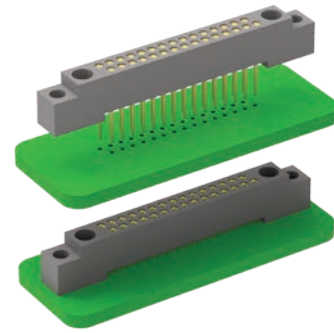

RM – Two-Row, Straight, Stackable, Board-Mount Receptacle

Contact Spacing: 0.075" (1.91 mm)

R-Series products are high-density, plastic connectors commonly used in board-to-board applications. Approved to MIL-55302 standard.

Sample Part Number Format: RM22-030-531-0256

RM	2		2				0256
SERIES 0.075" Plastic Rectangular Connector (Receptacle)	ROWS 2 – 2-Row (10-100 contacts)	STYLE 2 – Receptacle, straight with mounting ears 4 – Receptacle, straight without mounting ears	BODY MATERIAL 2 – Polyphenylene sulfide (PPS)	SIZE 010 – 10 contacts 020 – 20 contacts 030 – 30 contacts 040 – 40 contacts 050 – 50 contacts 060 – 60 contacts 070 – 70 contacts 080 – 80 contacts 090 – 90 contacts 100 – 100 contacts	PLATING 1 – Gold 2 – Pre-tinned, SnPb alloy (Plated thru-hole options, only) ‡ 3 – Pre-tinned, SAC305 alloy (Plated thru-hole options, only)	TERMINATION 53 – Stackable, 0.212" x 0.025" Ø 54 – Stackable, 0.244" x 0.025" Ø 55 – Stackable, 0.275" x 0.025" Ø	HARDWARE 0256 – None

Notes:
‡ Not RoHS-compliant

PLEASE CONSULT THE AIRBORN WEBSITE FOR THE LATEST REVISION OF THIS DOCUMENT PRIOR TO BEGINNING ANY DESIGN WORK.

Mates with

- RM212 & RM232 — Two-row, straight plug
- RM252 & RM272 — Two-row, right-angle plug
- RM2 — Two-row, I/O receptacle
- RA2 — Two-row, I/O receptacle

Terminations



RM – Two-Row, Straight, Stackable, Board-Mount Receptacle

Plastic ▪ 2-Row ▪ 10-100 Contacts

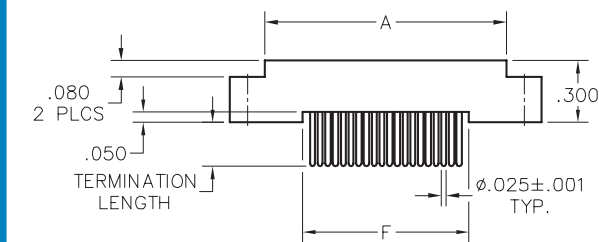

DIMENSIONS						
SIZE	A	B	C	D	E	F
10	.797	.617	.300	.967	1.137	.420
20	1.172	.992	.675	1.342	1.512	.795
30	1.547	1.367	1.050	1.717	1.887	1.170
40	1.922	1.742	1.425	2.092	2.262	1.545
50	2.297	2.117	1.800	2.467	2.637	1.920
60	2.672	2.492	2.175	2.842	3.012	2.295
70	3.047	2.867	2.550	3.217	3.387	2.670
80	3.422	3.242	2.925	3.592	3.762	3.045
90	3.797	3.617	3.300	3.967	4.137	3.420
100	4.172	3.992	3.675	4.342	4.512	3.795

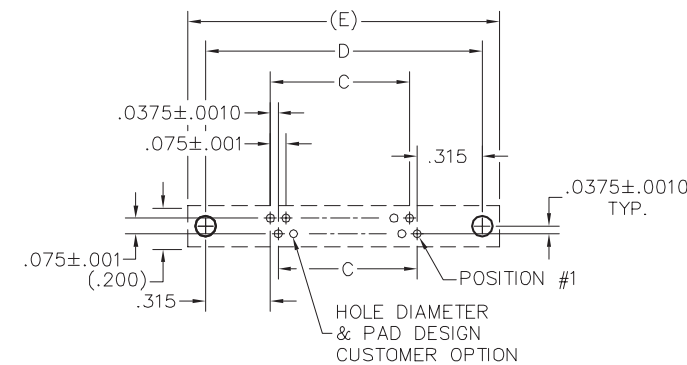
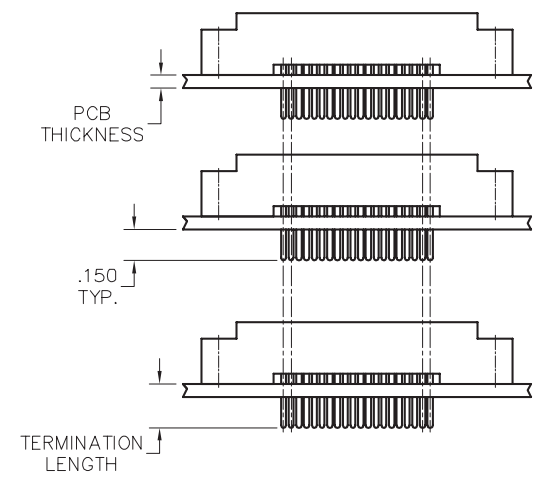
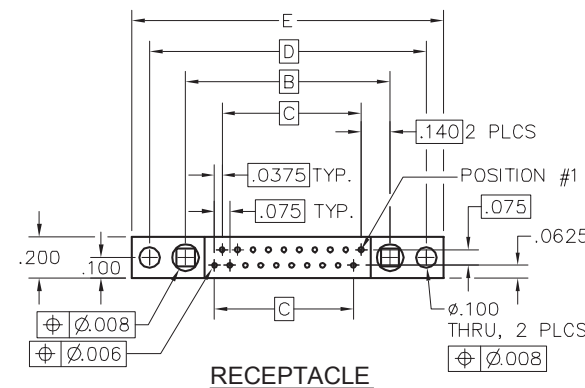

PCB LAYOUT VIEWED FROM COMPONENT SIDE

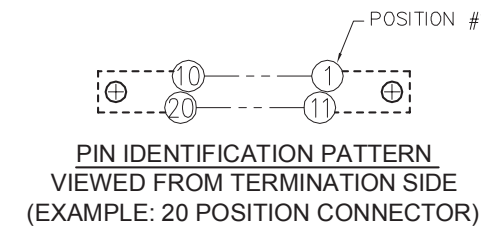

PIN IDENTIFICATION PATTERN VIEWED FROM TERMINATION SIDE (EXAMPLE: 20 POSITION CONNECTOR)

NOTES:
Stacking connectors cannot have mating hardware. (-0256 indicates no hardware)

PC BOARD THICKNESS	TERMINATION LENGTH	PART NUMBER EXAMPLES
.062	.212	RM222-020-531-0256
.094	.244	RM222-020-541-0256
.125	.275	RM222-020-551-0256
CONNECTOR SAVER	.150	RM222-020-291-0256

PLEASE CONSULT THE AIRBORN WEBSITE FOR THE LATEST REVISION OF THIS DOCUMENT PRIOR TO BEGINNING ANY DESIGN WORK.

Mouser Electronics

Authorized Distributor

Click to View Pricing, Inventory, Delivery & Lifecycle Information:

[AirBorn:](#)

[RM242-010-551-0256](#) [RM242-020-531-0256](#) [RM222-030-531-0256](#) [RM222-010-531-0256](#) [RM222-020-531-0256](#)