

Metallized Polyester Film Capacitors MKT Radial Epoxy Lacquered Type

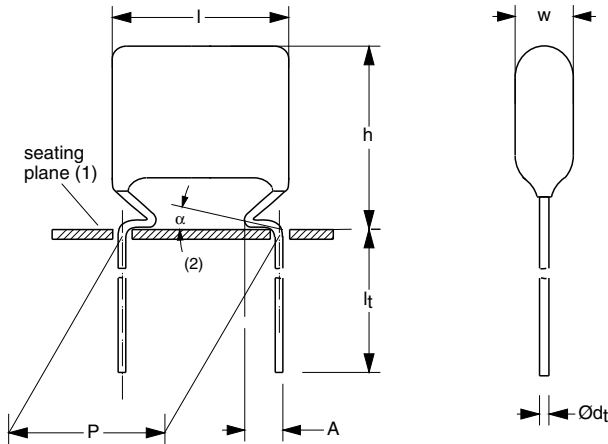

Dimensions in mm

- (1) Hole \varnothing 1.0 for $d_t = 0.6$ mm
Hole \varnothing 1.3 for $d_t = 0.8$ mm
- (2) $0 \leq \alpha < 50^\circ$
- (3) $A = 2.0 + 1.0/-0.5$ mm (pitch = 10.0 mm)
 $A = 2.5 + 1.4/-0.5$ mm (pitch = 15.0 mm, 22.5 mm and 27.5 mm)

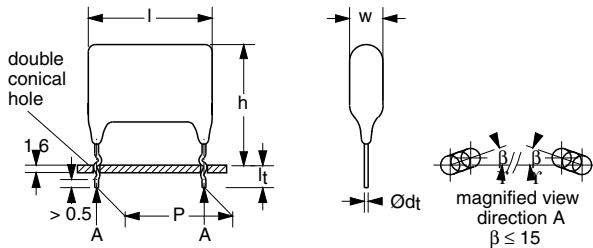

Dimensions in mm

APPLICATIONS

Blocking and coupling. Bypass and energy reservoir

MARKING

C-value; tolerance; rated voltage

DIELECTRIC

Polyester film

ELECTRODES

Vacuum deposited aluminum

FEATURES

Available taped on reel and loose in box

- Material categorization:
for definitions of compliance please see
www.vishay.com/doc?99912



RoHS
COMPLIANT

COATING

Flame retardant epoxy material (UL-class 94 V-0)

CONSTRUCTION

Wound mono construction

LEADS

Tinned wire

CAPACITANCE RANGE (E12 SERIES)

0.001 to 1.0 μ F

CAPACITANCE TOLERANCE

$\pm 10\%$; $\pm 5\%$

RATED (DC) VOLTAGE

63 V; 100 V; 250 V; 400 V; 630 V

RATED (AC) VOLTAGE

40 V; 63 V; 160 V; 220 V; 250 V

CLIMATIC CATEGORY

55/105/56

RATED TEMPERATURE

85 $^\circ$ C

MAXIMUM APPLICATION TEMPERATURE

105 $^\circ$ C

REFERENCE SPECIFICATIONS

IEC 60384-2

PERFORMANCE GRADE

Grade 1 (long life)

DETAIL SPECIFICATION

For more detailed data and test requirements see "Type detail specification HQN-384-02/101"

COMPOSITION OF CATALOG NUMBER

368	10.0 mm
	15.0 mm
	22.5 mm
	27.5 mm

numerically

0.1	2
1	3
10	4
100	5

 Example:
 $104 = 10 \times 10 = 100 \text{ nF}$

000	368	XX	XX	X
000	368	XX	XX	X

* Use this partnumber for those with access to the Vishay's SAP system and Partners web-site within the Americas

TYPE	ENCLOSING	LEAD CONFIGURATION	ON REQUEST					
			±10 %	±5 %	±10 %	±5 %	±10 %	
368	loose in box	lead length $4.0 + 1.0/-0.5 \text{ mm}$	± 10 %	15	25	45	55	65
			± 5 %	16	26	46	56	66
		lead length $4.0 + 1.0/-0.5 \text{ mm}$ (lock lead)	± 10 %	-	90	90	90	90
		dimensions of this code numbers stays between brackets						
		lead length $3.5 \pm 0.5 \text{ mm}$	± 10 %	13	23	43	53	63
			± 5 %	17	27	47	57	67
		long leads: $19.0 \pm 4.0 \text{ mm}$ for lead pitch = 15.0 mm $25.0 \pm 4.0 \text{ mm}$ for lead pitch = 22.5 mm $24.0 \pm 4.0 \text{ mm}$ for lead pitch = 27.5 mm	± 10 %	11	21	41	51	61
			± 5 %	12	22	42	52	62
	taped on reel	H = 16.0 mm; P ₀ = 12.7 mm; reel diameter = 500 mm	± 10 %	18	28	48	58	68
			± 5 %	19	29	49	59	69

SPECIFIC REFERENCE DATA

DESCRIPTION	VALUE				
	at 1 kHz	at 10 kHz	at 100 kHz		
Tangent of loss angle:					
$C \leq 0.1 \mu\text{F}$	$\leq 75 \times 10^{-4}$	$\leq 130 \times 10^{-4}$	$\leq 225 \times 10^{-4}$		
$0.1 \mu\text{F} < C \leq 0.47 \mu\text{F}$	$\leq 75 \times 10^{-4}$	$\leq 130 \times 10^{-4}$	$\leq 300 \times 10^{-4}$		
$0.47 \mu\text{F} < C \leq 1.0 \mu\text{F}$	$\leq 75 \times 10^{-4}$	$\leq 130 \times 10^{-4}$	-		
Rated voltage pulse slope $(dU/dt)_R$	at 63 V (DC)	at 100 V (DC)	at 250 V (DC)	at 400 V (DC)	at 630 V (DC)
P = 10 mm	30 V/μs	30 V/μs	70 V/μs	110 V/μs	70 V/μs
P = 15 mm		20 V/μs	28 V/μs	44 V/μs	70 V/μs
P = 22.5 mm		8 V/μs	12 V/μs	20 V/μs	28 V/μs
P = 27.5 mm		7 V/μs	10 V/μs	16 V/μs	24 V/μs
R between leads, for $C \leq 0.33 \mu\text{F}$:					
at 10 V; 1 minute	> 15000 MΩ				
at 100 V; 1 minute		> 15000 MΩ	> 30000 MΩ	> 30000 MΩ	
at 500 V; 1 minute					> 30000 MΩ
RC between leads, for $C > 0.33 \mu\text{F}$:					
at 10 V; 1 minute	> 5000 s				
at 100 V; 1 minute		> 5000 s	> 10000 s	> 10000 s	
at 500 V; 1 minute					> 10000 s
R between interconnecting leads and casing;					
at 10 V; 1 minute	> 30000 MΩ				
at 100 V; 1 minute		> 30000 MΩ	> 30000 MΩ	> 30000 MΩ	
at 500 V; 1 minute					> 30000 MΩ
Withstanding (DC) voltage (cut off current 10 mA); rise time 100 V/s	100 V; 1 minute	160 V; 1 minute	400 V; 1 minute	640 V; 1 minute	1008 V; 1 minute
Withstanding (DC) voltage between leads and case	200 V; 1 minute	200 V; 1 minute	500 V; 1 minute	800 V; 1 minute	1260 V; 1 minute



$U_{Rdc} = 63 \text{ V}$; $U_{Rac} = 40 \text{ V}$

C (μF)	DIMENSIONS $w_{\text{max}} \times h_{\text{max}} \times l_{\text{max}}$ (mm)	MASS (g)	CATALOG NUMBER 2222 368 AND PACKAGING					
			LOOSE IN BOX			REEL	LOOSE IN BOX	
			$l_t =$ 4.0 + 1.0/-0.5 mm	short leads	long leads	SPQ	$l_t =$ 4.0 + 1.0/-0.5 mm	SPQ
			C-tol = $\pm 10 \%$	SPQ	SPQ		C-tol = $\pm 10 \%$	
last 5 digits of catalog number	last 5 digits of catalog number							
Pitch = 10.0 \pm 0.4 mm; $d_t = 0.60 \pm 0.06$ mm					lock lead			
0.22	4.2 x 13.2 (15.5) x 12.5	0.5	15224	2000	1000	1300	90316	1100
0.27	4.0 x 12.8 (15.5) x 12.5	0.5	15274	2000	1000	1300	90317	1100
0.33	4.3 x 13.1 (15.5) x 12.5	0.5	15334	2000	1000	1300	90318	1100
0.39	4.2 x 12.9 (15.5) x 12.5	0.5	15394	2000	1000	1300	90319	1100
0.47	4.3 x 13.4 (16.0) x 12.5	0.5	15474	2000	1000	1200	90321	1000
0.56	4.7 x 13.7 (16.0) x 12.5	0.5	15564	2000	1000	1200	90322	1000
0.68	5.1 x 14.1 (16.5) x 12.5	0.6	15684	2000	1000	1100	90323	1500
0.82	5.5 x 14.5 (17.0) x 12.5	0.6	15824	2000	1000	1000	90324	1250
1.0	6.0 x 15.0 (17.5) x 12.5	0.8	15105	2000	1000	900	90325	1250

$U_{Rdc} = 100 \text{ V}$; $U_{Rac} = 63 \text{ V}$

C (μF)	DIMENSIONS $w_{\text{max}} \times h_{\text{max}} \times l_{\text{max}}$ (mm)	MASS (g)	CATALOG NUMBER 2222 368 AND PACKAGING					
			LOOSE IN BOX			REEL	LOOSE IN BOX	
			$l_t =$ 4.0 + 1.0/- 0.5 mm	short leads	long leads	SPQ	$l_t =$ 4.0 + 1.0/-0.5 mm	SPQ
			C-tol = $\pm 10 \%$	SPQ	SPQ		C-tol = $\pm 10 \%$	
last 5 digits of catalog number	last 5 digits of catalog number							
Pitch = 10.0 \pm 0.4 mm; $d_t = 0.60 \pm 0.06$ mm					lock lead			
0.056	4.0 x 13.0 (15.0) x 12.5	0.4	25563	2000	1000	1500	90205	1250
0.068			25683				90206	
0.082	3.7 x 12.7 (15.0) x 12.5	0.4	25823	2000	1000	1500	90207	1250
0.10	4.0 x 13.0 (15.0) x 12.5	0.4	25104	2000	1000	1500	90208	1250
0.12	4.3 x 13.3 (15.0) x 12.5	0.4	25124	2000	1000	1500	90209	1250
0.15	3.9 x 12.9 (15.0) x 12.5	0.4	25154	2000	1000	1500	90211	1250
0.18	4.2 x 13.2 (15.5) x 12.5	0.5	25184	2000	1000	1300	90212	1100
0.22	4.5 x 13.6 (16.0) x 12.5	0.5	25224	2000	1000	1200	90213	1000
Pitch = 15.0 \pm 0.4 mm; $d_t = 0.80 \pm 0.08$ mm					lock lead			
0.27	5.0 x 14.0 (17.0) x 17.5	0.6	25274	2000	1000	1200	90214	1750
0.33			25334				90215	
0.39			25394				90216	
0.47	5.5 x 14.5 (17.5) x 17.5	0.7	25474	2000	1000	1100	90217	1500
0.56			25564				90218	
0.68	6.0 x 15.0 (18.0) x 17.5	0.9	25684	2000	1000	1000	90219	1500
0.82	6.5 x 15.5 (18.5) x 17.5	1.0	25824	1000	1000	900	90221	1250
1.0	7.5 x 16.5 (19.5) x 17.5	1.3	25105	1000	1000	800	90222	1000



C (μ F)	DIMENSIONS $w_{max} \times h_{max} \times l_{max}$ (mm)	MASS (g)	CATALOG NUMBER 2222 368 AND PACKAGING						
			LOOSE IN BOX			REEL	LOOSE IN BOX		
			$l_t = 4.0 + 1.0/-0.5$ mm	short leads	long leads	SPQ	$l_t = 4.0 + 1.0/-0.5$ mm	SPQ	
			C-tol = ± 10 %	SPQ	SPQ		C-tol = ± 10 %		
last 5 digits of catalog number	last 5 digits of catalog number								
Pitch = 22.5 ± 0.4 mm; $d_t = 0.80 \pm 0.08$ mm							lock lead		
1.2	6.0 x 18.0 (21.0) x 26.0	2.5	25125	1000	1000	SPQ	90223	1000	
1.5			25155				90224		
1.8	7.0 x 19.0 (22.0) x 26.0	3.2	25185	1000	1000		90225	900	
2.2	7.5 x 19.5 (23.0) x 26.0	3.5	25225	1000	500		90226	750	
2.7	8.5 x 21.5 (24.0) x 26.0	4.1	25275	1000	500		90227	600	
3.3	9.0 x 22.0 (24.5) x 26.0	4.5	25335	1000	500		90228	600	
Pitch = 27.5 ± 0.4 mm; $d_t = 0.80 \pm 0.08$ mm							lock lead		
3.9	9.0 x 22.0 (24.0) x 30.0	4.8	25395	500	500		SPQ	90229	500
4.7	10.0 x 23.0 (25.0) x 30.0	5.5	25475	500	500	90178		400	
5.6	11.0 x 24.0 (26.0) x 30.0	6.2	25565	500	250	90231		350	
6.8	12.0 x 25.0 (27.0) x 30.0	6.8	25685	500	250	90232		350	

$U_{Rdc} = 250$ V; $U_{Rac} = 160$ V

C (μ F)	DIMENSIONS $w_{max} \times h_{max} \times l_{max}$ (mm)	MASS (g)	CATALOG NUMBER 2222 368 AND PACKAGING					
			LOOSE IN BOX			REEL	LOOSE IN BOX	
			$l_t = 4.0 + 1.0/-0.5$ mm	short leads	long leads	SPQ	$l_t = 4.0 + 1.0/-0.5$ mm	SPQ
			C-tol = ± 10 %	SPQ	SPQ		C-tol = ± 10 %	
last 5 digits of catalog number	last 5 digits of catalog number							
Pitch = 10.0 ± 0.4 mm; $d_t = 0.60 \pm 0.06$ mm							lock lead	
0.027	4.2 x 13.0 (15.0) x 12.5	0.4	45273	2000	1000	1500	90233	1250
0.033	4.6 x 13.0 (15.0) x 12.5	0.5	45333	2000	1000	1300	90234	1250
0.039	4.0 x 13.0 (15.0) x 12.5	0.4	45393	2000	1000	1500	90235	1250
0.047	4.5 x 13.5 (15.5) x 12.5	0.5	45473	2000	1000	1500	90176	1250
0.056	4.6 x 13.5 (15.5) x 12.5	0.5	45563	2000	1000	1300	90236	1100
0.068			45683				90237	
0.082	4.4 x 13.4 (16.0) x 12.5	0.5	45823	2000	1000	1200	90238	1000
0.10	4.7 x 13.7 (16.0) x 12.5	0.5	45104	2000	1000	1200	90177	1000
Pitch = 15.0 ± 0.4 mm; $d_t = 0.80 \pm 0.08$ mm							lock lead	
0.12	5.0 x 14.0 (17.0) x 17.5	0.6	45124	2000	1000	1200	90239	1750
0.15			45154				90241	
0.18	5.5 x 14.5 (17.5) x 17.5	0.7	45184	2000	1000	1100	90242	1500
0.22	6.0 x 15.0 (18.0) x 17.5	0.9	45224	2000	1000	1000	90243	1500
0.27	6.0 x 15.5 (18.5) x 17.5	1.0	45274	2000	1000	900	90244	1250
0.33	6.8 x 16.0 (19.0) x 17.5	1.2	45334	1000	1000	800	90245	1250
Pitch = 22.5 ± 0.4 mm; $d_t = 0.80 \pm 0.08$ mm							lock lead	
0.39	5.0 x 17.0 (20.0) x 26.0	1.8	45394	1000	1000	SPQ	90246	1250
0.47	5.5 x 17.5 (20.5) x 26.0	2.2	45474	1000	1000		90247	1250
0.56	6.0 x 18.0 (21.0) x 26.0	2.5	45564	1000	1000		90248	1000
0.68	6.6 x 18.5 (21.5) x 26.0	2.8	45684	1000	1000		90249	1000
0.82	7.2 x 19.0 (22.0) x 26.0	3.2	45824	1000	1000		90251	900
1.0	8.0 x 20.0 (23.0) x 26.0	3.8	45105	1000	500		90252	750



C (μ F)	DIMENSIONS $w_{max} \times h_{max} \times l_{max}$ (mm)	MASS (g)	CATALOG NUMBER 2222 368 AND PACKAGING					
			LOOSE IN BOX			REEL	LOOSE IN BOX	
			$l_t =$ 4.0 + 1.0/- 0.5 mm	short leads	long leads	SPQ	$l_t =$ 4.0 + 1.0/-0.5 mm	SPQ
			C-tol = \pm 10 %	SPQ	SPQ		C-tol = \pm 10 %	
last 5 digits of catalog number	last 5 digits of catalog number							
Pitch = 27.5 \pm 0.4 mm; $d_t = 0.80 \pm 0.08$ mm							lock lead	
1.2	8.0 x 21.0 (23.0) x 30.0	4.1	45125	500	500	SPQ	90253	600
1.5	9.0 x 22.0 (25.0) x 30.0	4.8	45155	500	500		90254	450
1.8	10.0 x 23.0 (26.0) x 30.0	5.5	45185	500	500		90255	400
2.2	11.0 x 24.0 (27.0) x 30.0	6.2	45225	500	250		90256	350

$U_{Rdc} = 400$ V; $U_{Rac} = 220$ V

C (μ F)	DIMENSIONS $w_{max} \times h_{max} \times l_{max}$ (mm)	MASS (g)	CATALOG NUMBER 2222 368 AND PACKAGING					
			LOOSE IN BOX			REEL	LOOSE IN BOX	
			$l_t =$ 4.0 + 1.0/- 0.5 mm	short leads	long leads	SPQ	$l_t =$ 4.0 + 1.0/-0.5 mm	SPQ
			C-tol = \pm 10 %	SPQ	SPQ		C-tol = \pm 10 %	
last 5 digits of catalog number	last 5 digits of catalog number							
Pitch = 10.0 \pm 0.4 mm; $d_t = 0.60 \pm 0.06$ mm							lock lead	
0.0010	4.5 x 13.5 (15.5) x 12.5	0.5	55102	2000	1000	1500	90257	1100
0.0012			55122				90258	
0.0015			55152				90259	
0.0018			55182				90261	
0.0022	4.0 x 13.0 (15.5) x 12.5	0.5	55222	2000	1000	1500	90262	1100
0.0027	4.3 x 13.3 (15.5) x 12.5	0.5	55272	2000	1000	1500	90263	1100
0.0033	4.6 x 13.6 (15.5) x 12.5	0.5	55332	2000	1000	1500	90264	1100
0.0039	4.0 x 13.0 (15.5) x 12.5	0.5	55392	2000	1000	1500	90265	1100
0.0047	4.1 x 13.2 (15.5) x 12.5	0.5	55472	2000	1000	1500	90266	1100
0.0056	4.6 x 13.6 (15.5) x 12.5	0.5	55562	2000	1000	1500	90267	1100
0.0068			55682				90268	
0.0082			55822				90269	
0.010			55103				90271	
0.012	4.0 x 13.0 (15.5) x 12.5	0.5	55123	2000	1000	1500	90272	1100
0.015	4.1 x 13.0 (15.5) x 12.5	0.5	55153	2000	1000	1300	90273	1100
0.018	4.4 x 13.0 (15.5) x 12.5	0.5	55183	2000	1000	1500	90274	1100
0.022	4.2 x 12.9 (15.5) x 12.5	0.5	55223	2000	1000	1500	90175	1100
0.027	4.2 x 13.2 (15.5) x 12.5	0.5	55273	2000	1000	1300	90275	1100
0.033	4.6 x 13.7 (15.5) x 12.5	0.5	55333	2000	1000	1300	90188	1100
Pitch = 15.0 \pm 0.4 mm; $d_t = 0.80 \pm 0.08$ mm							lock lead	
0.039	5.0 x 13.9 (16.5) x 17.5	0.6	55393	2000	1000	1200	90276	2000
0.047	5.4 x 14.5 (17.0) x 17.5	0.7	55473	2000	1000	1200	90277	1750
0.056	5.0 x 13.7 (16.5) x 17.5	0.6	55563	2000	1000	1200	90278	2000
0.068	5.0 x 13.5 (16.5) x 17.5	0.6	55683	2000	1000	1200	90279	2000
0.082	4.8 x 14.0 (16.5) x 17.5	0.6	55823	2000	1000	1100	90281	2000
0.10	5.3 x 14.5 (17.5) x 17.5	0.7	55104	2000	1000	1000	90186	1500
0.12	5.7 x 15.0 (18.0) x 17.5	0.9	55124	1000	1000	900	90282	1500
0.15	6.4 x 15.5 (18.5) x 17.5	1.0	55154	1000	1000	800	90187	1250



C (μ F)	DIMENSIONS $w_{max} \times h_{max} \times l_{max}$ (mm)	MASS (g)	CATALOG NUMBER 2222 368 AND PACKAGING					
			LOOSE IN BOX			REEL	LOOSE IN BOX	
			$l_t =$ 4.0 + 1.0/- 0.5 mm	short leads	long leads	SPQ	$l_t =$ 4.0 + 1.0/-0.5 mm	SPQ
			C-tol = \pm 10 %	SPQ	SPQ		C-tol = \pm 10 %	
last 5 digits of catalog number	last 5 digits of catalog number							
Pitch = 22.5 \pm 0.4 mm; $d_t = 0.80 \pm 0.08$ mm							lock lead	
0.18	5.6 x 17.5 (20.5) x 26.0	2.2	55184	1000	1000		90283	1250
0.22	6.3 x 18.5 (21.5) x 26.0	2.8	55224	1000	1000		90284	1000
0.27	6.0 x 18.0 (21.0) x 26.0	2.5	55274	1000	1000		90285	1000
0.33	6.4 x 18.5 (21.5) x 26.0	2.8	55334	1000	1000		90286	1000
0.39	7.1 x 19.0 (21.5) x 26.0	2.8	55394	1000	1000		90287	900
0.47	8.0 x 20.0 (22.5) x 26.0	3.8	55474	1000	500		90179	750
Pitch = 27.5 \pm 0.4 mm; $d_t = 0.80 \pm 0.08$ mm							lock lead	
0.56	7.5 x 20.5 (22.5) x 30.0	3.8	55564	500	500		90288	600
0.68	8.5 x 21.5 (23.5) x 30.0	4.5	55684	500	500		90289	500
0.82	9.5 x 22.5 (24.5) x 30.0	5.2	55824	500	500		90291	450
1.0	10.5 x 23.5 (26.5) x 30.0	5.8	55105	500	250		90292	350

$U_{Rdc} = 630$ V; $U_{Rac} = 250$ V

C (μ F)	DIMENSIONS $w_{max} \times h_{max} \times l_{max}$ (mm)	MASS (g)	CATALOG NUMBER 2222 368 AND PACKAGING					
			LOOSE IN BOX			REEL	LOOSE IN BOX	
			$l_t =$ 4.0 + 1.0/- 0.5 mm	short leads	long leads	SPQ	$l_t =$ 4.0 + 1.0/-0.5 mm	SPQ
			C-tol = \pm 10 %	SPQ	SPQ		C-tol = \pm 10 %	
last 5 digits of catalog number	last 5 digits of catalog number							
Pitch = 10.0 \pm 0.4 mm; $d_t = 0.60 \pm 0.06$ mm							lock lead	
0.010	4.3 x 13.1 (15.5) x 12.5	0.5	65103	2000	1000	1300	90293	1100
0.012	4.6 x 13.4 (16.0) x 12.5	0.5	65123	2000	1000	1200	90294	1000
0.015	4.9 x 13.9 (16.5) x 12.5	0.6	65153	2000	1000	1100	90295	1500
0.018	5.3 x 14.3 (17.0) x 12.5	0.6	65183	2000	1000	1000	90296	1250
0.022	5.9 x 14.9 (17.5) x 12.5	0.8	65223	2000	1000	900	90297	1250
Pitch = 15.0 \pm 0.4 mm; $d_t = 0.80 \pm 0.08$ mm							lock lead	
0.027	5.5 x 14.5 (17.5) x 17.5	0.7	65273	2000	1000	1100	90298	1500
0.033	6.0 x 15.0 (18.0) x 17.5	0.9	65333	2000	1000	1000	90299	1500
0.039	6.3 x 15.5 (18.5) x 17.5	1.0	65393	2000	1000	900	90301	1250
0.047	7.0 x 16.0 (19.0) x 17.5	1.2	65473	2000	1000	800	90302	1250
0.056	7.5 x 16.5 (19.5) x 17.5	1.3	65563	1000	1000	800	90303	1000
0.068	8.0 x 17.0 (20.0) x 17.5	1.4	65683	1000	1000	750	90304	1000
Pitch = 22.5 \pm 0.4 mm; $d_t = 0.80 \pm 0.08$ mm							lock lead	
0.082	6.1 x 18.0 (21.0) x 26.0	2.5	65823	1000	1000		90305	1000
0.10	7.0 x 19.0 (22.0) x 26.0	3.2	65104	1000	1000		90306	900
0.12	7.2 x 19.5 (22.5) x 26.0	3.5	65124	1000	1000		90307	750
0.15	8.0 x 21.0 (23.0) x 26.0	3.8	65154	1000	500		90308	750
0.18	9.0 x 22.0 (24.0) x 26.0	4.5	65184	1000	500		90309	600
0.22	10.0 x 23.0 (25.0) x 26.0	5.2	65224	1000	500		90311	550



C (μ F)	DIMENSIONS $w_{max} \times h_{max} \times l_{max}$ (mm)	MASS (g)	CATALOG NUMBER 2222 368 AND PACKAGING					
			LOOSE IN BOX			REEL	LOOSE IN BOX	
			$l_t =$ 4.0 + 1.0/- 0.5 mm	short leads	long leads	SPQ	$l_t =$ 4.0 + 1.0/-0.5 mm	SPQ
			C-tol = \pm 10 %	SPQ	SPQ		C-tol = \pm 10 %	
last 5 digits of catalog number			lock lead			last 5 digits of catalog number		
Pitch = 27.5 \pm 0.4 mm; $d_t = 0.80 \pm 0.08$ mm								
0.27	10.0 x 23.0 (25.0) x 30.0	5.5	65274	500	500	90312	400	
0.33	11.5 x 24.5 (26.5) x 30.0	6.5	65334	500	250	90313	350	
0.39	12.5 x 25.5 (28.5) x 30.0	7.1	65394	500	250	90314	300	
0.47	14.0 x 27.0 (30.0) x 30.0	8.2	65474	250	250	90315	250	

CAPACITANCE

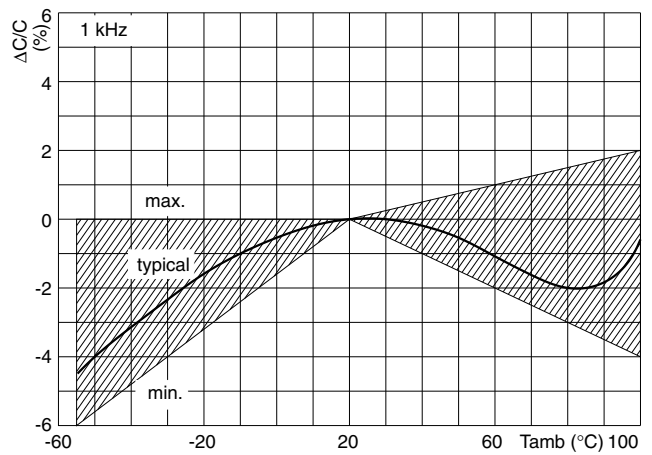
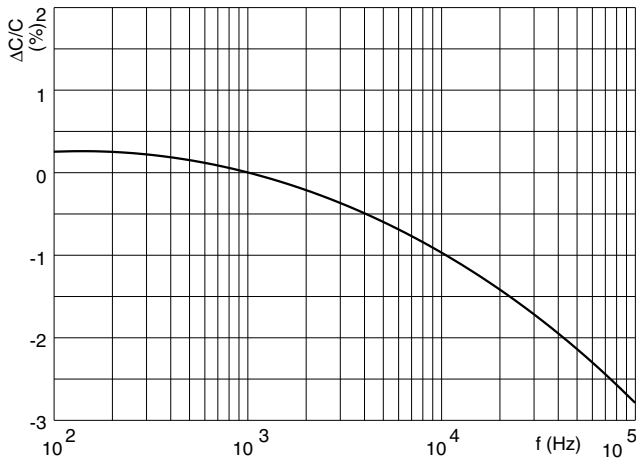

IMPEDANCE

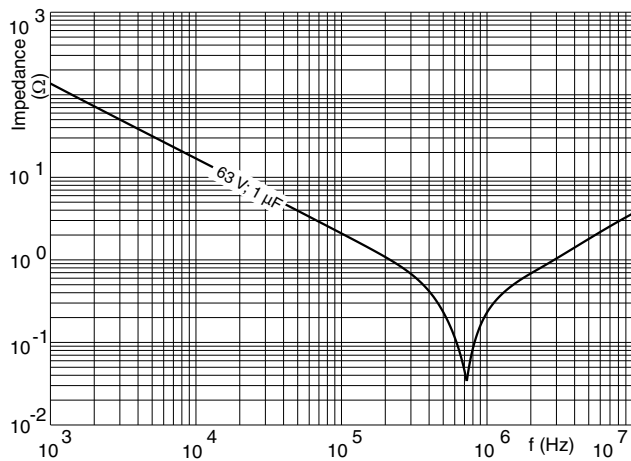



MAXIMUM RMS VOLTAGE (SINEWAVE) AS A FUNCTION OF FREQUENCY

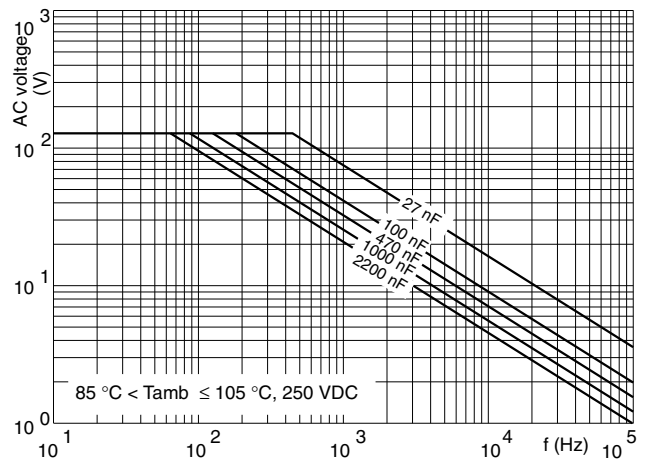
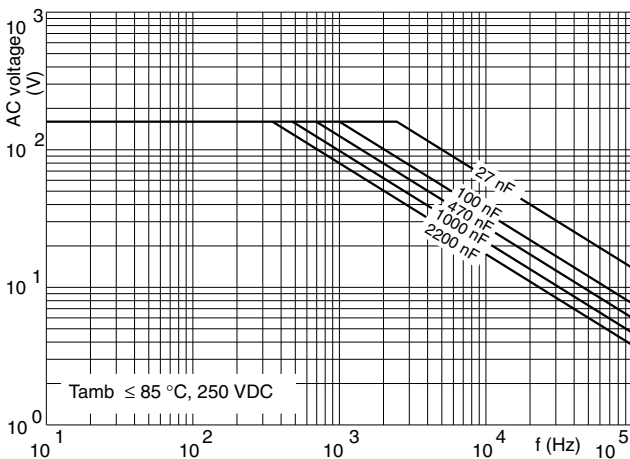
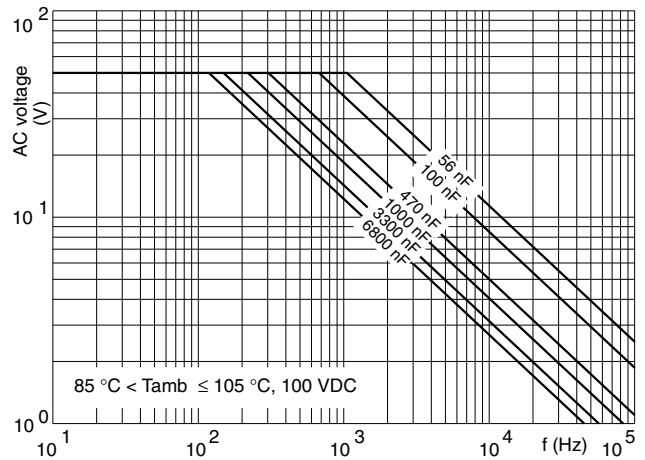
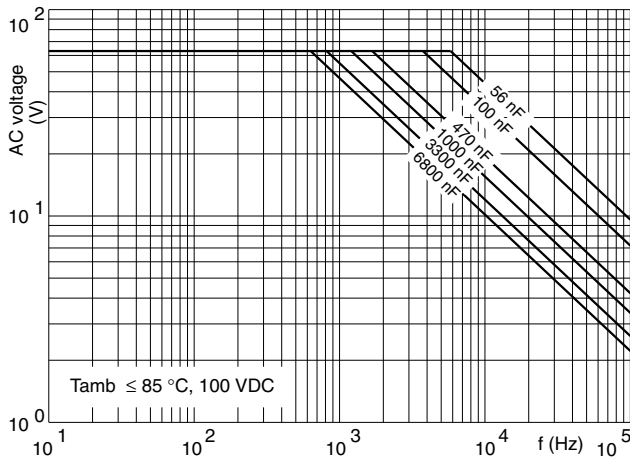
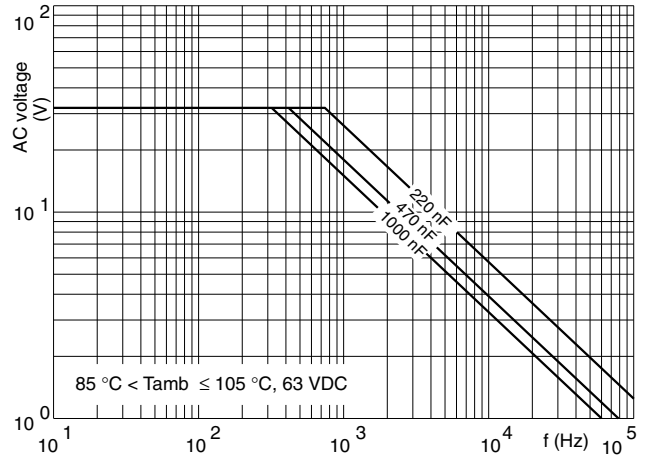
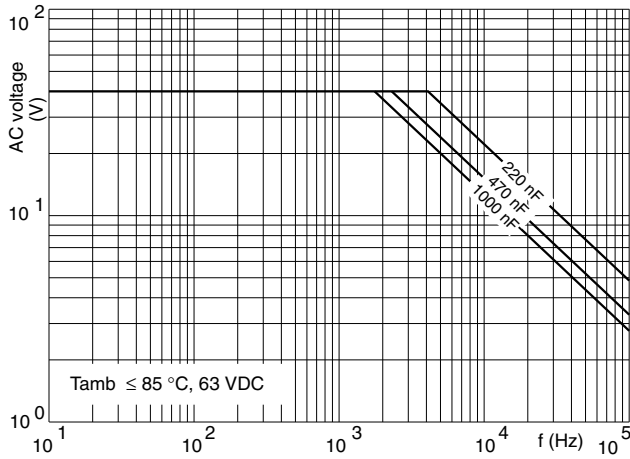

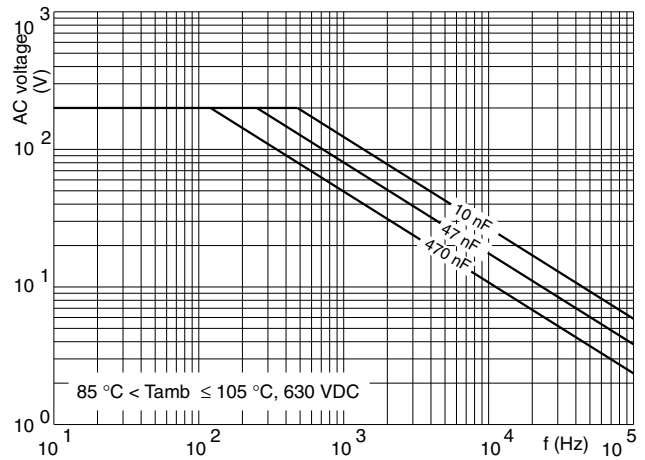
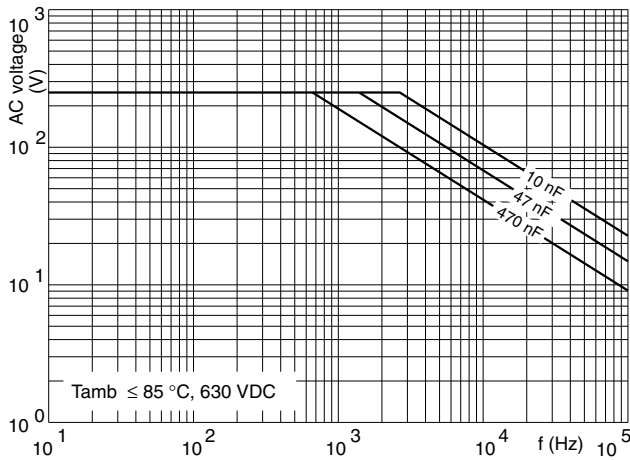
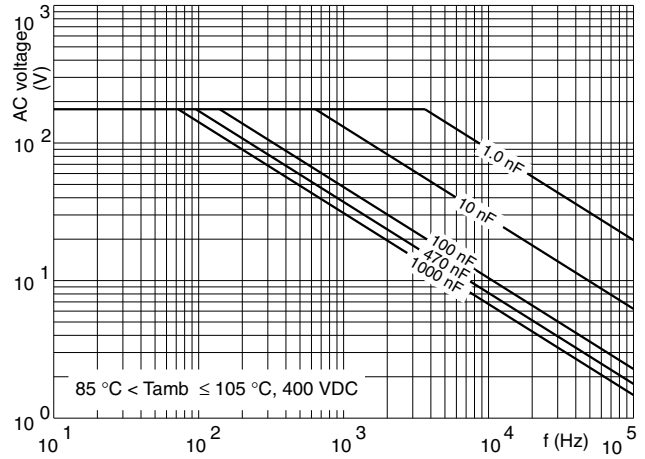
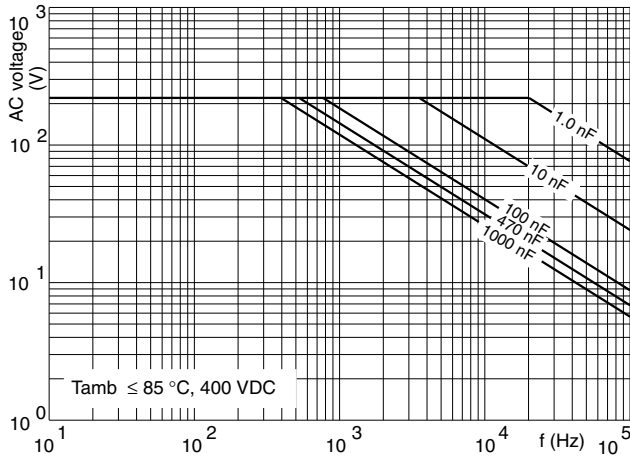

APPLICATION NOTE AND LIMITING CONDITIONS

These capacitors are not suitable for mains applications as across-the-line capacitors without additional protection, as described hereunder. These mains applications are strictly regulated in safety standards and therefore electromagnetic interference suppression capacitors conforming the standards must be used.

For capacitors connected in parallel, normally the proof voltage and possibly the rated voltage must be reduced. For information depending of the capacitance value and the number of parallel connections contact dc-film@vishay.com.

To select the capacitor for a certain application, the following conditions must be checked:

1. The peak voltage (U_P) shall not be greater than the rated DC voltage (U_{RDC})
2. The peak-to-peak voltage (U_{P-P}) shall not be greater than $2\sqrt{2} \times U_{RAC}$ to avoid the ionization inception level
3. The voltage peak slope (dU/dt) shall not exceed the rated voltage pulse slope in an RC-circuit at rated voltage and without ringing. If the pulse voltage is lower than the rated DC voltage, the rated voltage pulse slope may be multiplied by U_{RDC} and divided by the applied voltage.

For all other pulses following equation must be fulfilled:

$$2 \times \int_0^T \left(\frac{dU}{dt} \right)^2 \times dt < U_{RDC} \times \left(\frac{dU}{dt} \right)_{\text{rated}}$$

T is the pulse duration.

The rated voltage pulse slope is valid for ambient temperatures up to 85 °C. For higher temperatures a derating factor of 3 % per K shall be applied.

4. The maximum component surface temperature rise must be lower than the limits (see figure “Max. allowed component temperature rise”).
5. Since in circuits used at voltages over 280 V peak-to-peak the risk for an intrinsically active flammability after a capacitor breakdown (short circuit) increases, it is recommended that the power to the component is limited to 100 times the values mentioned in the table “Heat Conductivity”.
6. When using these capacitors as across-the-line capacitor in the input filter for mains applications the applicant must guarantee that the following conditions are fulfilled in any case (spikes and surge voltages from the mains included).
7. For continuous use as series connection with an impedance to the mains, please refer to application note www.vishay.com/doc?28153

Voltage Conditions for 6 Above

ALLOWED VOLTAGES	$T_{\text{amb}} \leq 85 \text{ °C}$	$85 \text{ °C} < T_{\text{amb}} \leq 105 \text{ °C}$
Maximum continuous RMS voltage	U_{RAC}	$0.8 \times U_{RAC}$
Maximum temperature RMS-overvoltage (< 24 h)	$1.25 \times U_{RAC}$	U_{RAC}
Maximum peak voltage (V_{O-P}) (< 2 s)	$1.6 \times U_{RDC}$	$1.3 \times U_{RDC}$

Example

C = 3300 nF - 100 V used for the voltage signal shown in next figure.

$U_{P-P} = 80 \text{ V}$; $U_P = 70 \text{ V}$; $T_1 = 0.5 \text{ ms}$; $T_2 = 1 \text{ ms}$

The ambient temperature is 35 °C

Checking conditions:

1. The peak voltage $U_P = 70 \text{ V}$ is lower than $100 V_{DC}$
2. The peak-to-peak voltage 80 V is lower than $2\sqrt{2} \times 63 V_{AC} = 178 U_{P-P}$
3. The voltage pulse slope (dU/dt) = $80 \text{ V}/500 \mu\text{s} = 0.16 \text{ V}/\mu\text{s}$
This is lower than $8 \text{ V}/\mu\text{s}$ (see “Specific Reference Data” for each version)
4. The dissipated power is 60 mW as calculated with fourier terms
The temperature rise for $W_{\text{max.}} = 8.5 \text{ mm}$ and pitch = 22.5 mm will be $60 \text{ mW}/18 \text{ mW}/\text{°C} = 3.3 \text{ °C}$
This is lower than 15 °C temperature rise at 35 °C, according figure “Maximum allowed component temperature rise”
5. Not applicable
6. Not applicable
7. Not applicable

Voltage Signal

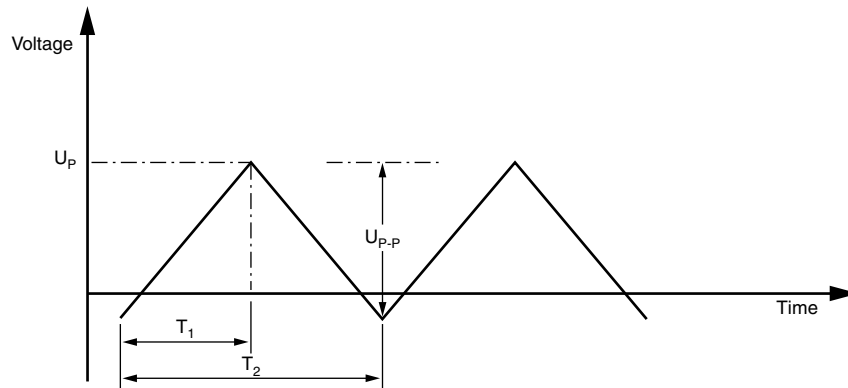



Disclaimer

ALL PRODUCT, PRODUCT SPECIFICATIONS AND DATA ARE SUBJECT TO CHANGE WITHOUT NOTICE TO IMPROVE RELIABILITY, FUNCTION OR DESIGN OR OTHERWISE.

Vishay Intertechnology, Inc., its affiliates, agents, and employees, and all persons acting on its or their behalf (collectively, "Vishay"), disclaim any and all liability for any errors, inaccuracies or incompleteness contained in any datasheet or in any other disclosure relating to any product.

Vishay makes no warranty, representation or guarantee regarding the suitability of the products for any particular purpose or the continuing production of any product. To the maximum extent permitted by applicable law, Vishay disclaims (i) any and all liability arising out of the application or use of any product, (ii) any and all liability, including without limitation special, consequential or incidental damages, and (iii) any and all implied warranties, including warranties of fitness for particular purpose, non-infringement and merchantability.

Statements regarding the suitability of products for certain types of applications are based on Vishay's knowledge of typical requirements that are often placed on Vishay products in generic applications. Such statements are not binding statements about the suitability of products for a particular application. It is the customer's responsibility to validate that a particular product with the properties described in the product specification is suitable for use in a particular application. Parameters provided in datasheets and / or specifications may vary in different applications and performance may vary over time. All operating parameters, including typical parameters, must be validated for each customer application by the customer's technical experts. Product specifications do not expand or otherwise modify Vishay's terms and conditions of purchase, including but not limited to the warranty expressed therein.

Hyperlinks included in this datasheet may direct users to third-party websites. These links are provided as a convenience and for informational purposes only. Inclusion of these hyperlinks does not constitute an endorsement or an approval by Vishay of any of the products, services or opinions of the corporation, organization or individual associated with the third-party website. Vishay disclaims any and all liability and bears no responsibility for the accuracy, legality or content of the third-party website or for that of subsequent links.

Vishay products are not designed for use in life-saving or life-sustaining applications or any application in which the failure of the Vishay product could result in personal injury or death unless specifically qualified in writing by Vishay. Customers using or selling Vishay products not expressly indicated for use in such applications do so at their own risk. Please contact authorized Vishay personnel to obtain written terms and conditions regarding products designed for such applications.

No license, express or implied, by estoppel or otherwise, to any intellectual property rights is granted by this document or by any conduct of Vishay. Product names and markings noted herein may be trademarks of their respective owners.