



# SGM4995

## 1.3W Mono Fully Differential Audio Power Amplifier

---

### GENERAL DESCRIPTION

The SGM4995 is a fully differential audio power amplifier which operates from 2.5V to 5.5V power supply. It can deliver 1.3W into a 8Ω load from 5V supply at THD+N = 1%. It is designed for portable applications.

The SGM4895 has pop/click suppression circuitry, low power consumption shutdown mode and thermal shutdown protection.

Bootstrap capacitors or output coupling capacitors are not needed.

The SGM4995 is available in a Green TDFN-2×2-8L package. It operates over an ambient temperature range of -40°C to +85°C.

### FEATURES

- **Supply Voltage Range: 2.5V to 5.5V**
- **1.3W into 8Ω Load from 5V Supply at THD+N = 1% (TYP)**
- **High PSRR**
- **Low Shutdown Current**
- **Pop/Click Suppression Circuitry**
- **Support Single-Ended or Differential Input**
- **Thermal Overload Protection Circuitry**
- **External Gain Configuration Capability**
- **-40°C to +85°C Operating Temperature Range**
- **Available in a Green TDFN-2×2-8L Package**

### APPLICATIONS

PDA's  
GPS  
Mobile Phones  
Wireless Handsets  
Handheld Computers  
Portable Systems

**PACKAGE/ORDERING INFORMATION**

| MODEL   | PACKAGE DESCRIPTION | SPECIFIED TEMPERATURE RANGE | ORDERING NUMBER | PACKAGE MARKING | PACKING OPTION      |
|---------|---------------------|-----------------------------|-----------------|-----------------|---------------------|
| SGM4995 | TDFN-2x2-8L         | -40°C to +85°C              | SGM4995YDE8G/TR | 4995<br>XXXX    | Tape and Reel, 3000 |

**MARKING INFORMATION**

NOTE: XXXXX = Date Code and Vendor Code.

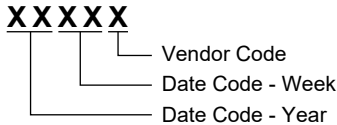

Green (RoHS & HSF): SG Micro Corp defines "Green" to mean Pb-Free (RoHS compatible) and free of halogen substances. If you have additional comments or questions, please contact your SGMICRO representative directly.

**ABSOLUTE MAXIMUM RATINGS**

- Supply Voltage.....6V
- Input Voltage Range.....-0.3V to (V<sub>CC</sub>) + 0.3V
- Typical Thermal Resistance
- TDFN-3x3-8L,  $\theta_{JA}$ .....72°C/W
- Junction Temperature.....+150°C
- Storage Temperature Range.....-65°C to +150°C
- Lead Temperature (Soldering, 10s).....+260°C
- ESD Susceptibility
- HBM.....2000V
- MM.....400V

**RECOMMENDED OPERATING CONDITIONS**

- Supply Voltage Range.....2.5V to 5.5V
- Operating Temperature Range.....-40°C to +85°C

**OVERSTRESS CAUTION**

Stresses beyond those listed in Absolute Maximum Ratings may cause permanent damage to the device. Exposure to absolute maximum rating conditions for extended periods may affect reliability. Functional operation of the device at any conditions beyond those indicated in the Recommended Operating Conditions section is not implied.

**ESD SENSITIVITY CAUTION**

This integrated circuit can be damaged if ESD protections are not considered carefully. SGMICRO recommends that all integrated circuits be handled with appropriate precautions. Failure to observe proper handling and installation procedures can cause damage. ESD damage can range from subtle performance degradation to complete device failure. Precision integrated circuits may be more susceptible to damage because even small parametric changes could cause the device not to meet the published specifications.

**PIN CONFIGURATION**

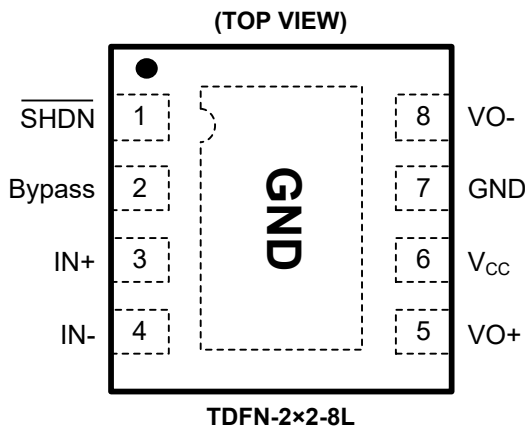

**DISCLAIMER**

SG Micro Corp reserves the right to make any change in circuit design, or specifications without prior notice.

## ELECTRICAL CHARACTERISTICS

(The following AC specifications apply for 8Ω load,  $A_V = 1V/V$ ,  $T_A = +25^\circ\text{C}$ , unless otherwise specified.)

| PARAMETER                                      | SYMBOL     | CONDITIONS   | MIN                                   | TYP   | MAX  | UNITS         |    |
|--|------------|--|---------------------------------------|-------|------|---------------|----|
| Supply Voltage                                 | $V_{CC}$   |  | 2.5                                   |       | 5.5  | V             |    |
| Shutdown Current                               | $I_{SD}$   | $V_{IN} = 0V, V_{SHDN} = GND$                                  |                                       | 0.02  | 2    | $\mu\text{A}$ |    |
| Output Offset Voltage                          | $V_{OS}$   | $V_{IN} = 0V, V_{SHDN} = V_{CC} = 5.0V$                        | -10                                   | 2.5   | 10   | mV            |    |
|  |            | $V_{IN} = 0V, V_{SHDN} = V_{CC} = 3.3V$                        | -10                                   | 2.0   | 10   |               |    |
|  |            | $V_{IN} = 0V, V_{SHDN} = V_{CC} = 2.6V$                        |                                       | 2.0   |      |               |    |
| Quiescent Power Supply Current                 | $I_Q$      | $V_{IN} = 0V, I_O = 0A, V_{SHDN} = V_{CC}$                     | $V_{CC} = 5.0V, \text{No Load}$       |       | 4.72 | 8             | mA |
|  |            |  | $V_{CC} = 5.0V, 8\Omega \text{ Load}$ |       | 4.75 | 8.2           |    |
|  |            |  | $V_{CC} = 3.3V, \text{No Load}$       |       | 3.70 | 6             |    |
|  |            |  | $V_{CC} = 3.3V, 8\Omega \text{ Load}$ |       | 3.72 |               |    |
|  |            |  | $V_{CC} = 2.6V, \text{No Load}$       |       | 2.90 |               |    |
|  |            |  | $V_{CC} = 2.6V, 8\Omega \text{ Load}$ |       | 3.00 |               |    |
| Shutdown Voltage Input High                    | $V_{SDIH}$ |  | 1.2                                   |       |      | V             |    |
| Shutdown Voltage Input Low                     | $V_{SDIL}$ |  |                                       |       | 0.4  | V             |    |
| Output Power (8Ω)                              | $P_O$      | $f = 1\text{kHz}, \text{THD+N} = 1\%$                          | $V_{CC} = 5.0V$                       |       | 1.30 |               | W  |
|  |            |  | $V_{CC} = 3.6V$                       |       | 0.65 |               |    |
|  |            |  | $V_{CC} = 3.0V$                       |       | 0.47 |               |    |
|  |            |  | $V_{CC} = 2.6V$                       |       | 0.34 |               |    |
|  |            | $f = 1\text{kHz}, \text{THD+N} = 10\%$                         | $V_{CC} = 5.0V$                       |       | 1.60 |               |    |
|  |            |  | $V_{CC} = 3.6V$                       |       | 0.84 |               |    |
|  |            |  | $V_{CC} = 3.0V$                       |       | 0.58 |               |    |
|  |            |  | $V_{CC} = 2.6V$                       |       | 0.42 |               |    |
| Total Harmonic Distortion + Noise              | THD+N      | $P_O = 0.6W_{rms}, f = 1\text{kHz}, V_{CC} = 5.0V$             |                                       | 0.042 |      | %             |    |
| Power Supply Rejection Ratio <sup>(1)(2)</sup> | PSRR       | $f = 217\text{Hz}$   | $V_{CC} = 5.0V$                       |       | -62  |               | dB |
|  |            |  | $V_{CC} = 3.6V$                       |       | -60  |               |    |
|  |            |  | $V_{CC} = 3.0V$                       |       | -58  |               |    |
|  |            |  | $V_{CC} = 2.6V$                       |       | -57  |               |    |
|  |            | $f = 1\text{kHz}$  | $V_{CC} = 5.0V$                       |       | -73  |               |    |
|  |            |  | $V_{CC} = 3.6V$                       |       | -71  |               |    |
|  |            |  | $V_{CC} = 3.0V$                       |       | -70  |               |    |
|  |            |  | $V_{CC} = 2.6V$                       |       | -63  |               |    |
| Common Mode Rejection Ratio <sup>(2)</sup>     | CMRR       | $f = 217\text{Hz}, V_{CM} = 200\text{mV}_{P-P}, V_{CC} = 5.0V$ |                                       | -74   |      | dB            |    |
| Wake-Up Time                                   | $T_{WU}$   | $C_B = 1\mu\text{F}$   | $V_{CC} = 5.0V$                       |       | 50   | ms            |    |
|  |            |  | $V_{CC} = 3.6V$                       |       | 42   |               |    |
|  |            |  | $V_{CC} = 3.0V$                       |       | 37   |               |    |
|  |            |  | $V_{CC} = 2.6V$                       |       | 32   |               |    |

## NOTES:

- 10Ω terminated input.
- PSRR and CMRR are affected by the matching between gain-setting resistor ratios.

TYPICAL PERFORMANCE CHARACTERISTICS

At  $T_A = +25^\circ\text{C}$ ,  $A_V = 1$ ,  $f = 1\text{kHz}$ ,  $C_B = 1\mu\text{F}$ , unless otherwise noted.

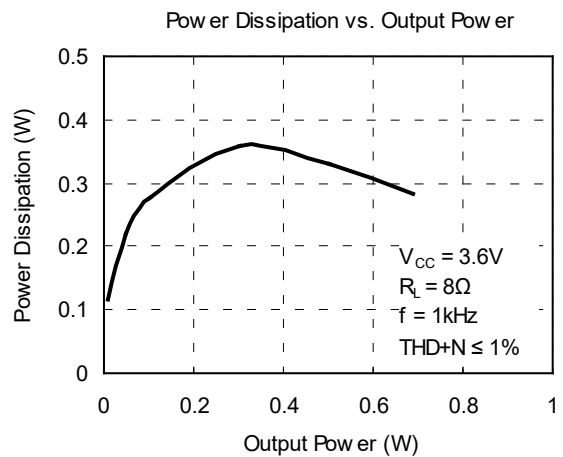
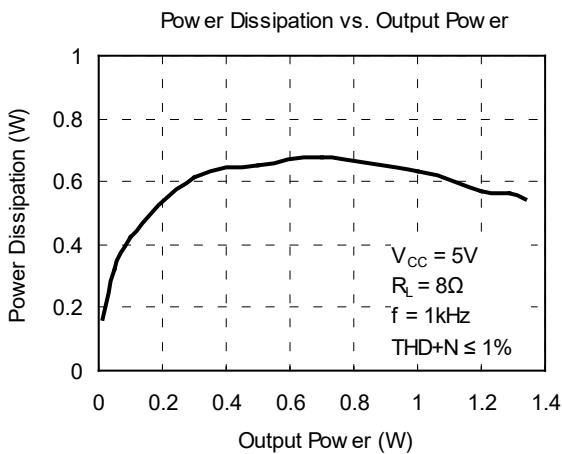
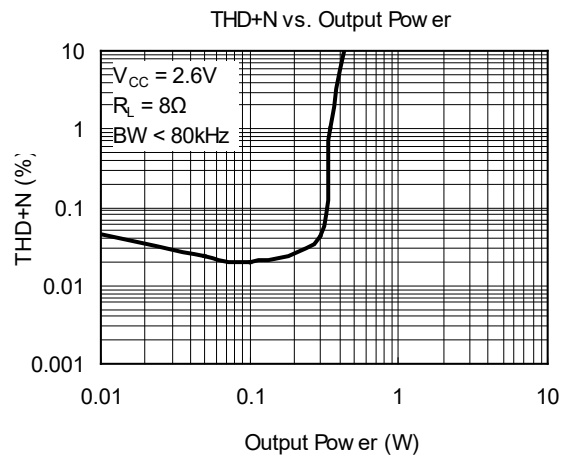
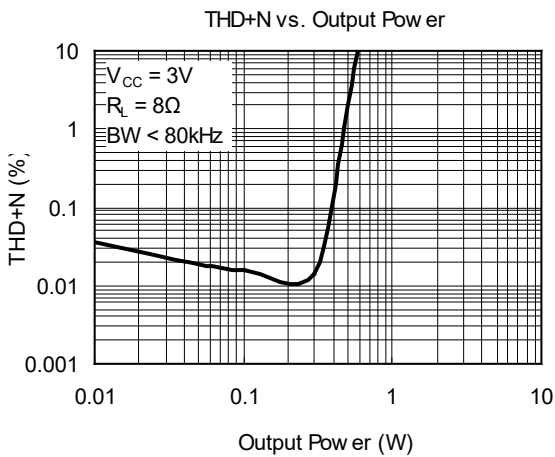
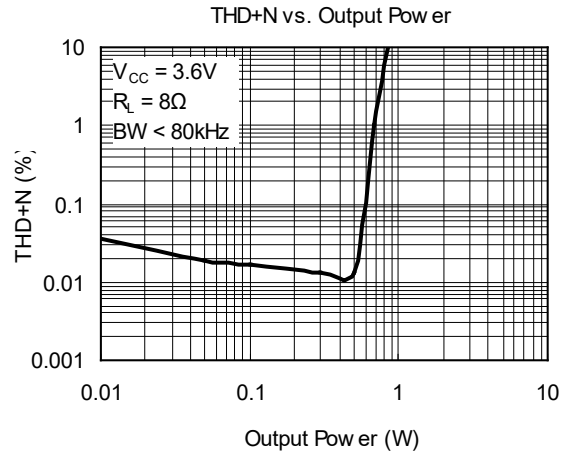
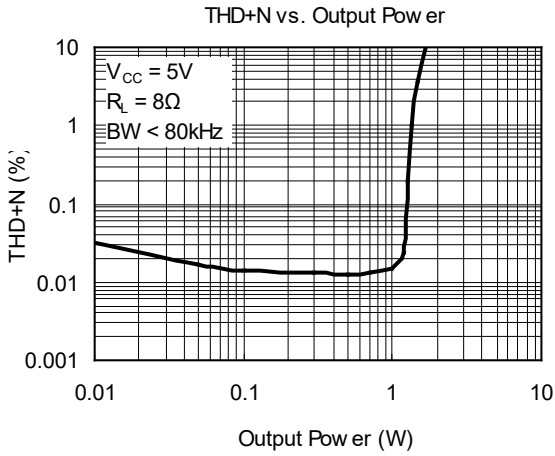

TYPICAL PERFORMANCE CHARACTERISTICS (continued)

At  $T_A = +25^\circ\text{C}$ ,  $A_V = 1$ ,  $f = 1\text{kHz}$ ,  $C_B = 1\mu\text{F}$ , unless otherwise noted.

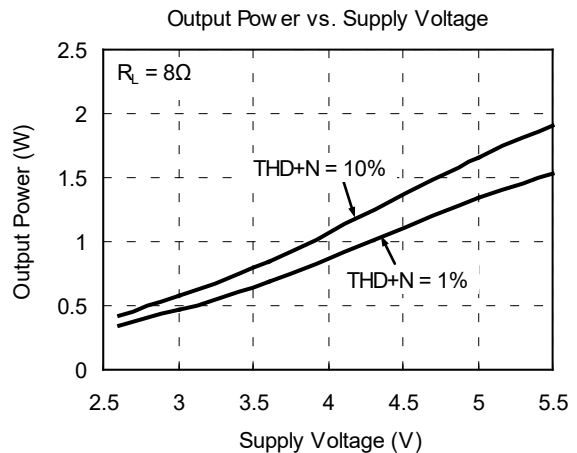
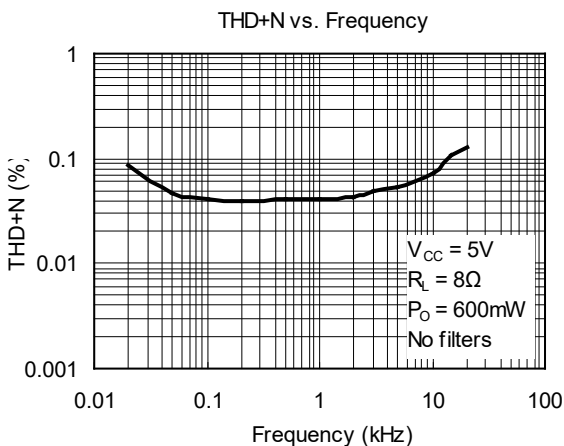
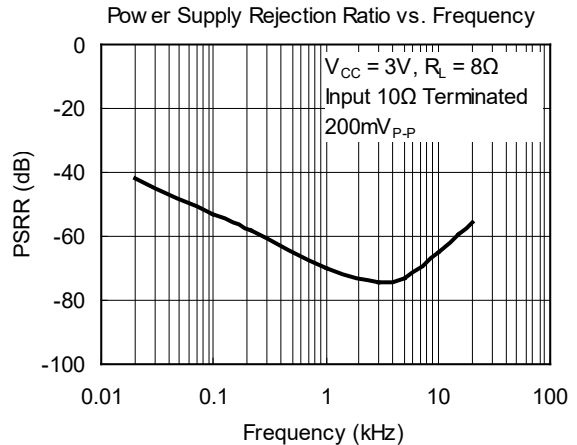
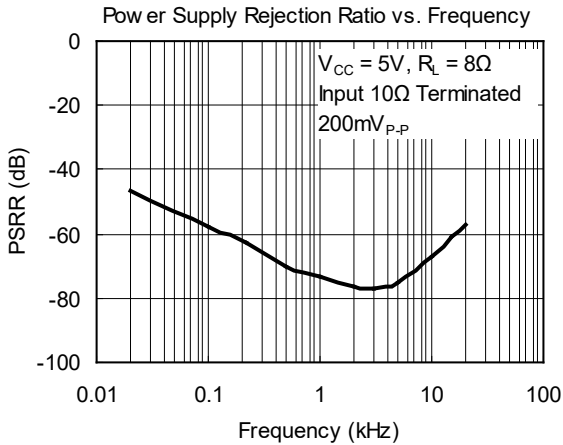
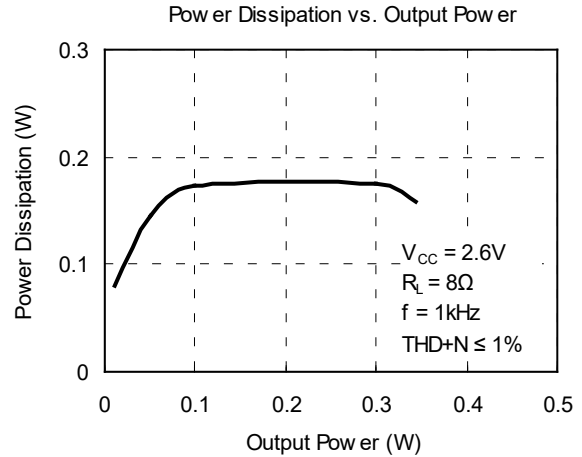
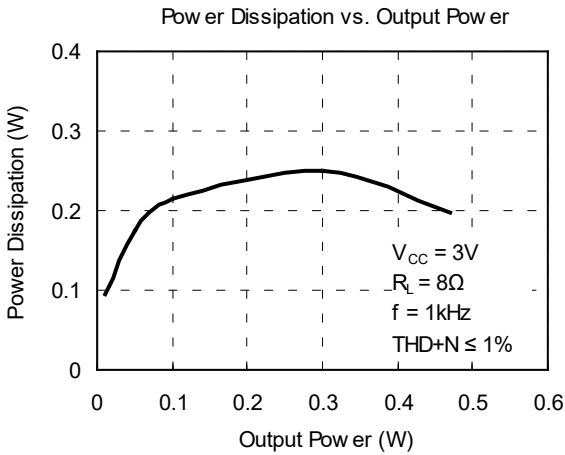

**TYPICAL PERFORMANCE CHARACTERISTICS (continued)**

At  $T_A = +25^\circ\text{C}$ ,  $A_V = 1$ ,  $f = 1\text{kHz}$ ,  $C_B = 1\mu\text{F}$ , unless otherwise noted.

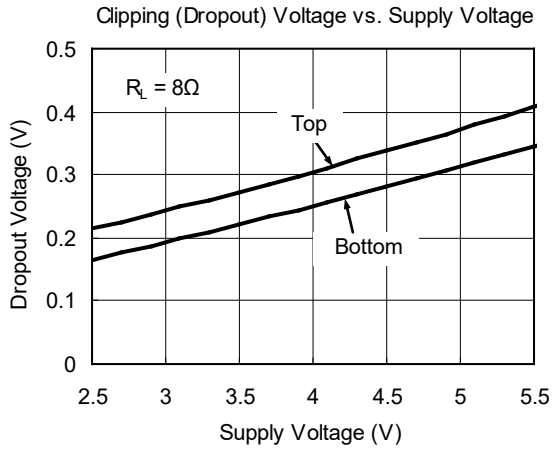

PACKAGE OUTLINE DIMENSIONS

TDFN-2x2-8L

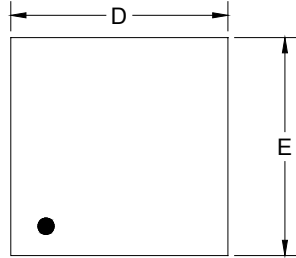

TOP VIEW

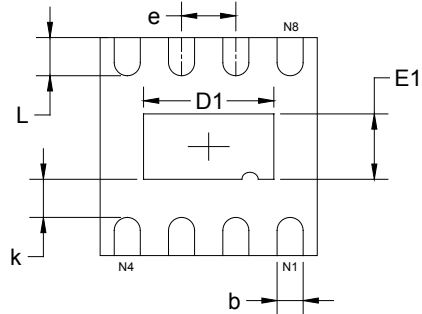

BOTTOM VIEW

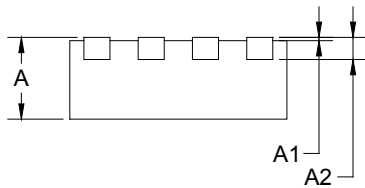

SIDE VIEW

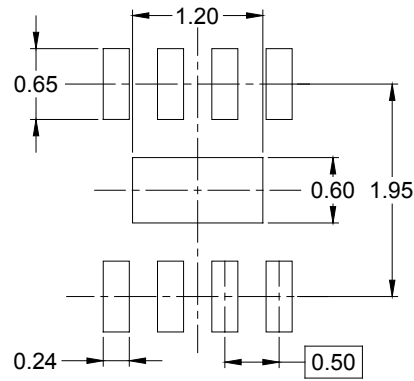

RECOMMENDED LAND PATTERN (Unit: mm)

| Symbol | Dimensions<br>In Millimeters |       | Dimensions<br>In Inches |       |
|--------|------------------------------|-------|-------------------------|-------|
|        | MIN                          | MAX   | MIN                     | MAX   |
| A      | 0.700                        | 0.800 | 0.028                   | 0.031 |
| A1     | 0.000                        | 0.050 | 0.000                   | 0.002 |
| A2     | 0.203 REF                    |       | 0.008 REF               |       |
| D      | 1.900                        | 2.100 | 0.075                   | 0.083 |
| D1     | 1.100                        | 1.300 | 0.043                   | 0.051 |
| E      | 1.900                        | 2.100 | 0.075                   | 0.083 |
| E1     | 0.500                        | 0.700 | 0.020                   | 0.028 |
| k      | 0.200 MIN                    |       | 0.008 MIN               |       |
| b      | 0.180                        | 0.300 | 0.007                   | 0.012 |
| e      | 0.500 TYP                    |       | 0.020 TYP               |       |
| L      | 0.250                        | 0.450 | 0.010                   | 0.018 |

# PACKAGE INFORMATION

## TAPE AND REEL INFORMATION

### REEL DIMENSIONS



### TAPE DIMENSIONS



NOTE: The picture is only for reference. Please make the object as the standard.

### KEY PARAMETER LIST OF TAPE AND REEL

| Package Type | Reel Diameter | Reel Width W1 (mm) | A0 (mm) | B0 (mm) | K0 (mm) | P0 (mm) | P1 (mm) | P2 (mm) | W (mm) | Pin1 Quadrant |
|--------------|---------------|--------------------|---------|---------|---------|---------|---------|---------|--------|---------------|
| TDFN-2×2-8L  | 7"            | 9.5                | 2.30    | 2.30    | 1.10    | 4.0     | 4.0     | 2.0     | 8.0    | Q1            |

000001



# PACKAGE INFORMATION

## CARTON BOX DIMENSIONS



NOTE: The picture is only for reference. Please make the object as the standard.

## KEY PARAMETER LIST OF CARTON BOX

| Reel Type   | Length (mm) | Width (mm) | Height (mm) | Pizza/Carton |
|-------------|-------------|------------|-------------|--------------|
| 7" (Option) | 368         | 227        | 224         | 8            |
| 7"          | 442         | 410        | 224         | 18           |

DD0002