

Time-of-Flight ranging sensor

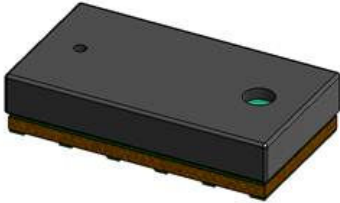

Product status link

[VL53L0X](#)

Features

Fully integrated miniature module

- 940 nm laser VCSEL (vertical-cavity surface-emitting laser)
- VCSEL driver
- Ranging sensor with advanced embedded microcontroller
- 4.4 x 2.4 x 1.0 mm

Fast, accurate distance ranging

- Measures absolute range up to 2 m
- The reported range is independent of the target reflectance
- Advanced embedded optical crosstalk compensation to simplify cover glass selection

Eye safety

- Class 1 laser device compliant with latest standard IEC 60825-1:2014 - 3rd edition

Easy integration

- Single reflowable component
- No additional optics
- Single power supply
- I²C interface for device control and data transfer
- Xshutdown (reset) and interrupt GPIO
- Programmable I²C address

Application

- Access control (system activation and presence detection)
- Robotics (collision avoidance, wall tracking, and cliff detection)
- Home appliance and home automation
- Inventory management and liquid level monitoring

Description

The VL53L0X is a Time-of-Flight (ToF) laser-ranging module housed in the smallest package on the market today, providing accurate distance measurement whatever the target reflectance, unlike conventional technologies. It can measure absolute distances up to 2 m, setting a new benchmark in ranging performance levels, opening the door to various new applications.

The VL53L0X integrates a leading-edge SPAD array (single photon avalanche diodes) and embeds ST's second generation FlightSense patented technology.

The VL53L0X's 940 nm VCSEL emitter (vertical cavity surface-emitting laser), is totally invisible to the human eye, coupled with internal physical infrared filters, it enables longer ranging distances, higher immunity to ambient light, and better robustness to cover glass optical crosstalk.

1 Acronyms and abbreviations

Table 1. Acronyms and abbreviations

Acronym/abbreviation	Definition
API	application programming interface
cal	calibration
ESD	electrostatic discharge
FoV	field of view
FW BOOT	firmware boot
HW STANDBY	hardware standby
I ² C	inter-integrated circuit (serial bus)
MSB	most significant bit
NVM	non-volatile memory
PCB	printed circuit board
PVT	power, voltage, and temperature
RIT	return ignore threshold
SCL	serial clock line
SDA	serial data line
SW STANDBY	software standby
SPAD	single photon avalanche diode
ToF	Time-of-Flight
VCSEL	vertical-cavity surface-emitting laser
VHV	very high voltage

2 Overview

2.1 Technical specification

Table 2. Technical specification

Feature	Detail
Package	Optical LGA12
Size	4.4 x 2.4 x 1 mm
Operating voltage	2.6 to 3.5 V
Operating temperature	-20 to 70°C
Infrared emitter	940 nm
I ² C	Up to 400 kHz (fast mode) serial bus Address: 0x52

2.2 System block diagram

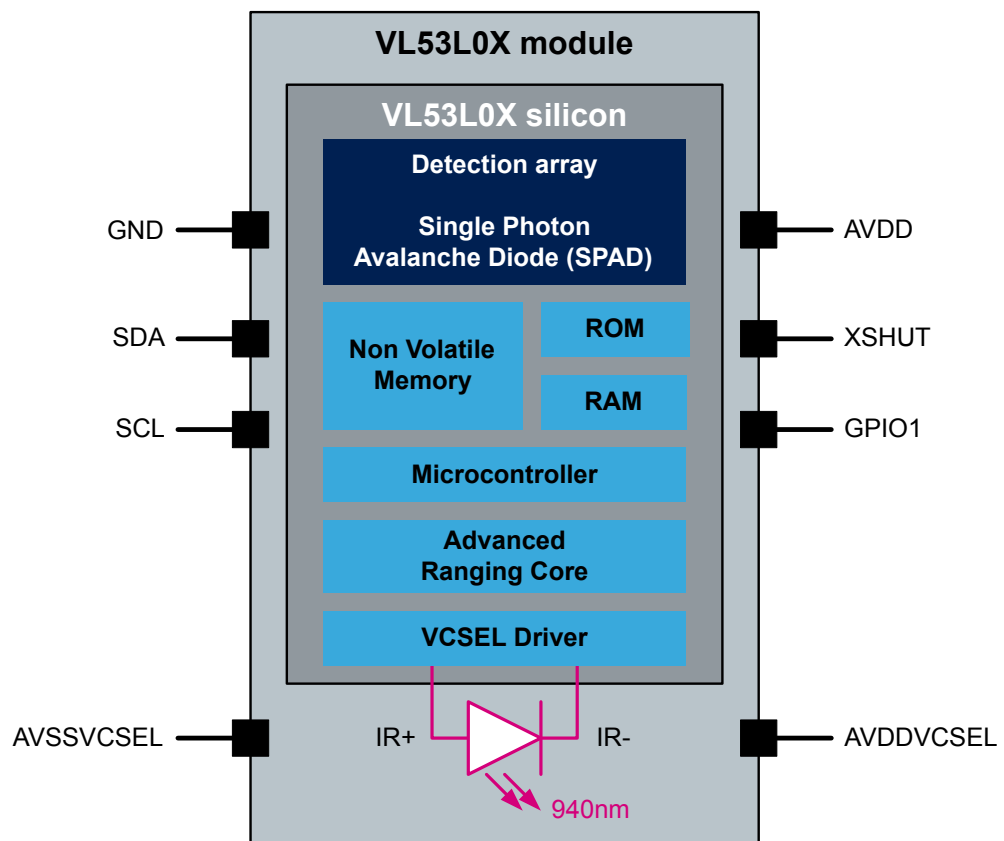
Figure 1. VL53L0X block diagram

2.3 Device pinout

The following figure shows the pinout of the VL53L0X (see also [Section 7: Outline drawings](#)).

Figure 2. VL53L0X pinout (bottom view)

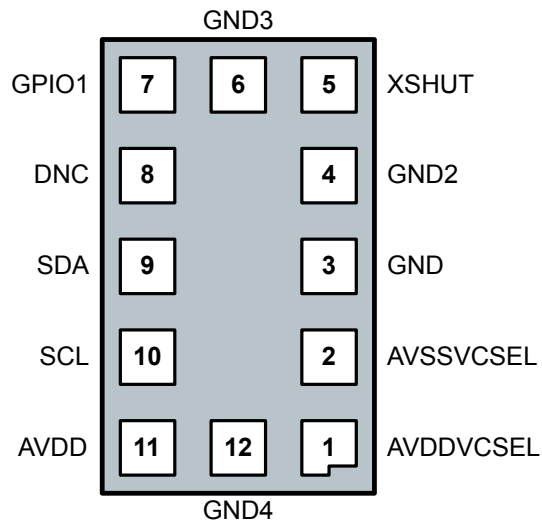

Table 3. VL53L0X pin description

Pin number	Signal name	Signal type	Signal description
1	AVDDVCSEL	Supply	VCSEL supply, to be connected to main supply
2	AVSSVCSEL	Ground	VCSEL ground, to be connected to main ground
3	GND		To be connected to the main ground
4	GND2		To be connected to the main ground
5	XSHUT	Digital input	Xshutdown pin, active low
6	GND3	Ground	To be connected to the main ground
7	GPIO1	Digital output	Interrupt output. Open drain output
8	DNC	Digital input	Do not connect, must be left floating
9	SDA	Digital input/output	I ² C serial data
10	SCL	Digital input	I ² C serial clock input
11	AVDD	Supply	Supply, to be connected to the main supply
12	GND4	Ground	To be connected to the main ground

Note: AVSSVCSEL and GND are ground pins that can be connected in the application schematics.

Note: GND2, GND3, and GND4 are standard pins that are forced to the ground domain in the application schematics. This is to avoid possible instabilities, which might arise if set in other states.

2.4 Application schematic

The following figure shows the application schematic of the VL53L0X.

Figure 3. VL53L0X schematic

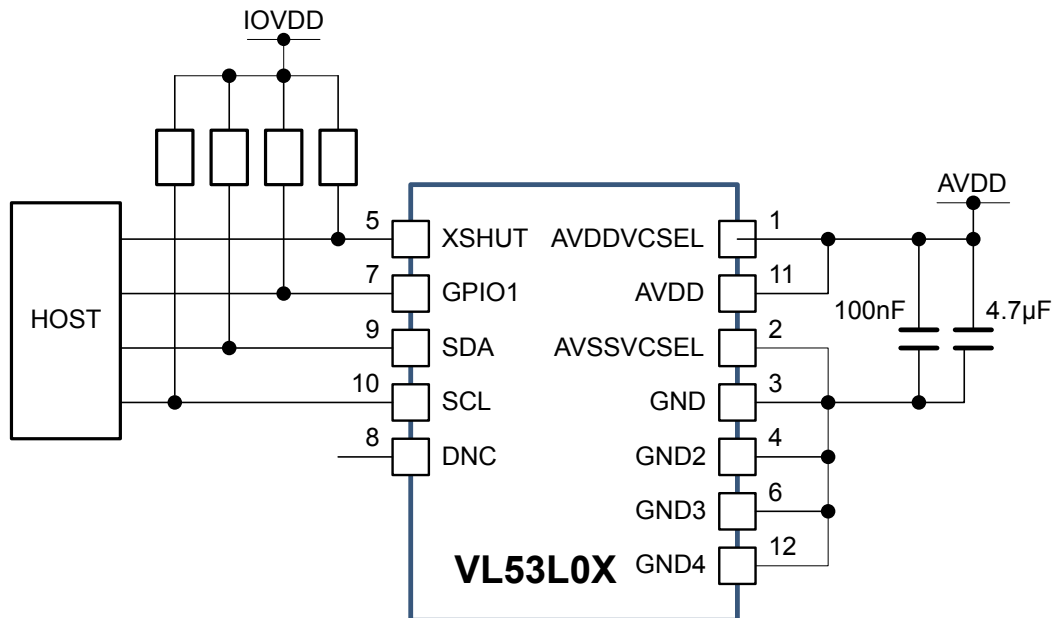

Note: Capacitors on the external supply AVDD should be placed as close as possible to the AVDDVCSEL and AVSSVCSEL module pins.

Note: The external pull-up resistor values can be found in the I²C-bus specification. Pull-ups are typically fitted only once per bus, near the host. Recommended values for pull-up resistors for an AVDD of 2.8 V and a 400 kHz I²C clock are 1.5 k to 2 kOhms

Note: The XSHUT pin must always be driven to avoid leakage current. A pull-up is needed if the host state is not known. XSHUT is needed to use hardware standby mode (there is no I²C communication).

Note: The recommended value of the XSHUT and GPIO1 pull-ups is 10 kOhms.

Note: The GPIO1 should be left unconnected if not used.

3 Functional description

3.1 System functional description

Figure 4. VL53L0X system functional description shows the system level functional description. The host customer application controls the VL53L0X device using an API (application programming interface).

The API exposes to the customer application a set of high level functions that allow control of the VL53L0X firmware (FW). Functions include initialization/calibration, ranging start/stop, choice of accuracy, and choice of ranging mode.

The API is a turnkey solution. It consists of a set of C functions which enables fast development of end user applications, without the complication of direct multiple register access. The API is structured in a way that it can be compiled on any kind of platform through a well isolated platform layer.

The API package allows the user to fully benefit from the VL53L0X capabilities.

A detailed description of the API is available in the VL53L0X API user manual (UM2039).

VL53L0X FW fully manages the hardware (HW) register accesses.

Section 3.2: Firmware state machine description details the firmware state machine.

Figure 4. VL53L0X system functional description

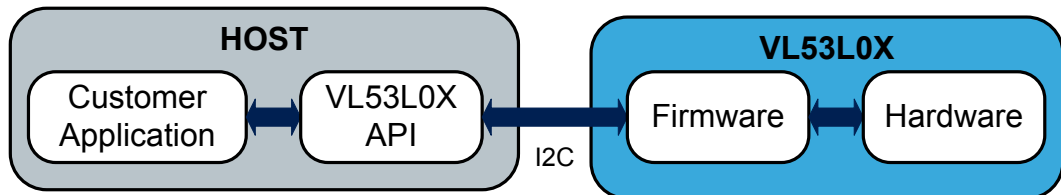

3.2 Firmware state machine description

The following figure shows the device state machine.

Figure 5. Firmware state machine

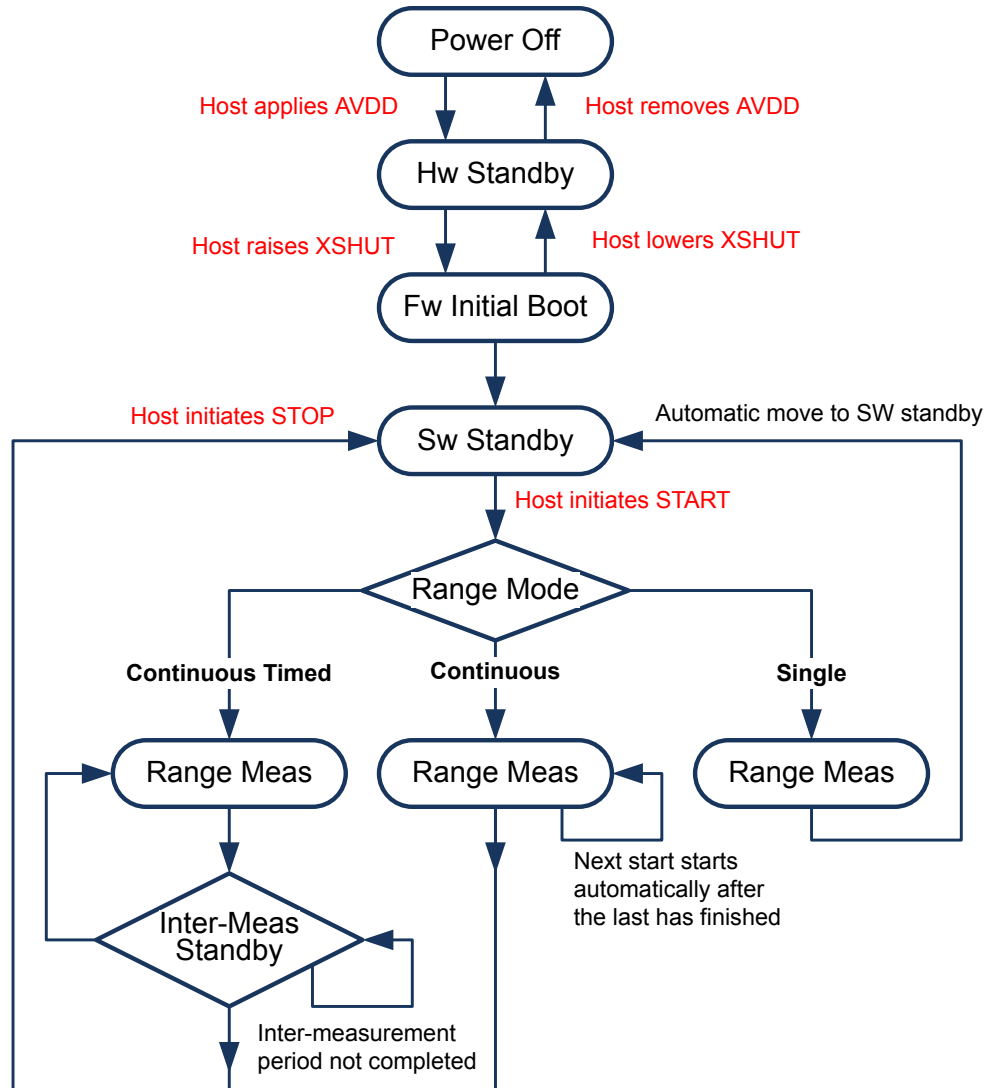

3.3 Customer manufacturing calibration flow

Figure 6. Customer manufacturing calibration flow shows the recommended calibration flow that should be applied at customer and factory level, once only. This flow takes into account all parameters (cover glass, temperature, and voltage) from the application.

Figure 6. Customer manufacturing calibration flow

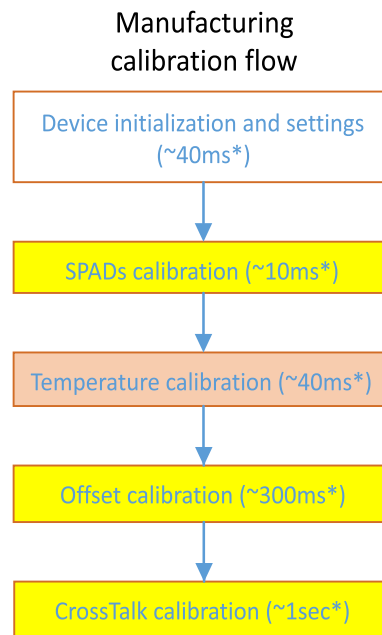

* : Timings are given for information only, they can vary depending on the Host capabilities

Initialisation -
to be called once after device reset

Initial calibration - required only once,
host to store values.

Calibration step to be repeated with
> 8 degreeC temperature change.

3.3.1 SPAD and temperature calibration

To optimize the dynamics of the system, the reference SPADs have to be calibrated. Reference SPAD calibration needs to be done only once during the initial manufacturing calibration. The calibration data should then be stored on the host.

Temperature calibration is the calibration of two parameters (VHV and phase cal) which are temperature dependent. These two parameters are used to set the device sensitivity. Calibration should be performed during initial manufacturing calibration. It must be performed again when the temperature varies more than 8°C compared to the initial calibration temperature.

For more details on SPAD and temperature calibration, refer to the VL53L0X API user manual (UM2039).

3.3.2 Ranging offset calibration

Ranging offset is characterized by the mean offset, which is the centering of the measurement versus the real distance.

Offset calibration should be performed at the factory for optimal performance. It is recommended at 10 cm. The offset calibration should consider:

- The supply voltage and temperature.
- The protective cover glass above the VL53L0X module.

Figure 7. Range offset

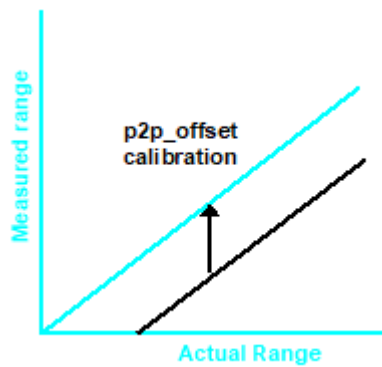

3.3.3 Crosstalk calibration

Crosstalk is defined as the signal return from the cover glass. The magnitude of the crosstalk depends on the type of glass and air gap. Crosstalk results in a range error. This is proportional to the ratio of the crosstalk to the signal return from the target.

Figure 8. Crosstalk compensation

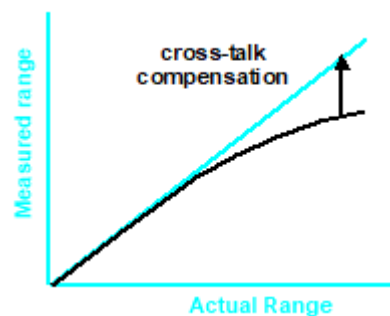

The full offset and crosstalk calibration procedures are described in the VL53L0X API user manual (UM2039).

3.4 Ranging operating modes

There are three ranging modes available in the API:

1. Single ranging
Ranging is performed only once after the API function is called. The system returns to SW standby automatically.
2. Continuous ranging.
Ranging is performed in a continuous way after the API function is called. As soon as the measurement is finished, another one is started without delay. The user has to stop the ranging to return to SW standby. The last measurement is completed before stopping.
3. Timed ranging.
Ranging is performed in a continuous way after the API function is called. When a measurement is finished, another one is started after a user-defined delay. This delay (intermeasurement period) can be defined through the API.

The user has to stop the ranging to return to SW standby.

If the stop request comes during a range measurement, the measurement is completed before stopping. If it happens during an intermeasurement period, the range measurement stops immediately.

3.5 Ranging profiles

There are four different ranging profiles available via the API example code. Customers can create their own ranging profile dependent on their use case and performance requirements. For more details, refer to the VL53L0X API user manual (UM2039).

- Default mode
- High speed
- High accuracy
- Long range

3.6 Ranging profile phases

Each range profile consists of three consecutive phases:

- Initialization and load calibration data
- Ranging
- Digital housekeeping

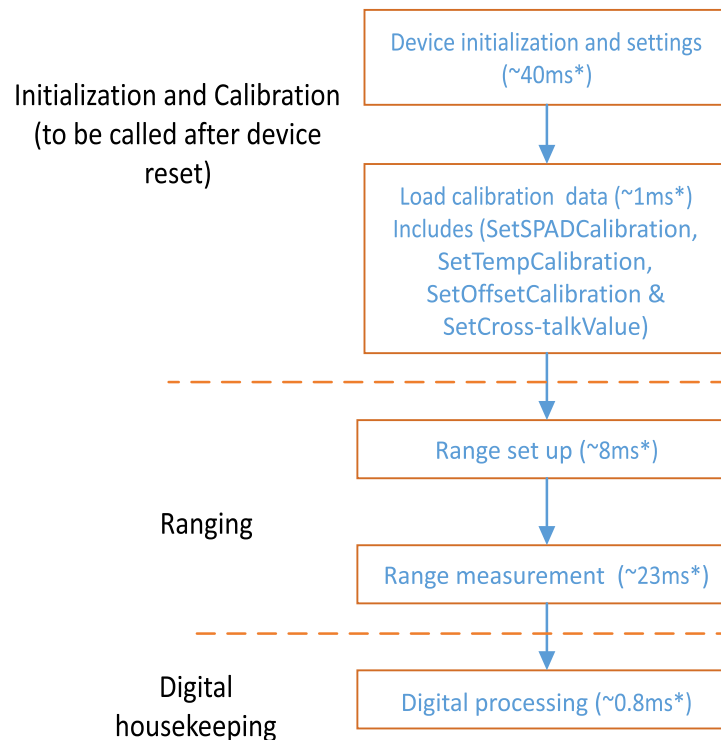
Figure 9. Typical initialization/ranging/housekeeping phases

* : Timings are given for information only, they can vary depending on the Host capabilities

3.6.1 Initialization and load calibration data phase

The initialization and calibration phase is performed before the first ranging, or after a device reset (see [Figure 9. Typical initialization/ranging/housekeeping phases](#)). The user may then have to repeat the temperature calibration phase in a periodic way, depending on the use case.

For more details on the calibration functions, refer to the VL53L0X API user manual (UM2039).

3.6.2 Ranging phase

The ranging phase consists of a range setup, and then a range measurement.

During the ranging operation, several VCSEL infrared pulses are emitted. They are then reflected back by the target object, and detected by the receiving array. The photo detector used inside VL53L0X uses advanced ultrafast SPAD technology, which is protected by several patents.

The typical timing budget for a range is 33 ms using init/ranging/housekeeping (see [Figure 12. Ranging sequence](#)). The actual range measurement takes 23 ms (see [Figure 9. Typical initialization/ranging/housekeeping phases](#)). The minimum range measurement period is 8 ms.

3.6.3 Digital housekeeping

Digital processing (housekeeping) is the last operation inside the ranging sequence that computes, validates, or rejects a ranging measurement. Part of this processing is performed internally while the other part is executed on the host by the API.

At the end of the digital processing, the ranging distance is computed by VL53L0X itself. If the distance cannot be measured (for example, a weak signal, or no target), a corresponding error code is provided.

The following functions are performed on the device itself:

- Signal value check (weak signal)
- Offset correction
- Crosstalk correction (in case of cover glass)
- Final ranging value computation

The above functions are performed while the API performs the following:

- RIT check (signal check versus crosstalk)
- Sigma check (accuracy condition)
- Final ranging state computation

If the user wants to enhance the ranging accuracy, some extra processing (which is not part of the API) can be carried out by the host. For example, rolling average, hysteresis or any kind of filtering.

3.7 Getting the data: Interrupt or polling

The user can get the final data using a polling or an interrupt mechanism.

Polling mode

The user has to check the status of the ongoing measurement by polling an API function.

Interrupt mode

An interrupt pin (GPIO1) sends an interrupt to the host when a new measurement is available.

The description of these two modes is available in the VL53L0X API user manual (UM2039).

3.8 Device programming and control

The I²C is the physical control interface of the device. It is described in [Section 4: Control interface](#).

A software layer (API) is also provided to control the device. The API is described in the VL53L0X API user manual (UM2039).

3.9 Power sequence

There are two options available for device power-up and boot sequence.

Note: In all cases, XSHUT is raised only when AVDD is tied on.

Option 1

The XSHUT pin is connected and controlled from the host.

This option optimizes power consumption. The device can be completely powered off when not used, and then woken up through the host (using the XSHUT pin).

Hardware standby mode is the period when the AVDD is present and the XSHUT is low.

Figure 10. Power-up and boot sequence

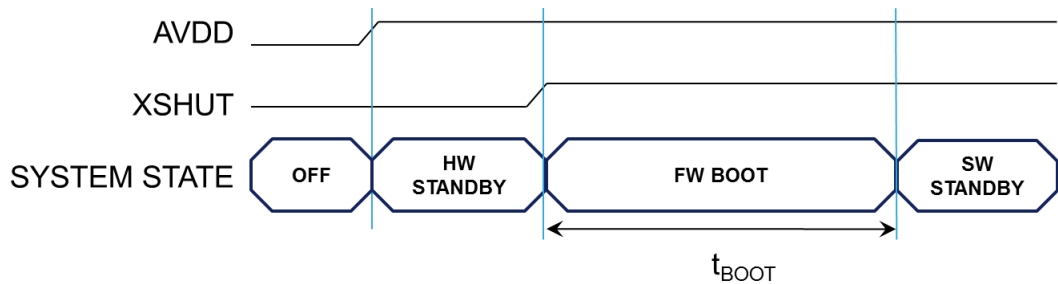

Note: t_{BOOT} is 1.2 ms maximum.

Option 2

The host does not control the XSHUT pin. This pin is tied to AVDD through a pull-up resistor.

When the XSHUT pin is not controlled, the power-up sequence is as shown in the following figure. In this case, the device goes automatically to software standby after a firmware boot, without entering hardware standby.

Figure 11. Power-up and boot sequence with XSHUT not controlled

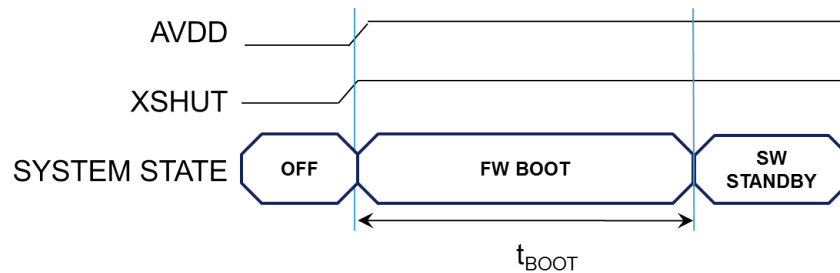

Note: t_{BOOT} is 1.2 ms maximum.

3.10 Ranging sequence

Figure 12. Ranging sequence

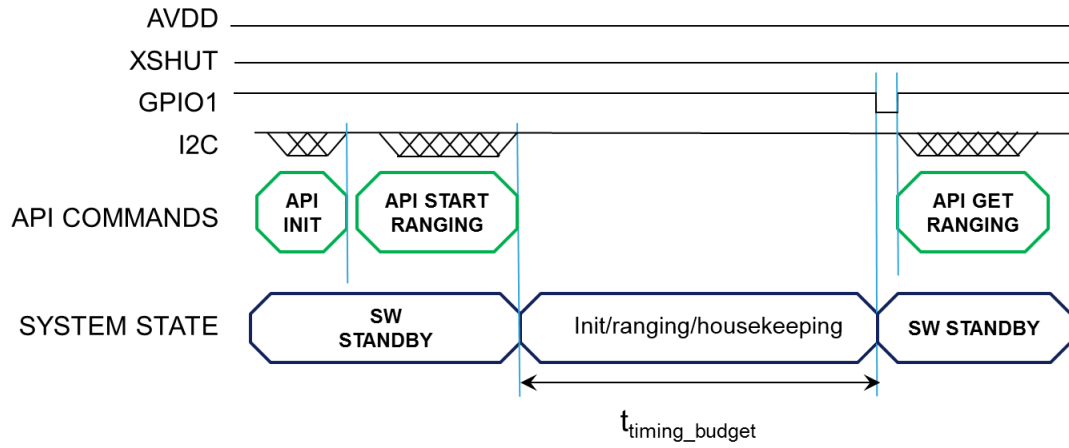

Note: The $t_{\text{timing_budget}}$ is a parameter set by the user, using a dedicated driver function. The default value is 33 ms.

4 Control interface

This section specifies the control interface. The I²C interface uses two signals: serial data line (SDA) and serial clock line (SCL). Each device connected to the bus uses a unique address and a simple controller/target relationship exists.

Both SDA and SCL lines are connected to a positive supply voltage using pull-up resistors located on the host. Lines are only actively driven low. A high condition occurs when lines are floating and the pull-up resistors pull lines up. When no data is transmitted both lines are high.

Clock signal generation is performed by the controller device. The controller device initiates data transfer. The I²C bus has a maximum speed of 400 kbits/s and uses a default device address of 0x52.

Figure 13. Data transfer protocol

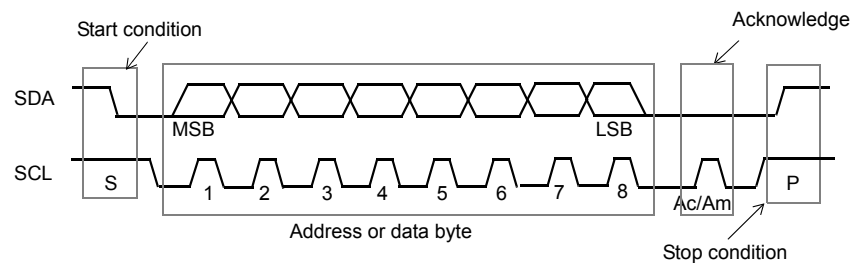

Information is packed in 8-bit packets (bytes) and is always followed by an acknowledge bit, Ac for the VL53L0X acknowledge and Am for the controller acknowledge (host bus controller). The internal data are produced by sampling SDA at a rising edge of SCL. The external data must be stable during the high period of SCL. The exceptions to this are start (S) or stop (P) conditions when SDA falls or rises respectively, while SCL is high.

A message contains a series of bytes preceded by a start condition, and followed by either a stop or repeated start (another start condition but without a preceding stop condition), followed by another message. The first byte contains the device address (0x52) and also specifies the data direction. If the least significant bit is low (that is, 0x52) the message is a controller write-to-the-target. If the LSB is set (that is, 0x53) then the message is a controller read-from-the-target.

Figure 14. I²C device address: 0x52

MSBit							LSBit
0	1	0	1	0	0	1	R/W

All serial interface communications with the Time-of-Flight sensor must begin with a start condition. The VL53L0X module acknowledges the receipt of a valid address by driving the SDA wire low. The state of the read/write bit (LSB of the address byte) is stored and the next byte of data, sampled from SDA, can be interpreted. During a write sequence, the second byte received provides an 8-bit index, which points to one of the internal 8-bit registers.

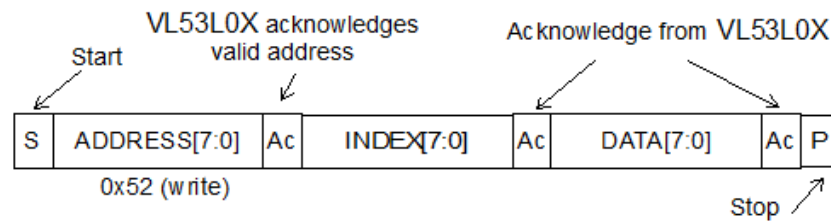
Figure 15. Data format (write)

As data are received by the target, they are written bit by bit to a serial/parallel register. After each data byte has been received by the target, an acknowledge is generated, the data are then stored in the internal register addressed by the current index.

During a read message, the contents of the register addressed by the current index is read out in the byte following the device address byte. The contents of this register are parallel loaded into the serial/parallel register and clocked out of the device by the falling edge of SCL.

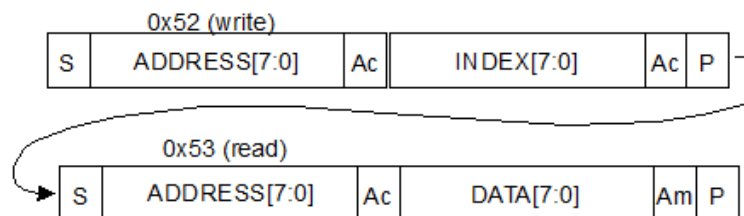
Figure 16. Data format (read)

At the end of each byte, in both read and write message sequences, an acknowledge is issued by the receiving device (that is, the VL53L0X for a write, and the host for a read).

A message can only be terminated by the bus controller, either by issuing a stop condition or by a negative acknowledge (that is, not pulling the SDA line low) after reading a complete byte during a read operation.

The interface also supports auto increment indexing. After the first data byte has been transferred, the index is automatically incremented by 1. The controller can therefore send data bytes continuously to the target until the target fails to provide an acknowledge, or the controller terminates the write communication with a stop condition. If the auto increment feature is used, the controller does not have to send address indexes to accompany the data bytes.

Figure 17. Data format (sequential write)

Figure 18. Data format (sequential read)

4.1 I²C interface - timing characteristics

Timing characteristics are shown in the following table. Refer to Figure 19. I²C timing characteristics for an explanation of the parameters used.

Timings are given for all PVT conditions.

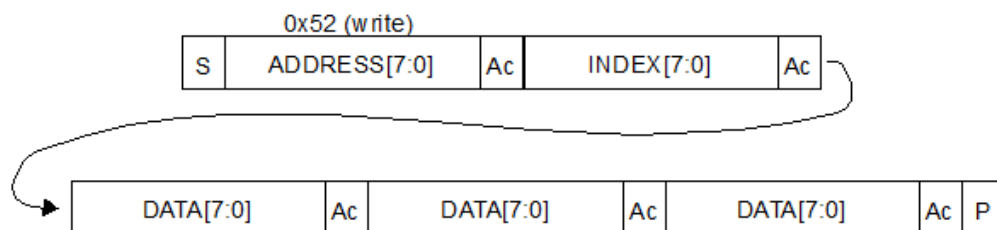
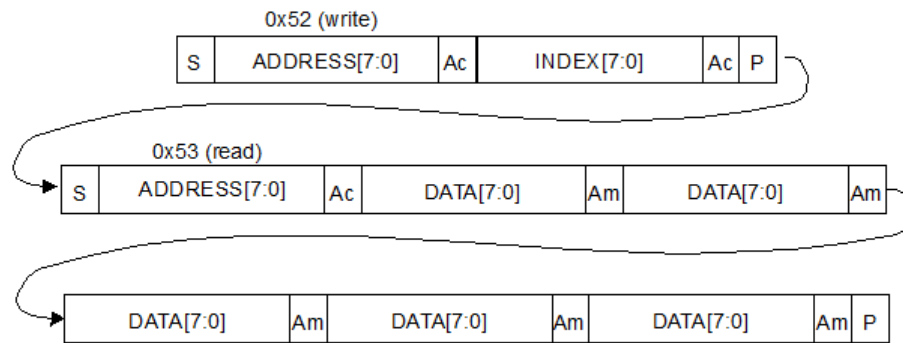
Table 4. I²C interface - timing characteristics

Symbol	Parameter	Minimum	Typical	Maximum	Unit
F _{I2C}	Operating frequency (standard and fast mode)	0	—	400 ⁽¹⁾	kHz
t _{LOW}	Clock pulse width low	1.6	—	—	
t _{HIGH}	Clock pulse width high	0.6	—	—	μs
t _{SP}	Pulse width of spikes that are suppressed by the input filter	—	—	50	ns
t _{BUF}	Bus free time between transmissions	1.3	—	—	ms
t _{HD.STA}	Start hold time	0.26	—	—	μs
t _{SU.STA}	Start setup time	0.26	—	—	
t _{HD.DAT}	Data in hold time	0	—	0.9	
t _{SU.DAT}	Data in setup time	50	—	—	ns
t _R	SCL/SDA rise time	—	—	120	
t _F	SCL/SDA fall time	—	—	120	
t _{SU.STO}	Stop setup time	0.6	—	—	μs
C _{i/o}	Input/output capacitance (SDA)	—	—	10	pF
C _{in}	Input capacitance (SCL)	—	—	4	
C _L	Load capacitance	—	125	400	

1. The maximum bus speed is also limited by the combination of a 400 pF load capacitance and a pull-up resistor. Refer to the I²C specification for further information

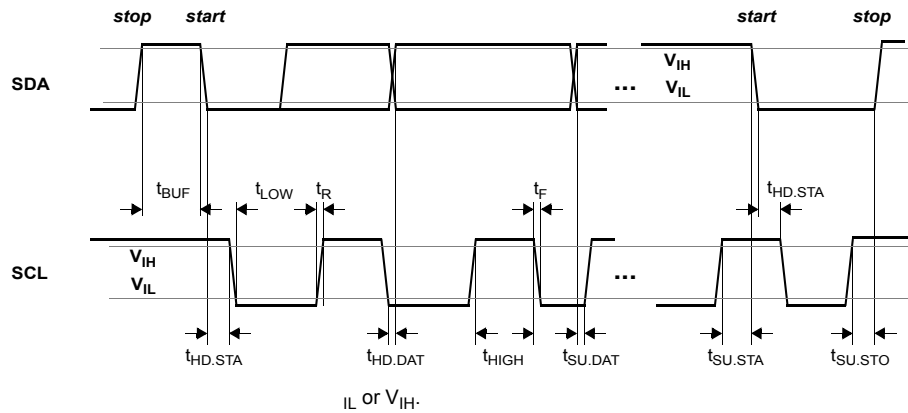
Figure 19. I²C timing characteristics

All timings are measured from either V_{IL} or V_{IH} .

4.2 I²C interface - reference registers

The registers shown in the table below can be used to validate the user I²C interface.

Table 5. Reference registers

Address	After fresh reset, without the API loaded
0xC0	0xEE
0xC1	0xAA
0xC2	0x10
0X51	0x0099
0x61	0x0000

Note: The I²C read/writes can be 8, 16, or 32-bit. Multibyte read/writes are always addressed in ascending order with the MSB first as shown in the following table.

Table 6. 32-bit register example

Register address	Byte
Address	MSB
Address + 1	...
Address + 2	...
Address + 3	LSB

5 Electrical characteristics

5.1 Absolute maximum ratings

Warning: Stresses above those listed in the following table may cause permanent damage to the device. These are stress ratings only. Functional operation of the device is not implied at these or any other conditions above those indicated in the operational sections of the specification. Exposure to absolute maximum rating conditions for extended periods may affect device reliability.

Table 7. Absolute maximum ratings

Parameter	Min.	Typ.	Max.	Unit
AVDD	-0.5	—	3.6	V
SCL, SDA, XSHUT, and GPIO1				

5.2 Recommended operating conditions

There are no power supply sequencing requirements. The I/Os may be high, low, or floating when AVDD is applied. The I/Os are internally failsafe with no diode connecting them to AVDD.

Table 8. Recommended operating conditions

Parameter	Min.	Typ.	Max.	Unit
Voltage (AVDD)	2.6	2.8	3.5	V
IO (IOVDD) ⁽¹⁾	Standard mode	1.6	1.8	
	2V8 mode ^{(2) (3)}	2.6	2.8	
Normal operating temperature	-20	—	70	°C

1. XSHUT should be high only when AVDD is on.

2. SDA, SCL, XSHUT, and GPIO1 high levels have to be equal to AVDD in 2V8 mode.

3. The default API mode is 1V8. 2V8 mode is programmable using the device settings loaded by the API. For more details refer to the VL53L0X API user manual (UM2039).

5.3 Electrostatic discharge

The VL53L0X is compliant with the ESD values presented in the following table.

Table 9. ESD performances

Parameter	Specification	Conditions
Human body model	JS-001-2012	± 2 kV, 1500 ohms, 100 pF
Charged device model	JESD22-C101	± 500 V

5.4 Current consumption

Table 10. Consumption at ambient temperature

All current consumption values include silicon process variations. Temperature and voltage are nominal conditions (23°C and 2.8 V). All values include AVDD and AVDDVCSEL.

Parameter	Min.	Typ.	Max.	Unit
HW STANDBY	3	5	7	μA
SW STANDBY (2V8 mode) ⁽¹⁾	4	6	9	
Timed ranging intermeasurement	—	16	—	
Active ranging average consumption (including VCSEL) ^{(2) (3)}	—	19	—	mA
Average power consumption at 10 Hz with 33 ms ranging sequence	—	—	20	

1. In standard mode (1V8), pull-ups have to be modified. Then the SW STANDBY consumption is increased by 0.6 μA.
2. Active ranging is an average value, measured using the default API settings (33 ms timing budget).
3. Peak current (including VCSEL) can reach 40 mA.

5.5 Digital input and output

Table 11. Digital I/O electrical characteristics

Symbol	Parameter	Min.	Typ.	Max.	Unit
Interrupt pin (GPIO1)					
VIL	Low level input voltage	—	—	0.3 IOVDD	V
VIH	High level input voltage	0.7 IOVDD		—	
VOL	Low level output voltage (IOUT = 4 mA)	—		0.4	
VOH	High level output voltage (IOUT = 4 mA)	IOVDD-0.4		—	
FGPIO	Operating frequency (CLOAD = 20 pF)	0		108	MHz
I ² C interface (SDA/SCL)					
VIL	Low level input voltage	-0.5	—	0.6	V
VIH	High level input voltage	1.12		3.5	
VOL	Low level output voltage (IOUT = 4 mA in standard and fast modes)	—		0.4	
IIL/IH	Leakage current ⁽¹⁾	—		10	
	Leakage current ⁽²⁾	—		0.15	

1. AVDD = 0 V
2. AVDD = 2.85 V, and I/O voltage = 1.8 V

6 Performance

6.1 Measurement conditions

In all the measurement tables of this document, it is considered that the full FoV is covered.

The VL53L0X system FoV is 25°.

Reflectance targets are standard ones (gray 17% N4.74 and White 88% N9.5 Munsell charts).

Unless mentioned, the device is controlled through the API using the default settings. Refer to the VL53L0X API user manual (UM2039) for API setting descriptions.

Figure 20. Typical ranging (default mode)

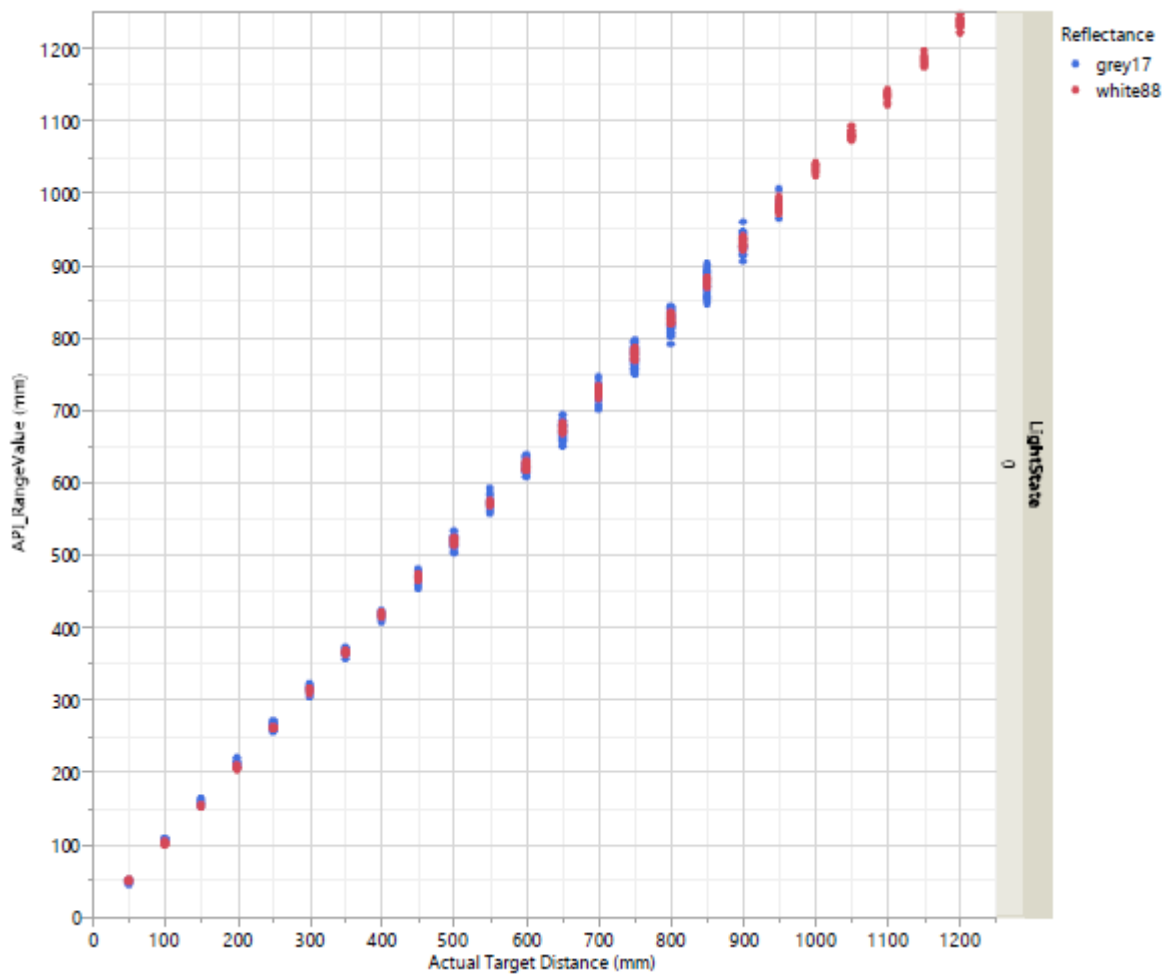
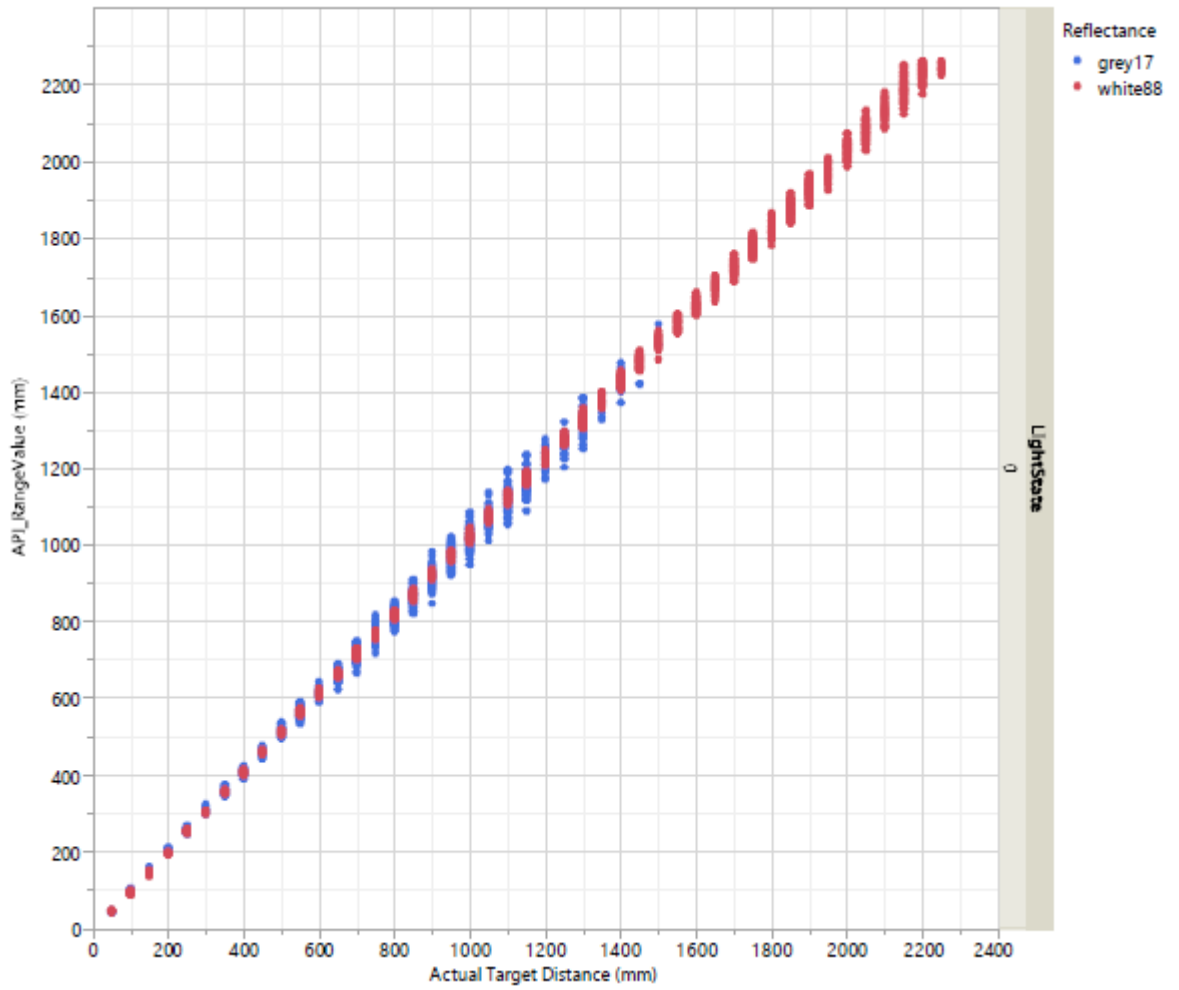

Figure 21. Typical ranging - long range mode



6.2 Maximum ranging distance

The table below shows the ranging specification for the VL53L0X bare module. This is without a cover glass, at room temperature (23°C), and with nominal voltage (2.8 V).

Table 12. Maximum ranging capabilities with a 33 ms timing budget

Target reflectance level, full FoV	Conditions	Indoor ⁽¹⁾	Outdoor ⁽¹⁾
White target (88%)	Typical	200 cm+ ⁽²⁾	80 cm
	Minimum	120 cm	60 cm
Gray target (17%)	Typical	80 cm	50 cm
	Minimum	70 cm	40 cm

1. Indoor corresponds to no infrared. Outdoor overcast corresponds to a parasitic noise of 10 kcps/SPAD for the VL53L0X module. For reference, this corresponds to a 1.2 W/m² at 940 nm, and is equivalent to 5 klx daylight, while ranging on a gray 17% chart at 40 cm.

2. Using a long range API profile.

Measurement conditions

- Target reflectance used: Gray (17%), White (88%)
- Nominal voltage (2.8 V) and temperature (23°C)
- All distances are for a complete FoV covered (FoV = 25°)

All distances mentioned in the above table are guaranteed for a minimum detection rate of 94% (up to 100%). The detection rate is the worst case percentage of measurements that return a valid measurement when the target is detected.

6.3 Ranging accuracy

6.3.1 Standard deviation

The ranging accuracy can be characterized by the standard deviation. It includes measure-to-measure and part-to-part (silicon) dispersion.

Table 13. Ranging accuracy

Target reflectance level, full FoV	Indoor (no infrared)			Outdoor		
	Distance	33 ms	66 ms	Distance	33 ms	66 ms
White target (88%)	At 120 cm	4%	3%	At 60 cm	7%	6%
Gray target (17%)	At 70 cm	7%	6%	At 40 cm	12%	9%

Measurement conditions

- Target reflectance used: Gray (17%), White (88%)
- Offset correction done at 10 cm from sensor
- Indoor: No infrared
- Outdoor: 5 klx equivalent sunlight (10 kcps/SPAD)
- Nominal voltage (2.8 V) and temperature (23°C)
- All distances are for a complete FoV covered (FoV = 25°)
- Detection rate is considered at 94% minimum

6.3.2 Range profile examples

The following table shows the typical performance for the four example ranging profiles, as per Section 6.1: Measurement conditions.

Table 14. Range profiles

Range profile	Range timing budget	Typical performance	Typical application
Default mode	30 ms	1.2 m, accuracy as per Table 13. Ranging accuracy	Standard
High accuracy	200 ms	1.2 m, accuracy < $\pm 3\%$	Precise measurement
Long range	33 ms	1.2 m, accuracy as per Table 13. Ranging accuracy	Long ranging, only for dark conditions (no IR)
High speed	20 ms	1.2 m, accuracy $\pm 5\%$	High speed where accuracy is not a priority

6.3.3 Ranging offset error

The table below shows how range offset may drift over distance, voltage, and temperature. We assume that the offset has been calibrated at 10 cm. See the VL53L0X API user manual (UM2039) for details on offset calibration.

Table 15. Range profiles

	Nominal conditions	Measure point	Typical offset from nominal	Maximum offset from nominal
Ranging distance	Offset calibration at 10 cm ("zero")	White 120 cm (indoor) Gray 70 cm (indoor) White 60 cm (outdoor) Gray 40 cm (outdoor)	—	<3%
Voltage drift	2.8 V	2.6 V to 3.5 V	± 10 mm	± 15 mm
Temperature drift	23°C	-20°C to 70°C	± 10 mm	± 30 mm

7 Outline drawings

Figure 22. Outline drawing (1/3)

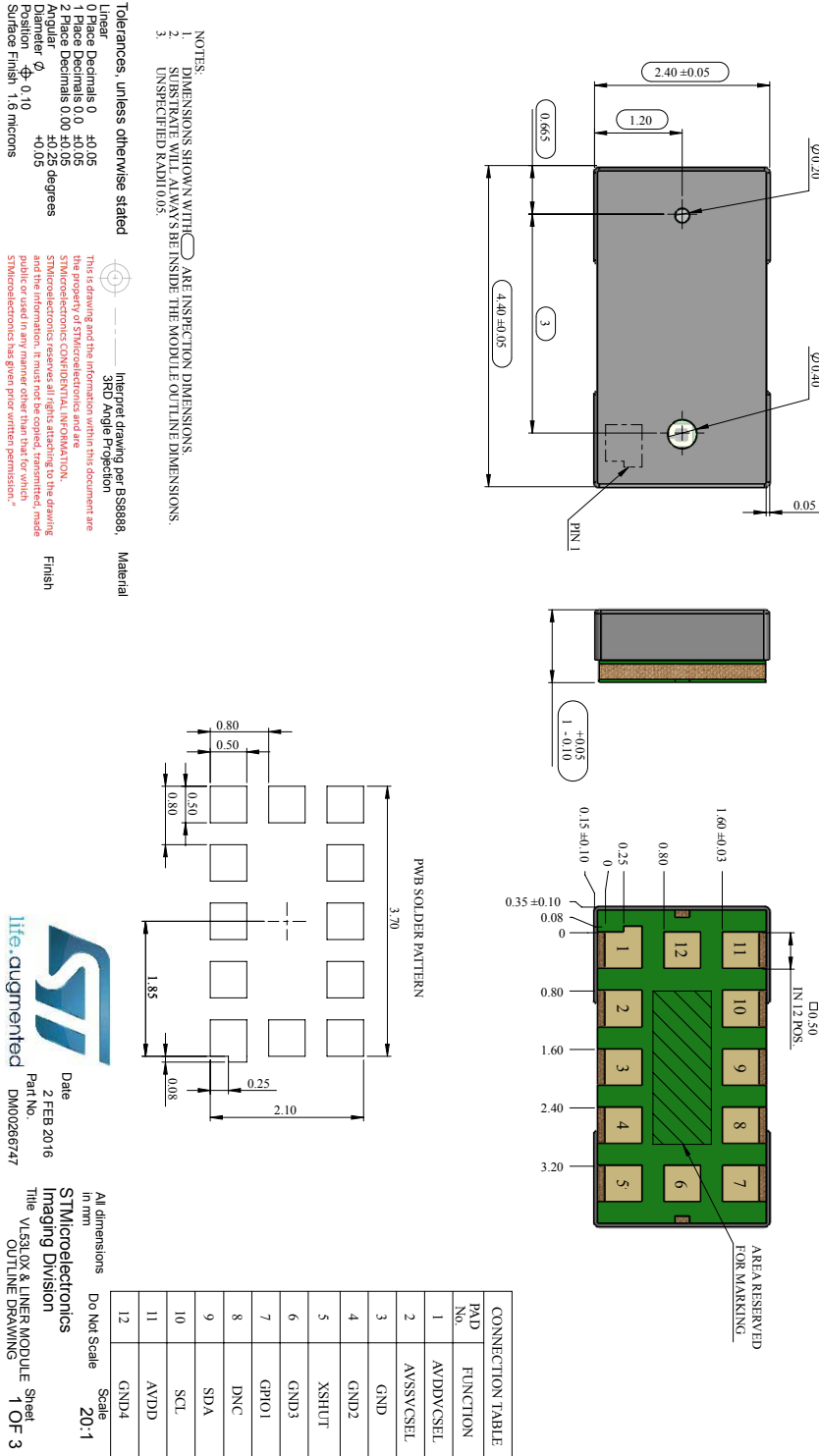

REVISION TABLE		DATE
REV.	DESCRIPTION	
1	INITIAL RELEASE	06/02/2016
2	DRAWING TITLE UPDATE	04/05/2016

Tolerances, unless otherwise stated

Linear 0 ±0.05
1 Place Decimals 0.0 ±0.05
2 Place Decimals 0.00 ±0.05
Angular ±0.25 degrees
Diameter \varnothing ±0.05
Surface Finish 1.6 microns

Interpret drawing per B39898, Material 3RD Angle Projection

This is drawing and the information within this document are the property of STMicroelectronics and are STMicroelectronics CONFIDENTIAL INFORMATION. STMicroelectronics reserves all rights attaching to the drawing and the information. It must not be copied, transmitted, made public or used in any way without the prior written permission of STMicroelectronics.

Date 2 FEB 2016
Part No. DM00266747

All dimensions in mm
STMicroelectronics Imaging Division
Title VL53L0X & LINEAR MODULE SHEET
OUTLINE DRAWING 1 OF 3

Do Not Scale Scale 20:1

Figure 23. Outline drawing (2/3)

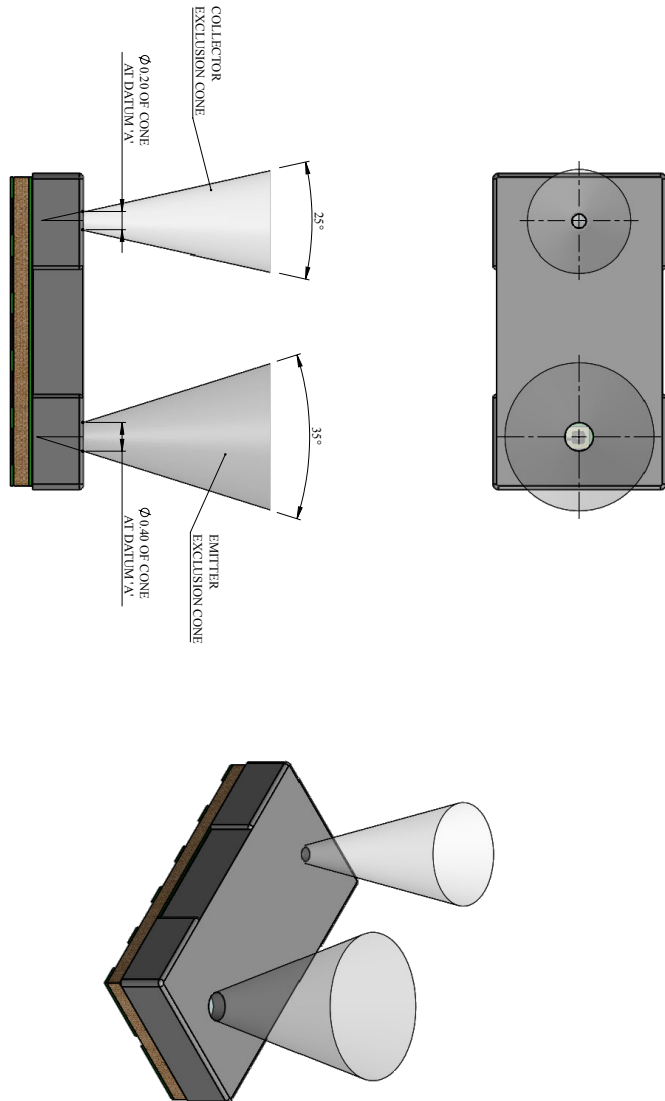

REV	1
-----	---

EXCLUSION CONE DATA:
THE TWO CONES SHOWN ON THIS SHEET REPRESENT
VOLUMES INTO WHICH THE USER'S EQUIPMENT
HOUSING SHOULD NOT ENTER.

Tolerances, unless otherwise stated

Linear		
0 Place Decimals	0	±0,05
1 Place Decimals	0	±0,05
2 Place Decimals	0,00	±0,25 degrees
Angular	0,00	+0,05
Diameter \varnothing		
Position \varnothing	0,10	
Surface Finish	1,6 microns	



Interpret drawing per BS8888, 3RD Angle Projection

This is drawing and the information within this document are the property of STMicroelectronics and are not to be reproduced, stored in a retrieval system, transmitted, in any form or by any means, electronic, mechanical, photocopying, recording, or by any information storage and retrieval system, without the prior written permission of STMicroelectronics. It must not be copied, transmitted, made public or used in any manner other than that for which STMicroelectronics has given prior written permission.

Material

Finish

life augmented Part No. DW00266747

Date: 2 FEB 2016
All dimensions in mm Do Not Scale Scale: 20:1
STMicroelectronics
Imaging Division
Title: VL53L0X & LINER MODULE SHEET
OUTLINE DRAWING 2 OF 3

Figure 24. Outline drawing - option with liner (3/3)

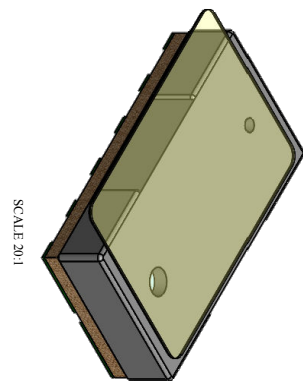
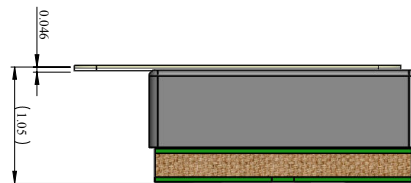
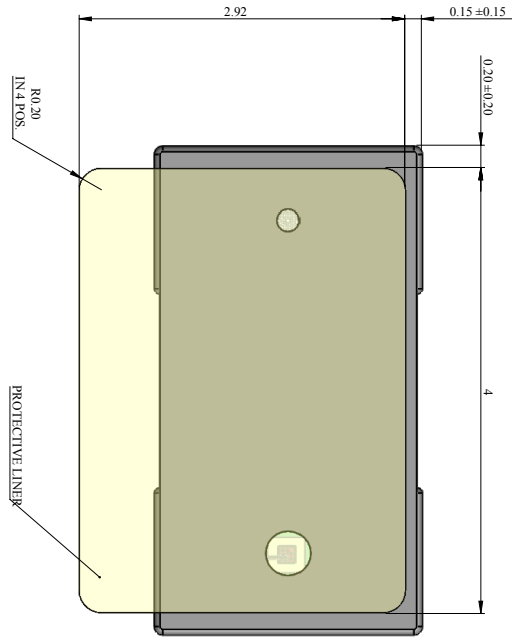

REV	1
-----	---

Tolerances, unless otherwise stated

Linear	Material
0 Place Decimals 0	+0.05
1 Place Decimals 0.0	+0.05
2 Place Decimals 0.00	+0.05
Angular	+0.25 degrees
Parallel \parallel	+0.05
Surface Finish \sqrt{Ra}	1.8 microns

Interpret drawing per BS8888, 3RD Angle Projection

This is drawing and the information within this document are the property of STMicroelectronics and are STMicroelectronics CONFIDENTIAL INFORMATION. STMicroelectronics reserves all rights attaching to the drawing and the information. It must not be copied, transmitted, made public or used in any manner other than that for which STMicroelectronics has given prior written permission.



Date: 2 FEB 2016
Part No.: DM00266747

All dimensions in mm Do Not Scale Scale: 30:1

STMicroelectronics Imaging Division
Title: VL53L0X & LINER MODULE SHEET
OUTLINE DRAWING 3 OF 3

8 Laser safety

This product contains a laser emitter and corresponding drive circuitry. The laser output is designed to meet Class 1 laser safety limits under all reasonably foreseeable conditions including single faults in compliance with IEC 60825-1:2014.

Do not increase the laser output power by any means. Do not use any optics to focus the laser beam.

Caution: Use of controls or adjustments, or performance of procedures other than those specified herein may result in hazardous radiation exposure.

Figure 25. Class 1 laser label



This product complies with:

- IEC 60825-1:2014
- 21 CFR 1040.10 and 1040.11, except for conformance with IEC 60825-1:2014 as described in the laser notice number 56, dated May 8, 2019.
- EN 60825-1:2014 including EN 60825-1:2014/A11:2021
- EN 50689:2021, however STMicroelectronics does not guarantee compliance with the requirement of clause 5 from EN50689 regarding child appealing products. If designing a child appealing product, contact STMicroelectronics' technical application support.

9 Packaging and labeling

9.1 Product marking

A two line product marking is applied on the backside of the module (on the substrate). The first line is the silicon product code, and the second line, the internal tracking code.

9.2 Inner box labeling

The labeling follows the STMicroelectronics' standard packing acceptance specification.

The following information is on the inner box label:

- Assembly site
- Sales type
- Quantity
- Trace code
- Marking
- Bulk ID number

9.3 Packing

At customer/subcontractor level, it is recommended to mount the VL53L0X in a clean environment to avoid foreign material deposition.

To help avoid any foreign material contamination at phone assembly level the modules are shipped in a tape and reel format. The packaging is vacuum-sealed and includes a desiccant.

Note: For sensors with the liner option, the liner must be removed during assembly of the customer device, just before mounting the cover glass. The liner is compliant with a reflow at 260°C (as per JEDEC-STD-020E).

9.3.1 Tape outline drawing

The pictures below show the tape outline drawings for modules without and with liner. The pin1 of the module is referenced by a red star in the figures.

Figure 26. Tape outline drawing - option modules without liner

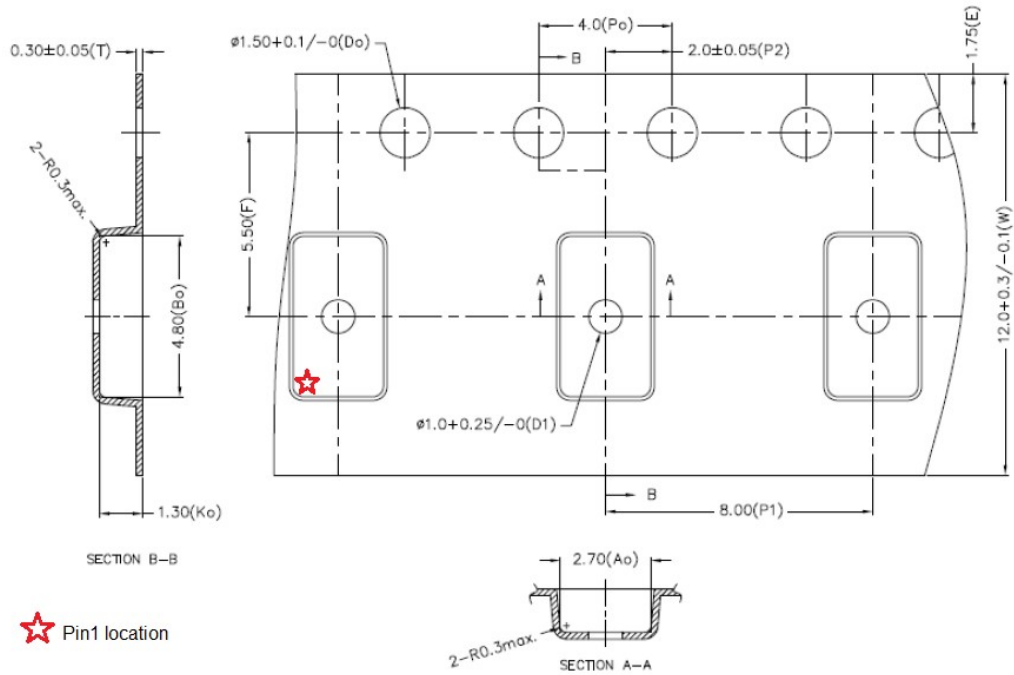
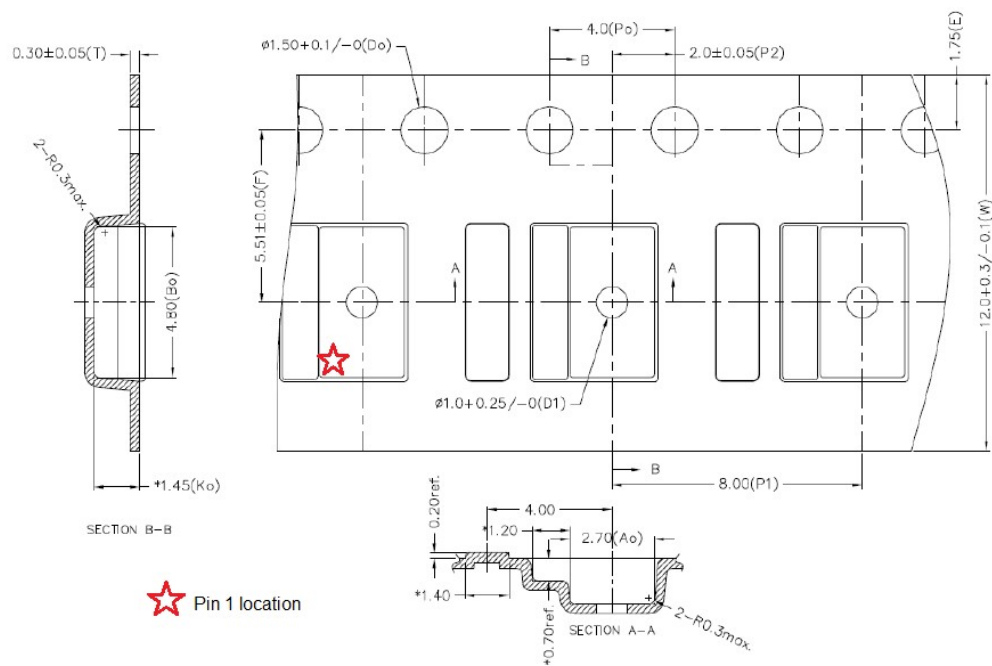

Figure 27. Tape outline drawing - option modules with liner



9.4 Pb-free solder reflow process

Table 16. Recommended solder profile and Figure 28. Solder profile show the recommended and maximum values for the solder profile.

Customers have to tune the reflow profile depending on the PCB, solder paste, and material used. We expect customers to follow the recommended reflow profile, which is specifically tuned for the VL53L0X package.

If a customer must perform a reflow profile, which is different from the recommended one, the new profile must be qualified by the customer at their own risk. This is especially true for peaks $>240^{\circ}\text{C}$. In any case, the profile must be within the “maximum” profile limit described in Table 16. Recommended solder profile.

Note: Temperatures mentioned in the table below are measured at the top of the VL53L0X package.

Table 16. Recommended solder profile

Parameters	Recommended	Maximum	Unit
Minimum temperature (TS min)	130	150	°C
Maximum temperature (TS max)	200	200	
Time t_s (TS min to TS max)	90-110	60-120	s
Temperature (TL)	217	217	°C
Time (tL)	55-65	55-65	s
Ramp up	2	3	°C/s
Temperature (Tp-10)	—	250	°C
Time (tp-10)		10	s
Ramp up		3	°C/s
Peak temperature (Tp)	240	260 max	°C
Time to peak	30	300	s
Ramp down (peak to TL)	-4	-6	°C/s

Figure 28. Solder profile

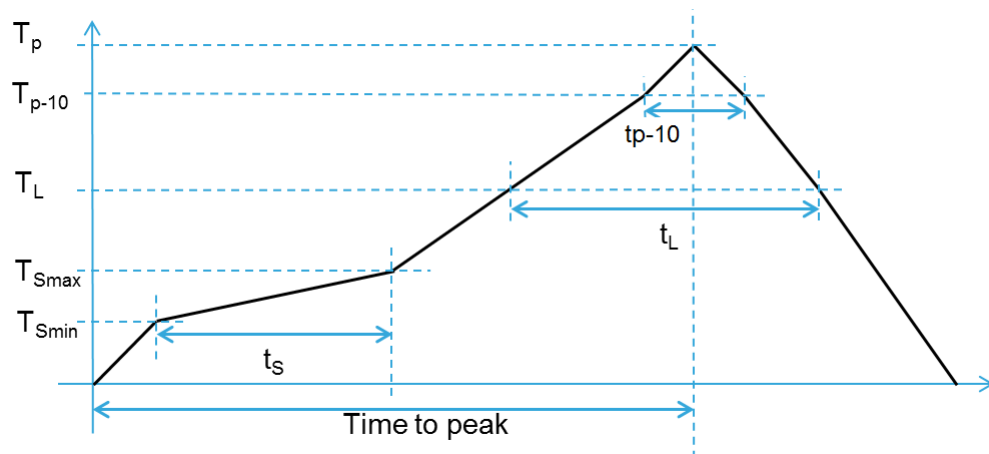

Note: The component should be limited to a maximum of three passes through this solder profile.

Note: As the VL53L0X package is not sealed, only a dry reflow process should be used (such as convection reflow). Vapor phase reflow is not suitable for this type of optical component.

Note: The VL53L0X is an optical component and should be treated carefully. This typically includes using a ‘no wash’ assembly process.

9.5 Handling and storage precautions

9.5.1 Shock precaution

Sensor modules house numerous internal components that are susceptible to shock damage. If a unit is subject to excessive shock, it must be rejected even if no apparent damage is visible. For example, if it is dropped on the floor, or if a tray/reel of units is dropped on the floor.

9.5.2 Part handling

Handling must be done with nonmarring, ESD, safe carbon, plastic, or Teflon™ tweezers. Ranging modules are susceptible to damage or contamination. The customer is advised to use a clean assembly process after removing the tape from the parts, and until a protective cover glass is mounted.

9.5.3 Compression force

A maximum compressive load of 25 N should be applied on the module.

9.5.4 Moisture sensitivity level

Moisture sensitivity is level 3 (MSL) as described in IPC/JEDEC JSTD-020-C.

9.6 Storage temperature conditions

Table 17. Recommended storage conditions

Parameter	Min.	Typ.	Max.	Unit
Temperature (storage)	-40	—	85	°C

10 Package information

In order to meet environmental requirements, ST offers these devices in different grades of **ECOPACK** packages, depending on their level of environmental compliance. ECOPACK specifications, grade definitions and product status are available at: www.st.com. ECOPACK is an ST trademark.

11 Ordering information

Table 18. Order codes

Order codes	Package	Packing
VL53L0CXV0DH/1	Optical LGA12 with liner	Tape and reel
VL53L0CXV9DH/1	Optical LGA12 without liner	Tape and reel

Revision history

Table 19. Document revision history

Date	Version	Changes
30-May-2016	1	Initial release
09-Apr-2018	2	Updated document title Updated Features Small text changes to Description. Removed note from Section 3.6.2: Ranging phase . Added text before Figure 24. Outline drawing - option with liner (3/3) .
12-Oct-2021	3	Section 4: Control interface : Replaced “camera module” with “Time-of-Flight” sensor.
29-Nov-2022	4	Updated Figure 22. Outline drawing (1/3) , Figure 23. Outline drawing (2/3) , and Figure 24. Outline drawing - option with liner (3/3) . Added a note before Figure 24. Outline drawing - option with liner (3/3) . Updated Section 9.3.1: Tape outline drawing .
08-Dec-2022	5	Updated document title. Updated Application. Removed “new generation” from the Description.
03-Jun-2023	6	Updated Section 1: Acronyms and abbreviations . Updated Section 5.5: Digital input and output . Removed the note before Figure 24. Outline drawing - option with liner (3/3) , and updated the title of this drawing. Updated Section 8: Laser safety . Removed Figure 26: Example of marking . Updated Section 9.3: Packing . Updated Section 9.3.1: Tape outline drawing . Updated Section 11: Ordering information . Master and slave replaced by controller and target respectively

Contents

1	Acronyms and abbreviations	2
2	Overview	3
2.1	Technical specification	3
2.2	System block diagram	3
2.3	Device pinout	4
2.4	Application schematic	5
3	Functional description	6
3.1	System functional description	6
3.2	Firmware state machine description	7
3.3	Customer manufacturing calibration flow	8
3.3.1	SPAD and temperature calibration	9
3.3.2	Ranging offset calibration	9
3.3.3	Crosstalk calibration	9
3.4	Ranging operating modes	10
3.5	Ranging profiles	10
3.6	Ranging profile phases	10
3.6.1	Initialization and load calibration data phase	11
3.6.2	Ranging phase	11
3.6.3	Digital housekeeping	12
3.7	Getting the data: Interrupt or polling	12
3.8	Device programming and control	12
3.9	Power sequence	13
3.10	Ranging sequence	14
4	Control interface	15
4.1	I ² C interface - timing characteristics	17
4.2	I ² C interface - reference registers	18
5	Electrical characteristics	19
5.1	Absolute maximum ratings	19
5.2	Recommended operating conditions	19
5.3	Electrostatic discharge	19
5.4	Current consumption	20
5.5	Digital input and output	20
6	Performance	21
6.1	Measurement conditions	21

6.2	Maximum ranging distance	23
6.3	Ranging accuracy	23
6.3.1	Standard deviation	23
6.3.2	Range profile examples	24
6.3.3	Ranging offset error	24
7	Outline drawings	25
8	Laser safety	28
9	Packaging and labeling	29
9.1	Product marking	29
9.2	Inner box labeling	29
9.3	Packing	29
9.3.1	Tape outline drawing	30
9.4	Pb-free solder reflow process	31
9.5	Handling and storage precautions	32
9.5.1	Shock precaution	32
9.5.2	Part handling	32
9.5.3	Compression force	32
9.5.4	Moisture sensitivity level	32
9.6	Storage temperature conditions	32
10	Package information	33
11	Ordering information	34
	Revision history	35

IMPORTANT NOTICE – READ CAREFULLY

STMicroelectronics NV and its subsidiaries (“ST”) reserve the right to make changes, corrections, enhancements, modifications, and improvements to ST products and/or to this document at any time without notice. Purchasers should obtain the latest relevant information on ST products before placing orders. ST products are sold pursuant to ST’s terms and conditions of sale in place at the time of order acknowledgment.

Purchasers are solely responsible for the choice, selection, and use of ST products and ST assumes no liability for application assistance or the design of purchasers’ products.

No license, express or implied, to any intellectual property right is granted by ST herein.

Resale of ST products with provisions different from the information set forth herein shall void any warranty granted by ST for such product.

ST and the ST logo are trademarks of ST. For additional information about ST trademarks, refer to www.st.com/trademarks. All other product or service names are the property of their respective owners.

Information in this document supersedes and replaces information previously supplied in any prior versions of this document.

© 2024 STMicroelectronics – All rights reserved