



# BCV62

## PNP general-purpose double transistors

Rev. 4 — 26 July 2010

Product data sheet

## 1. Product profile

### 1.1 General description

PNP general-purpose double transistors in a small SOT143B Surface-Mounted Device (SMD) plastic package.

Table 1. Product overview

Type number	Package		NPN complement
	Nexperia	JEITA	
BCV62	SOT143B	-	BCV61
BCV62A			BCV61A
BCV62B			BCV61B
BCV62C			BCV61C

### 1.2 Features and benefits

- Low current (max. 100 mA)
- Low voltage (max. 30 V)
- Matched pairs
- AEC-Q101 qualified
- Small SMD plastic package

### 1.3 Applications

- Applications with working point independent of temperature
- Current mirrors

### 1.4 Quick reference data

Table 2. Quick reference data

Symbol	Parameter	Conditions	Min	Typ	Max	Unit
<b>Per transistor</b>						
$V_{CE0}$	collector-emitter voltage	open base	-	-	-30	V
$I_C$	collector current		-	-	-100	mA
<b>Transistor TR1</b>						
$h_{FE}$	DC current gain	$V_{CE} = -5\text{ V}; I_C = -100\ \mu\text{A}$	100	-	-	
		$V_{CE} = -5\text{ V}; I_C = -2\text{ mA}$	100	-	800	

nexperia

Table 2. Quick reference data ...continued

Symbol	Parameter	Conditions	Min	Typ	Max	Unit
<b>Transistor TR2</b>						
$h_{FE}$	DC current gain	$V_{CE} = -5\text{ V}; I_C = -2\text{ mA}$				
	BCV62		100	-	800	
	BCV62A		100	-	250	
	BCV62B		220	-	475	
	BCV62C		420	-	800	

## 2. Pinning information

Table 3. Pinning

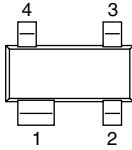
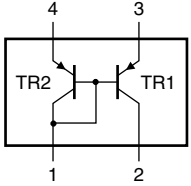
Pin	Description	Simplified outline	Graphic symbol
1	collector TR2; base TR1 and TR2		
2	collector TR1		
3	emitter TR1		
4	emitter TR2		

006aaa843

## 3. Ordering information

Table 4. Ordering information

Type number	Package		
	Name	Description	Version
BCV62	-	plastic surface-mounted package; 4 leads	SOT143B
BCV62A			
BCV62B			
BCV62C			

## 4. Marking

Table 5. Marking codes

Type number	Marking code <sup>[1]</sup>
BCV62	3M*
BCV62A	3J*
BCV62B	3K*
BCV62C	3L*

- [1] \* = -: made in Hong Kong  
 \* = p: made in Hong Kong  
 \* = t: made in Malaysia  
 \* = W: made in China

## 5. Limiting values

**Table 6. Limiting values**

In accordance with the Absolute Maximum Rating System (IEC 60134).

Symbol	Parameter	Conditions	Min	Max	Unit
<b>Per transistor</b>					
$V_{CBO}$	collector-base voltage	open emitter	-	-30	V
$V_{CEO}$	collector-emitter voltage	open base	-	-30	V
$V_{EBS}$	emitter-base voltage	$V_{CE} = 0$ V	-	-6	V
$I_C$	collector current		-	-100	mA
$I_{CM}$	peak collector current		-	-200	mA
$I_{BM}$	peak base current		-	-200	mA
<b>Per device</b>					
$P_{tot}$	total power dissipation	$T_{amb} \leq 25$ °C	[1]	250	mW
$T_j$	junction temperature		-	150	°C
$T_{amb}$	ambient temperature		-65	+150	°C
$T_{stg}$	storage temperature		-65	+150	°C

[1] Device mounted on an FR4 Printed-Circuit Board (PCB).

## 6. Thermal characteristics

**Table 7. Thermal characteristics**

Symbol	Parameter	Conditions	Min	Typ	Max	Unit
$R_{th(j-a)}$	thermal resistance from junction to ambient	in free air	[1]	-	500	K/W

[1] Device mounted on an FR4 PCB.

## 7. Characteristics

**Table 8. Characteristics**

$T_j = 25$  °C unless otherwise specified.

Symbol	Parameter	Conditions	Min	Typ	Max	Unit
<b>Transistor TR1</b>						
$I_{CBO}$	collector-base cut-off current	$V_{CB} = -30$ V; $I_E = 0$ A	-	-	-15	nA
		$V_{CB} = -30$ V; $I_E = 0$ A; $T_j = 150$ °C	-	-	-5	μA
$I_{EBO}$	emitter-base cut-off current	$V_{EB} = -5$ V; $I_C = 0$ A	-	-	-100	nA
$h_{FE}$	DC current gain	$V_{CE} = -5$ V; $I_C = -100$ μA	100	-	-	
		$V_{CE} = -5$ V; $I_C = -2$ mA	100	-	800	
$V_{CEsat}$	collector-emitter saturation voltage	$I_C = -10$ mA; $I_B = -0.5$ mA	-	-75	-300	mV
		$I_C = -100$ mA; $I_B = -5$ mA	-	-250	-650	mV

**Table 8. Characteristics ...continued**  
 $T_j = 25\text{ °C}$  unless otherwise specified.

Symbol	Parameter	Conditions	Min	Typ	Max	Unit	
$V_{BEsat}$	base-emitter saturation voltage	$I_C = -10\text{ mA};$ $I_B = -0.5\text{ mA}$	[1]	-	-700	-	mV
		$I_C = -100\text{ mA};$ $I_B = -5\text{ mA}$	[1]	-	-850	-	mV
$V_{BE}$	base-emitter voltage	$I_C = -2\text{ mA}; V_{CE} = -5\text{ V}$	[2]	-600	-650	-750	mV
		$I_C = -10\text{ mA}; V_{CE} = -5\text{ V}$	[2]	-	-	-820	mV
$f_T$	transition frequency	$V_{CE} = -5\text{ V};$ $I_C = -10\text{ mA};$ $f = 100\text{ MHz}$		100	-	-	MHz
$C_c$	collector capacitance	$V_{CB} = -10\text{ V};$ $I_E = i_e = 0\text{ A}$		-	4.5	-	pF
NF	noise figure	$V_{CE} = -5\text{ V};$ $I_C = -200\text{ }\mu\text{A}; R_S = 2\text{ k}\Omega;$ $f = 1\text{ kHz}; B = 200\text{ Hz}$		-	-	10	dB
<b>Transistor TR2</b>							
$V_{EBS}$	emitter-base voltage	$V_{CB} = 0\text{ V}; I_E = -250\text{ mA}$		-	-	-1.5	V
		$V_{CB} = 0\text{ V}; I_E = -10\text{ }\mu\text{A}$		-400	-	-	mV
$h_{FE}$	DC current gain	$V_{CE} = -5\text{ V}; I_C = -2\text{ mA}$					
		BCV62		100	-	800	
		BCV62A		100	-	250	
		BCV62B		220	-	475	
	BCV62C		420	-	800		
<b>Transistors TR1 and TR2</b>							
$I_{C1}/I_{E2}$	current matching	$I_{E2} = -0.5\text{ mA};$ $V_{CE1} = -5\text{ V};$					
		$T_{amb} \leq 25\text{ °C}$		0.7	-	1.3	
		$T_{amb} \leq 150\text{ °C}$		0.7	-	1.3	
$I_{E2}$	emitter current 2	$V_{CE1} = -5\text{ V}$	[3]	-	-	-5	mA

[1]  $V_{BEsat}$  decreases by about 1.7 mV/K with increasing temperature.

[2]  $V_{BE}$  decreases by about 2 mV/K with increasing temperature.

[3] Device, without emitter resistors, mounted on an FR4 PCB.

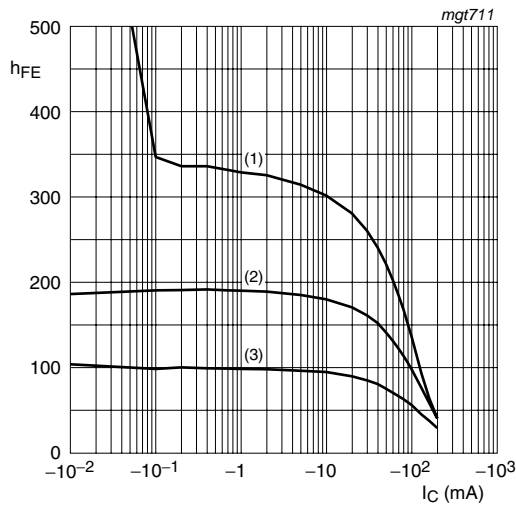

$V_{CE} = -5\text{ V}$   
 (1)  $T_{amb} = 150\text{ °C}$   
 (2)  $T_{amb} = 25\text{ °C}$   
 (3)  $T_{amb} = -55\text{ °C}$

**Fig 1. BCV62A: DC current gain as a function of collector current; typical values**

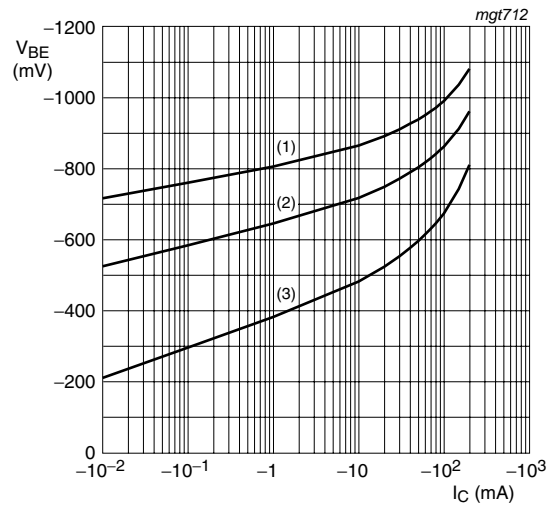

$V_{CE} = -5\text{ V}$   
 (1)  $T_{amb} = -55\text{ °C}$   
 (2)  $T_{amb} = 25\text{ °C}$   
 (3)  $T_{amb} = 150\text{ °C}$

**Fig 2. BCV62A: Base-emitter voltage as a function of collector current; typical values**

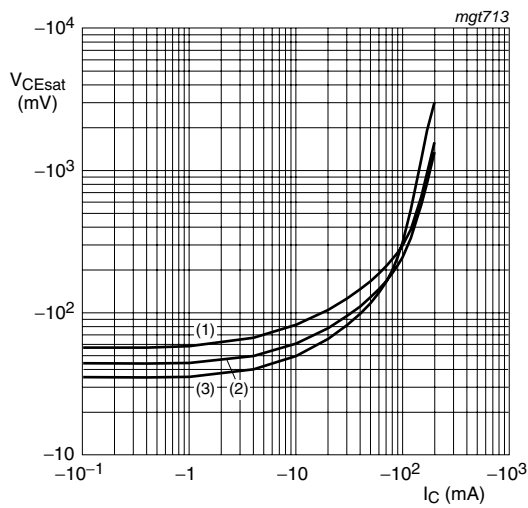

$I_C/I_B = 20$   
 (1)  $T_{amb} = 150\text{ °C}$   
 (2)  $T_{amb} = 25\text{ °C}$   
 (3)  $T_{amb} = -55\text{ °C}$

**Fig 3. BCV62A: Collector-emitter saturation voltage as a function of collector current; typical values**

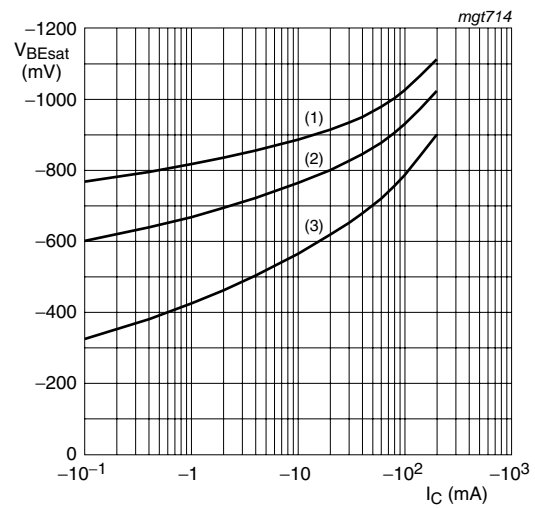

$I_C/I_B = 20$   
 (1)  $T_{amb} = -55\text{ °C}$   
 (2)  $T_{amb} = 25\text{ °C}$   
 (3)  $T_{amb} = 150\text{ °C}$

**Fig 4. BCV62A: Base-emitter saturation voltage as a function of collector current; typical values**

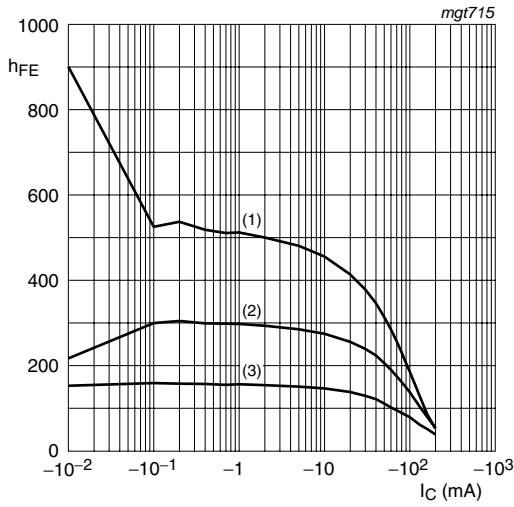

$V_{CE} = -5\text{ V}$   
 (1)  $T_{amb} = 150\text{ °C}$   
 (2)  $T_{amb} = 25\text{ °C}$   
 (3)  $T_{amb} = -55\text{ °C}$

**Fig 5. BCV62B: DC current gain as a function of collector current; typical values**

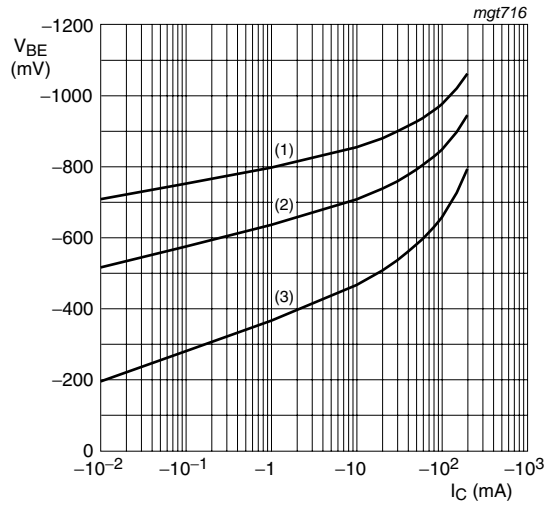

$V_{CE} = -5\text{ V}$   
 (1)  $T_{amb} = -55\text{ °C}$   
 (2)  $T_{amb} = 25\text{ °C}$   
 (3)  $T_{amb} = 150\text{ °C}$

**Fig 6. BCV62B: Base-emitter voltage as a function of collector current; typical values**

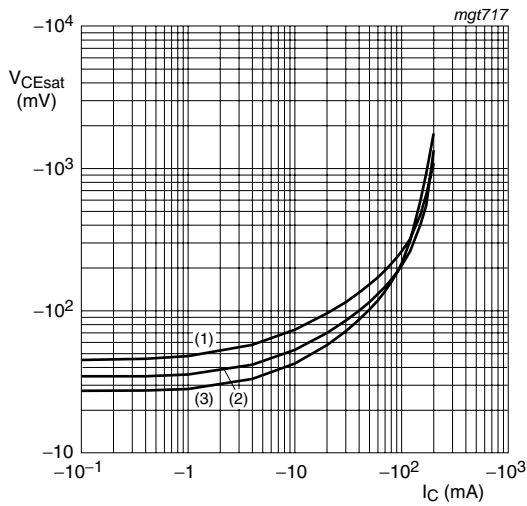

$I_C/I_B = 20$   
 (1)  $T_{amb} = 150\text{ °C}$   
 (2)  $T_{amb} = 25\text{ °C}$   
 (3)  $T_{amb} = -55\text{ °C}$

**Fig 7. BCV62B: Collector-emitter saturation voltage as a function of collector current; typical values**

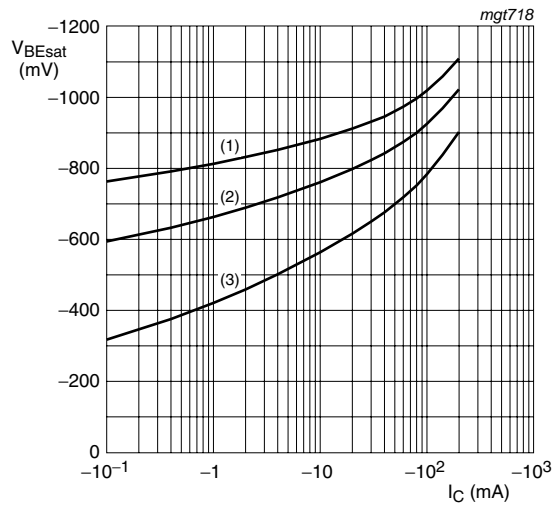

$I_C/I_B = 20$   
 (1)  $T_{amb} = -55\text{ °C}$   
 (2)  $T_{amb} = 25\text{ °C}$   
 (3)  $T_{amb} = 150\text{ °C}$

**Fig 8. BCV62B: Base-emitter saturation voltage as a function of collector current; typical values**

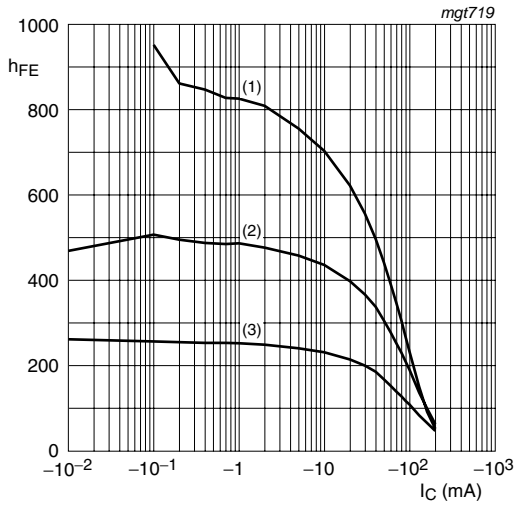

$V_{CE} = -5\text{ V}$   
 (1)  $T_{amb} = 150\text{ °C}$   
 (2)  $T_{amb} = 25\text{ °C}$   
 (3)  $T_{amb} = -55\text{ °C}$

**Fig 9. BCV62C: DC current gain as a function of collector current; typical values**

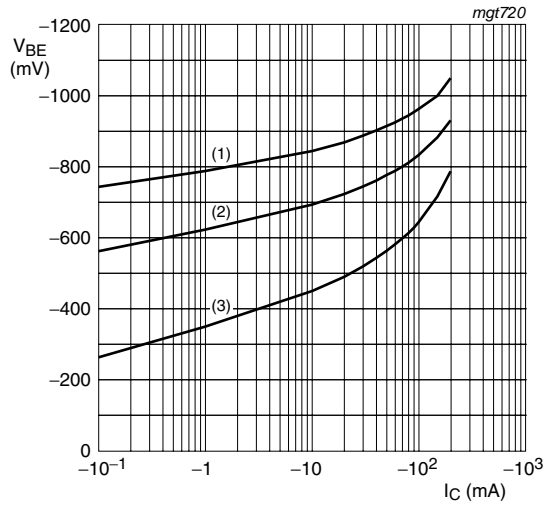

$V_{CE} = -5\text{ V}$   
 (1)  $T_{amb} = -55\text{ °C}$   
 (2)  $T_{amb} = 25\text{ °C}$   
 (3)  $T_{amb} = 150\text{ °C}$

**Fig 10. BCV62C: Base-emitter voltage as a function of collector current; typical values**

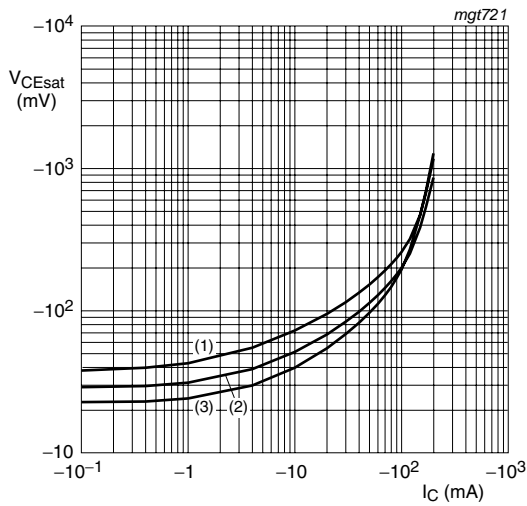

$I_C/I_B = 20$   
 (1)  $T_{amb} = 150\text{ °C}$   
 (2)  $T_{amb} = 25\text{ °C}$   
 (3)  $T_{amb} = -55\text{ °C}$

**Fig 11. BCV62C: Collector-emitter saturation voltage as a function of collector current; typical values**

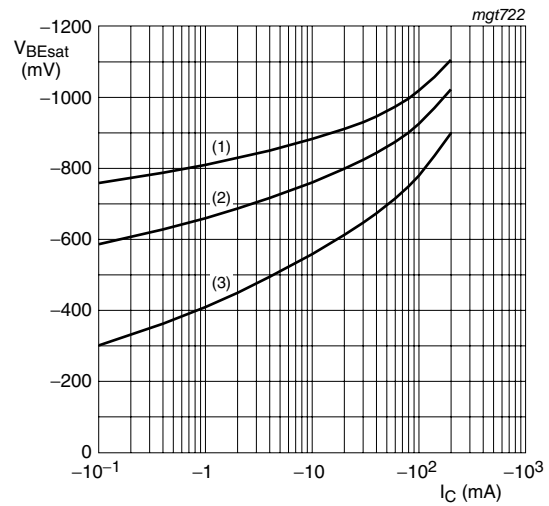

$I_C/I_B = 20$   
 (1)  $T_{amb} = -55\text{ °C}$   
 (2)  $T_{amb} = 25\text{ °C}$   
 (3)  $T_{amb} = 150\text{ °C}$

**Fig 12. BCV62C: Base-emitter saturation voltage as a function of collector current; typical values**

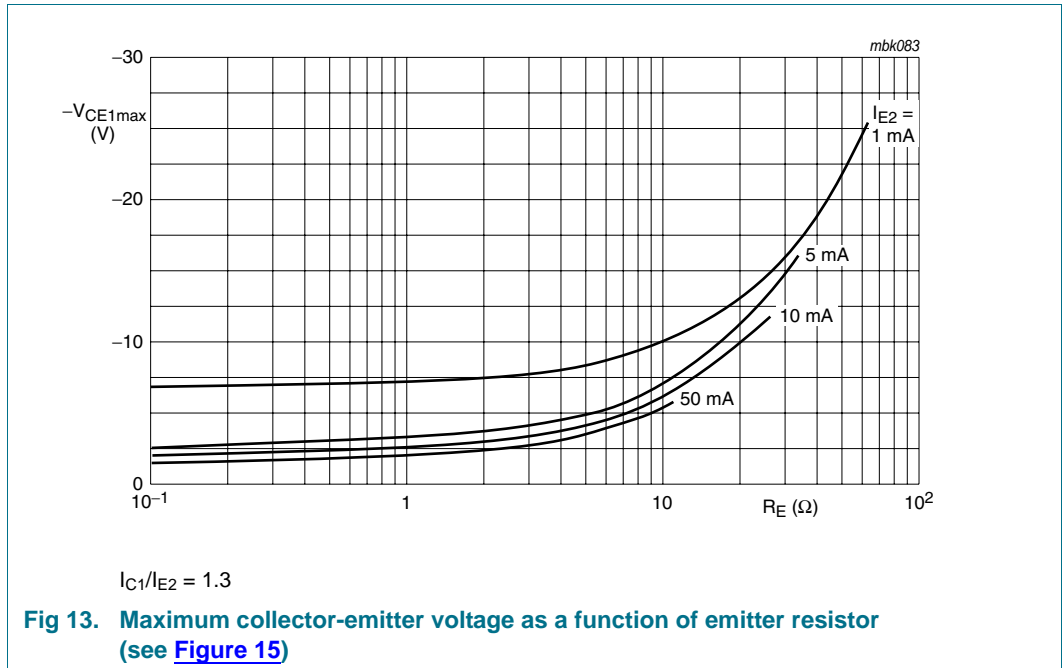

## 8. Test information

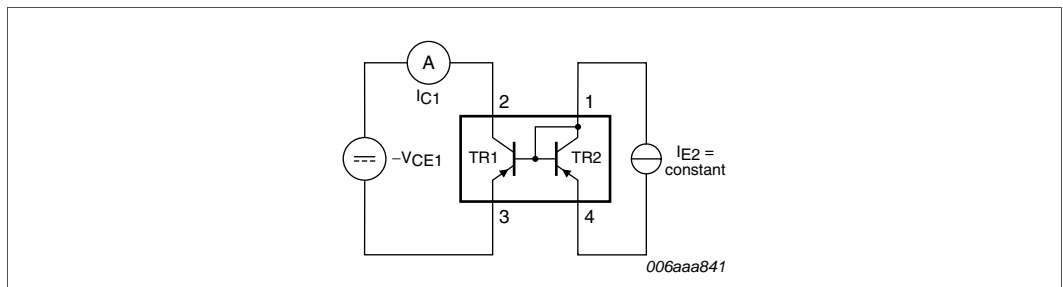

**Fig 14. Test circuit current matching**

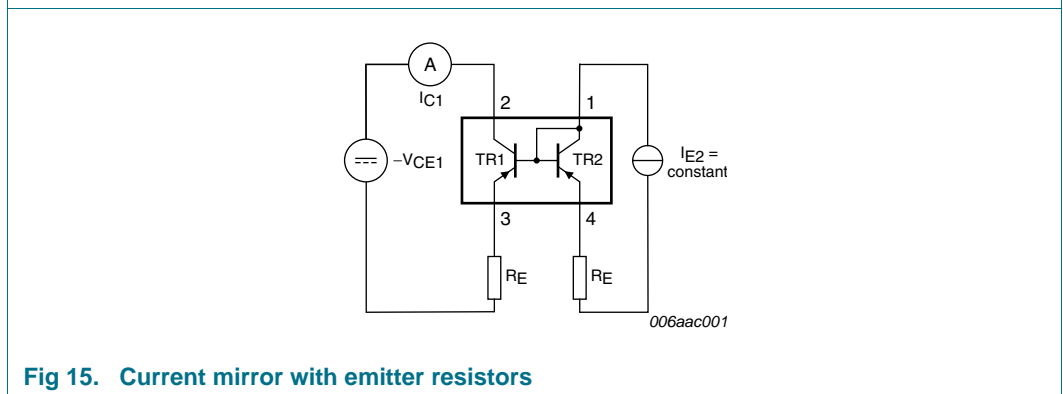

**Fig 15. Current mirror with emitter resistors**



## 8.1 Quality information

This product has been qualified in accordance with the Automotive Electronics Council (AEC) standard Q101 - *Stress test qualification for discrete semiconductors*, and is suitable for use in automotive applications.

## 9. Package outline

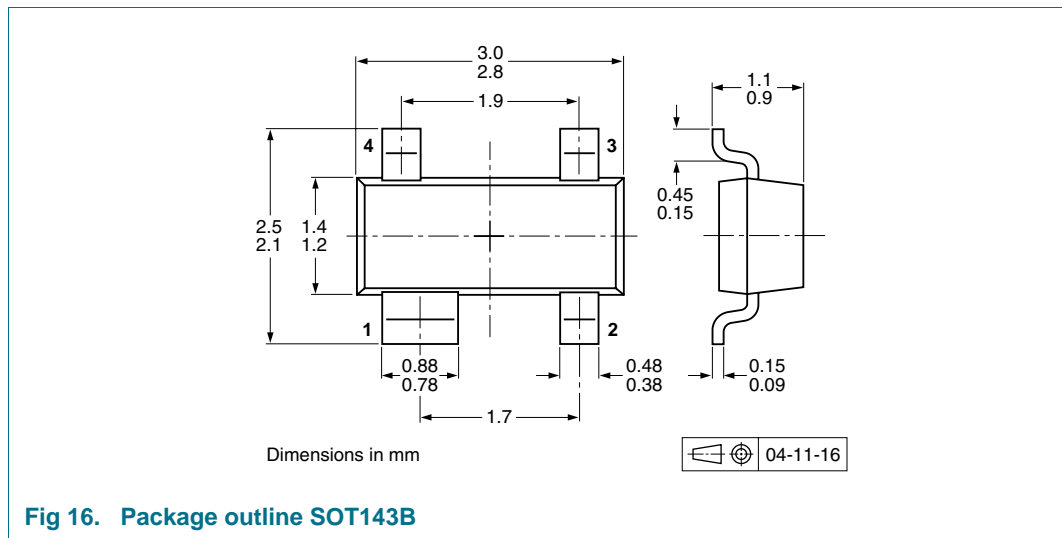

Fig 16. Package outline SOT143B

## 10. Packing information

**Table 9. Packing methods**

The indicated -xxx are the last three digits of the 12NC ordering code.<sup>[1]</sup>

Type number	Package	Description	Packing quantity	
			3000	10000
BCV62	SOT143B	4 mm pitch, 8 mm tape and reel	-215	-235
BCV62A				
BCV62B				
BCV62C				

[1] For further information and the availability of packing methods, see [Section 14](#).

11. Soldering

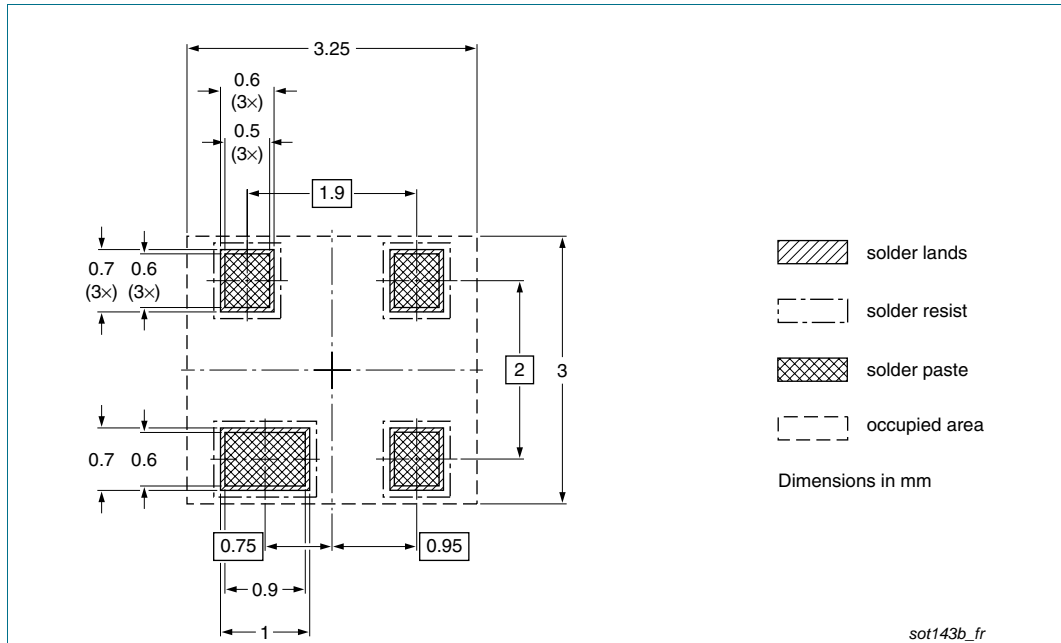

Fig 17. Reflow soldering footprint SOT143B

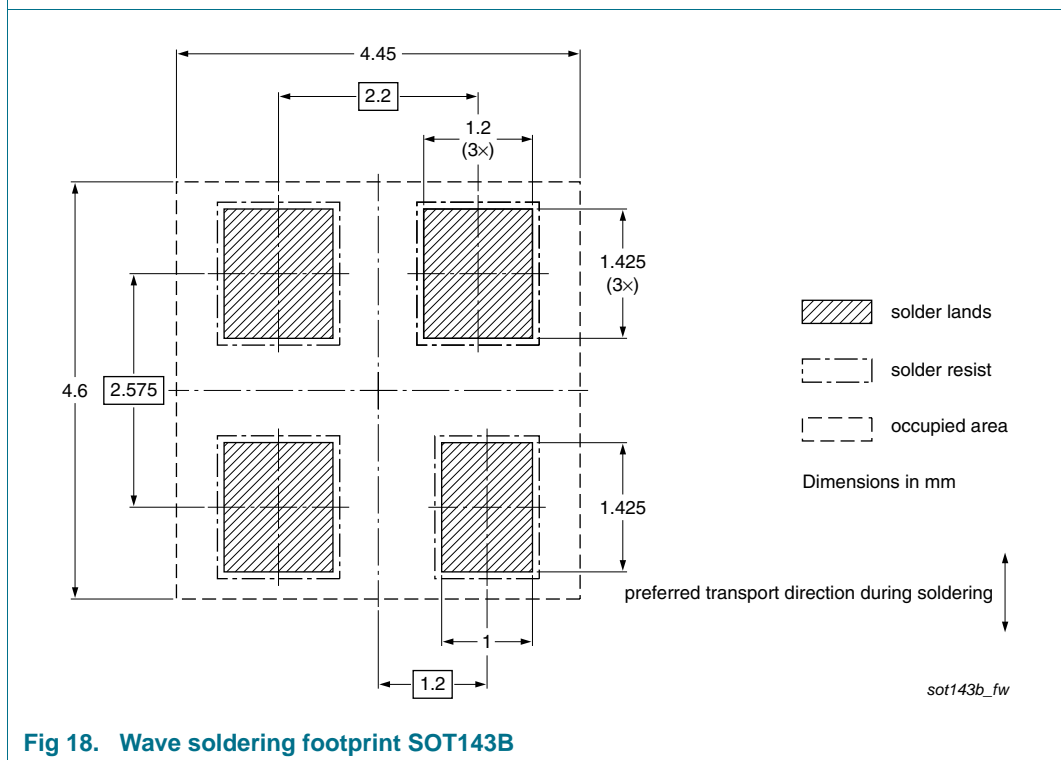

Fig 18. Wave soldering footprint SOT143B

## 12. Revision history

Table 10. Revision history

Document ID	Release date	Data sheet status	Change notice	Supersedes
BCV62 v.4	20100726	Product data sheet	-	BCV62_3
Modifications:	<ul style="list-style-type: none"> <li>• The format of this data sheet has been redesigned to comply with the new identity guidelines of NXP Semiconductors.</li> <li>• Legal texts have been adapted to the new company name where appropriate.</li> <li>• <a href="#">Section 1 “Product profile”</a>: amended</li> <li>• <a href="#">Section 3 “Ordering information”</a>: added</li> <li>• <a href="#">Section 4 “Marking”</a>: updated</li> <li>• <a href="#">Figure 1, 2, 3, 4, 5, 6, 7, 8, 9, 10, 11</a> and <a href="#">12</a>: added</li> <li>• <a href="#">Section 8 “Test information”</a>: added</li> <li>• <a href="#">Figure 16</a>: superseded by minimized package outline drawing</li> <li>• <a href="#">Section 10 “Packing information”</a>: added</li> <li>• <a href="#">Section 11 “Soldering”</a>: added</li> <li>• <a href="#">Section 13 “Legal information”</a>: updated</li> </ul>			
BCV62_3	19990408	Product specification	-	BCV62_CNV_2
BCV62_CNV_2	19970618	Product specification	-	-

## 13. Legal information

### 13.1 Data sheet status

Document status <sup>[1][2]</sup>	Product status <sup>[3]</sup>	Definition
Objective [short] data sheet	Development	This document contains data from the objective specification for product development.
Preliminary [short] data sheet	Qualification	This document contains data from the preliminary specification.
Product [short] data sheet	Production	This document contains the product specification.

[1] Please consult the most recently issued document before initiating or completing a design.

[2] The term 'short data sheet' is explained in section "Definitions".

[3] The product status of device(s) described in this document may have changed since this document was published and may differ in case of multiple devices. The latest product status information is available on the Internet at URL <http://www.nexperia.com>.

### 13.2 Definitions

**Draft** — The document is a draft version only. The content is still under internal review and subject to formal approval, which may result in modifications or additions. Nexperia does not give any representations or warranties as to the accuracy or completeness of information included herein and shall have no liability for the consequences of use of such information.

**Short data sheet** — A short data sheet is an extract from a full data sheet with the same product type number(s) and title. A short data sheet is intended for quick reference only and should not be relied upon to contain detailed and full information. For detailed and full information see the relevant full data sheet, which is available on request via the local Nexperia sales office. In case of any inconsistency or conflict with the short data sheet, the full data sheet shall prevail.

**Product specification** — The information and data provided in a Product data sheet shall define the specification of the product as agreed between Nexperia and its customer, unless Nexperia and customer have explicitly agreed otherwise in writing. In no event however, shall an agreement be valid in which the Nexperia product is deemed to offer functions and qualities beyond those described in the Product data sheet.

### 13.3 Disclaimers

**Limited warranty and liability** — Information in this document is believed to be accurate and reliable. However, Nexperia does not give any representations or warranties, expressed or implied, as to the accuracy or completeness of such information and shall have no liability for the consequences of use of such information.

In no event shall Nexperia be liable for any indirect, incidental, punitive, special or consequential damages (including - without limitation - lost profits, lost savings, business interruption, costs related to the removal or replacement of any products or rework charges) whether or not such damages are based on tort (including negligence), warranty, breach of contract or any other legal theory.

Notwithstanding any damages that customer might incur for any reason whatsoever, Nexperia's aggregate and cumulative liability towards customer for the products described herein shall be limited in accordance with the *Terms and conditions of commercial sale* of Nexperia.

**Right to make changes** — Nexperia reserves the right to make changes to information published in this document, including without limitation specifications and product descriptions, at any time and without notice. This document supersedes and replaces all information supplied prior to the publication hereof.

**Suitability for use** — Nexperia products are not designed, authorized or warranted to be suitable for use in life support, life-critical or safety-critical systems or equipment, nor in applications where failure or

malfunction of a Nexperia product can reasonably be expected to result in personal injury, death or severe property or environmental damage. Nexperia accepts no liability for inclusion and/or use of Nexperia products in such equipment or applications and therefore such inclusion and/or use is at the customer's own risk.

**Applications** — Applications that are described herein for any of these products are for illustrative purposes only. Nexperia makes no representation or warranty that such applications will be suitable for the specified use without further testing or modification.

Customers are responsible for the design and operation of their applications and products using Nexperia products, and Nexperia accepts no liability for any assistance with applications or customer product design. It is customer's sole responsibility to determine whether the Nexperia product is suitable and fit for the customer's applications and products planned, as well as for the planned application and use of customer's third party customer(s). Customers should provide appropriate design and operating safeguards to minimize the risks associated with their applications and products.

Nexperia does not accept any liability related to any default, damage, costs or problem which is based on any weakness or default in the customer's applications or products, or the application or use by customer's third party customer(s). Customer is responsible for doing all necessary testing for the customer's applications and products using Nexperia products in order to avoid a default of the applications and the products or of the application or use by customer's third party customer(s). Nexperia does not accept any liability in this respect.

**Limiting values** — Stress above one or more limiting values (as defined in the Absolute Maximum Ratings System of IEC 60134) will cause permanent damage to the device. Limiting values are stress ratings only and (proper) operation of the device at these or any other conditions above those given in the Recommended operating conditions section (if present) or the Characteristics sections of this document is not warranted. Constant or repeated exposure to limiting values will permanently and irreversibly affect the quality and reliability of the device.

**Terms and conditions of commercial sale** — Nexperia products are sold subject to the general terms and conditions of commercial sale, as published at <http://www.nexperia.com/profile/terms>, unless otherwise agreed in a valid written individual agreement. In case an individual agreement is concluded only the terms and conditions of the respective agreement shall apply. Nexperia hereby expressly objects to applying the customer's general terms and conditions with regard to the purchase of Nexperia products by customer.

**No offer to sell or license** — Nothing in this document may be interpreted or construed as an offer to sell products that is open for acceptance or the grant, conveyance or implication of any license under any copyrights, patents or other industrial or intellectual property rights.

**Export control** — This document as well as the item(s) described herein may be subject to export control regulations. Export might require a prior authorization from national authorities.

**Quick reference data** — The Quick reference data is an extract of the product data given in the Limiting values and Characteristics sections of this document, and as such is not complete, exhaustive or legally binding.

## 13.4 Trademarks

Notice: All referenced brands, product names, service names and trademarks are the property of their respective owners.

## 14. Contact information

---

For more information, please visit: <http://www.nexperia.com>

For sales office addresses, please send an email to: [salesaddresses@nexperia.com](mailto:salesaddresses@nexperia.com)

## 15. Contents

---

<b>1</b>	<b>Product profile</b> . . . . .	<b>1</b>
1.1	General description . . . . .	1
1.2	Features and benefits . . . . .	1
1.3	Applications . . . . .	1
1.4	Quick reference data . . . . .	1
<b>2</b>	<b>Pinning information</b> . . . . .	<b>2</b>
<b>3</b>	<b>Ordering information</b> . . . . .	<b>2</b>
<b>4</b>	<b>Marking</b> . . . . .	<b>2</b>
<b>5</b>	<b>Limiting values</b> . . . . .	<b>3</b>
<b>6</b>	<b>Thermal characteristics</b> . . . . .	<b>3</b>
<b>7</b>	<b>Characteristics</b> . . . . .	<b>3</b>
<b>8</b>	<b>Test information</b> . . . . .	<b>8</b>
8.1	Quality information . . . . .	9
<b>9</b>	<b>Package outline</b> . . . . .	<b>9</b>
<b>10</b>	<b>Packing information</b> . . . . .	<b>9</b>
<b>11</b>	<b>Soldering</b> . . . . .	<b>10</b>
<b>12</b>	<b>Revision history</b> . . . . .	<b>11</b>
<b>13</b>	<b>Legal information</b> . . . . .	<b>12</b>
13.1	Data sheet status . . . . .	12
13.2	Definitions . . . . .	12
13.3	Disclaimers . . . . .	12
13.4	Trademarks . . . . .	13
<b>14</b>	<b>Contact information</b> . . . . .	<b>13</b>
<b>15</b>	<b>Contents</b> . . . . .	<b>14</b>