

Right Angle Surface Mount Connectors feature gold alloy TwistPin contacts. These nanominiature connectors offer premium performance and reliability for demanding applications.

Choose Aluminum, Titanium or Stainless Steel Shells in eleven layouts from 9 to 85 contacts. Complies to the requirements of MIL-DTL-32139.

Pre-Tinned PC Tails are coated with Sn63Pb37 or Sn60Pb40 tin-lead for excellent solderability.

How to Order										
Sample Part Number	<table border="1"> <tr> <td>891-012</td> <td>-25P</td> <td>A2</td> <td>-BRS</td> <td>T</td> </tr> </table>					891-012	-25P	A2	-BRS	T
891-012	-25P	A2	-BRS	T						
Series	891-012 Plug, Right Angle Surface Mount Connector 891-013 Receptacle, Right Angle Surface Mount Connector									
Insert Arrangement/Contact Type	Pins (891-012 Plugs) 9P, 15P, 21P, 25P, 31P, 37P, 41P, 51P, 65P, 69P, 85P Socket (891-013 Receptacles) 9S, 15S, 21S, 25S, 31S, 37S, 41S, 51S, 65S, 69S, 85S									
Shell Material and Finish	<table border="1"> <tr> <td>A1 - Aluminum Shell, Cadmium Plating</td> <td>T - Titanium Shell, Unplated</td> </tr> <tr> <td>A2 - Aluminum Shell, Electroless Nickel Plating</td> <td>S - Stainless Steel Shell, Passivated</td> </tr> </table>					A1 - Aluminum Shell, Cadmium Plating	T - Titanium Shell, Unplated	A2 - Aluminum Shell, Electroless Nickel Plating	S - Stainless Steel Shell, Passivated	
A1 - Aluminum Shell, Cadmium Plating	T - Titanium Shell, Unplated									
A2 - Aluminum Shell, Electroless Nickel Plating	S - Stainless Steel Shell, Passivated									
Termination Type	BRS - Board Right Angle Surface Mount									
Hardware	T - Female Thread									

D

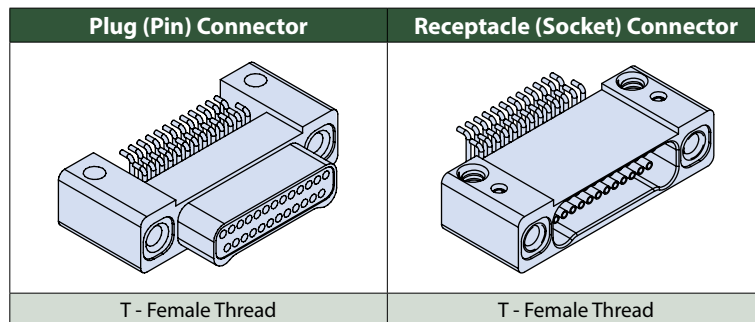

NOTES

- Material and Finish:
 - Shell: see part number break down
 - Insulator: LCP/N/A
 - Contacts: gold alloy per ASTM B477 and ASTM B541
 - Pre-tinned PC tails: coated with Sn63Pb37 or Sn60Pb40 tin-lead
 - Hardware: passivated stainless steel
- Inspect and test IAW MIL-DTL-32139
- Interface dimensions per MIL-DTL-32139/3 and /4

DETAIL A

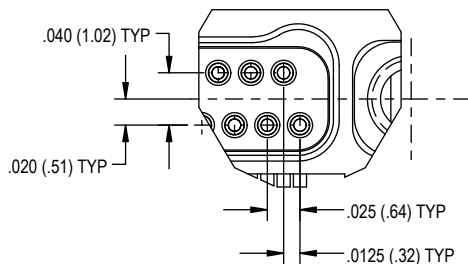

DETAIL B

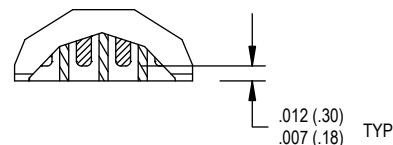

Dimensions

891-012 Plug (Pin) Connectors

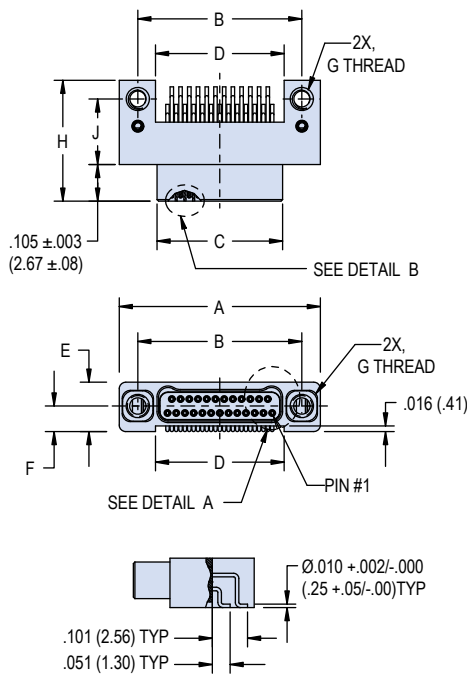

891-013 Receptacle (Socket) Connectors

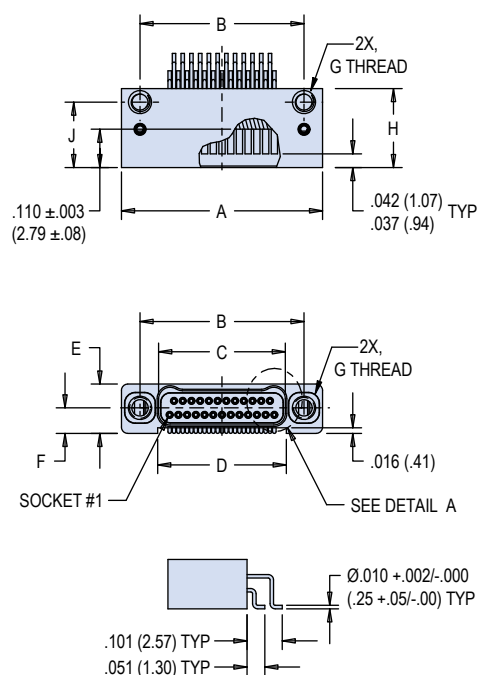

Layout	A		B BSC.		C BSC.		D		E		F BSC.		G Thread	H		J	
	In.	mm.	In.	mm.	In.	mm.	In.	mm.	In.	mm.	In.	mm.		In.	mm.	In.	mm.
9P	.375	9.52	.270	6.86	.160	4.06	.170	4.32	.140	3.56	.0725	1.84	#0-80 UNF	.345	8.76	.187	4.75
9S	.375	9.52	.270	6.86	.163	4.14	.170	4.32	.140	3.56	.0725	1.84	#0-80 UNF	.225	5.71	.187	4.75
15P	.450	11.43	.345	8.76	.235	5.97	.245	6.22	.140	3.56	.0725	1.84	#0-80 UNF	.345	8.76	.187	4.75
15S	.450	11.43	.345	8.76	.238	6.04	.245	6.22	.140	3.56	.0725	1.84	#0-80 UNF	.225	5.71	.187	4.75
21P	.525	13.33	.420	10.67	.310	7.87	.320	8.13	.140	3.56	.0725	1.84	#0-80 UNF	.345	8.76	.187	4.75
21S	.525	13.33	.420	10.67	.313	7.95	.320	8.13	.140	3.56	.0725	1.84	#0-80 UNF	.225	5.71	.187	4.75
25P	.575	14.60	.470	11.94	.360	9.14	.370	9.40	.140	3.56	.0725	1.84	#0-80 UNF	.345	8.76	.187	4.75
25S	.575	14.60	.470	11.94	.363	9.22	.370	9.40	.140	3.56	.0725	1.84	#0-80 UNF	.225	5.71	.187	4.75
31P	.650	16.51	.545	13.84	.435	11.05	.445	11.30	.140	3.56	.0725	1.84	#0-80 UNF	.345	8.76	.187	4.75
31S	.650	16.51	.545	13.84	.438	11.12	.445	11.30	.140	3.56	.0725	1.84	#0-80 UNF	.225	5.71	.187	4.75
37P	.725	18.41	.620	15.75	.510	12.95	.520	13.21	.140	3.56	.0725	1.84	#0-80 UNF	.345	8.76	.187	4.75
37S	.725	18.41	.620	15.75	.513	13.03	.520	13.21	.140	3.56	.0725	1.84	#0-80 UNF	.225	5.71	.187	4.75
41P	.775	19.69	.670	17.02	.560	14.23	.570	14.48	.140	3.56	.0725	1.84	#0-80 UNF	.345	8.76	.187	4.75
41S	.775	19.69	.670	17.02	.563	14.30	.570	14.48	.140	3.56	.0725	1.84	#0-80 UNF	.225	5.72	.187	4.75
51P	.900	22.86	.795	20.19	.685	17.40	.695	17.65	.140	3.56	.0725	1.84	#0-80 UNF	.345	8.76	.187	4.75
51S	.900	22.86	.795	20.19	.688	17.47	.695	17.65	.140	3.56	.0725	1.84	#0-80 UNF	.225	5.71	.187	4.75
65P	1.075	27.30	.970	24.64	.860	21.84	.870	22.10	.140	3.56	.0725	1.84	#0-80 UNF	.345	8.76	.187	4.75
65S	1.075	27.30	.970	24.64	.863	21.92	.870	22.10	.140	3.56	.0725	1.84	#0-80 UNF	.225	5.71	.187	4.75
69P	1.125	28.57	1.020	25.91	.910	23.11	.920	23.37	.140	3.56	.0725	1.84	#0-80 UNF	.345	8.76	.187	4.75
69S	1.125	28.57	1.020	25.91	.913	23.19	.920	23.37	.140	3.56	.0725	1.84	#0-80 UNF	.225	5.71	.187	4.75
85P	1.377	34.97	1.246	31.65	1.110	28.19	1.120	28.45	.165	4.19	.085	2.16	#2-56 UNC	.375	9.53	.205	5.34
85S	1.377	34.97	1.246	31.65	1.113	28.27	1.120	28.45	.165	4.19	.085	2.16	#2-56 UNC	.270	6.86	.210	5.21



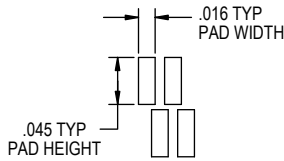

PAD FOOTPRINT DETAIL

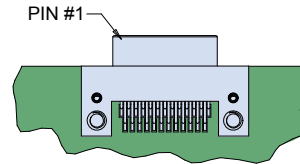

Pin #1 Position

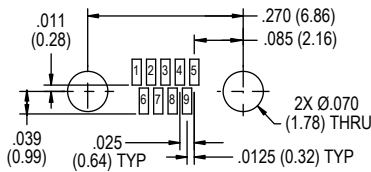

9 Contacts

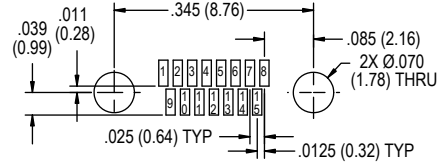

15 Contacts

D

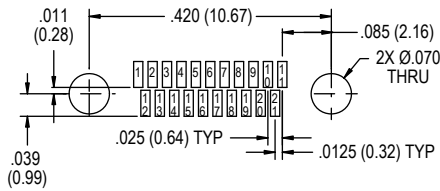

21 Contacts

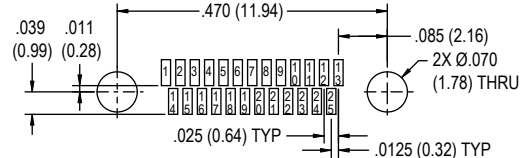

25 Contacts

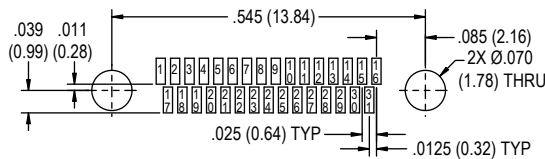

31 Contacts

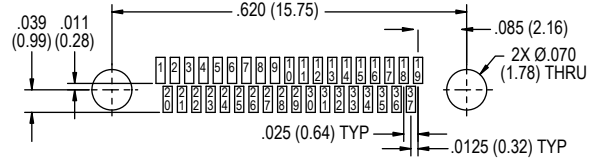

37 Contacts

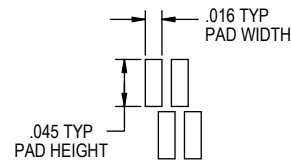

PAD FOOTPRINT DETAIL

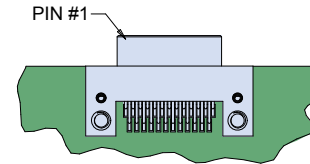

Pin #1 Position

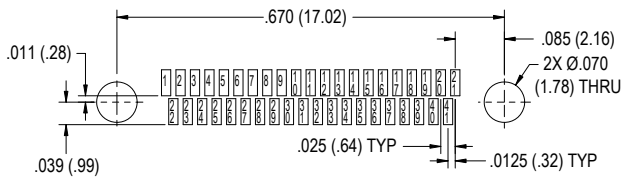

41 Contacts

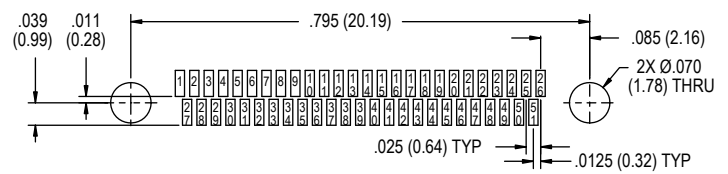

51 Contacts

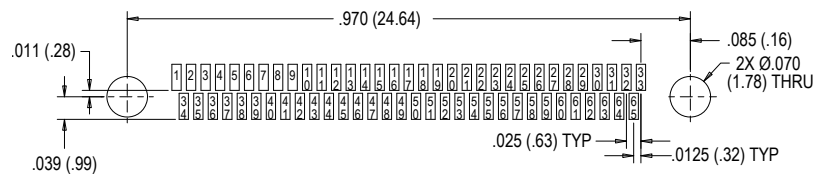

65 Contacts

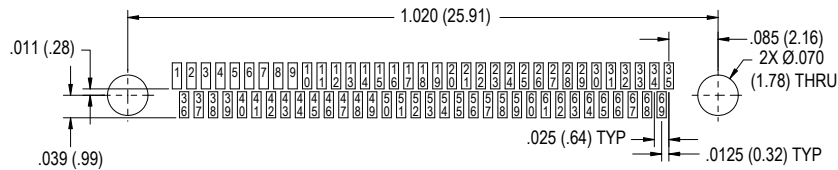

69 Contacts

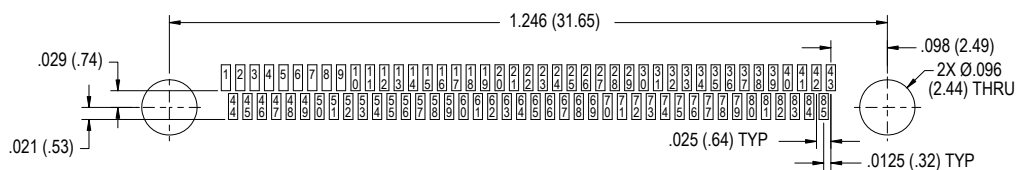

85 Contacts

D

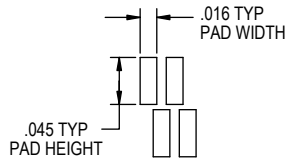

PAD FOOTPRINT DETAIL

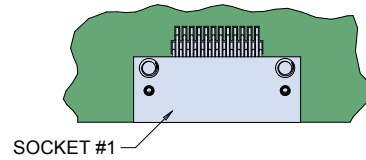

CONNECTOR ORIENTATION

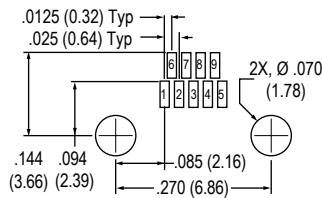

9 Contacts

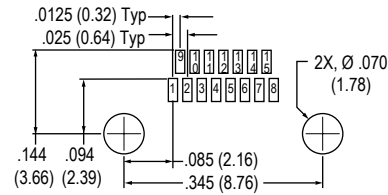

15 Contacts

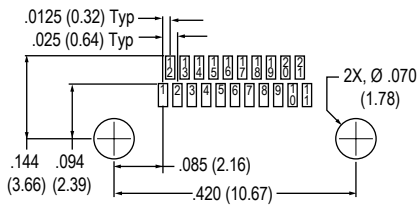

21 Contacts

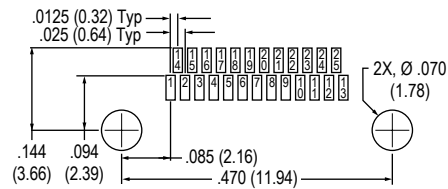

25 Contacts

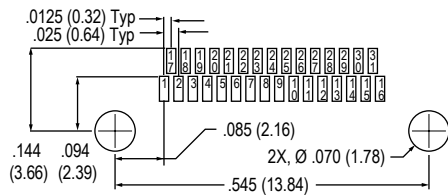

31 Contacts

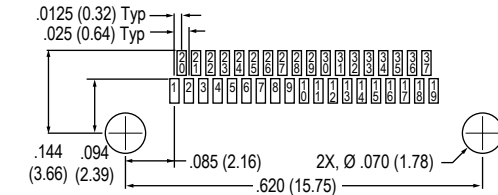

37 Contacts

D

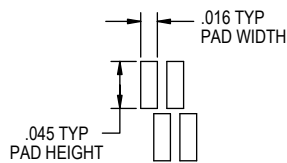

PAD FOOTPRINT DETAIL

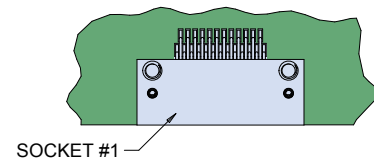

CONNECTOR ORIENTATION

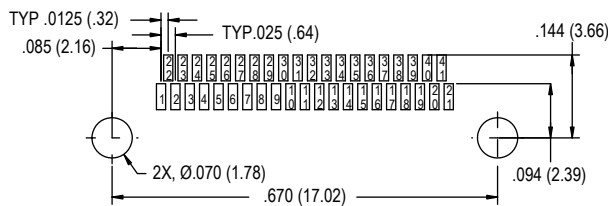

41 Contacts

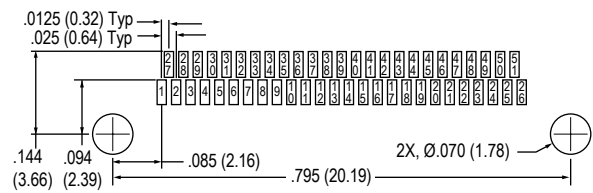

51 Contacts

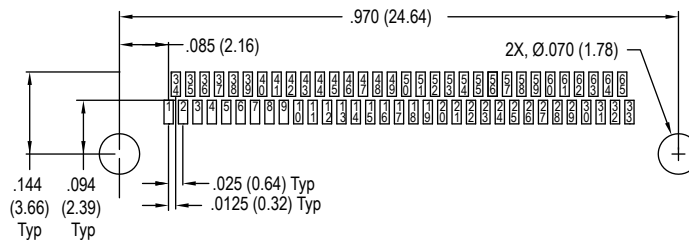

65 Contacts

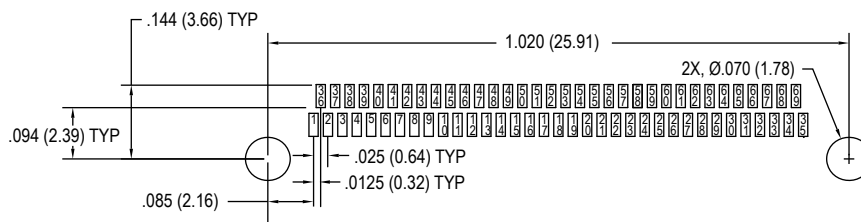

69 Contacts

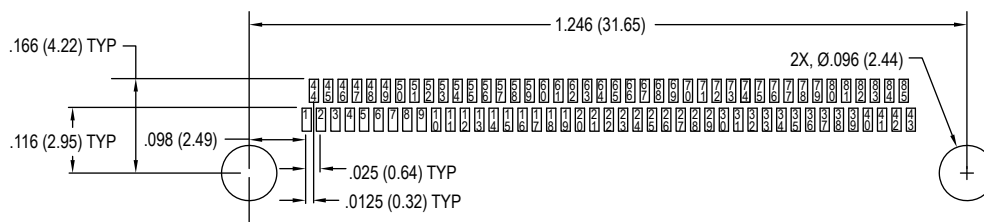

85 Contacts



Mouser Electronics

Authorized Distributor

Click to View Pricing, Inventory, Delivery & Lifecycle Information:

Glenair:

[891-013-21SA2-BRST](#) [891-013-51SA2-BRST](#) [891-012-51PA2-BRST](#) [891-013-37SA2-BRST](#) [890-013-51SS-BRST](#)
[891-0129PA2-BRST](#) [891-012-31PA1-BRST](#) [891-012-37PA2-BRST](#) [891-012-37PA1-BRST](#) [890-013-15SA2-BRST](#)
[890-0139SA2-BRST](#) [891-012-37PS-BRST](#) [891-0139SA2-BRST](#) [890-012-51PS-BRST](#) [891-013-37SS-BRST](#) [891-013-](#)
[51SS-BRST](#) [891-012-51PA1-BRST](#) [890012-15PA2-BRST](#) [891-012-51PS-BRST](#) [891-013-37ST-BRST](#) [891-012-](#)
[15PA2-BRST](#) [891-012-21PA2-BRST](#) [890-012-31PT-BRST](#) [890-0129PA2-BRST](#) [891-012-25PS-BRST](#) [891-013-](#)
[31SS-BRST](#)