

|   |   |       |
|---|---|-------|
| GlobTek, Inc.<br>www.globtek.com<br>186 Veterans Drive,<br>Northvale, NJ 07647<br>Tel. (201) 784-1000<br>Fax (201) 784-0111 | Drawing Title: GT-86181-1815 -W2, ICT/ITE Power Supply, Efficiency Level: USA DOE Level VI / Eco-design Directive 2009/125/EC, (EU) 2019/1782, Case Color/Style: GlobTek Black, Wall Plug-in, Regulated Switchmode AC-DC Power Supply AC Adaptor, Input Rating: 100-240V- , 50/60Hz, N. America NEMA 1-15 Fixed, , Output Rating: 18.00W, 15.0V@1.2A, Pin Out: Center Positive (+V), symbol compliant with IEC 60417 symbol no. 5926, Output Configuration: 1500 mm, 20/2 Cond, UL 2468, Female Barrel 5.5*2.1*11mm w/ Spring Clip & Locking Notch or Equal, Ferrite: None, GlobTek Black, GT Cord # C5034, Blades/Input Cord: (Order Separately), Approvals: |       |
|   | Model No. GT-86181-1815 -W2   |       |
|   | Part No./Ordering No. WR9HG1200CCP-F(R6B)   | Rev A |

In Addition to GlobTek Inc.'s renewed ISO9001:2015 - Quality Management System Certification, GlobTek Inc. is now certified to:

ISO13485:2016 - Medical Devices Quality Management System Certification

ISO14001:2015 - Environmental Management System Certification

ISO Certificates are available online at <https://www.globtek.com/iso-certificates/>

The acceptance of this specification and use of the product described in this document indicates the acceptance and binding of the customer to Globtek TERMS AND CONDITIONS (attached to the end of this document), which supersede all other agreements, terms, and conditions (<https://www.globtek.com/terms-and-conditions/>).

The purchaser of this product (Customer) agrees that it is their sole responsibility to determine suitability/fitness of the product described in this specification for their application and to take precautions for protection against any hazards attendant to the handling and use of the product.

Footnote:

GlobTek Inc. will not be liable for the safety and performance of these power supplies/battery packs if unauthorized access and repair occurs. End user should consult applicable UL, CSA or EN standards for proper installation instruction.

Limitation of Use:

GlobTek products are intended for use with commercial, medical, and/or industrial equipment only. GlobTek product are not authorized for use as mission critical components in life support hazardous environment, nuclear or aircraft applications without prior written approval from the CEO of GlobTek Inc.

Contents of this document are subject to change without prior notice.

### Customer Approval of Specification:

Please approve, sign and send back to GlobTek so we can complete order processing.

A delay in receipt of this form will delay delivery schedule.

|                                       |  |
|---------------------------------------|--|
| Company Name: _____                   | Customer P/N: _____                        |
| Quote Number: _____                   | Date: _____                                |
| Authorized Representative Name: _____ | Authorized Representative Signature: _____ |

|  |   |       |
|--|---|-------|
| <b>GlobTek, Inc.</b><br>www.globtek.com<br>186 Veterans Drive,<br>Northvale, NJ 07647<br>Tel. (201) 784-1000<br>Fax (201) 784-0111 | Drawing Title: GT-86181-1815 -W2, ICT/ITE Power Supply, Efficiency Level: USA DOE Level VI / Eco-design Directive 2009/125/EC, (EU) 2019/1782, Case Color/Style: GlobTek Black, Wall Plug-in, Regulated Switchmode AC-DC Power Supply AC Adaptor, Input Rating: 100-240V- , 50/60Hz, N. America NEMA 1-15 Fixed, , Output Rating: 18.00W, 15.0V@1.2A, Pin Out: Center Positive (+V), symbol compliant with IEC 60417 symbol no. 5926, Output Configuration: 1500 mm, 20/2 Cond, UL 2468, Female Barrel 5.5*2.1*11mm w/ Spring Clip & Locking Notch or Equal, Ferrite: None, GlobTek Black, GT Cord # C5034, Blades/Input Cord: (Order Separately), Approvals: |       |
|  | Model No. GT-86181-1815 -W2   |       |
|  | Part No./Ordering No. WR9HG1200CCP-F(R6B)   | Rev A |

## REVISION HISTORY

| REV | DESCRIPTION     | SUB   | DATE       | APPROVED |
|-----|-----------------|-------|------------|----------|
| A   | Initial Release | fclif | 04/23/2019 | QA       |

### POWER SUPPLY INFORMATION

|                                |  |
|--------------------------------|--|
| TYPE                           | Wall Plug-in   |
| TECHNOLOGY                     | Regulated Switchmode AC-DC Power Supply AC Adaptor   |
| CASE COLOR                     | GlobTek Black  |
| NAMEPLATE RATED INPUT          | 100-240V- , 50/60Hz, 0.6 A   |
| INPUT CONFIG                   | N. America NEMA 1-15 Fixed   |
| WATTS                          | 18.00  |
| VOLTS OUT                      | 15.0   |
| CURRENT OUT (Amps)             | 1.2  |
| BLADE/CORD INCLUDED            | None (Order Separately)  |
| BLADE/CORD INSTALLED           | None :(Order Separately)   |
| INGRESS PROTECTION             | Indoor Use   |
| GROUNDING CONFIGURATION        | (F1) Floating output, Class II / double insulated  |
| EFFICIENCY LEVEL               | USA DOE Level VI / Eco-design Directive 2009/125/EC, (EU) 2019/1782  |
| OUTPUT CONFIGURATION           | 1500 mm, 20/2 Cond, UL 2468, Female Barrel 5.5*2.1*11mm w/ Spring Clip & Locking Notch or Equal, Ferrite: None, GlobTek Black, GT Cord # C5034 |
| OVERMOLDED                     | Yes  |
| OUTPUT CONNECTOR GENDER        | Female   |
| CONNECTOR PIN OUT              | Center Positive (+V), symbol compliant with IEC 60417 symbol no. 5926  |
| LABEL SPECS                    | Standard GT,L-1186   |
| SPECIAL BARCODE LABEL MATERIAL | No   |
| PACK SPEC                      | Standard WPI, Cellular packaging   |
| USER MANUAL                    |  |

#### PROPRIETARY INFORMATION

|  |  |
|--|--|
| <p>GlobTek, Inc.<br/> www.globtek.com<br/> 186 Veterans Drive,<br/> Northvale, NJ 07647<br/> Tel. (201) 784-1000<br/> Fax (201) 784-0111</p> | <p>Drawing Title: GT-86181-1815 -W2, ICT/ITE Power Supply, Efficiency Level: USA DOE Level VI / Eco-design Directive 2009/125/EC, (EU) 2019/1782, Case Color/Style: GlobTek Black, Wall Plug-in, Regulated Switchmode AC-DC Power Supply AC Adaptor, Input Rating: 100-240V- , 50/60Hz, N. America NEMA 1-15 Fixed, , Output Rating: 18.00W, 15.0V@1.2A, Pin Out: Center Positive (+V), symbol compliant with IEC 60417 symbol no. 5926, Output Configuration: 1500 mm, 20/2 Cond, UL 2468, Female Barrel 5.5*2.1*11mm w/ Spring Clip &amp; Locking Notch or Equal, Ferrite: None, GlobTek Black, GT Cord # C5034, Blades/Input Cord: (Order Separately), Approvals:</p> |
|  | <p>Model No. GT-86181-1815 -W2</p>   |
|  | <p>Part No./Ordering No. WR9HG1200CCP-F(R6B) <span style="float: right;">Rev A</span></p>  |

Notes/Modifications/Customizations (notes in this section supersede the values shown in the standard spec)  
DIMENSIONS ARE IN MM UNLESS SPECIFIED OTHERWISE

|   |   |       |
|---|---|-------|
| GloBtek, Inc.<br>www.globtek.com<br>186 Veterans Drive,<br>Northvale, NJ 07647<br>Tel. (201) 784-1000<br>Fax (201) 784-0111 | Drawing Title: GT-86181-1815 -W2, ICT/ITE Power Supply, Efficiency Level: USA DOE Level VI / Eco-design Directive 2009/125/EC, (EU) 2019/1782, Case Color/Style: GlobTek Black, Wall Plug-in, Regulated Switchmode AC-DC Power Supply AC Adaptor, Input Rating: 100-240V- , 50/60Hz, N. America NEMA 1-15 Fixed, , Output Rating: 18.00W, 15.0V@1.2A, Pin Out: Center Positive (+V), symbol compliant with IEC 60417 symbol no. 5926, Output Configuration: 1500 mm, 20/2 Cond, UL 2468, Female Barrel 5.5*2.1*11mm w/ Spring Clip & Locking Notch or Equal, Ferrite: None, GlobTek Black, GT Cord # C5034, Blades/Input Cord: (Order Separately), Approvals: |       |
|   | Model No. GT-86181-1815 -W2   |       |
|   | Part No./Ordering No. WR9HG1200CCP-F(R6B)   | Rev A |

## ELECTRICAL SPECIFICATIONS

### A) ELECTRICAL SPECIFICATIONS:

01. Input Voltage: Specified 90-264 Vac, Nameplate rated: 100-240Vac
02. Input Frequency: Specified 47-63 Hz, Nameplate rated 50-60Hz
03. Inrush Current: at full load, 25° C, cold start
04. Efficiency: Compliant with Efficiency Level VI and CoC Tier 2 standards
05. No Load Standby Power: <0.075W @ 230Vac
06. Line regulation: ±2% At nominal input voltage and full load
07. Total output regulation: ± 5%
08. Output Voltage: Tolerance ± 5%
09. Turn On Delay: 3 Seconds maximum at nominal input Voltage
10. Hold Up Time: 5ms min at nominal Input Voltage
11. Ripple Voltage: 300 mVp-p At 20 MHz, and output parallel with Low Impedance 0.1uF & 47uF capacitors. Temperature at 25°C, and nominal input voltage

### B) PROTECTION

01. Over voltage protection: Output shut down and auto restart
02. Short circuit protection: The adapter shall not be damaged by short the DC output to Ground
03. Over Load Protection: Output shut down and auto restart

### C) SAFETY

01. HI-POT : Input to output : 3000VAC or 4242VDC 10mA 1 minute
02. Leakage current: 0.25mA maximum, at nominal AC input voltage and frequency
03. ESD: 8KV(air) / 4KV (contact)

### D) OTHER:

01. MTBF: 200,000 Hours @ 25°C ambient temperature
02. Operating Temperature: 0°C to 40°C ambient temperature
03. Humidity Operating : 20% to 85%
04. Storage Temperature: -20°C to 60°C
05. RoHS 2: Complies with EU 2011/65/EU and China GB/T26572-2011

### E) ENCLOSURE

01. Housing: High impact plastic, 94V0 polycarbonate, non-vented
02. Size: 74.5 (L) \* 36 (W) \* 46(H) mm maximum
03. Weight : 107.0 g ±15%
04. Markings: Label and/or Pad Printed and/or Molded in the case

TO ADDRESS SYSTEM-LEVEL EMI CONCERNS, FERRITE CHOKES/BEADS MAY BE ADDED/REVISED UPON REQUEST. A SAMPLE KIT OF GLOBTEK'S STANDARD FERRITES IS AVAILABLE UNDER GLOBTEK P/N: EMI-MITIGATION-KIT1

FOR ADDITIONAL INFORMATION, PLEASE READ OUR WHITE PAPER AT: <https://r.globtek.info/3QeaqtD>

#### PROPRIETARY INFORMATION

PROPRIETARY OF GLOBTEK, INC. ANY REPRODUCTION, DISCLOSURE OR USE OF THIS DRAWING, IN WHOLE OR IN PART, IS HEREBY PROHIBITED EXCEPT AS SPECIFIED IN WRITING BY GLOBTEK, INC. © GlobTek, Inc. 2019 - 2024

quest / 07/13/2024 7:31:52 AM GMT CLONED FROM WR9HG1200LCP-F(R6B)

|  |  |
|--|--|
| <p>GlobTek, Inc.<br/> www.globtek.com<br/> 186 Veterans Drive,<br/> Northvale, NJ 07647<br/> Tel. (201) 784-1000<br/> Fax (201) 784-0111</p> | <p>Drawing Title: GT-86181-1815 -W2, ICT/ITE Power Supply, Efficiency Level: USA DOE Level VI / Eco-design Directive 2009/125/EC, (EU) 2019/1782, Case Color/Style: GlobTek Black, Wall Plug-in, Regulated Switchmode AC-DC Power Supply AC Adaptor, Input Rating: 100-240V- , 50/60Hz, N. America NEMA 1-15 Fixed, , Output Rating: 18.00W, 15.0V@1.2A, Pin Out: Center Positive (+V), symbol compliant with IEC 60417 symbol no. 5926, Output Configuration: 1500 mm, 20/2 Cond, UL 2468, Female Barrel 5.5*2.1*11mm w/ Spring Clip &amp; Locking Notch or Equal, Ferrite: None, GlobTek Black, GT Cord # C5034, Blades/Input Cord: (Order Separately), Approvals:</p> |
|  | <p>Model No. GT-86181-1815 -W2</p>   |
|  | <p>Part No./Ordering No. WR9HG1200CCP-F(R6B) <span style="float: right;">Rev A</span></p>  |

INGRESS PROTECTION: Indoor Use

|  |  |              |
|--|--|--------------|
| <p>GlobTek, Inc.<br/> www.globtek.com<br/> 186 Veterans Drive,<br/> Northvale, NJ 07647<br/> Tel. (201) 784-1000<br/> Fax (201) 784-0111</p> | <p>Drawing Title: GT-86181-1815 -W2, ICT/ITE Power Supply, Efficiency Level: USA DOE Level VI / Eco-design Directive 2009/125/EC, (EU) 2019/1782, Case Color/Style: GlobTek Black, Wall Plug-in, Regulated Switchmode AC-DC Power Supply AC Adaptor, Input Rating: 100-240V- , 50/60Hz, N. America NEMA 1-15 Fixed, , Output Rating: 18.00W, 15.0V@1.2A, Pin Out: Center Positive (+V), symbol compliant with IEC 60417 symbol no. 5926, Output Configuration: 1500 mm, 20/2 Cond, UL 2468, Female Barrel 5.5*2.1*11mm w/ Spring Clip &amp; Locking Notch or Equal, Ferrite: None, GlobTek Black, GT Cord # C5034, Blades/Input Cord: (Order Separately), Approvals:</p> <p>Model No. GT-86181-1815 -W2</p> <p>Part No./Ordering No. WR9HG1200CCP-F(R6B)</p> | <p>Rev A</p> |
|--|--|--------------|

3D File Download [https://www.globtek.com/file/dl/6014\\_obsolete\\_model.stp](https://www.globtek.com/file/dl/6014_obsolete_model.stp)

Mechanical drawing

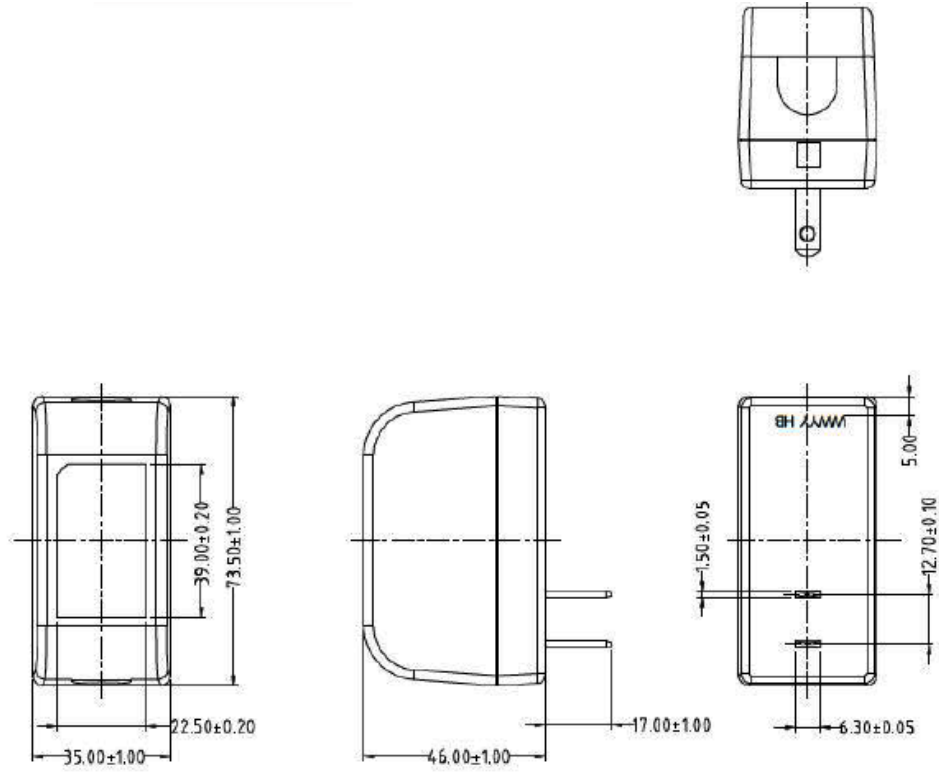

GlobTek, Inc.  
 www.globtek.com  
 186 Veterans Drive,  
 Northvale, NJ 07647  
 Tel. (201) 784-1000  
 Fax (201) 784-0111

Drawing Title: GT-86181-1815 -W2, ICT/ITE Power Supply, Efficiency Level: USA DOE Level VI / Eco-design Directive 2009/125/EC, (EU) 2019/1782, Case Color/Style: GlobTek Black, Wall Plug-in, Regulated Switchmode AC-DC Power Supply AC Adaptor, Input Rating: 100-240V- , 50/60Hz, N. America NEMA 1-15 Fixed, , Output Rating: 18.00W, 15.0V@1.2A, Pin Out: Center Positive (+V), symbol compliant with IEC 60417 symbol no. 5926, Output Configuration: 1500 mm, 20/2 Cond, UL 2468, Female Barrel 5.5\*2.1\*11mm w/ Spring Clip & Locking Notch or Equal, Ferrite: None, GlobTek Black, GT Cord # C5034, Blades/Input Cord: (Order Separately), Approvals:

Model No. GT-86181-1815 -W2

Part No./Ordering No. WR9HG1200CCP-F(R6B) Rev A

DERATING CURVE

w2

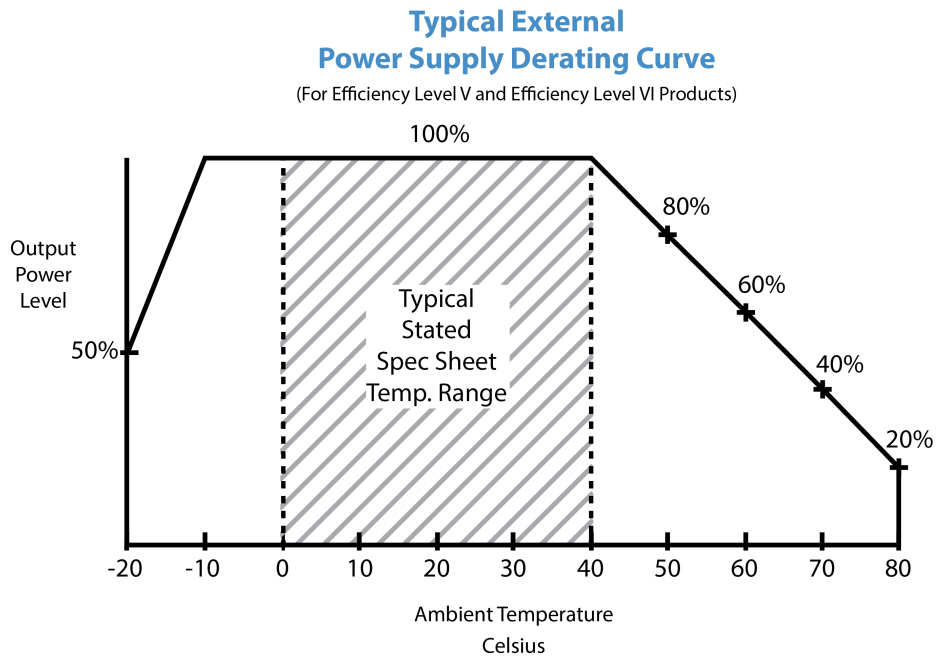

|  |   |
|--|---|
| <p>GlobTek, Inc.<br/> www.globtek.com<br/> 186 Veterans Drive,<br/> Northvale, NJ 07647<br/> Tel. (201) 784-1000<br/> Fax (201) 784-0111</p> | <p>Drawing Title: GT-86181-1815 -W2, ICT/ITE Power Supply, Efficiency Level: USA DOE Level VI / Eco-design Directive 2009/125/EC, (EU) 2019/1782, Case Color/Style: GlobTek Black, Wall Plug-in, Regulated Switchmode AC-DC Power Supply AC Adaptor, Input Rating: 100-240V- , 50/60Hz, N. America NEMA 1-15 Fixed, , Output Rating: 18.00W, 15.0V@1.2A, Pin Out: Center Positive (+V), symbol compliant with IEC 60417 symbol no. 5926, Output Configuration: 1500 mm, 20/2 Cond, UL 2468, Female Barrel 5.5*2.1*11mm w/ Spring Clip &amp; Locking Notch or Equal, Ferrite: None, GlobTek Black, GT Cord # C5034, Blades/Input Cord: (Order Separately), Approvals:</p> <p>Model No. GT-86181-1815 -W2</p> <p>Part No./Ordering No. WR9HG1200CCP-F(R6B) <span style="float: right;">Rev A</span></p> |
|--|---|

## INPUT CONFIGURATION

(F1) Floating output, Class II / double insulated

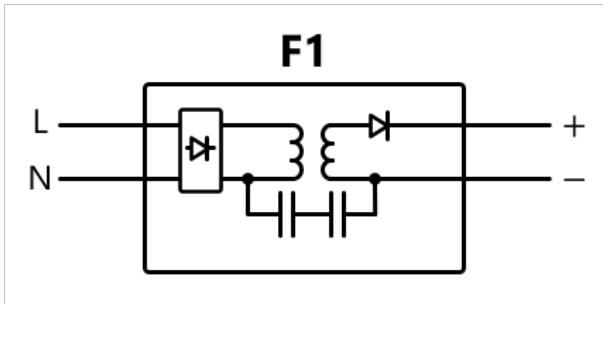

[Alternate grounding configurations](#) available upon request.

Blades/Cord Included:None:(Order Separately)

Blades/Cord Installed:None:(Order Separately)

NEMA 1-15P

NEMA 1-15P, North America Blades, Class II 2 Conductors

All NEMA 1 devices are two-wire non-grounding devices (hot-neutral) rated for 125 V maximum. NEMA 1-15P plugs have two parallel flat blades, 0.25 inches (6.35 mm) wide, 0.06 inches (1.524 mm) thick, 0.625-0.718 inches (15.875–18.256 mm) long, and spaced 0.5 inches (12.7 mm) apart.



|   |   |       |
|---|---|-------|
| GlobTek, Inc.<br>www.globtek.com<br>186 Veterans Drive,<br>Northvale, NJ 07647<br>Tel. (201) 784-1000<br>Fax (201) 784-0111 | Drawing Title: GT-86181-1815 -W2, ICT/ITE Power Supply, Efficiency Level: USA DOE Level VI / Eco-design Directive 2009/125/EC, (EU) 2019/1782, Case Color/Style: GlobTek Black, Wall Plug-in, Regulated Switchmode AC-DC Power Supply AC Adaptor, Input Rating: 100-240V- , 50/60Hz, N. America NEMA 1-15 Fixed, , Output Rating: 18.00W, 15.0V@1.2A, Pin Out: Center Positive (+V), symbol compliant with IEC 60417 symbol no. 5926, Output Configuration: 1500 mm, 20/2 Cond, UL 2468, Female Barrel 5.5*2.1*11mm w/ Spring Clip & Locking Notch or Equal, Ferrite: None, GlobTek Black, GT Cord # C5034, Blades/Input Cord: (Order Separately), Approvals: |       |
|   | Model No. GT-86181-1815 -W2   |       |
|   | Part No./Ordering No. WR9HG1200CCP-F(R6B)   | Rev A |

**OUTPUT CORD AND CONNECTOR: CL1/C5034**

ACTUAL CONNECTORS, OVERMOLDS, FERRITES MAY VARY SLIGHTLY FROM THE PICTURE BELOW

|  |   |
|--|---|
| CABLE TYPE   | UL 2468   |
| CABLE LENGTH (mm)                                    | 1500  |
| CABLE TOLERANCE (mm)                                 | +150-0  |
| WIRE GAUGE (AWG)                                     | 20  |
| CONDUCTORS   | 2   |
| HANK DIMENSION (mm)                                  | 70 ± 10   |
| CABLE / CONNECTOR OVERMOLD COLOR                     | GlobTek Black   |
| FERRITE TYPE AND DIMENSION                           | None  |
| FERRITE NUMBER OF TURNS <a href="#">(Definition)</a> | N/A   |
| FERRITE DIMENSION FROM STRAIN RELIEF                 | N/A   |
| FERRITE DIMENSION FROM PLUG                          | N/A   |
| PLUG TYPE  | Female Barrel 5.5*2.1*11mm w/ Spring Clip & Locking Notch or Equal    |
| OUTPUT CONNECTOR GENDER                              | Female  |
| OVERMOLDED   | Yes   |
| OVER MOLD ORIENTATION                                | Straight  |
| CONNECTOR PIN OUT                                    | Center Positive (+V), symbol compliant with IEC 60417 symbol no. 5926 |

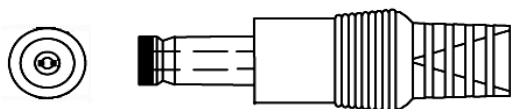

ADDITIONAL OUTPUT PLUG OPTIONS ARE AVAILABLE AT <https://www.globtek.com/en/connectors>  
STANDARD PLUGS AND CONNECTORS CAN BE SEEN ONLINE AT <https://www.globtek.com/en/connectors>  
CALCULATE VOLTAGE REGULATION/DROP WITH OUR ONLINE CALCULATOR: <https://www.globtek.com/r2/PtgijL>

|   |   |       |
|---|---|-------|
| GlobTek, Inc.<br>www.globtek.com<br>186 Veterans Drive,<br>Northvale, NJ 07647<br>Tel. (201) 784-1000<br>Fax (201) 784-0111 | Drawing Title: GT-86181-1815 -W2, ICT/ITE Power Supply, Efficiency Level: USA DOE Level VI / Eco-design Directive 2009/125/EC, (EU) 2019/1782, Case Color/Style: GlobTek Black, Wall Plug-in, Regulated Switchmode AC-DC Power Supply AC Adaptor, Input Rating: 100-240V- , 50/60Hz, N. America NEMA 1-15 Fixed, , Output Rating: 18.00W, 15.0V@1.2A, Pin Out: Center Positive (+V), symbol compliant with IEC 60417 symbol no. 5926, Output Configuration: 1500 mm, 20/2 Cond, UL 2468, Female Barrel 5.5*2.1*11mm w/ Spring Clip & Locking Notch or Equal, Ferrite: None, GlobTek Black, GT Cord # C5034, Blades/Input Cord: (Order Separately), Approvals: |       |
|   | Model No. GT-86181-1815 -W2   |       |
|   | Part No./Ordering No. WR9HG1200CCP-F(R6B)   | Rev A |

**OUTPUT CONNECTOR HOOK UP**

TO ADDRESS SYSTEM-LEVEL EMI CONCERNS, FERRITE CHOKES/BEADS MAY BE ADDED/REVISED UPON REQUEST. A SAMPLE KIT OF GLOBTEK'S STANDARD FERRITES IS AVAILABLE UNDER GLOBTEK P/N: EMI-MITIGATION-KIT1

FOR ADDITIONAL INFORMATION, PLEASE READ OUR WHITE PAPER AT:

<https://www.globtek.com/en/technical-articles/ferrite-kit-radiated-emi-suppression-kit-for-globtek-power-supplies-cable-assemblies>

|  |   |       |
|--|---|-------|
| <b>GlobTek, Inc.</b><br>www.globtek.com<br>186 Veterans Drive,<br>Northvale, NJ 07647<br>Tel. (201) 784-1000<br>Fax (201) 784-0111 | Drawing Title: GT-86181-1815 -W2, ICT/ITE Power Supply, Efficiency Level: USA DOE Level VI / Eco-design Directive 2009/125/EC, (EU) 2019/1782, Case Color/Style: GlobTek Black, Wall Plug-in, Regulated Switchmode AC-DC Power Supply AC Adaptor, Input Rating: 100-240V- , 50/60Hz, N. America NEMA 1-15 Fixed, , Output Rating: 18.00W, 15.0V@1.2A, Pin Out: Center Positive (+V), symbol compliant with IEC 60417 symbol no. 5926, Output Configuration: 1500 mm, 20/2 Cond, UL 2468, Female Barrel 5.5*2.1*11mm w/ Spring Clip & Locking Notch or Equal, Ferrite: None, GlobTek Black, GT Cord # C5034, Blades/Input Cord: (Order Separately), Approvals: |       |
|  | Model No. GT-86181-1815 -W2   |       |
|  | Part No./Ordering No. WR9HG1200CCP-F(R6B)   | Rev A |

**LABEL:L-1186**

|                                |  |
|--------------------------------|--|
| LABEL P/N                      | Standard GT  |
| MATERIAL                       | Flat Thermal Transfer, Imprintable, Polyester Label and/or Pad Printed and/or Molded, and/or Laser Engraved in the case                    |
| BACKGROUND COLOR               | Black if housing is Black, White or Silver if housing is White or Gray.  |
| TEXT COLOR                     | White or Silver if label is Black Background for Black housing. Black if label is White or Silver background and Housing is White or Gray. |
| LABEL WIDTH (mm)               | 38.6   |
| LABEL HEIGHT (mm)              | 22.1   |
| SPECIAL BARCODE LABEL MATERIAL | No   |

Below is the minimum information which will appear on the label. NOTE: in the logo area additional/actual positioning of symbols and text is subjected to change as per agency updates/requirements or additional model approvals become available. Regulatory certifications/label markings may be in logo area on the label or molded into the case housing outside the label area. Information will be shown via label and/or pad printed and/or molded and/or laser engraved in the case. \* Date code markings at GlobTek option

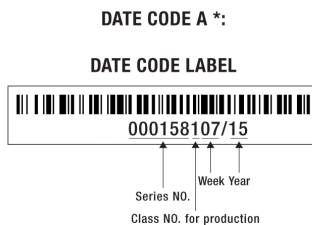

or  
**DATE CODE B \*:**

**WWYY**  
 WW = WEEK  
 YY = YEAR

- A=ICT/ITE Power Supply
- B=P/N: (料号) WR9HG1200CCP-F(R6B)
- C=Model (型号) GT-86181-1815 -W2
- D=Input (输入)100-240V- , 50/60Hz, 0.6 A
- E=Output (输出)15.0 V  $\equiv$  1.2 A, 18.00W

|   |   |       |
|---|---|-------|
| GlobTek, Inc.<br>www.globtek.com<br>186 Veterans Drive,<br>Northvale, NJ 07647<br>Tel. (201) 784-1000<br>Fax (201) 784-0111 | Drawing Title: GT-86181-1815 -W2, ICT/ITE Power Supply, Efficiency Level: USA DOE Level VI / Eco-design Directive 2009/125/EC, (EU) 2019/1782, Case Color/Style: GlobTek Black, Wall Plug-in, Regulated Switchmode AC-DC Power Supply AC Adaptor, Input Rating: 100-240V- , 50/60Hz, N. America NEMA 1-15 Fixed, , Output Rating: 18.00W, 15.0V@1.2A, Pin Out: Center Positive (+V), symbol compliant with IEC 60417 symbol no. 5926, Output Configuration: 1500 mm, 20/2 Cond, UL 2468, Female Barrel 5.5*2.1*11mm w/ Spring Clip & Locking Notch or Equal, Ferrite: None, GlobTek Black, GT Cord # C5034, Blades/Input Cord: (Order Separately), Approvals: |       |
|   | Model No. GT-86181-1815 -W2   |       |
|   | Part No./Ordering No. WR9HG1200CCP-F(R6B)   | Rev A |

|   |   |
|---|---|
| AGENCY ONLINE DOCUMENTS                         | <a href="http://www.globtek.info/certs/GT-86181-W2/">http://www.globtek.info/certs/GT-86181-W2/</a>   |
| CE EC-Declaration for Medical                   | <a href="#">Contact GlobTek for more information</a>  |
| CE EC-Declaration for Industrial/Commercial/ITE | <a href="https://cs.globtek.info/ec_declaration_product?id=01t0c0000097COD&amp;i=2">https://cs.globtek.info/ec_declaration_product?id=01t0c0000097COD&amp;i=2</a>     |
| CE EC-Declaration for Household                 | <a href="#">Contact GlobTek for more information</a>  |
| UKCA-Declaration for Medical                    | <a href="#">Contact GlobTek for more information</a>  |
| UKCA-Declaration for Industrial/Commercial/ITE  | <a href="https://cs.globtek.info/ukca_declaration_product?id=01t0c0000097COD&amp;i=2">https://cs.globtek.info/ukca_declaration_product?id=01t0c0000097COD&amp;i=2</a> |
| UKCA-Declaration for Household                  | <a href="#">Contact GlobTek for more information</a>  |
| Morocco SDoC Declaration                        | <a href="https://cs.globtek.info/Morocco_SDoC_Declaration?id=a0Oa000000FlgfoEAB">https://cs.globtek.info/Morocco_SDoC_Declaration?id=a0Oa000000FlgfoEAB</a>           |
| RoHS/RoHS3 Declaration                          | <a href="https://www.globtek.com/pdf/rohs_cert/01t0c0000097CODAA2">https://www.globtek.com/pdf/rohs_cert/01t0c0000097CODAA2</a>                                       |
| REACH Declaration                               | <a href="https://www.globtek.com/pdf/iso_certificates/REACH.pdf">https://www.globtek.com/pdf/iso_certificates/REACH.pdf</a>   |
| Conflict Minerals Declaration                   | <a href="https://www.globtek.com/pdf/conflict-minerals.pdf">https://www.globtek.com/pdf/conflict-minerals.pdf</a>   |
| Prop 65 Statement                               | <a href="https://www.globtek.com/prop-65-statement.pdf">https://www.globtek.com/prop-65-statement.pdf</a>   |

IPXY rating is based on 3rd party testing and customers should check suitability and test system level IPXY rating before ordering.

## Regulatory Certifications/Label Markings

Below follows a link to the latest regulatory certifications and marks for this specific product. National standards as well as certification schemes are constantly changing and so is the set of certification marks and symbols applicable to this product. Various standards, marks and symbols, and certificates are subject to change at any time without notice.

Additional standards or unique country certifications are available upon request. Please contact Globtek to request a quotation.

LATEST PRODUCT/MODEL CERTIFICATIONS: <https://www.globtek.com/ds/f7LDNw39di2/WckbGQUcPmH.html>

AGENCY ONLINE DOCUMENTS <http://www.globtek.info/certs/GT-86181-W2/>  
(F1) Floating output, Class II / double insulated

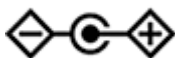

Center Positive (+V), symbol compliant with IEC 60417 symbol no. 5926

|   |   |       |
|---|---|-------|
| GlobTek, Inc.<br>www.globtek.com<br>186 Veterans Drive,<br>Northvale, NJ 07647<br>Tel. (201) 784-1000<br>Fax (201) 784-0111 | Drawing Title: GT-86181-1815 -W2, ICT/ITE Power Supply, Efficiency Level: USA DOE Level VI / Eco-design Directive 2009/125/EC, (EU) 2019/1782, Case Color/Style: GlobTek Black, Wall Plug-in, Regulated Switchmode AC-DC Power Supply AC Adaptor, Input Rating: 100-240V- , 50/60Hz, N. America NEMA 1-15 Fixed, , Output Rating: 18.00W, 15.0V@1.2A, Pin Out: Center Positive (+V), symbol compliant with IEC 60417 symbol no. 5926, Output Configuration: 1500 mm, 20/2 Cond, UL 2468, Female Barrel 5.5*2.1*11mm w/ Spring Clip & Locking Notch or Equal, Ferrite: None, GlobTek Black, GT Cord # C5034, Blades/Input Cord: (Order Separately), Approvals: |       |
|   | Model No. GT-86181-1815 -W2   |       |
|   | Part No./Ordering No. WR9HG1200CCP-F(R6B)   | Rev A |

## PACKAGING

|                                 |                                  |
|---------------------------------|----------------------------------|
| Packing Spec P/N                | Standard WPI, Cellular packaging |
| Packing Quantity/Multiple/MPQ   | 120                              |
| Gift Box Size (mm)              | Cellular Packaing                |
| Gift Box Color                  | None                             |
| Master Carton Size (mm)         | 525 x 335 x 300                  |
| Master Carton Cubic Volume (m³) | 0.05                             |
| Master GW (Kg)                  | 0.0 kg                           |
| BLADES INCLUDED                 | None: (Order Separately)         |
| BLADE/CORD INSTALLED            | None: (Order Separately)         |
| USER MANUAL*                    |                                  |
| USER MANUAL WEB LINK            |                                  |

\* This specification sheet is considered the user manual for all applications. It is expected that the buyer of this product will use it to formulate their own user manual for their end product and a user manual specifically for the power adapter is not usually required. If a user manual is not specifically listed above then none will be provided with this unit.

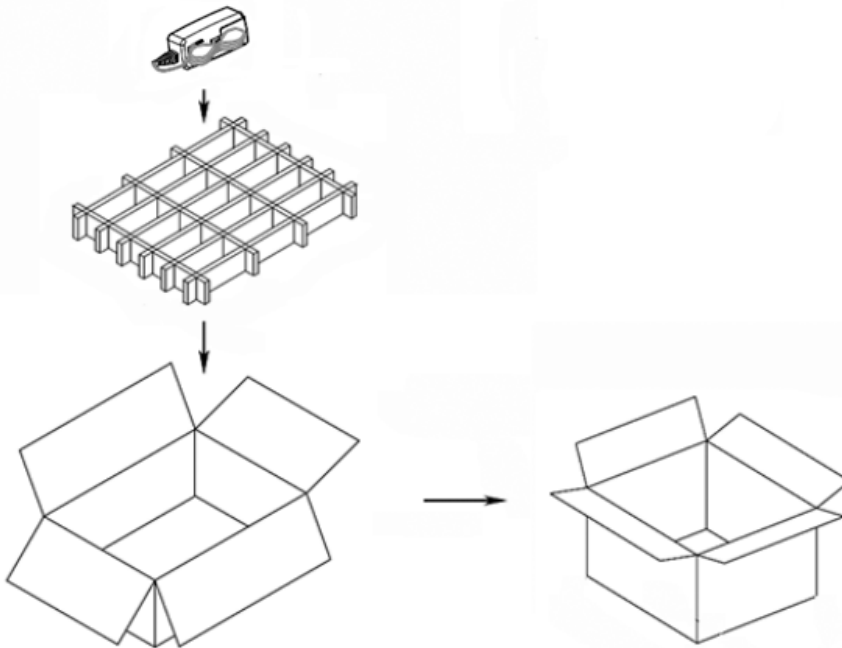

### PROPRIETARY INFORMATION

|   |   |       |
|---|---|-------|
| GlobTek, Inc.<br>www.globtek.com<br>186 Veterans Drive,<br>Northvale, NJ 07647<br>Tel. (201) 784-1000<br>Fax (201) 784-0111 | Drawing Title: GT-86181-1815 -W2, ICT/ITE Power Supply, Efficiency Level: USA DOE Level VI / Eco-design Directive 2009/125/EC, (EU) 2019/1782, Case Color/Style: GlobTek Black, Wall Plug-in, Regulated Switchmode AC-DC Power Supply AC Adaptor, Input Rating: 100-240V- , 50/60Hz, N. America NEMA 1-15 Fixed, , Output Rating: 18.00W, 15.0V@1.2A, Pin Out: Center Positive (+V), symbol compliant with IEC 60417 symbol no. 5926, Output Configuration: 1500 mm, 20/2 Cond, UL 2468, Female Barrel 5.5*2.1*11mm w/ Spring Clip & Locking Notch or Equal, Ferrite: None, GlobTek Black, GT Cord # C5034, Blades/Input Cord: (Order Separately), Approvals: |       |
|   | Model No. GT-86181-1815 -W2   |       |
|   | Part No./Ordering No. WR9HG1200CCP-F(R6B)   | Rev A |

## INSTRUCTIONS TO THE OEM SYSTEMS ENGINEER

It is the responsibility of the OEM systems engineer to provide the end system user instructions and warnings for the use of this product in the end system.

If an input cord is required for this product, AC Mains voltage should be provided to the power supply by a power supply cord approved to the national standards of the country in which it will be used.

This product is not designed to be repaired. No serviceable parts inside. A blown internal fuse is an indication of catastrophic failure of circuit component(s). If a Failure Analysis is required for a failed power supply/battery charger, please return the damaged unit to GlobTek for an accurate determination of the root cause of the failure.

EMC Compliance of the complete OEM product, including the GlobTek power supply/battery charger needs to be verified by the OEM systems engineer.

|   |   |       |
|---|---|-------|
| GlobTek, Inc.<br>www.globtek.com<br>186 Veterans Drive,<br>Northvale, NJ 07647<br>Tel. (201) 784-1000<br>Fax (201) 784-0111 | Drawing Title: GT-86181-1815 -W2, ICT/ITE Power Supply, Efficiency Level: USA DOE Level VI / Eco-design Directive 2009/125/EC, (EU) 2019/1782, Case Color/Style: GlobTek Black, Wall Plug-in, Regulated Switchmode AC-DC Power Supply AC Adaptor, Input Rating: 100-240V- , 50/60Hz, N. America NEMA 1-15 Fixed, , Output Rating: 18.00W, 15.0V@1.2A, Pin Out: Center Positive (+V), symbol compliant with IEC 60417 symbol no. 5926, Output Configuration: 1500 mm, 20/2 Cond, UL 2468, Female Barrel 5.5*2.1*11mm w/ Spring Clip & Locking Notch or Equal, Ferrite: None, GlobTek Black, GT Cord # C5034, Blades/Input Cord: (Order Separately), Approvals: |       |
|   | Model No. GT-86181-1815 -W2   |       |
|   | Part No./Ordering No. WR9HG1200CCP-F(R6B)   | Rev A |

INSTRUCTION SHEET

|  |  |
|--|--|
| <p>GlobTek, Inc.<br/> www.globtek.com<br/> 186 Veterans Drive,<br/> Northvale, NJ 07647<br/> Tel. (201) 784-1000<br/> Fax (201) 784-0111</p> | <p>Drawing Title: GT-86181-1815 -W2, ICT/ITE Power Supply, Efficiency Level: USA DOE Level VI / Eco-design Directive 2009/125/EC, (EU) 2019/1782, Case Color/Style: GlobTek Black, Wall Plug-in, Regulated Switchmode AC-DC Power Supply AC Adaptor, Input Rating: 100-240V- , 50/60Hz, N. America NEMA 1-15 Fixed, , Output Rating: 18.00W, 15.0V@1.2A, Pin Out: Center Positive (+V), symbol compliant with IEC 60417 symbol no. 5926, Output Configuration: 1500 mm, 20/2 Cond, UL 2468, Female Barrel 5.5*2.1*11mm w/ Spring Clip &amp; Locking Notch or Equal, Ferrite: None, GlobTek Black, GT Cord # C5034, Blades/Input Cord: (Order Separately), Approvals:</p> |
|  | <p>Model No. GT-86181-1815 -W2</p>   |
|  | <p>Part No./Ordering No. WR9HG1200CCP-F(R6B) <span style="float: right;">Rev A</span></p>  |

