

Circuit Breaker for Equipment thermal, 2 pole, Push button actuation, with undervoltage



See below:

Approvals and Compliances

Description

- Thermal circuit breaker
- 1 or 2 pole thermal overload protection
- Positively trip-free release
- High configurability
- Snap-in or flange mounted
- Quick connect terminal 6.3 x 0.8 mm or screw clamp terminal M3.5 x 6 mm (lineside P1, P2)

Applications

- Power tools
- Industrial appliances
- Power supplies

Weblinks

[pdf datasheet](#), [html-datasheet](#), [General Product Information](#), [Distributor-Stock-Check](#), [Detailed request for product](#), [Product News](#)

Technical Data

Rated Voltage AC	240 V
Rated Voltage DC	60 V
Rated current range AC	0.05 - 20 A
Conditional short circuit capacity	IEC: Inc, PC1, AC 240 V: 1 kA
Degree of Protection	from front side IP 40 acc. to IEC 60529
Dielectric Strength	4 kV
Insulation Resistance	500VDC > 100 MΩ
Lifetime	mechanical: 50'000 switching cycles AC: 1 x Ir: 50'000 switching cycles DC: 1 x Ir: 50'000 switching cycles

Overload	AC: min. 40trips @ 6 x Ir DC: min. 50trips @ 4 x Ir
Ambient temperature	-10°C to 55°C
Vibration Resistance	± 0.75 mm @ 5 - 60 Hz acc. to IEC 60068-2-6, test Fc 10 G @ 60 - 500 Hz acc. to IEC 60068-2-6, test Fc
Shock Resistance	30 G / 18ms acc. to IEC 60068-2-27, test Ea
Possible Tripping Types	Thermal Undervoltage release Remote trip Mechanical lock-out latch
Actuation Type	Pushbutton
Weight	45 - 60g

Approvals and Compliances

Detailed information on product approvals, code requirements, usage instructions and detailed test conditions can be looked up in [Details about Approvals](#)





Approvals

The approval mark is used by the testing authorities to certify compliance with the safety requirements placed on electronic products.
 Approval Reference Type: TA45

Approval Logo	Certificates	Certification Body	Description
	VDE Approvals	VDE	VDE Certificate Number: 40019880
	UL Approvals	UL	UL File Number: E71572
	CQC Approvals	CQC	CCC Certificate Number: 2013010307660082

Product standards

Product standards that are referenced

Organization	Design	Standard	Description
	Designed according to	IEC 60934	Circuit-breakers for equipment (CBE)
	Designed according to	UL 1077	Standard for Supplementary Protectors for Use in Electrical Equipment
	Designed according to	CSA C22.2 No. 235	Supplementary Protectors
	Designed according to	GB 17701	Circuit-breaker for equipment





Application standards

Application standards where the product can be used

Organization	Design	Standard	Description
	Designed for applications acc.	IEC/UL 60950	IEC 60950-1 includes the basic requirements for the safety of information technology equipment.

Compliances

The product complies with following Guide Lines

Identification	Details	Initiator	Description
	CE declaration of conformity	SCHURTER AG	The CE marking declares that the product complies with the applicable requirements laid down in the harmonisation of Community legislation on its affixing in accordance with EU Regulation 765/2008.
	RoHS	SCHURTER AG	EU Directive RoHS 2011/65/EU
	China RoHS	SCHURTER AG	The law SJ / T 11363-2006 (China RoHS) has been in force since 1 March 2007. It is similar to the EU directive RoHS.
	REACH	SCHURTER AG	On 1 June 2007, Regulation (EC) No 1907/2006 on the Registration, Evaluation, Authorization and Restriction of Chemicals 1 (abbreviated as "REACH") entered into force.

Dimension [mm]

Snap-in type and quick connect terminal
 Undervoltage release, remote trip release

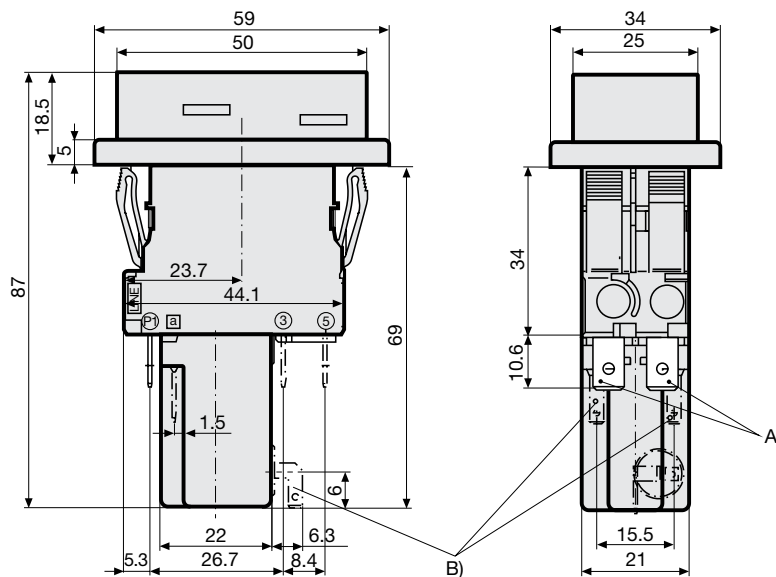

A) Quick connect terminal, IEC 61210, A6.3-0.8 mm

B) Quick connect terminal, IEC 61210, A2.8-0.8 mm

Snap-in type and quick connect terminal
 Mechanical lock-out latch

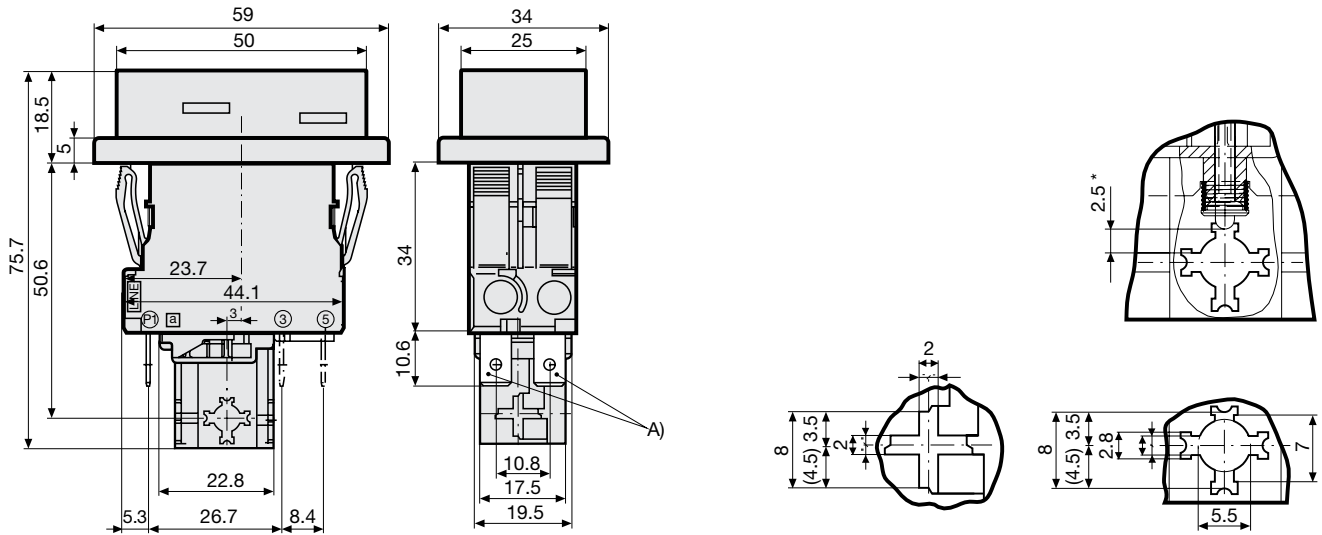

A) Quick connect terminal, IEC 61210, A6.3-0.8 mm

*) max. switching stroke

Flange type and quick connect terminal
 Undervoltage release, remote trip release

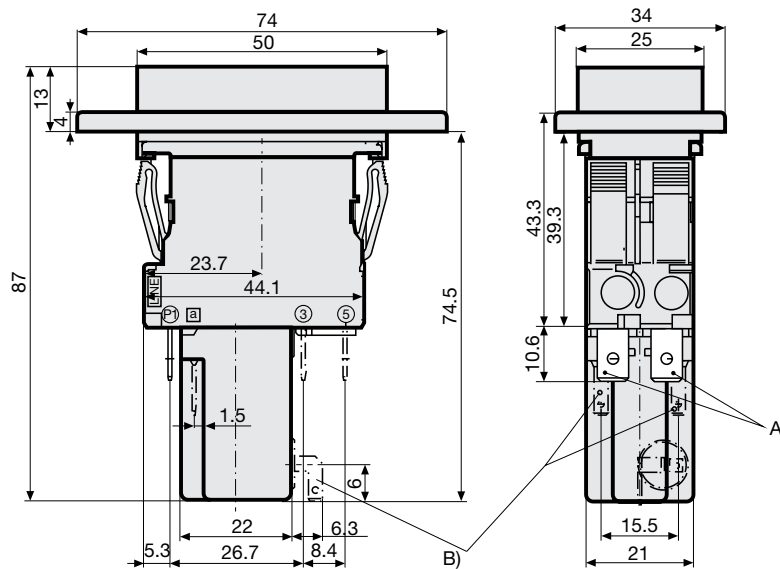

A) Quick connect terminal, IEC 61210, A6.3-0.8 mm

B) Quick connect terminal, IEC 61210, A2.8-0.8 mm

Flange type and quick connect terminal
 Mechanical lock-out latch

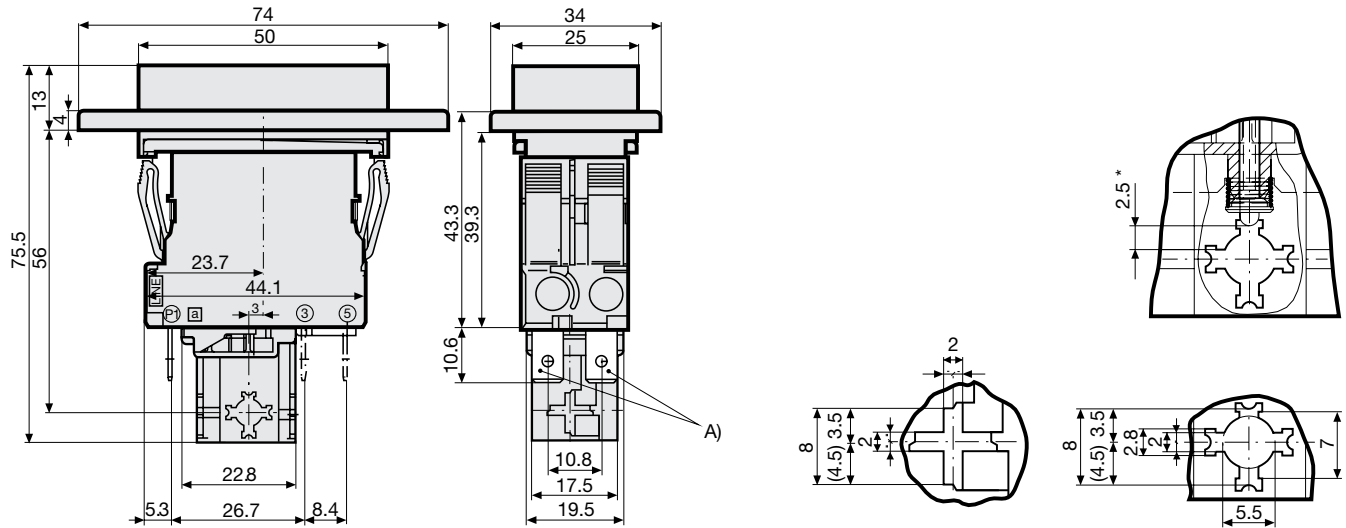

A) Quick connect terminal, IEC 61210, A6.3-0.8 mm

*) max. switching stroke

Cut-out and pin-out

Cut-out snap-in type

Cut-out flange type / Installation from rear

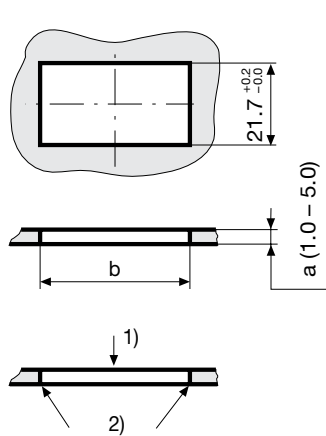

a	b
1.0	44,5...45,0
1.5	44,5...45,0
2.0	44,7...45,2
2.5	44,7...45,2
3.0	44,8...45,3
4.0	44,9...45,4
5.0	45,0...45,5

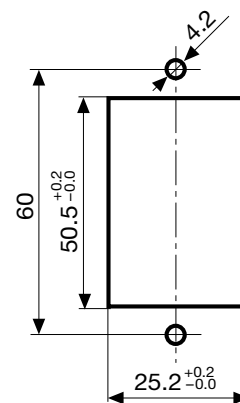

- 1) Assemble
- 2) edge must be sharp

Cut-out flange type/ Installation from rear with AZZ05 cover

Pin-out

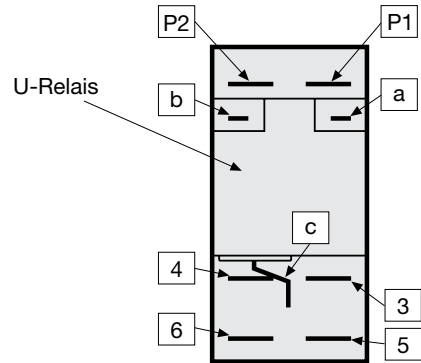
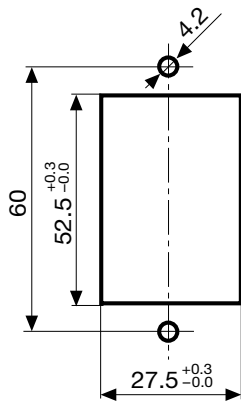

Diagrams

1 pole thermal overload protection

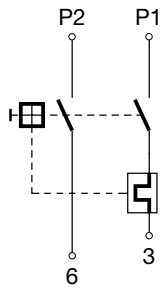

1 pole thermal overload protection, Shunt terminal

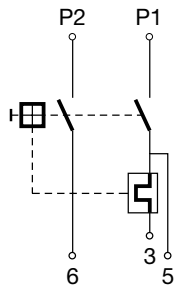

2 pole thermal overload protection

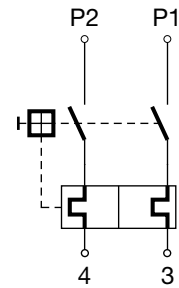

2 pole thermal overload protection, Shunt terminal

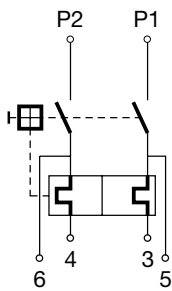

Undervoltage release

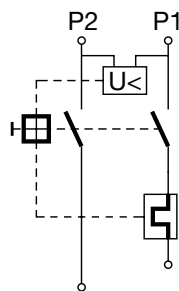

Undervoltage release with additional contact

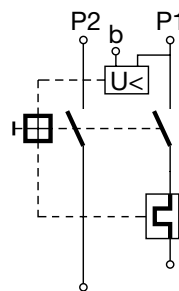

Undervoltage release with 2 additional contacts

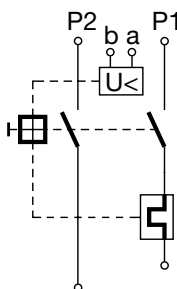

Remote trip release

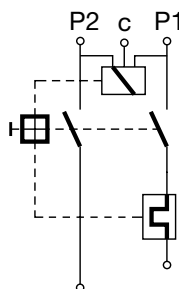

Mechanical lock-out latch

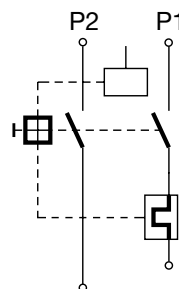

Effect of ambient temperature

The units are calibrated for an ambient temperature of +23°C. To determine the rated current for a lower or higher ambient temperature, use a correction factor (typical value) from the table below:

Ambient temperature [°C]	Correction factor
-10	0.89
-5	0.91
0	0.92
+23	1.00
+30	1.03
+40	1.08
+55	1.16

Example: Rated current = 5 A; Environmental temperature = 40 °C; --> Correction factor = 1.08; Resulting current = 5.5 A --> Fount to next higher rated current: 6 A

Undervoltage release

Max. operating voltage								1.1 Ue
Rated operating voltage Ue	5 V	12 V	24 V	48 V	120 V	240 V	400 V ¹⁾	
Current consumption (± 10%)	10.5 mA	16.5 mA	17.0 mA	3.2 mA	3.7 mA	3.1 mA	2.65 mA	
Highest reset level								0.85 Ue
Lowest trip level								0.20 Ue
Trip delay								20 ms - 50 ms
Impulse withstand voltage (1.2 / 50 µs)								≥4 kV
1) only for 3pole								

Remote trip

Permissible impuls duration of the make contact (no)	Between terminal C and P1	unlimited
Electrical load of the make contact (no)	Current max. 12 mA / power max. 1.1 W	

Time-Current-Curves

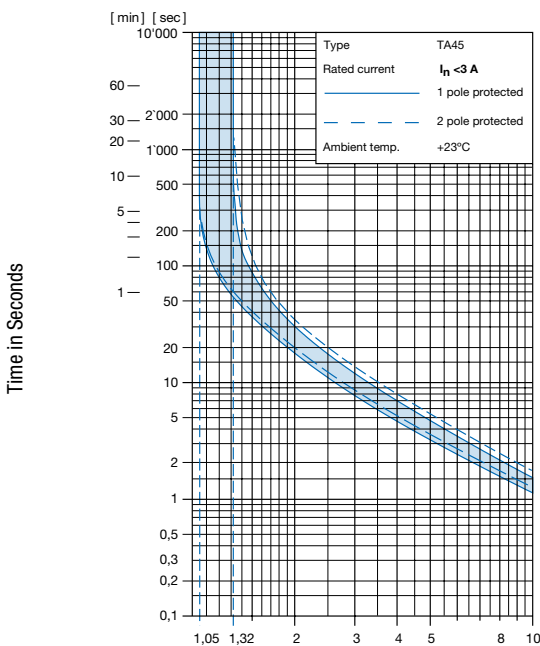

Multiple of Rated Current I_n

Reference Temperature +23°

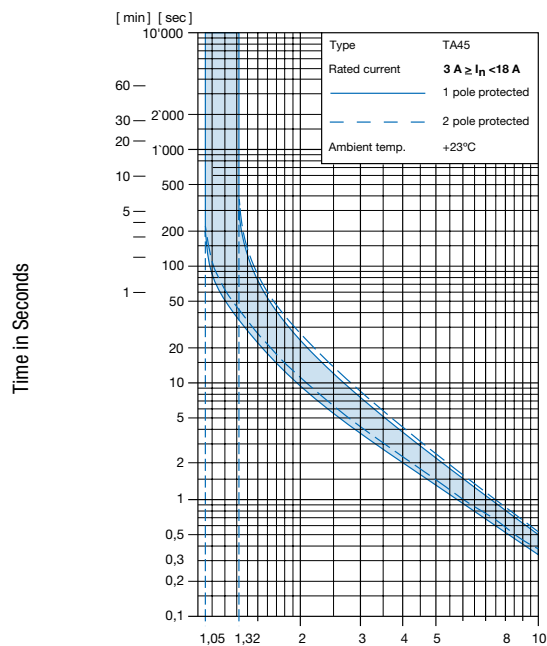

Multiple of Rated Current I_n

Reference Temperature +23°

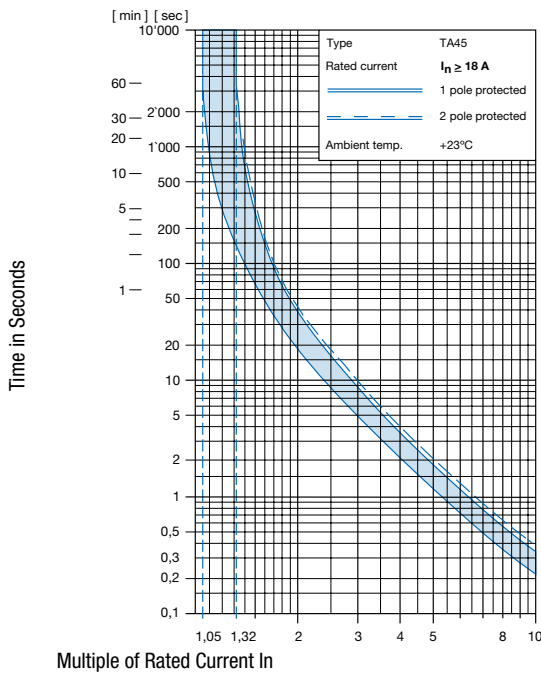

Multiple of Rated Current In
 Reference Temperature +23°

Config. Code

TA45 - AK2 W F 120 A2 - AZM11

The characters are placeholders for the correspondingly keys of selections from the key tables.

TA45 - **AK2** W F 120 A2 - AZM11 = Basic function







Basic function	Configuration key	Basic function	Configuration key
2-pole, push button, 1pole overload protection, flat connection, snap-in type, push button gasket IP40	ABL	2-pole, push button, 2pole overload protection, screw connection, snap-in type, push button gasket IP65	AEW
2-pole, push button, 1pole overload protection, shunt terminal, flat connection, snap-in type, push button gasket IP40	ABM	2-pole, push button, 2p overload protection, shunt terminal, screw connection, snap-in type, push button gasket IP65	AEX
2-pole, push button, 2pole overload protection, flat connection, snap-in type, push button gasket IP40	ABN	2-pole, push button, 1pole overload protection, flat connection, flange type, push button gasket IP40	AHL
2-pole, push button, 2p overload protection, shunt terminal, flat connection, snap-in type, push button gasket IP40	ABP	2-pole, push button, 1pole overload protection, shunt terminal, flat connection, flange type, push button gasket IP40	AHM
2-pole, push button, 1pole overload protection, flat connection, snap-in type, push button gasket IP65	ABU	2-pole, push button, 2pole overload protection, flat connection, flange type, push button gasket IP40	AHN
2-pole, push button, 1pole overload protection, shunt terminal, flat connection, snap-in type, push button gasket IP65	ABV	2-pole, push button, 2p overload protection, shunt terminal, flat connection, flange type, push button gasket IP40	AHP
2-pole, push button, 2pole overload protection, flat connection, snap-in type, push button gasket IP65	ABW	2-pole, push button, 1pole overload protection, flat connection, flange type, push button gasket IP65	AHU
2-pole, push button, 2p overload protection, shunt terminal, flat connection, snap-in type, push button gasket IP65	ABX	2-pole, push button, 1pole overload protection, shunt terminal, flat connection, flange type, push button gasket IP65	AHV
2-pole, push button, 1pole overload protection, screw connection, snap-in type, push button gasket IP40	AEL	2-pole, push button, 2pole overload protection, flat connection, flange type, push button gasket IP65	AHW
2-pole, push button, 1p overload protection, shunt terminal, screw connection, snap-in type, push button gasket IP40	AEM	2-pole, push button, 2p overload protection, shunt terminal, flat connection, flange type, push button gasket IP65	AHX
2-pole, push button, 2pole overload protection, screw connection, snap-in type, push button gasket IP40	AEN	2-pole, push button, 1pole overload protection, screw connection, flange type, push button gasket IP40	AJL
2-pole, push button, 2p overload protection, shunt terminal, screw connection, snap-in type, push button gasket IP40	AEP	2-pole, push button, 1p overload protection, shunt terminal, screw connection, flange type, push button gasket IP40	AJM
2-pole, push button, 1pole overload protection, screw connection, snap-in type, push button gasket IP65	AEU	2-pole, push button, 2pole overload protection, screw connection, flange type, push button gasket IP40	AJN
2-pole, push button, 1p overload protection, shunt terminal, screw connection, snap-in type, push button gasket IP65	AEV	2-pole, push button, 2p overload protection, shunt terminal, screw connection, flange type, push button gasket IP40	AJP
		2-pole, push button, 1pole overload protection, screw connection, flange type, push button gasket IP65	AJU

Basic function	Configuration key
2-pole, push button, 1p overload protection, shunt terminal, screw connection, flange type, push button gasket IP65	AJV
2-pole, push button, 2pole overload protection, screw connection, flange type, push button gasket IP65	AJW
2-pole, push button, 2p overload protection, shunt terminal, screw connection, flange type, push button gasket IP65	AJX

TA45 - AK2 **W** F 120 A2 - AZM11 = Actuator colour

Actuator colour	Configuration key
Front Black: Green/Red	T
Front Yellow: Green/Red	U
Front Grey: Green/Red	V

TA45 - AK2 **W** F 120 A2 - AZM11 = Legend

Legend	Configuration key
embossed 	F
white printed 	H
black printed 	K
white printed 	L
black printed 	M
white printed 	P
black printed 	R
white printed 	S
black printed 	T

TA45 - AK2 **W** F 120 A2 - AZM11 = Rated current

Rated current	Configuration key
0.05 A	Z05
0.1 A	J01
0.2 A	J02
0.3 A	J03
0.4 A	J04
0.5 A	J05
0.6 A	J06
0.7 A	J07
0.8 A	J08
0.9 A	J09

Other rated currents on request

Rated current	Configuration key
1.0 A	J10
1.1 A	J11
1.2 A	J12
1.3 A	J13
1.4 A	J14
1.5 A	J15
1.6 A	J16
1.7 A	J17
1.8 A	J18
1.9 A	J19
2.0 A	J20
2.1 A	J21
2.2 A	J22
2.3 A	J23
2.5 A	J25
2.8 A	J28
3.0 A	030
3.5 A	035
4.0 A	040
4.5 A	045
5.0 A	050
6.0 A	060
6.5 A	065
7.0 A	070
7.5 A	075
8.0 A	080
9.0 A	090
10.0 A	100
11.0 A	110
12.0 A	120
13.0 A	130
14.0 A	140
15.0 A	150
16.0 A	160
17.0 A	170
18.0 A	180
19.0 A	190
20.0 A	200

Other rated currents on request

TA45 - AK2 **W** F 120 A2 - AZM11 = Release / lock-out latch

Release / lock-out latch	Configuration key
Remote trip release, rated voltage 240 V AC	A2
Remote trip release, rated voltage 230 V AC	A3
Remote trip release, rated voltage 120 V AC	A4
Remote trip release, rated voltage 48 V AC / DC	A6
Remote trip release, rated voltage 24 V AC / DC	A7
Remote trip release, rated voltage 12 V AC / DC	A8
whithout release / lock-out latch	C0
Undervoltage release with additional contact, rated voltage 240 V AC	E2
Undervoltage release with additional contact, rated voltage 230 V AC	E3
Undervoltage release with additional contact, rated voltage 120 V AC	E4

Release / lock-out latch	Configuration key	Release / lock-out latch	Configuration key
Undervoltage release with additional contact, rated voltage 48 V AC / DC	E6	Undervoltage release with 2 additional contacts, rated voltage 120 V AC	Z4
Undervoltage release with additional contact, rated voltage 24 V AC / DC	E7	Undervoltage release with 2 additional contacts, rated voltage 48 V AC / DC	Z6
Undervoltage release with additional contact, rated voltage 12 V AC / DC	E8	Undervoltage release with 2 additional contacts, rated voltage 24 V AC / DC	Z7
Undervoltage release with additional contact, rated voltage 5 V AC / DC	E9	Undervoltage release with 2 additional contacts, rated voltage 12 V AC / DC	Z8
Mechanical lock-out latch	S0	Undervoltage release with 2 additional contacts, rated voltage 5 V AC / DC	Z9
Undervoltage release, rated voltage 240 V AC	U2		
Undervoltage release, rated voltage 230 V AC	U3		
Undervoltage release, rated voltage 120 V AC	U4		
Undervoltage release, rated voltage 48 V AC / DC	U6		
Undervoltage release, rated voltage 24 V AC / DC	U7		
Undervoltage release, rated voltage 12 V AC / DC	U8		
Undervoltage release, rated voltage 5 V AC / DC	U9		
Undervoltage release with 2 additional contacts, rated voltage 240 V AC	Z2		
Undervoltage release with 2 additional contacts, rated voltage 230 V AC	Z3		

TA45 - AK2 W F 120 A2 - AZM11 = Accessories

Factory mounted accessories	Configuration key
Without cover	

For subsequent fitting accessories see:
http://www.schurter.com/pdf/english/typ_TA45-ACC.pdf

Variants

Thermal overload protection	Addition	connection type	Mounting	IP Protection Class Front Side	Actuator colour	Legend	Rated current	Accessories	Config. Code	Order Number
2-pole		Quick connect terminal	Snap-in type	IP40	Front Black: Green/Red	white printed	16.0 A	Without cover	TA45-ABNTL160U3	4430.3602
1-pole		Quick connect terminal	Snap-in type	IP65	Front Black: Green/Red	embossed	16.0 A	Without cover	TA45-ABUTF160E3	4430.3793

Availability for all products can be searched real-time: <https://www.schurter.com/en/Stock-Check/Stock-Check-SCHURTER>

Packaging Unit 1 Pcs

Accessories



Mouser Electronics

Authorized Distributor

Click to View Pricing, Inventory, Delivery & Lifecycle Information:

Schurter:

[4430.0964](#) [4430.1916](#) [4430.2686](#) [4430.2715](#) [4430.2724](#) [4430.2808](#) [4430.3008](#) [4430.3652](#) [4430.0500](#) [4430.1050](#)