



深圳市钜硕电子有限公司
钜硕电子 SHENZHEN JUSHUO ELECTRONICS CO., LTD

承认书

SPECIFICATIONS FOR APPROVAL

客 户:

CUSTOMER:

品 名:

DESCRIPTION:

FPC连接器1.0m间距抽拉卧式上接H2.5

料 号:

PART NO:

AFA07-S**ECA-00

承 认 印 ACKNOWLEDGMENT SEAL				
客 户 确 认 CUSTOMER APPROVAL		本 司 确 认 TRX APPROVAL		
核 准 APPROVAL		核 准 APPROVAL	贺 文 超	
工 程 PROJECT		工 程 PROJECT	吴 佩 隽	
品 保 Q A		品 保 Q A	王 成 铎	

◎ 联 系 人: 幸坤新

CONTACT PERSON

◎ 公 司 电 话: 0755-27220896

COMPANY TELEGRAMS

◎ 公 司 地 址: 广东省深圳市松岗镇下山门钜硕工业园

COMPANY ADDRESS

◎ 公 司 官 网: <http://www.jushuo.net.cn>

COMPANY WEBSITE

◎ 手 机: 13723739518

MOBILE PHONE

◎ 邮 箱: jushuo518@163.com

E-MAIL

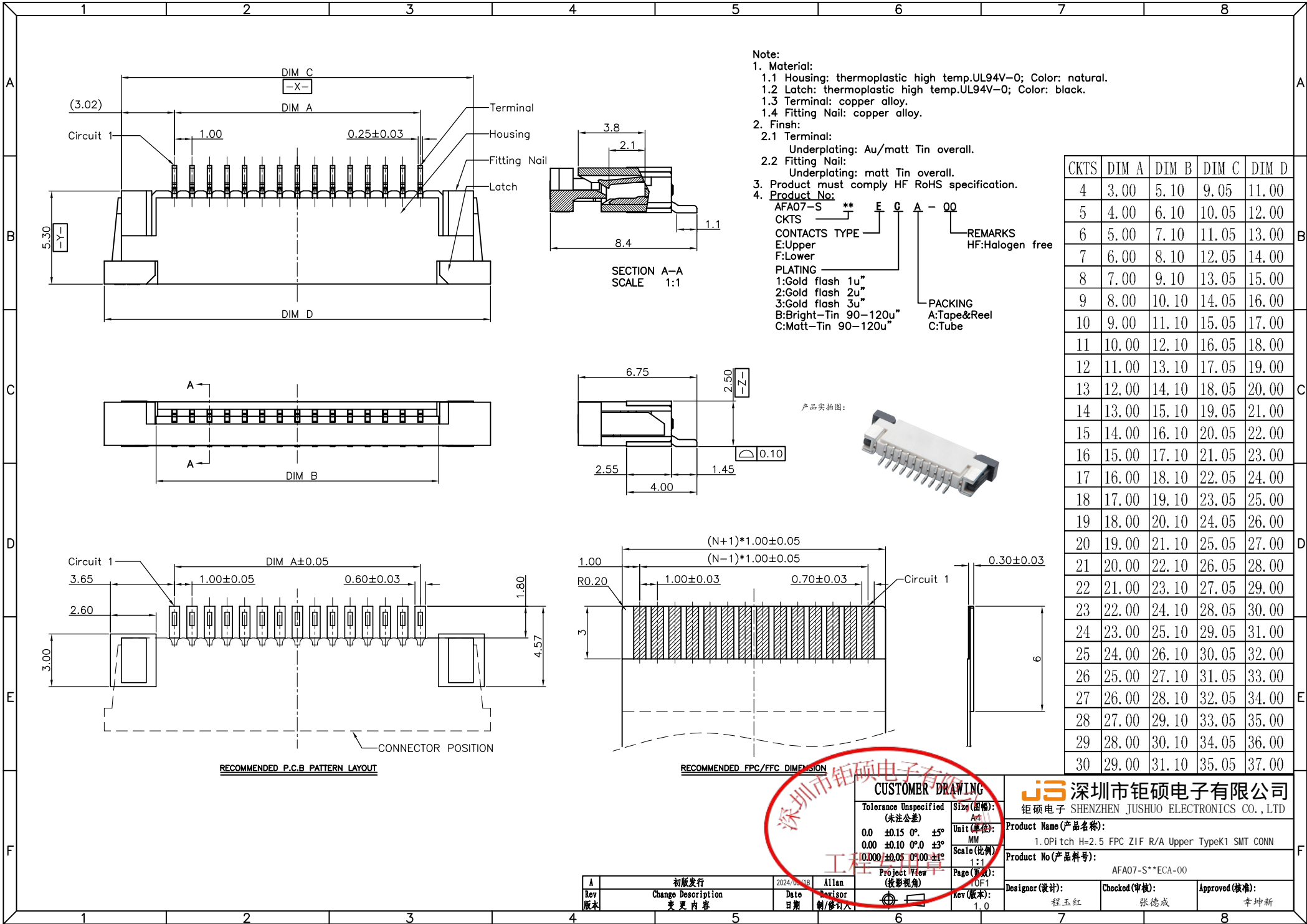

Note:
 1. Material:
 1.1 Housing: thermoplastic high temp.UL94V-0; Color: natural.
 1.2 Latch: thermoplastic high temp.UL94V-0; Color: black.
 1.3 Terminal: copper alloy.
 1.4 Fitting Nail: copper alloy.
 2. Finish:
 2.1 Terminal:
 Underplating: Au/matt Tin overall.
 2.2 Fitting Nail:
 Underplating: matt Tin overall.
 3. Product must comply HF RoHS specification.
 4. Product No:

AFA07-S ** E C A - 00
 CKTS
 CONTACTS TYPE
 E:Upper
 F:Lower
 PLATING
 1:Gold flash 1u"
 2:Gold flash 2u"
 3:Gold flash 3u"
 B:Bright-Tin 90-120u"
 C:Matt-Tin 90-120u"
 REMARKS
 HF:Halogen free
 PACKING
 A:Tape&Reel
 C:Tube

CKTS	DIM A	DIM B	DIM C	DIM D
4	3.00	5.10	9.05	11.00
5	4.00	6.10	10.05	12.00
6	5.00	7.10	11.05	13.00
7	6.00	8.10	12.05	14.00
8	7.00	9.10	13.05	15.00
9	8.00	10.10	14.05	16.00
10	9.00	11.10	15.05	17.00
11	10.00	12.10	16.05	18.00
12	11.00	13.10	17.05	19.00
13	12.00	14.10	18.05	20.00
14	13.00	15.10	19.05	21.00
15	14.00	16.10	20.05	22.00
16	15.00	17.10	21.05	23.00
17	16.00	18.10	22.05	24.00
18	17.00	19.10	23.05	25.00
19	18.00	20.10	24.05	26.00
20	19.00	21.10	25.05	27.00
21	20.00	22.10	26.05	28.00
22	21.00	23.10	27.05	29.00
23	22.00	24.10	28.05	30.00
24	23.00	25.10	29.05	31.00
25	24.00	26.10	30.05	32.00
26	25.00	27.10	31.05	33.00
27	26.00	28.10	32.05	34.00
28	27.00	29.10	33.05	35.00
29	28.00	30.10	34.05	36.00
30	29.00	31.10	35.05	37.00

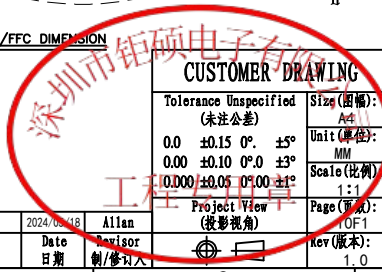

CUSTOMER DRAWING
 Tolerance Unspecified (未注公差)
 0.0 ±0.15 0° ±5°
 0.00 ±0.10 0°0 ±3°
 0.000 ±0.05 0°00 ±1°
 Project View (投影视图)

深圳市钜硕电子有限公司
 钜硕电子 SHENZHEN JUSHUO ELECTRONICS CO., LTD
 Product Name (产品名称):
 1.0Pitch H=2.5 FPC ZIF R/A Upper TypeK1 SMT CONN
 Product No(产品料号):
 AFA07-S**ECA-00
 Designer(设计): 程玉红
 Checked(审核): 张德成
 Approved(核准): 幸坤新

Rev	Change Description	Date	Author	Check
1	初版发行	2024/02/18	Allan	
Rev	变更内容	日期	制/修/入	

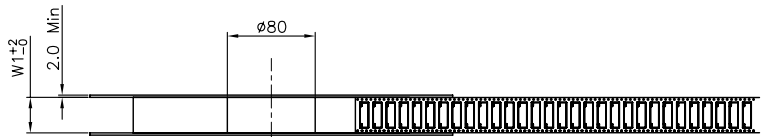

NOTES:

1. 10 SPROCKET HOLE PITCH CUMULATIVE TOLERANCE. $\pm 0.20\text{mm}$
2. CARRIER CAMBER NOT TO EXCEED 1mm IN 250mm.
3. ALL DIMENSIONS MEET EIA-481-C REQUIREMENTS.
4. MATERIAL: BLACK ANTI-STATIC POLYSTYRENE.
5. THICKNESS: $0.35 \pm 0.05\text{mm}$.
6. PACKING LENGTH PER 13" REEL : 18.60 METERS.
7. COMPONENT LOAD PER 13" REEL : 1500PCS
8. PEELING OFF FORCE OF TOP TAPE 0.1N~0.7N(10.2gf~100gf).

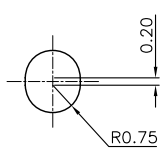
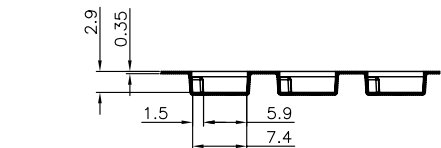
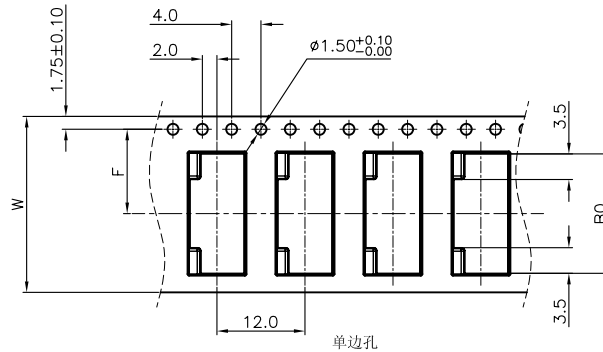
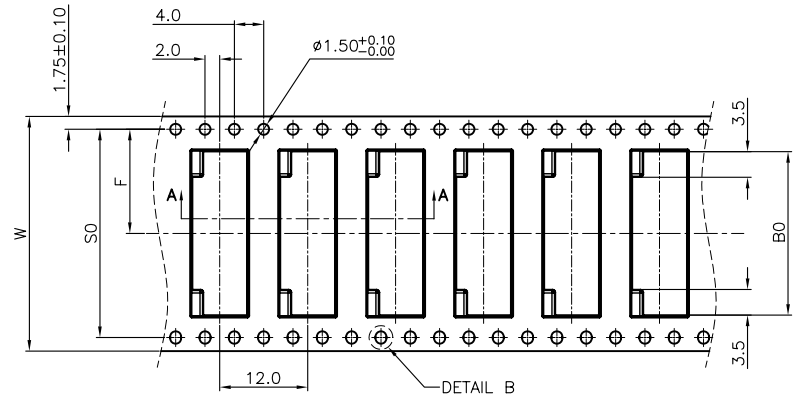
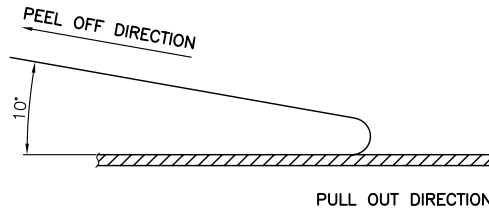
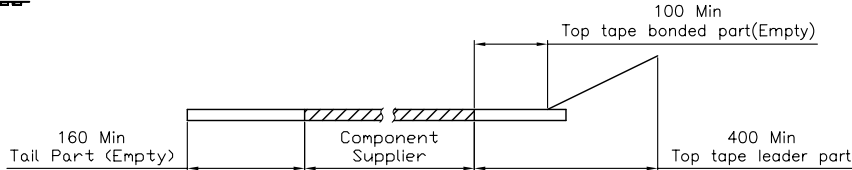
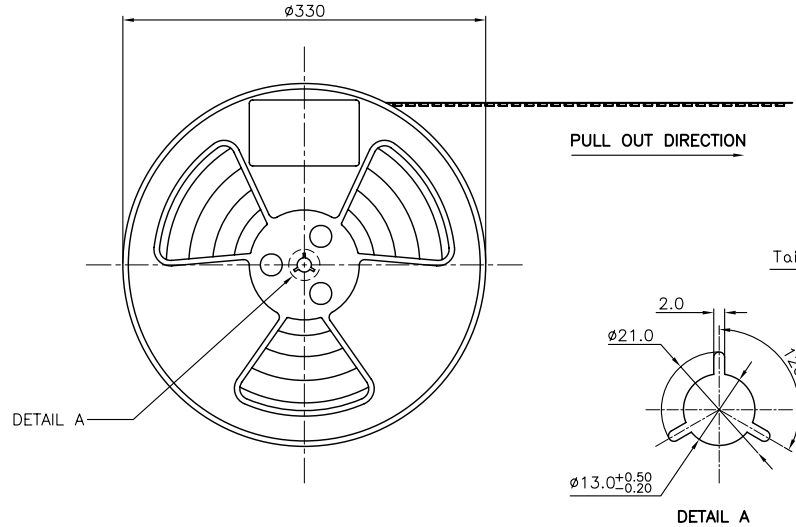

包装实拍图:



CKTS	B0±0.10	W	W1	F	S0±0.10
4	11.30	24±0.3/-0	24.4	11.5±0.10	单边孔
5	12.30				
6	13.30				
7	14.30				
8	15.30	32±0.30	32.4	14.2±0.10	28.4
9	16.30				
10	17.30				
11	18.30				
12	19.30	44±0.30	44.4	20.2±0.15	40.4
13	20.30				
14	21.30				
15	22.30				
16	23.30	56±0.30	56.4	26.2±0.15	52.4
17	24.30				
18	25.30				
19	26.30				
20	27.30	66±0.30	66.4	32.2±0.15	58.4
21	28.30				
22	29.30				
23	30.30				
24	31.30	78±0.30	78.4	38.2±0.15	64.4
25	32.30				
26	33.30				
27	34.30				
28	35.30	90±0.30	90.4	44.2±0.15	70.4
29	36.30				
30	37.30				

CLASSIFICATION DIMENSION (尺寸类别):
 (未注公差) (未注公差) (未注公差)
 *MARK IS MAJOR DIM (重要尺寸标示)
 *MARK IS CRITICAL DIM (关键尺寸标示)

Tolerance (公差):
 (未注公差) ±0.10 0° ±3°
 0.00 ±0.05 0.00 ±0.02 0.00 ±0.02

Size (规格):
 A4
 MM
 Scale (比例):
 1:1

Project View (投影视图):
 10 OF 10

Page (页数):
 10 OF 10

Rev (版本):
 1.0

J3 深圳市钜硕电子有限公司
 钜硕电子 SHENZHEN JUSHUO ELECTRONICS CO., LTD

Product Name (产品名称):
 1.0Pitch H=2.5 FPC 拉拔卧式K型. 载带

Product No (产品料号):
 AFA07-S**ECA-00

Drawing No (图面编号):
 DNE00015-1

Date (日期):
 2024/05/18

Designer (设计):
 程玉红

Checked (审核):
 张德成

Approved (核准):
 幸坤新

Rev 版本	Date 日期	Revisor 制/修订人
1.0	2024/05/18	初版发行
		变更内容

产 品 规 格 书

PRODUCT SPECIFICATION

【1】适用范围 SCOPE

本规格书适用于：1.0mm间距柔性扁平电缆连接器（有锁式）

This specification covers the 1.0mm Pitch FPC/FFC Connectors (series Locking)

【2】产品名称及型号 PRODUCT NAME AND PART NUMBER

产品名称 Product Name	产品型号 Part Number
FPC/FFC 扁平电缆连接器	AFA07-S**ECA-00

【3】定格 RATINGS

项目 Item	规 格	Requirement
最大容许电压 Rated Voltage(MAX)	50V	[AC/DC(有效值 Virtual value)50Hz]
最大容许电流 Rated Current(MAX)	0.5A	
使用温度范围 Ambient temperature Range	-45℃ ~ +85℃	

【4】性能 PERFORMANCE

4.1 电气性能 Electrical Performance

项目 Item		条件 Test Condition	规格 Requirement
4.1.1	接触电阻 Contact Resistance	适合 FPC/FFC 嵌合；开放电压 20mV 以下；短路电流 10mA 的状态下测定。 Mate applicable FPC/FFC and measure by dry circuit, 20mV MAX, 10mA.	≤20 m Ω MAX
4.1.2	绝缘电阻 Insulation Resistance	适合 FPC/FFC 嵌合；相邻端子间或端子与地面间加 DC 500V 下测定。 Mate applicable FPC/FFC and apply 500V DC between adjacent terminal or ground.	500M Ω MIN
4.1.3	耐电压 Dielectric	适合 FPC/FFC 嵌合；相邻端子间或端子与地面间加 AC 200V（有效值）历时 1 分钟下测定。 Mate applicable FPC/FFC and apply 200V AC (virtual value) for 1minute between adjacent terminal or ground.	无击穿现象 No Breakdown

4.2 机械性能 Mechanical Performance

项目 Item		条件 Test Condition	规格 Requirement
4.2.1	锁紧力及拔出力 Locking and Withdrawal Force	适合 0.3mm 厚的 FFC；用每分钟 25±3mm 的速度；平行地插入、锁紧、拔出。 Insert and extract applicable FFC at the speed rate of 25±3mm/minute.	锁紧力 Locking 1.96*n (N) MAX 拔出力 Withdrawal 0.49*n (N) MIN
4.2.2	端子保持力 Terminal /Housing Retention Force	以用每分钟 25±3mm 的速度平行向外拉 Pull the terminal at the speed rate of 25±3mm per minute	3.92N MIN

4.3 环境和其他性能 Environmental Performance and Others

项目 Item		条件 Test Condition	规格 Requirement	
4.3.1	重复插拔 Repeated Insertion and Withdrawal	无通电状态；以 10 次/分钟的速度插拔 20 次 Insertion and withdrawal actuator up to 20 cycles at the speed rate of less than 10 cycles/minute	接触抵抗 Contact Resistance	60 m Ω MAX
4.3.2	温度上升 Temperature Rise	适合 FPC/FFC 嵌合；最大容许电流通电，温度测定。（UL 498） Carrying rated current load. (UL 498)	温度上升 Temperature Rise	30 °C MAX

项目 Item		条件 Test Condition	规格 Requirement	
4.3.3	耐振动性 Vibration	DC 1mA 通电状态下; 嵌合轴沿 XYZ 三个方向振动; 振幅 1.5mm; 频率 10-55-10Hz/分; 历时 2 小时 Amplitude: 1.5mm P-P Sweep time: 10-55-10Hz in 1 minute Duration: 2 hours in each X.Y.Z. axes	外观 Appearance	无损坏 No Damage
			接触抵抗 Contact Resistance	60 m Ω MAX
			瞬断 Discontinuity	1 ms MAX.
4.3.4	耐冲击性 Shock	DC 1mA 通电状态下; 嵌合轴沿相互垂直的 6 个方向; 以 490m/s ² {50G}冲击; 各 3 次 490m/s ² {50G}, 3 strokes in each X.Y.Z. axes.	外观 Appearance	无损坏 No Damage
			瞬断 Discontinuity	1 ms MAX.
4.3.5	耐热性 Heat Resistance	适合 FPC/FFC 嵌合; 85±2℃的空气中; 放置 96 小时; 再回到室温中放置 1-2 小时 85±2℃, 96 hour	外观 Appearance	无损坏 No Damage
			接触抵抗 Contact Resistance	60 m Ω MAX
4.3.6	耐寒性 Cold Resistance	适合 FPC/FFC 嵌合; -40±2℃的空气中; 放置 96 小时; 再回到室温中放置 1-2 小时 -40±2℃, 96 hour	外观 Appearance	无损坏 No Damage
			接触抵抗 Contact Resistance	60 m Ω MAX
4.3.7	耐湿性 Humidity	适合 FPC/FFC 嵌合; 40±2℃、相对湿度 90-95%的空气中; 放置 96 小时; 再回到室温中 0.5 小时内测定 Temperature: 40±2℃ Relative Humidity: 90-95% Duration: 96 Hours	外观 Appearance	无损坏 No Damage
			接触抵抗 Contact Resistance	60 m Ω MAX
			耐电压 Dielectric Strength	必须满足 4.1.3 Must meet 4.1.3
			绝缘抵抗 Insulation Resistance	20 M Ω MIN
4.3.8	温度循环 Temperature Cycling	适合 FPC/FFC 嵌合; -45±2℃ 30 分钟; 常温常湿 10-15 分钟; 85±2℃ 30 分钟; 常温常湿 10-15 分钟, 循环 5 次。 5 cycles of: a) -45±2℃ 30 minutes b) 85±2℃ 30 minutes	外观 Appearance	无损坏 No Damage
			接触抵抗 Contact Resistance	60 m Ω MAX

项目 Item		条件 Test Condition	规格 Requirement	
4.3.9	耐盐雾性 Salt Spray	适合 FPC/FFC 嵌合; 35±2℃、5±1% 的盐水喷雾 48 小时; 试验后常温水洗; 再室温干燥。 48±4 hours exposure to a salt spray from the 5±1% solution at 35±2℃.	外观 Appearance	无损坏、腐蚀 No Damage
			接触抵抗 Contact Resistance	60 m Ω MAX
4.3.10	耐亚硫酸 SO2 Gas	适合 FPC/FFC 嵌合; 40±2℃、50±5ppm 的亚硫酸中放置 24 小时 24 hours exposure to 50±5ppm. SO2 gas at 40±2℃.	接触抵抗 Contact Resistance	60 m Ω MAX
4.3.11	耐氨性 NH3 Gas	适合 FPC/FFC 嵌合; 浓度为 28% 的氨水容器中; 放置 40 分钟。 40 minutes exposure to NH3 gas evaporating from 28% Ammonia solution	外观 Appearance	无损坏 No Damage
			接触抵抗 Contact Resistance	60 m Ω MAX
4.3.12	可焊性 Solder ability	端子前端基准面 0.2mm 处浸入 235±5℃ 的锡槽中; 历时 2±0.5 sec。 Soldering Time: 2±0.5 sec. Soldering Temperature: 235±5℃ 0.2 mm from terminal tip	沾敷性 Solder Wetting	沾敷面积 95% 以上
4.3.13	耐焊接热 Resistance to Soldering heat	端子前端基准面 0.2mm 处浸入 260±5℃ 的锡槽中; 历时 5±0.5 sec。 Soldering Time: 5±0.5 sec. Soldering Temperature: 260±5℃ 0.2 mm from terminal tip	外观 Appearance	无损坏、变形 No Damage

() : 参考规格 Reference Standard

{ } : 参考单位 Reference Unit

【5】外观形状、寸法及材质 PRODUCT SHAPE, DIMENSIONS AND MATERIALS

图面参照 Refer to the drawing.

名称 NAME	材质 MATERIALS
主体 Main body	LCP(本色) UL 94V-0
锁扣 Housing Lock	LCP(黑色) UL 94V-0
端子 Sit uip	磷青铜 Phosphor Bronze
焊片 Contact	磷青铜 Phosphor Bronze
备注 Remark	金属表面镀金/镀锡 Metal Gold Plated/Tinning



公司名称: 深圳市钜硕电子有限公司
炉子名称: 6635

地点: 深圳市宝安区松岗街道广深路480号
制程界限名称: System Default for Reflow

温度设置 (摄氏度)

温区	1	2	3	4	5	6
上温区	180	190	200	230	250	265
下温区	180	190	200	230	250	265

传送带速度 (英寸/分): 40.0

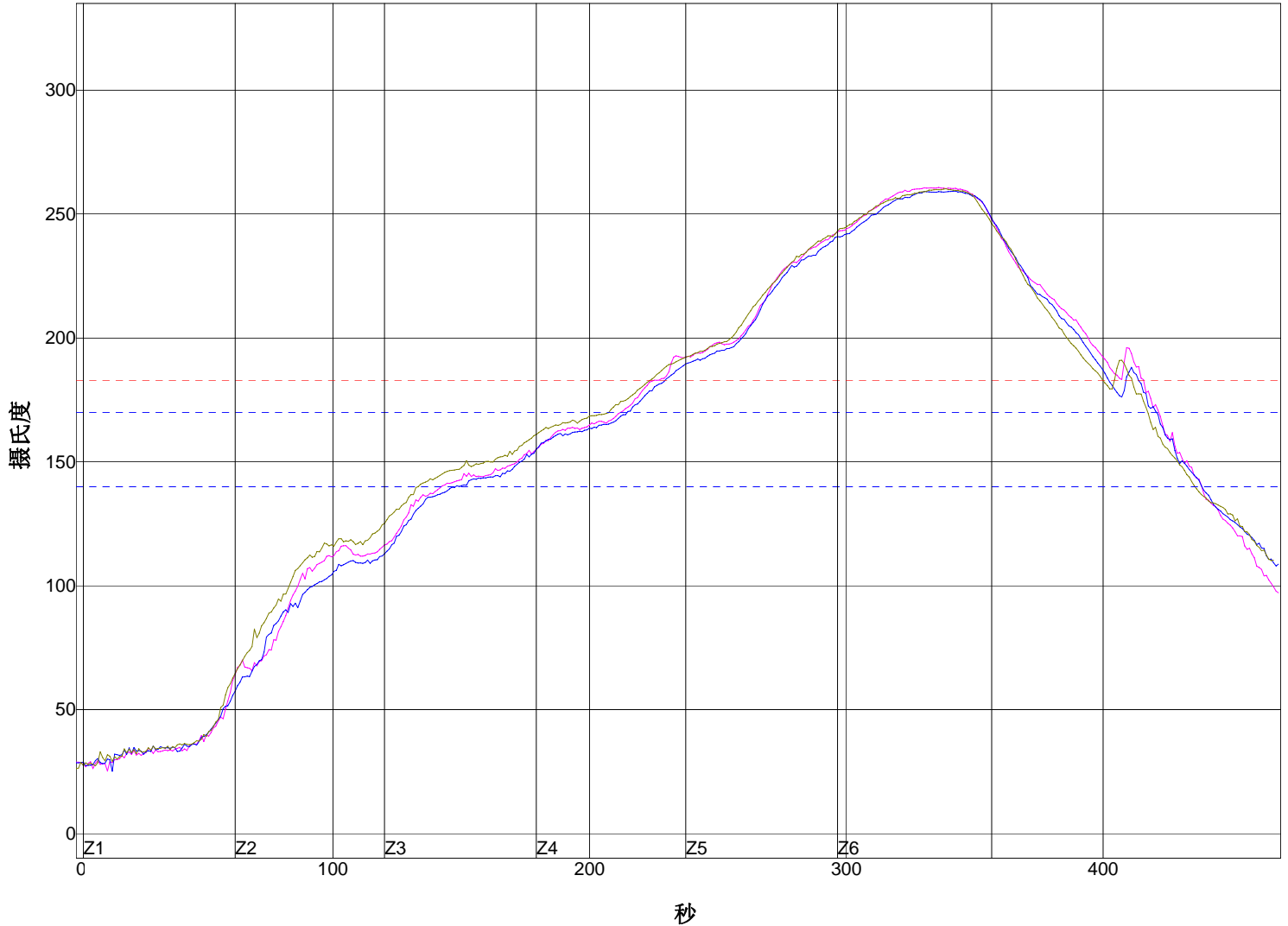

PWI= 458%	最高上升斜率		恒温时间140至170C		回流时间 /183C		最高温度	
<TC2>	1.85	23%	69.43	-3%	190.00	433%	260.78	458%
<TC3>	1.66	11%	65.91	-20%	177.80	393%	259.31	443%
<TC4>	2.02	34%	73.66	18%	183.16	411%	260.34	453%
温差	0.36		7.75		12.20		1.47	

制程界限:

锡膏: System Default for Reflow			
统计数名称	最低界限	最高界限	单位
最高温度上升斜率 (目标=1.5) (计算斜率的时间距离= 30 秒)	0	3	度/秒
恒温时间140-170摄氏度	50	90	秒
回流以上时间 - 183摄氏度	30	90	秒
最高温度	205	225	度 摄氏度

描述:



QC工程图

产品描述: FPC&WAFER连接器系列	产品料号: 适用于所有 FPC&WAFER连接器系列	版本: A	编号及版本: JS-SIP-0075-01	制定日期: 2024/05/18
----------------------	----------------------------	-------	-----------------------	------------------

作业流程	作业过程描述	控制要点/参数/条件	检验频率	作业者/检验者	管制界限值	检测方法	级判定	处理方式
	开始							
	进料检验	原材料、零部件料号、规格	MIL-STD-105E	IQC	依工程图/SOP/SIP	目视/送实验室检测	2&3	允收/退货/挑选/特采
	投入物料	原材料、零部件料号、规格	每批物料	线长/IPQC	生产任务单/BOM	目视/送实验室检测	1	退货
	冲压/成型生产	尺寸/外观/功能/装配等	抽检/自检 2模/1H	作业员/IPQC	依工程图/SOP/SIP	目视/测试/测量/装配	1	标示隔离/重工/报废
	外观	外观/尺寸/功能	全检 两模/1H	作业员/IPQC	依工程图/SOP/SIP	目视/测量	1	标示隔离/重工
	包装入库	标示日期/班次/小心运输	袋 /每批	作业员/IPQC	入库单	目视	1	调整
	投入物料	零部件料号/规格	每批物料	线长/IPQC	生产任务单/BOM	目视/送实验室检测	1	退货/挑选/特采
	裁切端子	端子无变形/氧化等	自检	作业员	作业指导书	目视	0	调整
	自动机插端/手工插端	端子无变形/铆合尺寸/折料带端子无变形	2模/1H	作业员/IPQC	依工程图/SOP/SIP	目视/测量	1	调机
	装配塑胶	装配到位/无缺料/毛边/堵孔/断裂/混料/错位/保持力	2模/1H	作业员/IPQC	依工程图/SOP/SIP	目视/送实验室检测	1	标示隔离/重工/报废
	装配焊片	装配到位/毛边/堵孔/断裂/混料/脱落	2模/1H	作业员/IPQC	依工程图/SOP/SIP	目视/送实验室检测	1	标示隔离/重工/报废

核准: 幸坤新

审核: 刘朋飞

制订: 陈艳

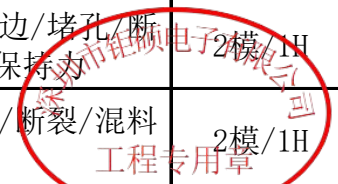

QC工程图

产品描述: FPC&WAFER连接器系列	产品料号: 适用于所有 FPC&WAFER连接器系列	版本: A	编号及版本: JS-SIP-0075-02	制定日期: 2024/05/18
----------------------	----------------------------	-------	-----------------------	------------------

作业流程	作业过程描述	控制要点/参数/条件	检验频率	作业者/检验者	管制界限值	检测方法	判定级别	处理方式
	初检	无缺料/毛边/堵孔/色差/高低针/混料/斜针/缺针/电镀不良等	全检	FQC	作业指导书	目视/测量	0	标示隔离/重工
								
	入管	无混料/少数/多装等	自检	作业员	作业指导书	目视	0	重工
								
	总检	无缺料/毛边/堵孔/色差/高低针/混料/斜针/缺针/电镀不良等	全检	FQC	作业指导书	目视/测量	0	标示隔离/重工
								
	OQC抽检	无缺料/毛边/堵孔/色差/高低针/混料/斜针/缺针/电镀不良等	抽检	OQC	SIP/SOP/MIL-STD-105E II	目视/测量	0	标示隔离/重工
								
	包装入库	分清每批日期/搬运/轻放	每批	作业员	入库单	目视	0	调整
								
	出货检验	合格标签内容/出货内容	每批	OQC	作业指导书	目视	1	标示隔离/重工
								
	完成							



备注: 1. 每次开始生产调机及换料后必须进行首件检验, 数量为两模。工程图面标示“▼”的尺寸全量测; 耐高温测试、焊锡性测试、功能测试等。
 2. 插入力、拔出力及保持力请参见工程图及规格书

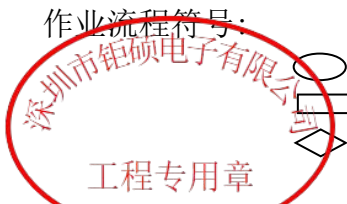

判定级别:

- 0. 作业员自检
- 1. 线长/IPQC/IPQC线长
- 2. 工程师/课长/经理
- 3. 副总/总经理

作业流程符号:



-  开始/终止
-  作业
-  检验/测试

-  物料投入
-  存储

核准: 幸坤新

审核: 刘朋飞

制订: 陈艳