

1	2	3	4	5	6	7	8				
				IPX7 1m/30min	ROHS	REV A1	ECN NO NEW	DESCRIPTION Replace frame	DESIGN	APPROVAL	DATE 2018.06.12

NOTES

- CURRENT RATING: 1A.
- CONTACT RESISTANCE: 100mΩ MAX.
- INSULATION RESISTANCE: 100MΩ MIN.
- DIELECTRIC WITHSTANDING: 500V AC MIN.
- DURABILITY: 5000 CYCLES MIN.
- CONNECTOR MATING FORCES: 3~30N.
- CONNECTOR UNMATING FORCES: 3~30NX.
- SALT SPRAY: 24HOUR
- WATERPROOF LEVEL: IP67.
- OPERATING TEMPERATURE: -25°C TO +85°C.

Not to install the waterproof ring shipment

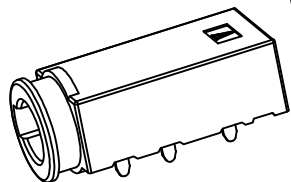

3D VIEW

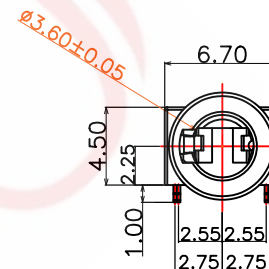
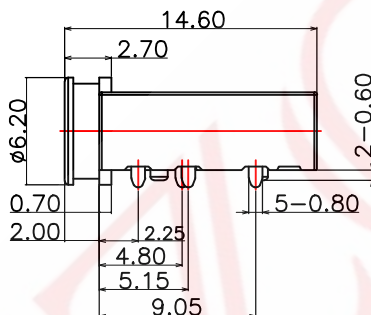
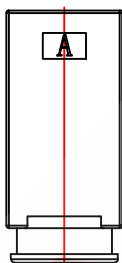

8 F W 5 1 4 6 A T A

MODEL DEFINITION

- Mould Number:01
- Fixing Method:Fixing Column
- Interface Method:Convention Extended Opening
- Overall Length:14.6mm
- Pin Position:5PIN
- Mounting Method:DIP
- Product Series: 3.5mm Audio Jack

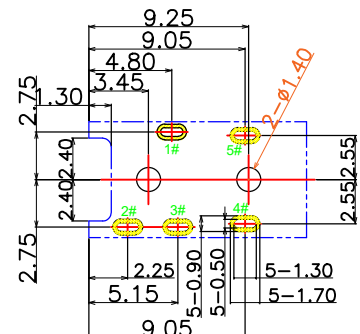
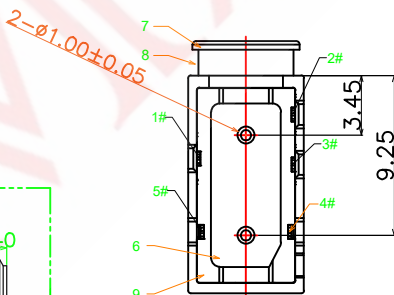
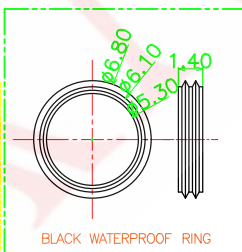
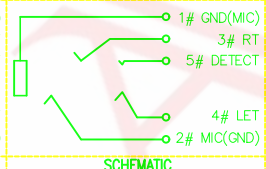
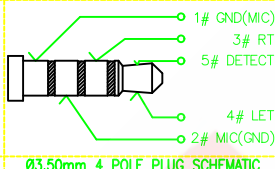
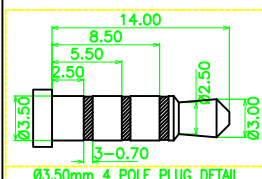

PCB LAYOUT (TOP VIEW)
TOLERANCE: ±0.05

ITEM	DESCRIPTION	MATERIAL	QTY	FINISH/COLOR				GENERAL TOLERANCE	
F	胶水	环氧树脂	1	黑色					
E	防水圈	硅胶	1	黑色			≥2~2<	±0.15	
D	底座	高温尼龙	1	黑色			≥2~5<	±0.25	
C	封盖	高温尼龙	1	黑色	DESIGN	WANGGUIFA	2018.06.12	≥2~5<	±0.25
B	引脚	磷青铜	2.3	镀镍/接触区焊位镀金	CHECKED	ZHENGUILAN	2018.06.12	≥0~2<	±0.15
A	引脚	不锈钢	1.4.5	镀镍/接触区焊位镀金	APPROVED	LILIANJIANG	2018.06.14	≥5	±0.35

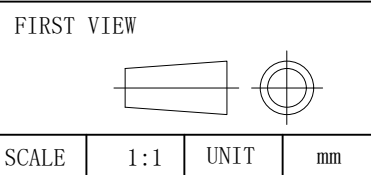

The copyright belongs to samzo parts [China] Co., Ltd. please use the material after samzo parts agree to authorize. The final right of interpretation belongs to samzo parts. WWW.KKK-JP.COM

TITLE: 3.5mm 5P DIP JCAK IPX7
DWG NO: 8FW5146-P04
PART NO: 8FW51461574
MODEL NO: 8FW5146ATA
NAME: WATERPROOF SOCKET

SAMZO COMPONENTS
Electronic switch and connector manufacturer

1	2	3	4	5	6	7	8
---	---	---	---	---	---	---	---