

## Spindle axes ELGA-BS

**FESTO**

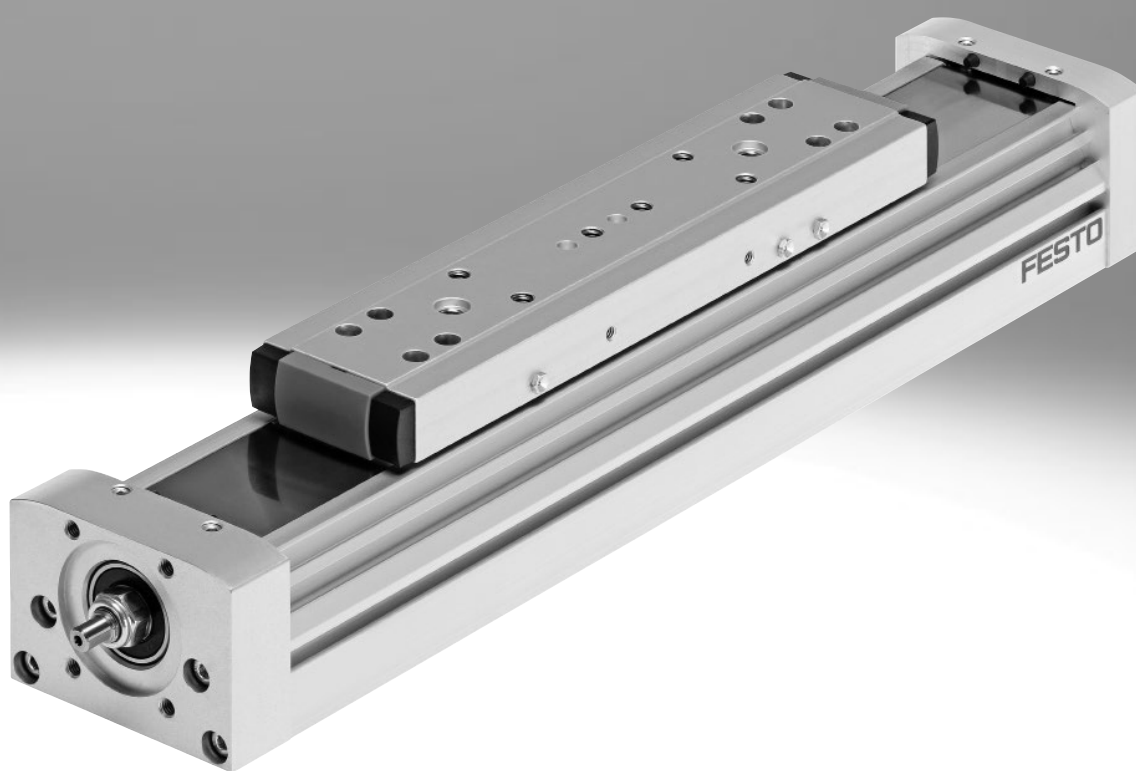

Selection aid

Overview of toothed belt and spindle axes

Toothed belt axes

- Speeds of up to 10 m/s
- Acceleration of up to 50 m/s<sup>2</sup>
- Repetition accuracy of up to ±0.08 mm
- Strokes of up to 8500 mm (longer strokes on request)
- Flexible motor mounting

Spindle axes

- Speeds of up to 2 m/s
- Acceleration of up to 20 m/s<sup>2</sup>
- Repetition accuracy of up to ±0.003 mm
- Strokes of up to 3000 mm

Coordinate system

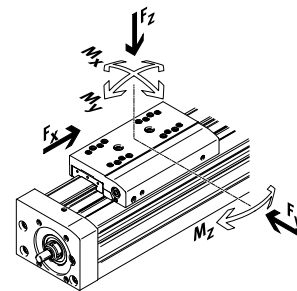

Toothed belt axes

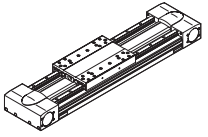
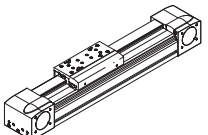
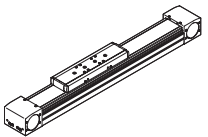
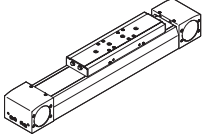
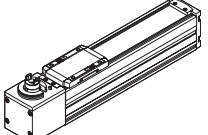
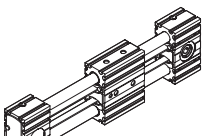
Type	F <sub>x</sub> [N]	v [m/s]	M <sub>x</sub> [Nm]	M <sub>y</sub> [Nm]	M <sub>z</sub> [Nm]	Characteristics
<b>Heavy-duty recirculating ball bearing guide</b>						
<b>EGC-HD-TB</b> 	450 1000 1800	3 5 5	140 300 900	275 500 1450	275 500 1450	<ul style="list-style-type: none"> <li>• Flat drive unit with rigid, closed profile</li> <li>• Precision DUO guide rail with high load capacity</li> <li>• Ideal as a base axis for linear gantries and cantilever axes</li> </ul>
<b>Recirculating ball bearing guide</b>						
<b>EGC-TB-KF</b> 	50 100 350 800 2500	3 5 5 5 5	3.5 16 36 144 529	10 132 228 680 1820	10 132 228 680 1820	<ul style="list-style-type: none"> <li>• Rigid, closed profile</li> <li>• Precision guide rail with high load capacity</li> <li>• Small drive pinions reduce required driving torque</li> <li>• Space-saving position sensing</li> </ul>
<b>ELGA-TB-KF</b> 	350 800 1300 2000	5 5 5 5	16 36 104 167	132 228 680 1150	132 228 680 1150	<ul style="list-style-type: none"> <li>• Internal guide and toothed belt</li> <li>• Precision guide rail with high load capacity</li> <li>• Guide and toothed belt protected by cover strip</li> <li>• High feed forces</li> </ul>
<b>ELGA-TB-KF-F1</b> 	260 600 1000	5 5 5	16 36 104	132 228 680	132 228 680	<ul style="list-style-type: none"> <li>• Suitable for use in the food zone</li> <li>• "Clean look": smooth, easy-to-clean surfaces</li> <li>• Internal guide and toothed belt</li> <li>• Precision guide rail with high load capacity</li> <li>• Guide and toothed belt protected by cover strip</li> </ul>
<b>ELGC-TB-KF</b> 	75 120 250	1.2 1.5 1.5	5.5 29.1 59.8	4.7 31.8 56.2	4.7 31.8 56.2	<ul style="list-style-type: none"> <li>• Internal guide and toothed belt</li> <li>• Precision guide rail with high load capacity</li> <li>• Guide and toothed belt protected by cover strip</li> </ul>
<b>ELGR-TB</b> 	50 100 350	3 3 3	2.5 5 15	20 40 124	20 40 124	<ul style="list-style-type: none"> <li>• Cost-optimised rod guide</li> <li>• Ready-to-install unit</li> <li>• Linear ball bearings with high load capacity for dynamic operation</li> </ul>

## Selection aid

## Overview of toothed belt and spindle axes

## Toothed belt axes

- Speeds of up to 10 m/s
- Acceleration of up to 50 m/s<sup>2</sup>
- Repetition accuracy of up to ±0.08 mm
- Strokes of up to 8500 mm (longer strokes on request)
- Flexible motor mounting

## Spindle axes

- Speeds of up to 2 m/s
- Acceleration of up to 20 m/s<sup>2</sup>
- Repetition accuracy of up to ±0.003 mm
- Strokes of up to 3000 mm

## Coordinate system

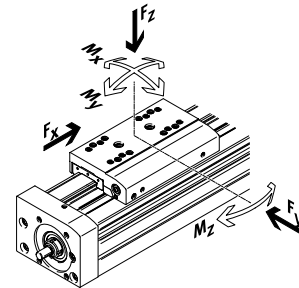

## Toothed belt axes

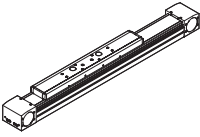
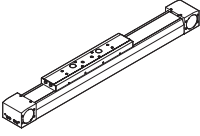
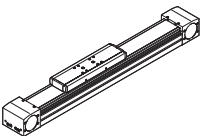
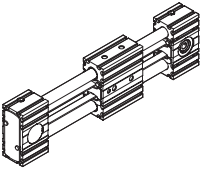
Type	$F_x$ [N]	$v$ [m/s]	$M_x$ [Nm]	$M_y$ [Nm]	$M_z$ [Nm]	Characteristics
<b>Roller bearing guide</b>						
<b>ELGA-TB-RF</b>						
	350 800 1300	10 10 10	11 30 100	40 180 640	40 180 640	<ul style="list-style-type: none"> <li>• Heavy-duty roller bearing guide</li> <li>• Guide and toothed belt protected by cover strip</li> <li>• Speeds of up to 10 m/s</li> <li>• Lower weight than axes with guide rails</li> </ul>
<b>ELGA-TB-RF-F1</b>						
	260 600 1000	10 10 10	8.8 24 80	32 144 512	32 144 512	<ul style="list-style-type: none"> <li>• Suitable for use in the food zone</li> <li>• "Clean look": smooth, easy-to-clean surfaces</li> <li>• Heavy-duty roller bearing guide</li> <li>• Guide and toothed belt protected by cover strip</li> <li>• Lower weight than axes with guide rails</li> </ul>
<b>Plain-bearing guide</b>						
<b>ELGA-TB-G</b>						
	350 800 1300	5 5 5	5 10 20	30 60 120	10 20 40	<ul style="list-style-type: none"> <li>• Guide and toothed belt protected by cover strip</li> <li>• For simple handling tasks</li> <li>• As a drive component for external guides</li> <li>• Insensitive to harsh ambient conditions</li> </ul>
<b>ELGR-TB-GF</b>						
	50 100 350	1 1 1	1 2.5 1	10 20 40	10 20 40	<ul style="list-style-type: none"> <li>• Cost-optimised rod guide</li> <li>• Ready-to-install unit</li> <li>• Heavy-duty plain bearings for use in harsh environmental conditions</li> </ul>

## Selection aid

### Overview of toothed belt and spindle axes

#### Toothed belt axes

- Speeds of up to 10 m/s
- Acceleration of up to 50 m/s<sup>2</sup>
- Repetition accuracy of up to ±0.08 mm
- Strokes of up to 8500 mm (longer strokes on request)
- Flexible motor mounting

#### Spindle axes

- Speeds of up to 2 m/s
- Acceleration of up to 20 m/s<sup>2</sup>
- Repetition accuracy of up to ±0.003 mm
- Strokes of up to 3000 mm

#### Coordinate system

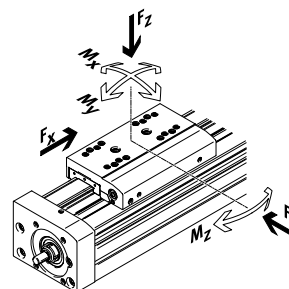

#### Spindle axes

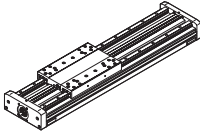
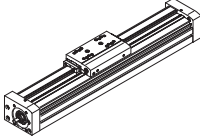
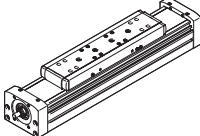
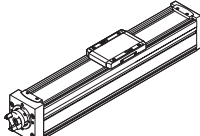
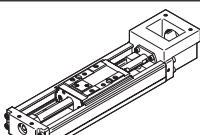
Type	F <sub>x</sub> [N]	v [m/s]	M <sub>x</sub> [Nm]	M <sub>y</sub> [Nm]	M <sub>z</sub> [Nm]	Characteristics
<b>Heavy-duty recirculating ball bearing guide</b>						
<b>EGC-HD-BS</b>						
	400 650 1500	0.5 1.0 1.5	140 300 900	275 500 1450	275 500 1450	<ul style="list-style-type: none"> <li>• Flat drive unit with rigid, closed profile</li> <li>• Precision DUO guide rail with high load capacity</li> <li>• Ideal as a base axis for linear gantries and cantilever axes</li> </ul>
<b>Recirculating ball bearing guide</b>						
<b>EGC-BS-KF</b>						
	400 650 1500 3000	0.5 1.0 1.5 2.0	16 36 144 529	132 228 680 1820	132 228 680 1820	<ul style="list-style-type: none"> <li>• Rigid, closed profile</li> <li>• Precision guide rail with high load capacity</li> <li>• For the highest requirements in terms of feed force and accuracy</li> <li>• Space-saving position sensing</li> </ul>
<b>ELGA-BS-KF</b>						
	650 1600 3400 6400	0.5 1.0 1.5 2.0	16 36 104 167	132 228 680 1150	132 228 680 1150	<ul style="list-style-type: none"> <li>• Internal guide and ball screw</li> <li>• Precision guide rail with high load capacity</li> <li>• For the highest requirements in terms of feed force and accuracy</li> <li>• Guide and ball screw protected by cover strip</li> <li>• Space-saving position sensing</li> </ul>
<b>ELGC-BS-KF</b>						
	40 100 200 350	0.6 0.6 0.8 1.0	1.3 5.5 29.1 59.8	1.1 4.7 31.8 56.2	1.1 4.7 31.8 56.2	<ul style="list-style-type: none"> <li>• Internal guide and ball screw</li> <li>• Guide and ball screw protected by cover strip</li> <li>• Space-saving position sensing</li> </ul>
<b>EGSK</b>						
	57 133 184 239 392	0.33 1.10 0.83 1.10 1.48	13 28.7 60 79.5 231	3.7 9.2 20.4 26 77.3	3.7 9.2 20.4 26 77.3	<ul style="list-style-type: none"> <li>• Spindle axes with maximum precision, compactness and rigidity</li> <li>• Recirculating ball bearing guide and ball screw without caged ball bearings</li> <li>• Standard designs in stock</li> </ul>

## Key features

### At a glance

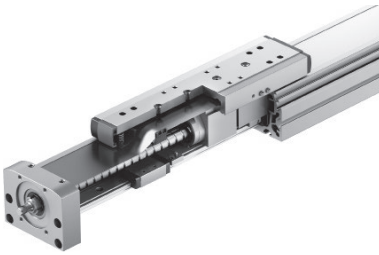

- Stainless steel cover strip with magnetic seal provides basic protection for guide and spindle. This also makes it possible to reduce particulate emissions for use in clean environments
- The optional magnetic reversal in the slide guides the stainless steel cover strip through the slide and back onto the profile. The magnets ensure there is no friction on the visible surface of the cover strip
- The magnetic belt reversal minimises particulate emissions for use in clean rooms
- Internal, precision recirculating ball bearing guide with high load capacity for high torque loads
- Easy maintenance thanks to easily accessible lubrication connections

### Displacement encoder (optional)

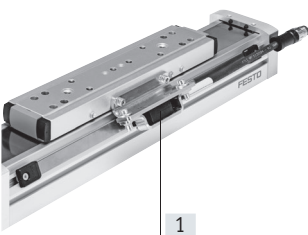

[1] Displacement encoder (optional)  
The position of the slide can be sensed directly when using the incremental displacement encoder. This means that all elasticities of the drive train can be detected and can be adjusted by the motor controller (→ page 13)

### Sealing air connections

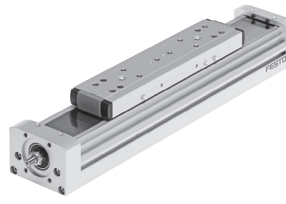

[1] Sealing air connections

- Application of negative pressure minimises the dispersal of abraded particles into the environment
- Application of gauge pressure prevents dirt from getting into the axis

### Characteristic values of the axes

The specifications shown in the table are maximum values.

The precise values for each of the variants can be found in the relevant data sheet in the catalogue.

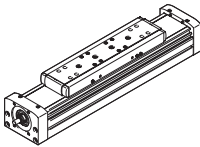
Design	Size	Working stroke [mm]	Speed [m/s]	Repetition accuracy [mm]	Max. feed force [N]	Guide characteristics				
						Forces and torques				
						F <sub>y</sub> [N]	F <sub>z</sub> [N]	M <sub>x</sub> [Nm]	M <sub>y</sub> [Nm]	M <sub>z</sub> [Nm]
<b>Recirculating ball bearing guide</b>										
	70	50 ... 900	0.5	±0.02	650	1500	1850	16	132	132
	80	50 ... 1940	1.0	±0.02	1600	2500	3050	36	228	228
	120	50 ... 2460	1.5	±0.02	3400	5500	6890	104	680	680
	150	50 ... 3000	2.0	±0.02	6400	5500	11000	167	1150	1150

### Note

Engineering software  
Electric Motion Sizing  
[www.festo.com/x/electric-motion-sizing](http://www.festo.com/x/electric-motion-sizing)

## Key features

Complete system comprising spindle axis, motor, motor controller and motor mounting kit

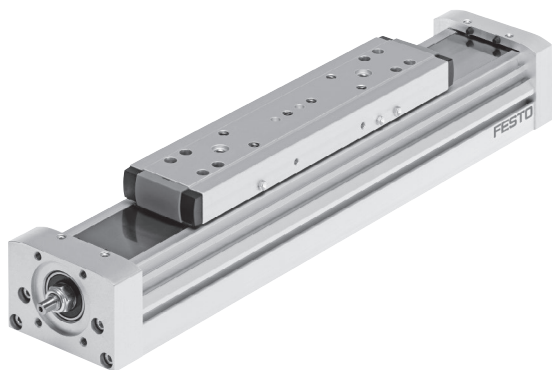

### Motor → Page 32



Servo motor:  
EMMT-AS, EMME-AS  
Stepper motor:  
EMMS-ST

**Note**  
A range of specially adapted complete solutions is available for the spindle axis ELGA and the motors.

### Servo drive



Servo drive:  
CMMT-AS  
Servo drive for extra-low voltage:  
CMMT-ST

### Motor mounting kit

Axial kit → Page 32

Parallel kit → Page 36

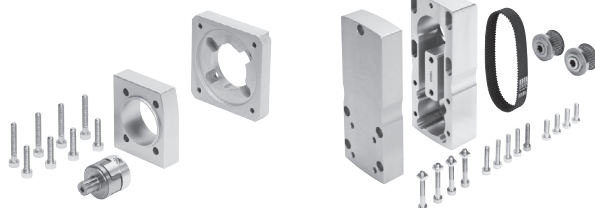

A range of complete kits is available for both parallel and axial motor mounting.

## Key features

### System product for handling and assembly technology

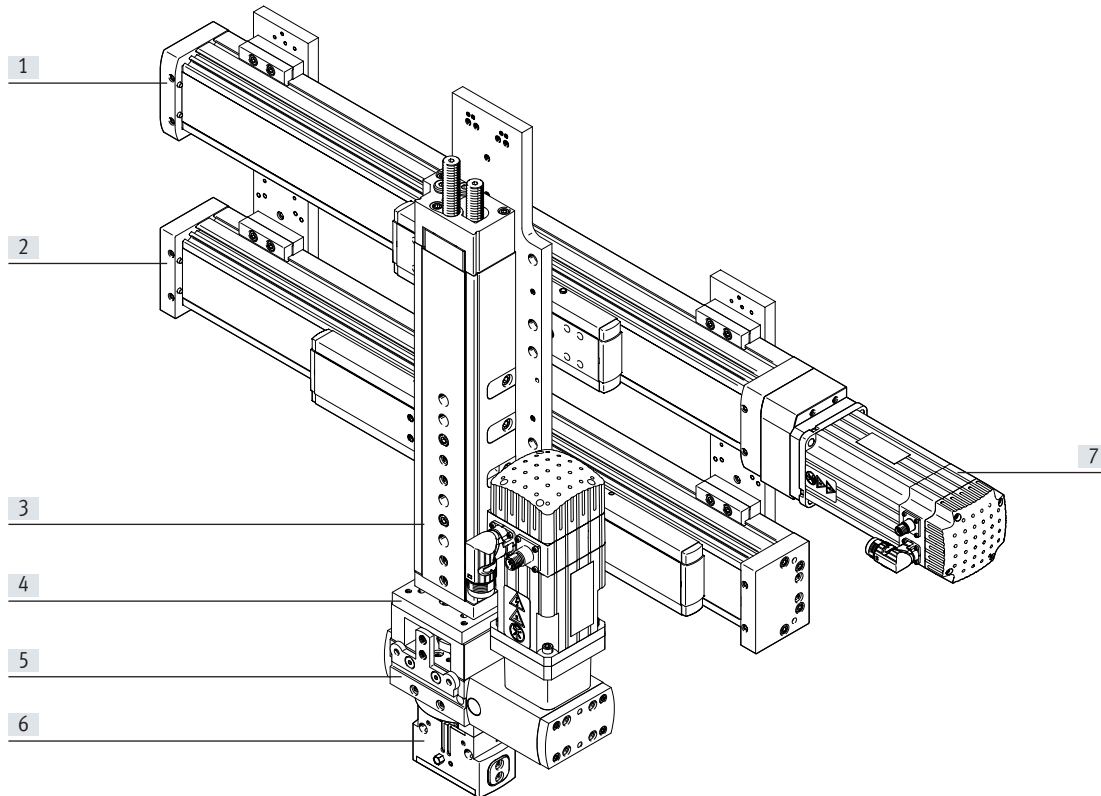

### System components and accessories

	Description	→ Internet
[1] Axes	Wide range of combinations possible within handling and assembly technology	axis
[2] Guide axes	To support force and torque capacity in multi-axis applications	guide axis
[3] Drives	Wide range of combinations possible within handling and assembly technology	drive
[4] Adapters	For drive/drive and drive/gripper connections	gripper
[5] Semi-rotary drives	Wide range of variations possible within handling and assembly technology	semi-rotary drive
[6] Grippers	Wide range of variations possible within handling and assembly technology	gripper
[7] Motors	Servo and stepper motors, with or without gear unit	motor

Peripherals overview

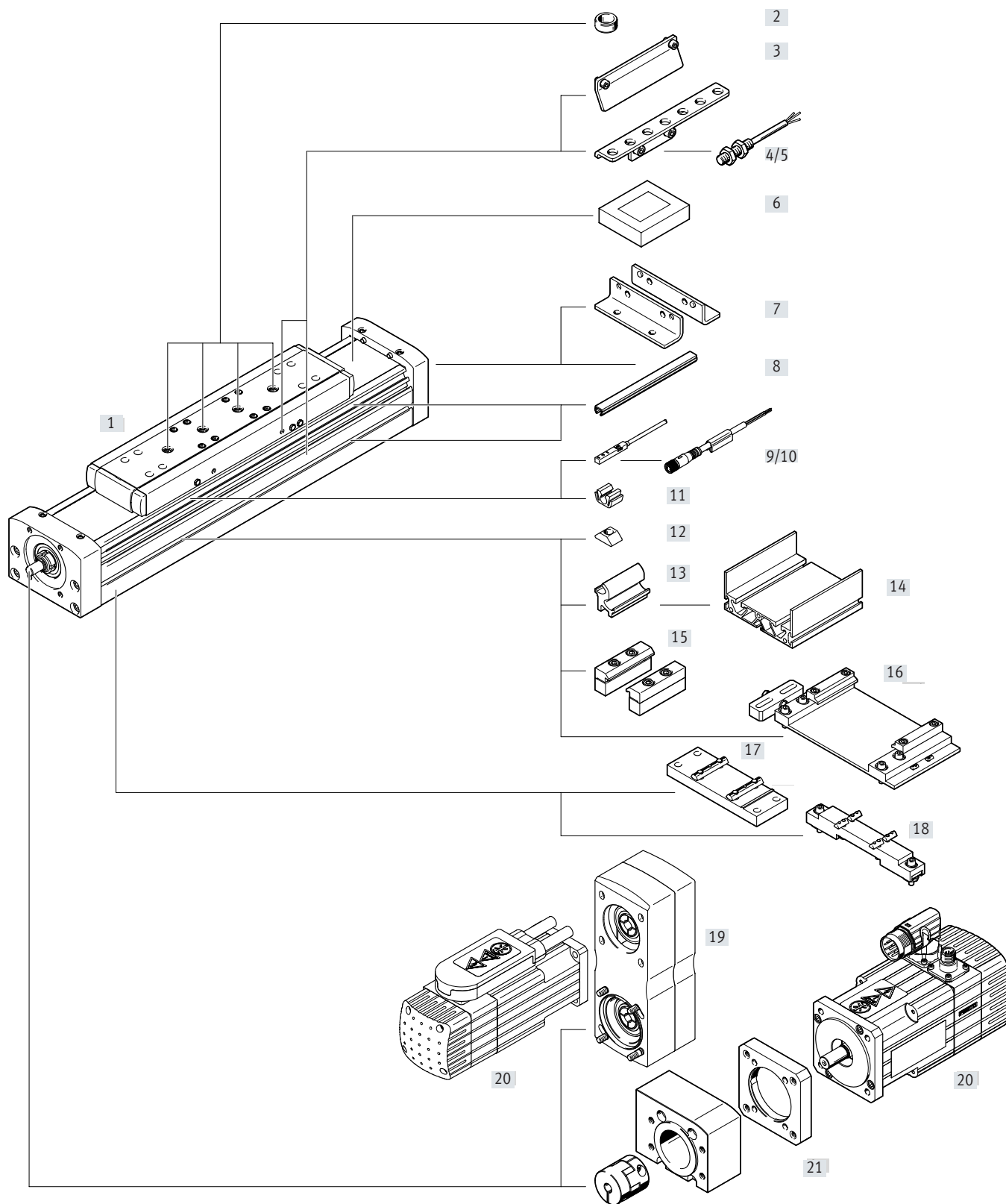



## Peripherals overview

Accessories		
Type	Description	→ Page/Internet
[1] Spindle axis ELGA-BS-KF	Electric drive	10
[2] Centring pin/sleeve ZBS, ZBH	<ul style="list-style-type: none"> <li>For centring loads and attachments on the slide</li> <li>Included in the scope of delivery: <ul style="list-style-type: none"> <li>With size 70: 2x ZBS-5</li> <li>With size 80, 120, 150: 2x ZBH-9</li> </ul> </li> </ul>	45
[3] Switch lug SF-EGC	For sensing the slide position	43
[4] Sensor bracket HWS-EGC	For mounting the inductive proximity sensors (round design) on the axis	44
[5] Proximity sensor, M8 SIEN-M8	Inductive proximity sensor, round design	47
[6] Clamping element EADT	Tool for retensioning the cover strip	45
[7] Foot mounting HPE	<ul style="list-style-type: none"> <li>For mounting the axis on the end cap</li> <li>With higher forces and torques, the axis should be mounted using the profile</li> </ul>	38
[8] Slot cover ABP	For protection against contamination	45
[9] Proximity sensor, T-slot SIES-8M	Inductive proximity sensor, for T-slot	46
[10] Connecting cable NEBU, SIM	For proximity sensor	47
[11] Clip SMBK	For mounting the proximity sensor cable in the slot	45
[12] Slot nut NST	For mounting attachments	45
[13] Adapter kit DHAM	For mounting the support profile on the axis	46
[14] Support profile HMIA	For mounting and guiding an energy chain	46
[15] Profile mounting MUE	For mounting the axis on the side of the profile	39
[16] Adjusting kit EADC-E16	For mounting the axis on a vertical surface. Once mounted, the axis can be aligned horizontally	42
[17] Central support EAHF-L5	For mounting the axis on the profile from underneath	40
[18] Adjusting kit EADC-E15	Is height-adjustable. Can be used to easily compensate for any unevenness in the bearing surface	41
[19] Parallel kit EAMM-U	For parallel motor mounting (comprising: housing, clamping sleeve, toothed belt pulley, toothed belt)	36
[20] Motor EMME, EMMT, EMMS	Motors specially matched to the axis, with or without gear unit, with or without brake	32
[21] Axial kit EAMM-A	For axial motor mounting (comprising: coupling, coupling housing and motor flange)	32

## Type codes



001	Series
ELGA	Gantry axis
002	Drive system
BS	Ball screw drive
003	Guide
KF	Recirculating ball bearing guide
004	Size
70	70
80	80
120	120
150	150
005	Stroke range [mm]
...	50 ... 3000
006	Stroke reserve
...H	0 ... 999 mm
007	Spindle pitch
10P	10 mm
20P	20 mm
25P	25 mm
40P	40 mm

008	Motor attachment position
ML	Left
MR	Right
009	Additional slide
	None
ZL	1 slide left
ZR	1 slide right
010	Protection against particles
	Standard
P11	Cover strip with magnetic deflection
011	Displacement encoder
	None
M1	With displacement encoder, incremental, resolution 2.5 µm
M2	With displacement encoder, incremental, resolution 10 µm
012	Displacement encoder attachment position
	None
F	Front
B	Rear

## Data sheet

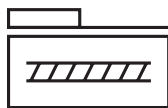
## Function



-  Size  
70 ... 150
-  Stroke length  
50 ... 3000 mm
-  [www.festo.com](http://www.festo.com)

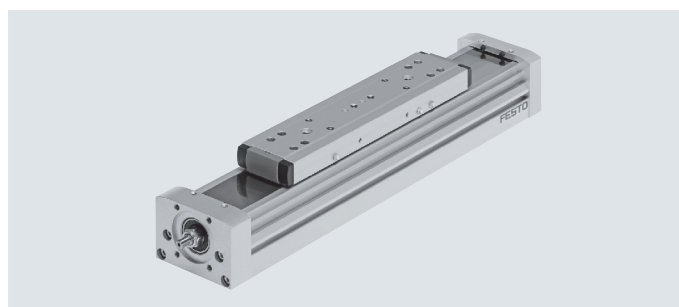

## General technical data

Size	70	80	120	150		
Spindle pitch [mm/rev]	10	10	20	10	25	40
Design	Electromechanical axis with ball screw					
Guide	Recirculating ball bearing guide					
Mounting position	Any					
Working stroke [mm]	50 ... 900	50 ... 1940	50 ... 2460	50 ... 3000		
Max. feed force $F_x^{1)}$ [N]	650	1600	3400	6400		
No-load torque [Nm]	0.17	0.3	0.35	1.0	1.0	2.2
at min. travel speed [m/s]	0.05	0.1		0.2		0.2
No-load torque [Nm]	0.45	0.75	0.75	2.25	2.25	6.5
at max. travel speed [m/s]	0.5	0.5	1	0.6	1.5	2
Max. radial force <sup>2)</sup> [N]	220	250		500		4000
Max. speed [m/s]	0.5	0.5	1	0.6	1.5	2
Max. rotational speed <sup>3)</sup> [rpm]	3000	3000		3600		3000
Max. acceleration [m/s <sup>2</sup> ]	15					
Repetition accuracy [mm]	±0.02					

1) The feed force affects the service life. (→ Page 16)

2) At the driving shaft

3) Rotational speed and speed are stroke-dependent

## Operating and environmental conditions

Ambient temperature [°C]	-10 ... +60
Degree of protection	IP40
Duty cycle [%]	100

## Weight [g]

Size	70	80	120	150
Basic weight with 0 mm stroke <sup>1)</sup>	2160	3800	10500	25100
Additional weight per 10 mm stroke	33	46	99	210
Moving mass				
ELGA-...	804	1370	4459	10514
ELGA-...-ZL/ZR	620	1110	3600	5900

1) Including slide

## Spindle

Size	70	80	120	150		
Diameter [mm]	12	15	25	40		
Pitch [mm/rev]	10	10	20	10	25	40

## Data sheet

Mass moment of inertia		70		80		120		150	
Size									
Spindle pitch	[mm/rev]	10	10	20	10	25	40		
$J_0$	[kg mm <sup>2</sup> ]	3.8	9.7	9.7	103.8	103.8	863		
$J_S$ per metre stroke	[kg mm <sup>2</sup> /m]	14.2	34.6	34.6	275.6	275.6	1803.1		
$J_L$ per kg payload	[kg mm <sup>2</sup> /kg]	2.53	2.53	10.13	2.53	15.83	40.53		

The mass moment of inertia  $J_{rot}$  of the rotating parts of the axis is calculated as follows:

$$J_{rot} = J_0 + J_S \times \text{working stroke [m]}$$

### Materials

Sectional view

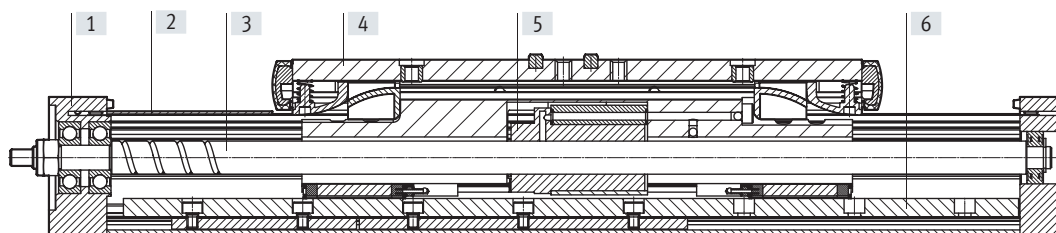

Axis		
[1]	Drive cover	Anodised wrought aluminium alloy
[2]	Cover strip	Stainless steel strip, non-corroding
[3]	Spindle	Steel
[4]	Slide	Anodised wrought aluminium alloy
[5]	Spindle nut	Steel
[6]	Profile with integrated guide	Anodised wrought aluminium alloy
	Note on materials	RoHS-compliant
		Contains paint-wetting impairment substances

## Data sheet

Technical data – Displacement encoder		Dimensions → page 28	
Type		ELGA-...-M1	ELGA-...-M2
Resolution	[ $\mu\text{m}$ ]	2.5	10
Max. travel speed with displacement encoder	[m/s]	4	4
Encoder signal		5 V TTL; A/A, B/B; reference signal (N/N) cyclically every 5 mm (zero pulse)	
Signal output		Line driver, alternating, resistant to sustained short circuit	
Electrical connection		8-pin plug, round design, M12	
Cable length	[mm]	160	

Operating and environmental conditions – Displacement encoder	
Ambient temperature	[ $^{\circ}\text{C}$ ] -10 ... +70
Degree of protection	IP64
CE marking (see declaration of conformity)	To EU EMC Directive <sup>1)</sup>

1) For information about the area of use, see the EC declaration of conformity at: [www.festo.com/sp](http://www.festo.com/sp) → Certificates.

If the devices are subject to usage restrictions in residential, commercial or light-industrial environments, further measures for the reduction of the emitted interference may be necessary.

## Note regarding use

The spindle axis with displacement encoder is not designed for the following application examples:

- Magnetic field

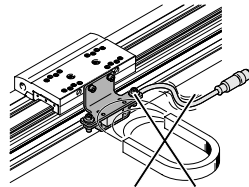

- Welding application

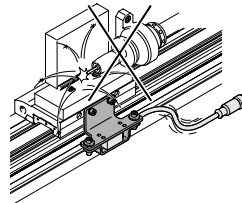

## Data sheet

### Characteristic load values

The indicated forces and torques refer to the centre of the guide. The point of application of force is the point where the centre of the guide and the longitudinal centre of the slide intersect. These values must not be exceeded during dynamic operation. Special attention must be paid to the deceleration phase.

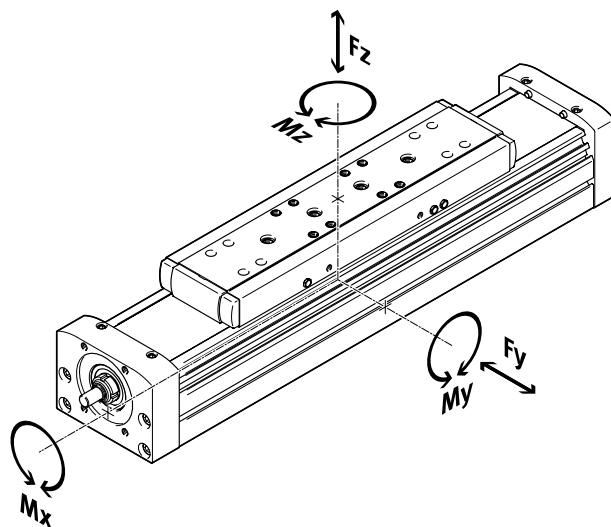

Distance from the slide surface to the centre of the guide

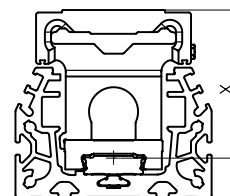

Distance from the slide surface to the centre of the guide		70		80		120		150	
Size		70	80	120	150				
Dimension x	[mm]	51	60	87	111				

Max. permissible forces and torques for a service life of 5000 km		70		80		120		150	
Size		70	80	120	150				
F <sub>y</sub> max.	[N]	1500	2500	5500	5500				
F <sub>z</sub> max.	[N]	1850	3050	6890	11000				
M <sub>x</sub> max.	[Nm]	16	36	104	167				
M <sub>y</sub> max.	[Nm]	132	228	680	1150				
M <sub>z</sub> max.	[Nm]	132	228	680	1150				

Basic load ratings		70		80		120		150	
Size		70	80	120	150				
Spindle pitch	[mm/rev]	10	10	20	10	25	40		

Ball screw		70		80		120		150	
Dynamic c <sub>dyn,BSD</sub>	[N]	4000	6800	5700	14100	12700	25000		

### Note

For a guide system to have a service life of 5000 km, the load comparison factor must have a value of  $f_v \leq 1$ , based on the maximum permissible forces and torques for a service life of 5000 km.

If the axis is subjected to two or more of the indicated forces and torques simultaneously, the following equation must be satisfied in addition to the indicated maximum loads:

Calculating the load comparison factor:

$$f_v = \frac{|F_{z1}|}{F_{z\max}} + \frac{|F_{y1}|}{F_{y\max}} + \frac{|M_{z1}|}{M_{z\max}} + \frac{|M_{y1}|}{M_{y\max}} + \frac{|M_{x1}|}{M_{x\max}} \leq 1$$

F<sub>1</sub>/M<sub>1</sub> = dynamic value

F<sub>2</sub>/M<sub>2</sub> = maximum value

## Data sheet

### Service life of the guide

The service life of the guide depends on the load. To be able to make a statement as to the service life of the guide, the graph below plots the load comparison factor  $f_v$  against the service life.

These values are only theoretical. You must consult your local Festo contact for a load comparison factor  $f_v$  greater than 1.5.

#### Load comparison factor $f_v$ as a function of service life

Example:

A user wants to move an  $x$  kg load. Using the formula (→ page 14) gives a value of 1.5 for the load comparison factor  $f_v$ . According to the graph, the guide would have a service life of approx. 1500 km. Reducing the acceleration reduces the  $M_y$  and  $M_z$  values. A load comparison factor  $f_v$  of 1 now gives a service life of 5000 km.

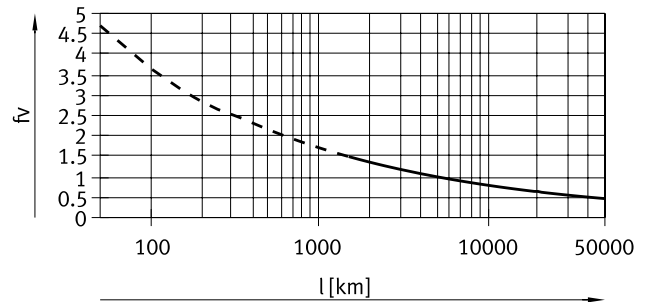

#### Note

Engineering software  
Electric Motion Sizing  
[www.festo.com/x/electric-motion-sizing](http://www.festo.com/x/electric-motion-sizing)

The engineering software can be used to calculate the guide workload for a service life of 5000 km.

$f_v > 1.5$  are only theoretical comparison values for the recirculating ball bearing guide.

### Comparison of the characteristic load values for 5000 km with dynamic forces and torques of recirculating ball bearing guides

The characteristic load values of bearing guides are standardised to ISO and JIS using dynamic and static forces and torques. These forces and torques are based on an expected guide system service life of 100 km to ISO or 50 km to JIS. As the characteristic load values are dependent on the service life, the maximum permissible forces and torques for a 5000 km service life cannot be compared with the dynamic forces and torques of bearing guides to ISO/JIS.

To make it easier to compare the guide capacity of linear axes ELGA with bearing guides, the table below lists the theoretically permissible forces and torques for a calculated service life of 100 km. This corresponds to the dynamic forces and torques to ISO.

These 100 km values have been calculated mathematically and are only to be used for comparing with dynamic forces and torques to ISO. The drives must not be loaded with these characteristic values as this could damage the axes.

Max. permissible forces and torques for a theoretical service life of 100 km (from a guide perspective only)					
Size		70	80	120	150
$F_{y_{max}}$	[N]	5520	9200	20240	20240
$F_{z_{max}}$	[N]	6808	11224	25355	40480
$M_{x_{max}}$	[Nm]	59	132	383	615
$M_{y_{max}}$	[Nm]	486	839	2502	4232
$M_{z_{max}}$	[Nm]	486	839	2502	4232

## Data sheet

### Service life of the spindle

- The service life of the spindle axis depends on the service life of the guide (→ page 15) and of the ball screw. The operating coefficient plays a considerable role in determining the possible service life. It can be determined with the help of the table (→ page 17)
- The service life ends when the maximum number of switching cycles or maximum running performance has been reached:
  - 5 million switching cycles or 5000 km running performance
- The distance between the furthest and rearmost positions must be at least 2.5 times the spindle pitch per travel cycle
- The specifications for running performance are based on experimentally determined and theoretically calculated data (at room temperature). The running performance that can be achieved in practice can deviate considerably from the specified curves under different parameters

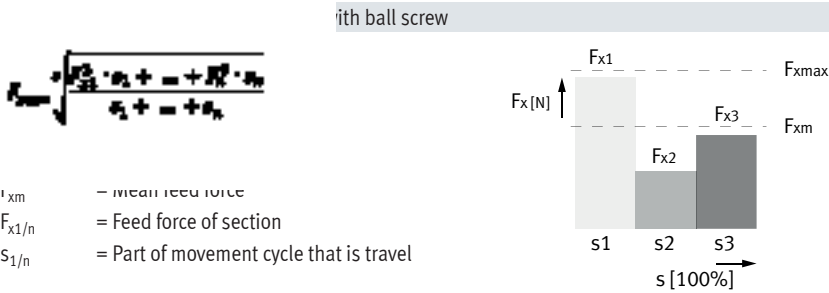

Mean feed force  $F_{xm}$  as a function of running performance  $L$ , with an operating coefficient  $f_B$  of 1.0, at room temperature

Size 70

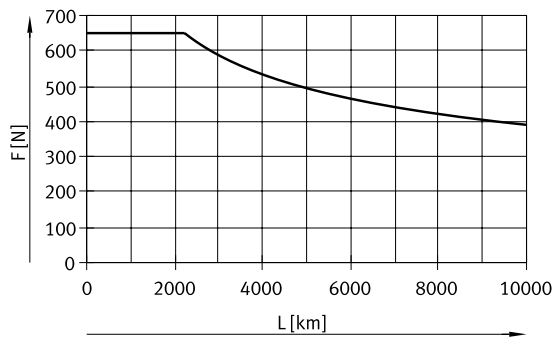

Size 80

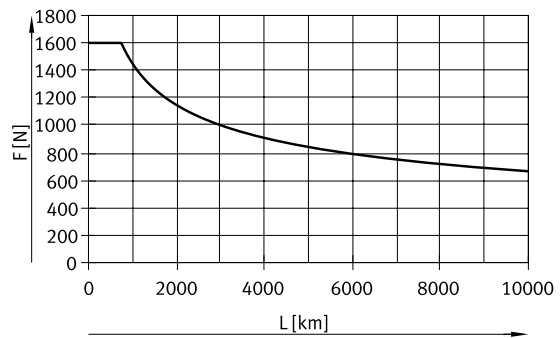



Data sheet

Mean feed force  $F_{xm}$  as a function of running performance L, with an operating coefficient  $f_B$  of 1.0, at room temperature

Size 120

Size 150

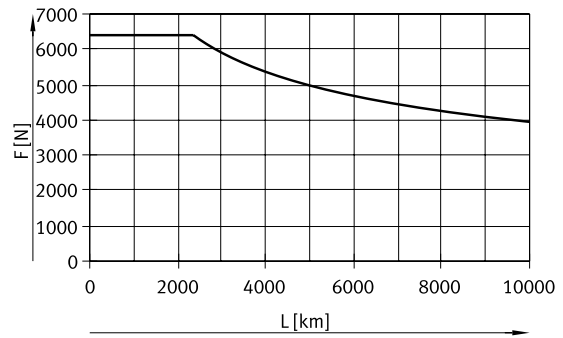
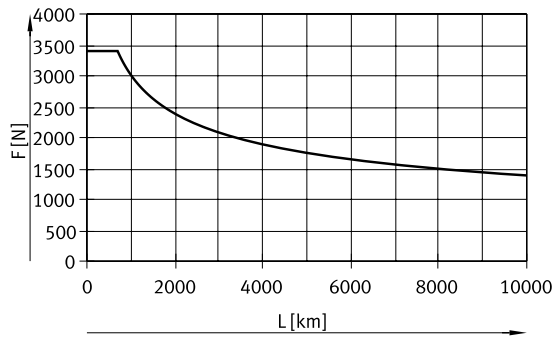

Service life taking into account the operating coefficient

$$L_{act} = \frac{L}{f_B}$$

$L_{act}$  = Actual service life  
 $L$  = Target service life  
 (→ graphs)  
 $f_B$  = Operating coefficient

Load <sup>1)</sup>	Operating coefficient $f_B$	Application example
None	1.0 ... 1.2	Measuring machine
Light	1.2 ... 1.4	Handling, robotics
Medium	1.4 ... 1.6	Press-in operations
High	1.6 ... 2.0	Construction, agriculture

1) Loads caused by impact, temperature, contamination, shock and vibrations

Data sheet

Speed  $v$  as a function of working stroke  $l$

Size 70

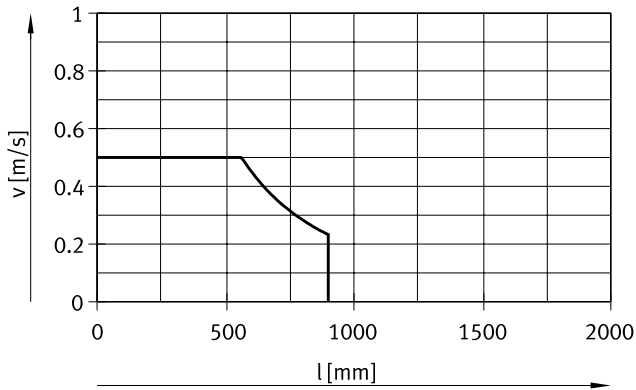

— ELGA-70-10P

Size 80

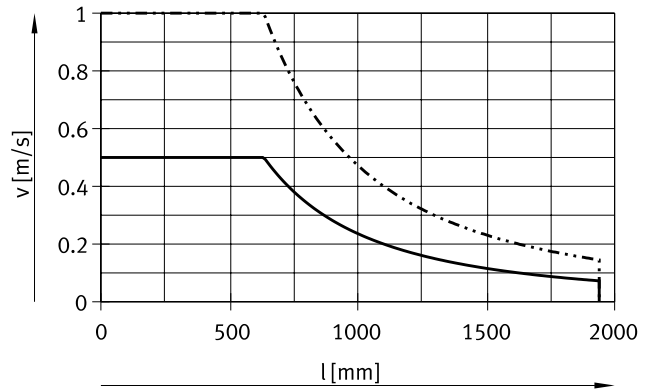

— ELGA-80-10P  
 - - - ELGA-80-20P

Size 120

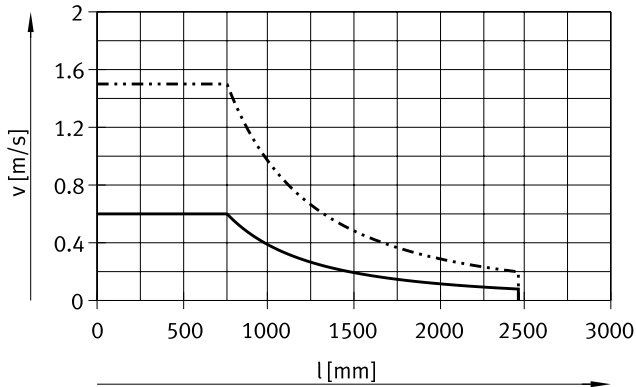

— ELGA-120-10P  
 - - - ELGA-120-25P

Size 150

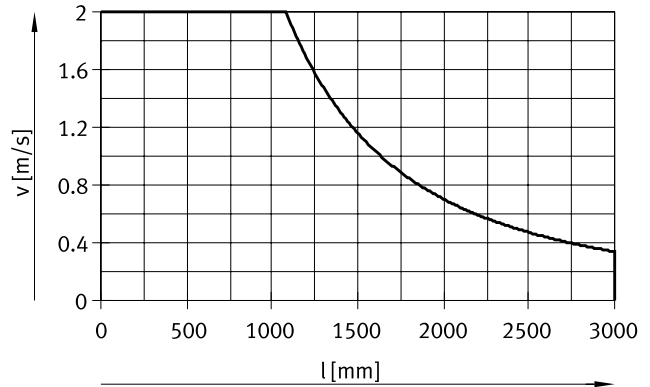

— ELGA-150-40P

Velocity  $v$  as a function of rotational speed  $n$

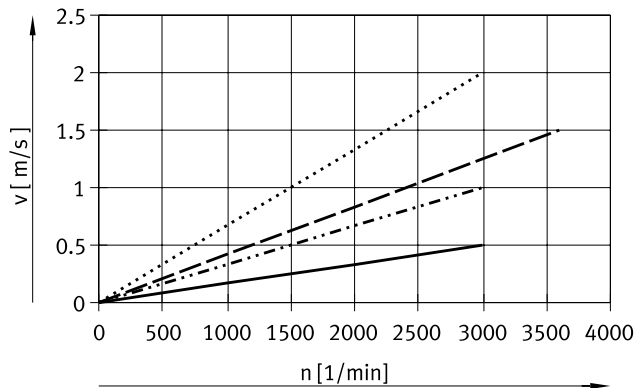

 **Note**  
 Rotational speed is stroke-dependent. Note maximum rotational speed.

— ELGA-70-10P/-80-10P/-120-10P  
 - - - ELGA-80-20P  
 - - - ELGA-120-25P  
 - · - · ELGA-150-40P

Data sheet

Max. acceleration  $a$  as a function of payload  $m$

Size 70

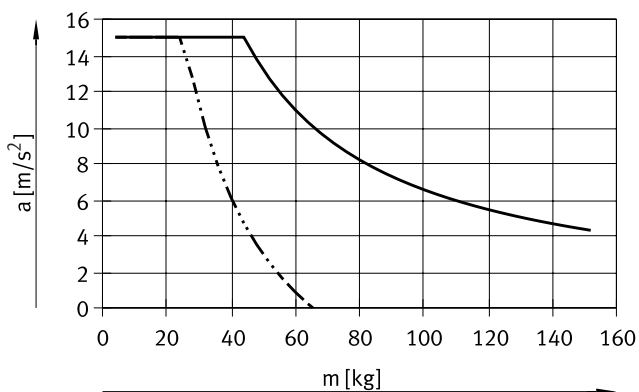

Size 80

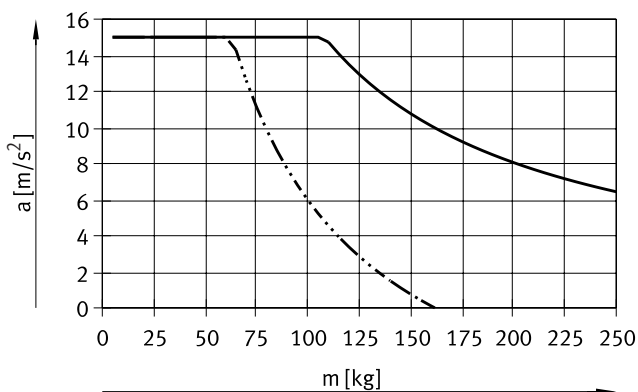

Size 120

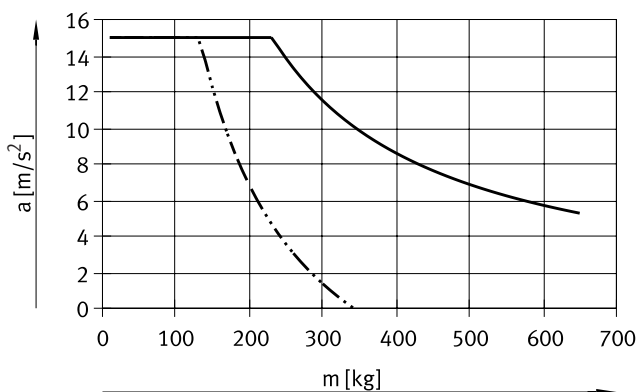

Size 150

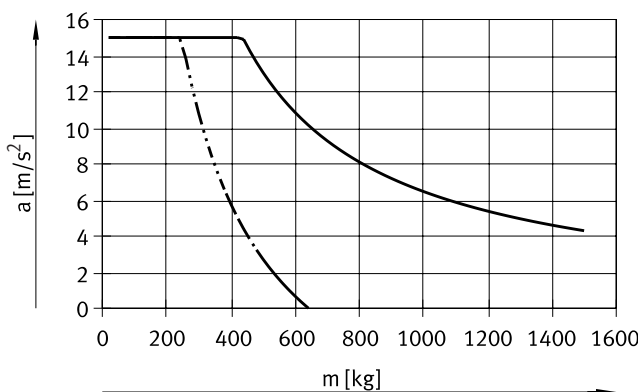

- Horizontal mounting position
- Vertical mounting position

Theoretical feed force  $F$  as a function of input torque  $M$

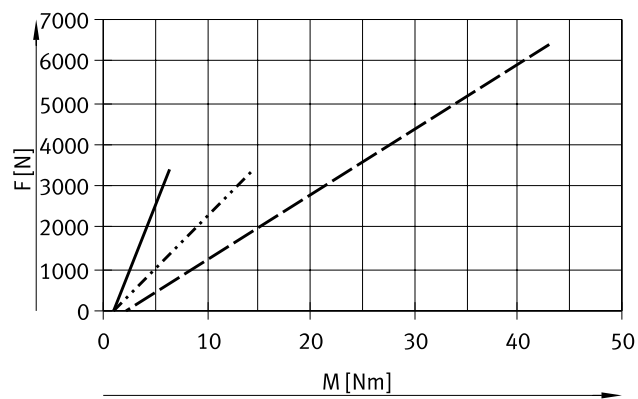
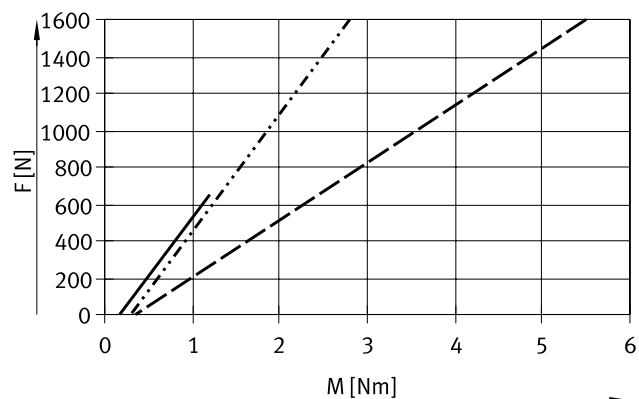

- ELGA-70-10P
- ELGA-80-10P
- - - ELGA-80-20P

- ELGA-120-10P
- ELGA-120-25P
- - - ELGA-150-40P

## Data sheet

### Stroke reserve

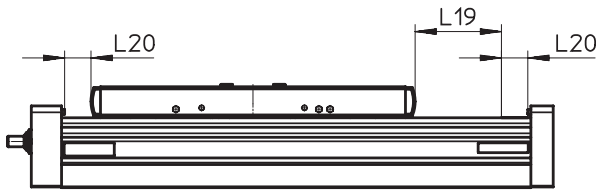

L19 = Nominal stroke  
L20 = Stroke reserve

- The stroke reserve is a safety distance from the mechanical end position and is not used in normal operation
- The sum of the nominal stroke and 2x stroke reserve must not exceed the maximum permissible working stroke
- The length can be freely selected
- The stroke reserve is defined via the "stroke reserve" characteristic in the modular product system

### Example:

Type ELGA-BS-KF-70-500-20H-...

Nominal stroke = 500 mm

2x stroke reserve = 40 mm

Working stroke = 540 mm

(540 mm = 500 mm + 2x 20 mm)

### Working stroke reduction

With axis ELGA with additional slide ZL/ZR

For a spindle axis with additional slide, the working stroke is reduced by the length of the additional slide and the distance between both slides

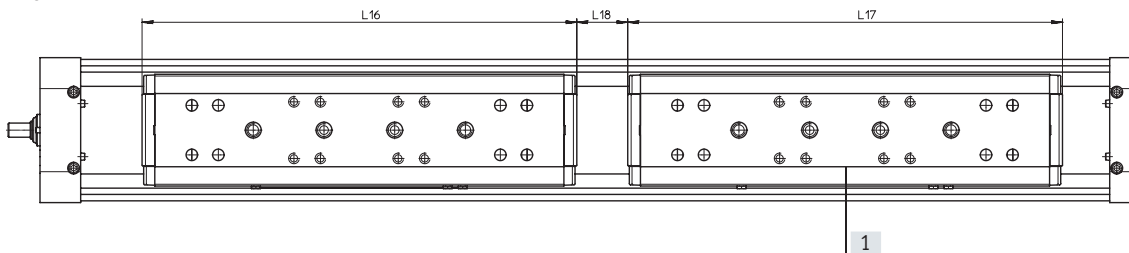

L16 = Slide length  
L17 = Additional slide length  
L18 = Distance between the two slides  
[1] Additional slide

**Example:**  
Type ELGA-BS-KF-70-500-...-ZR  
Working stroke without additional slide = 500 mm  
L18 = 50 mm  
L16, L17 = 221 mm  
Working stroke with additional slide = 229 mm  
(500 mm – 50 mm – 221 mm)

### Dimensions – Additional slide

Size	70	80	120	150
Length L17 [mm]	221	246	335	378.4
Min. distance between the slides L18 [mm]	≥ 50	≥ 50	≥ 50	≥ 50

## Data sheet

## 2nd moments of area

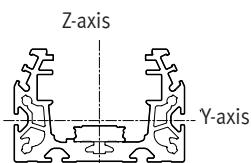

Size		70	80	120	150
$I_y$	[mm <sup>4</sup> ]	$165 \times 10^3$	$310 \times 10^3$	$1.24 \times 10^6$	$4.70 \times 10^6$
$I_z$	[mm <sup>4</sup> ]	$472 \times 10^3$	$977 \times 10^3$	$3.80 \times 10^6$	$11.81 \times 10^6$

## Maximum permissible support spacing L (without profile mounting MUE/central support EAHF) as a function of force F

In order to limit deflection in the case of large strokes, the axis may need to be supported.

The following graphs can be used to determine the maximum permissible support spacing  $l$  as a function of force  $F$  acting on the axis. The deflection is  $f = 0.5$  mm.

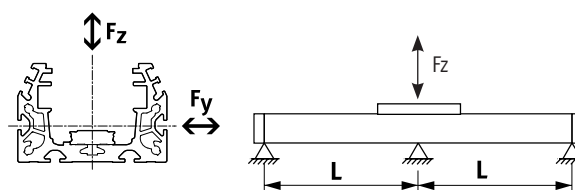
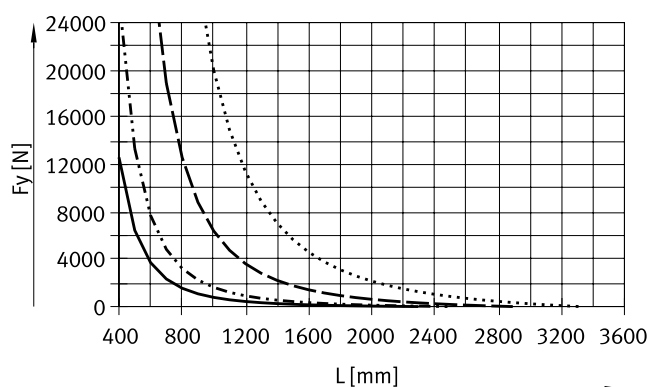
 Force  $F_y$ 

- ELGA-70
- ELGA-80
- - - ELGA-120
- · - · ELGA-150

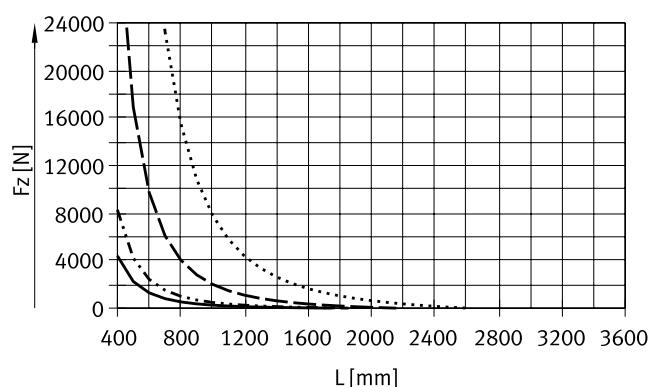
 Force  $F_z$ 

## Recommended deflection limits

Adherence to the following deflection limits is recommended so as not to impair the functionality of the axes.

Greater deformation can result in increased friction, greater wear and reduced service life.

Size	Dynamic deflection (moving mass)	Static deflection (stationary load)
70 ... 150	0.05% of the axis length, max. 0.5 mm	0.1% of the axis length

## Data sheet

### Central lubrication

The lubrication connections enable the guide and the ball screw of the spindle axis ELGA-BS-KF to be permanently lubricated in applications in humid or wet ambient conditions using semi- or fully automatic relubrication devices.

- The axes are suitable for oils and greases
- The connection option is already available in the standard design of the axes
- There is a dedicated lubrication connection for the spindle nut and the two ball cassettes

Slide dimensions  
→ page 23

### Structure of a central lubrication system

A central lubrication system requires various additional components. The illustration shows different options (using a hand pump, pneumatic container pump or electric container pump) required as a minimum for designing a central lubrication system. Festo does not sell these additional components; however, they can be obtained from the following companies:

- Lincoln
- Bielomatik
- SKF (Vogel)

Festo recommends these companies because they can supply all the necessary components.

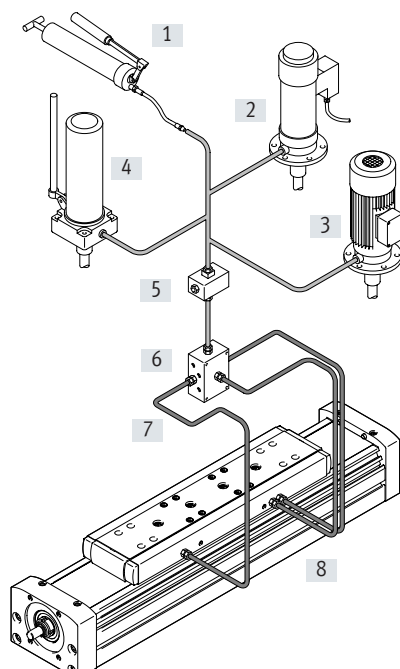

- [1] Hand pump
- [2] Pneumatic container pump
- [3] Electric container pump
- [4] Manually operated container pump
- [5] Nipple block
- [6] Distributor block
- [7] Tubing or piping
- [8] Fittings

Data sheet

Dimensions

Download CAD data → [www.festo.com](http://www.festo.com)

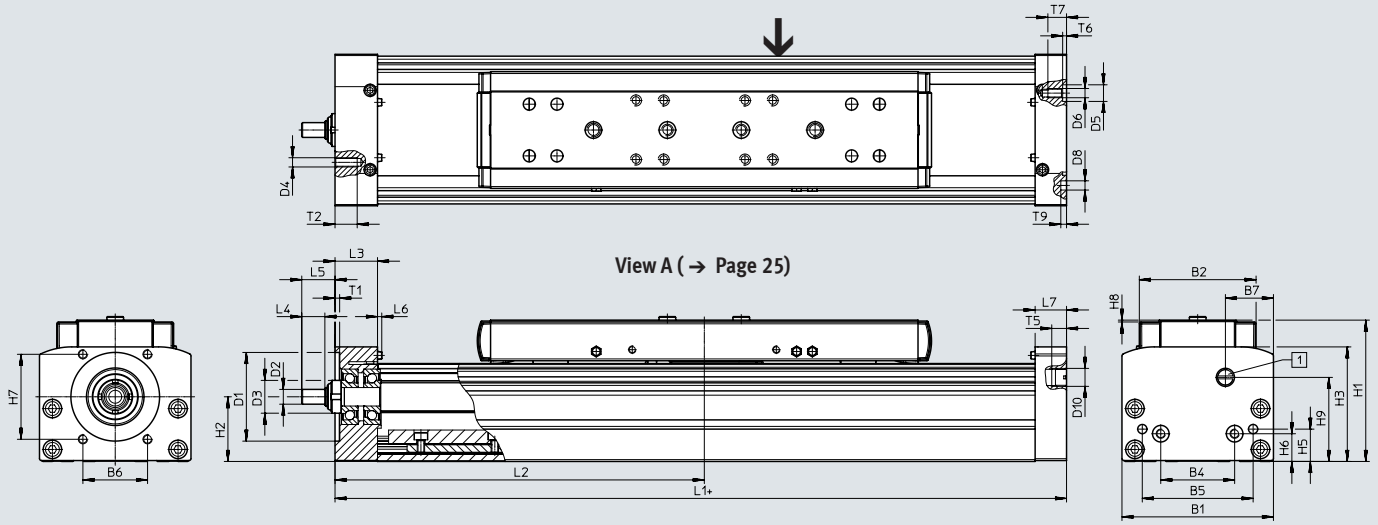

View A (→ Page 25)

+ = plus stroke length + 2x stroke reserve

[1] Sealing air connection

Size	B1	B2	B4	B5	B6	B7	D1 ∅	D2 ∅	D3 ∅	D4	D5 ∅ H7
70	69	48.2	30	45	29	21.5	38	6	A/F 13 mm	M5	–
80	82	63.2	40	60	35	26	48	8	18	M5	9
120	120	95	80	40	64	35	62	12	28	M6	–
150	154	125	40	80	80	42	95	25	44	M8	–

Size	D6	D8 ∅ H7	D10	H1	H2	H3	H5	H6	H7	H8	H9	L1
70	M5	5	G1/8	64	28.5	50.5	13	13	36	1	37.5	268
80	M5	5	G1/8	76.5	35	62	17.5	15	46	1	45.5	296
120	M8	9	G1/8	111.5	54	89	22	22	54	1	65.5	409
150	M8	9	G1/8	141.5	72.5	122	26.5	26.5	80	1	91	512

Size	L2 min.	L3	L4	L5	L6	L7	T1	T2	T5	T6	T7	T9
70	133.5	21	8	14	2.3	16	2.5	12	8	–	10	3.1
80	148.2	23	12.5	18	2.3	17	2.5	12	8	2.1	10.1	3.1
120	202.3	33	17.5	25.5	1.8	30	3	15	8	–	16	2.1
150	235.7	43	23	30.5	3.5	37	3	20	8	–	16	2.1

Data sheet

Dimensions

Download CAD data → [www.festo.com](http://www.festo.com)

Profile

Size 70

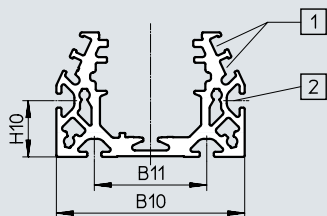

Size 80

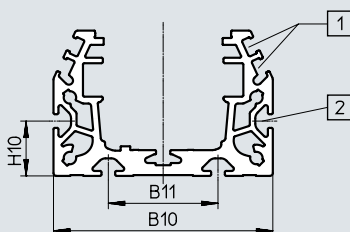

Size 120

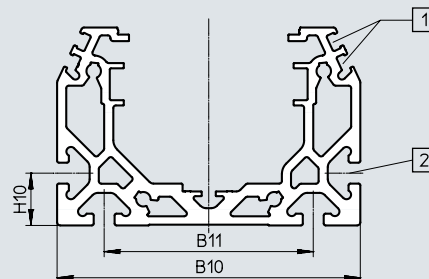

Size 150

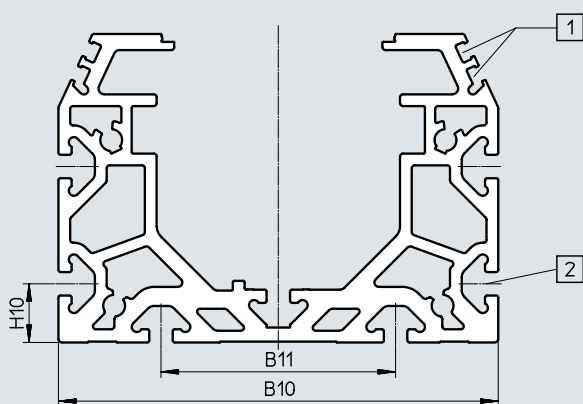

- [1] Sensor slot for proximity sensor
- [2] Mounting slot for slot nut  
 With size 70, 80: slot nut NST-5-M5  
 With size 120, 150: slot nut NST-8-M6

**Note**

Requirements for the evenness of the bearing surface and of attachments as well as for use in parallel structures

→ [www.festo.com/sp](http://www.festo.com/sp) User documentation.

Size	B10	B11	H10
70	67	40	20
80	80	40	20
120	116	80	20
150	150	80	20



Data sheet

Dimensions

Download CAD data → [www.festo.com](http://www.festo.com)

Slide

Size 70  
View A

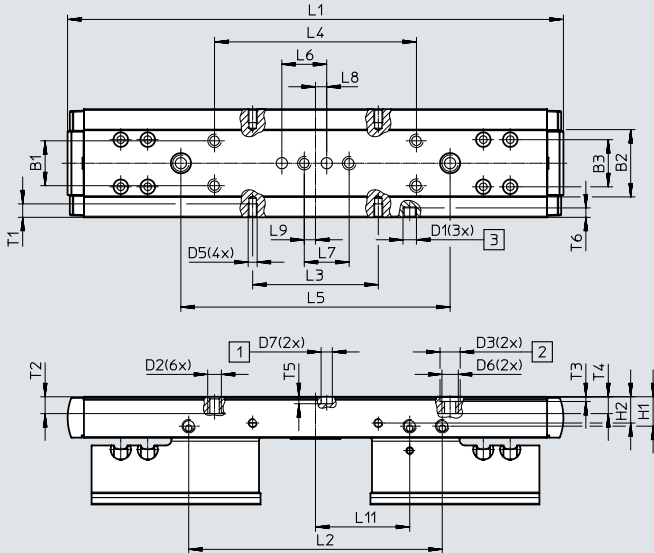

Size 80  
View A

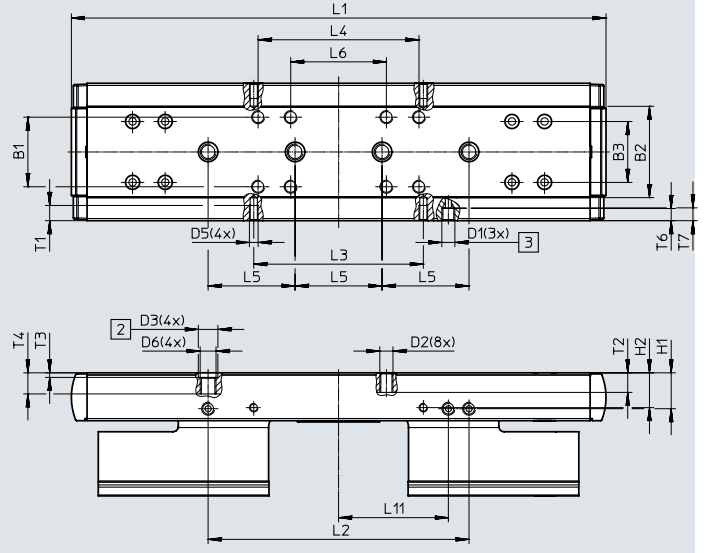

- [1] Drilled hole for centring pin ZBS
- [2] Drilled hole for centring sleeve ZBH
- [3] Lubrication connections

Size	B1	B2	B3	D1	D2	D3 ∅ H7	D5	D6	D7 ∅ H7
	±0.1	±0.2	±0.1						
70	20	30	21	M6	M5	9	M4	M6	5
80	32	42	28	M6	M5	9	M4	M6	-

Size	H1	H2	L1	L2	L3	L4	L5	L6	L7	L8
	±0.1			±0.1	±0.1	±0.1	±0.03	±0.1	±0.03	
70	13.1	11.7	221	113	56	90	120	20	20	5
80	16.5	16	246	120	78	74	40	44	-	-

Size	L9	L11	T1	T2	T3	T4	T5	T6		T7
								min.	max.	
					+0.1		+0.1			-0.1
70	5	42	6	7.5	2.1	7.5	3.1	4.2	4.6 <sub>-0.1</sub>	-
80	-	50.5	8	9	2.1	9.7	-	5.6	5.9 <sub>-0.1</sub>	5.9

Data sheet

Dimensions

Download CAD data → [www.festo.com](http://www.festo.com)

Slide

Size 120

View A

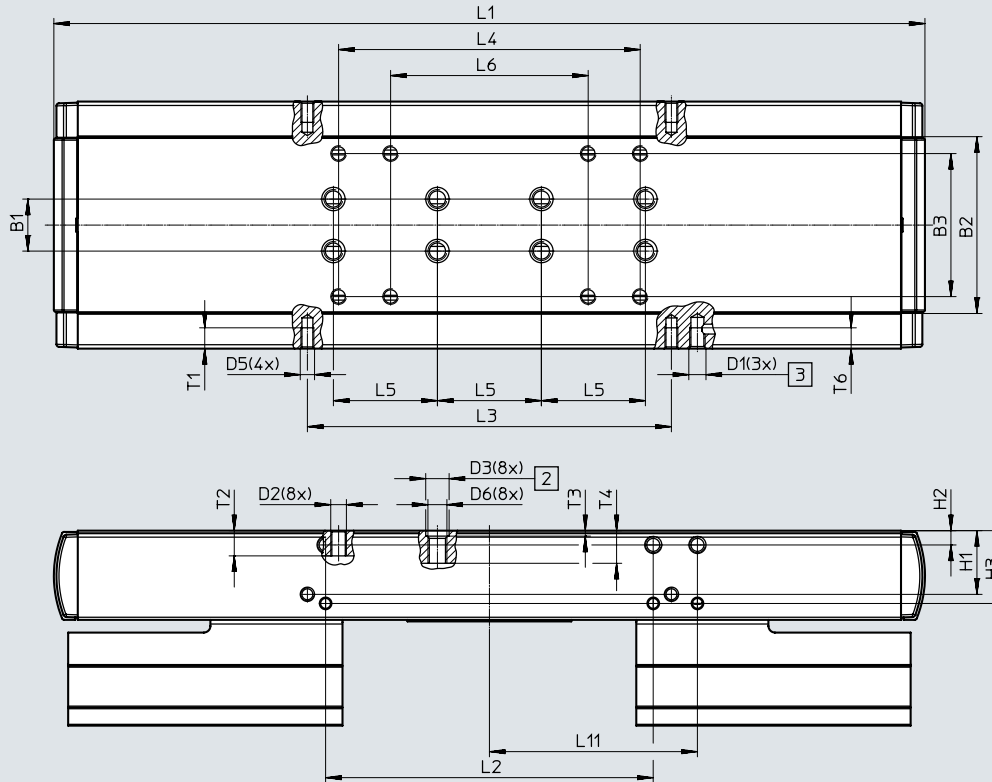

[2] Drilled hole for centring sleeve ZBH

[3] Lubrication connections

Size	B1	B2	B3	D1	D2	D3 ∅ H7	D5	D6	H1	H2	H3	L1
120	±0.03 20	±0.2 68	±0.1 55	M6	M5	9	M5	M6	24.5	5.5	28	335
Size	L2	L3	L4	L5	L6	L11	T1	T2	T3	T4	T6	
120	±0.1 126	±0.1 140	±0.2 116	±0.03 40	±0.2 76	80	8	9.7	+0.1 2.1	12.55	8	

Data sheet

Dimensions

Download CAD data → [www.festo.com](http://www.festo.com)

Slide

Size 150

View A

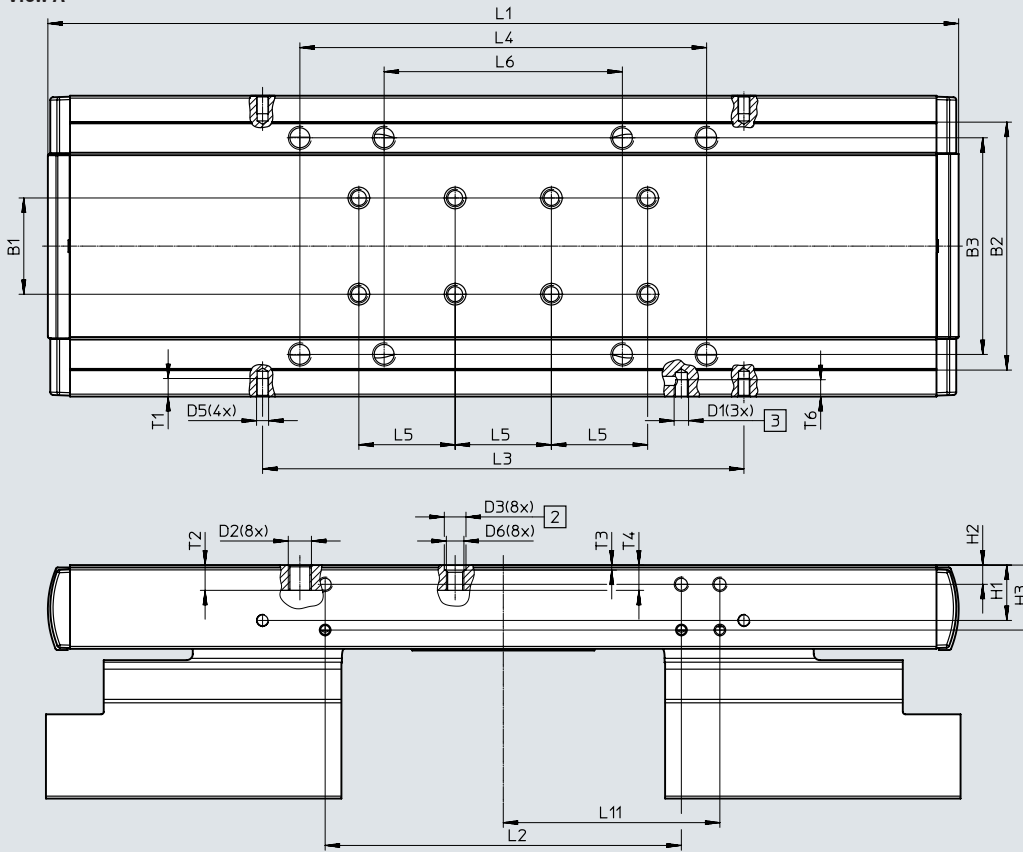

- [2] Drilled hole for centring sleeve ZBH
- [3] Lubrication connections

Size	B1	B2	B3	D1	D2	D3 ∅ H7	D5	D6	H1	H2	H3	L1
150	±0.03 40	±0.2 103	±0.1 90	M6	M8	9	M5	M6	23	8	27	378.4

Size	L2	L3	L4	L5	L6	L11	T1	T2	T3	T4	T6
150	±0.1 148	±0.1 200	±0.2 169	±0.03 40	±0.2 99	90	7.5	10.7	+0.1 2.1	14	7

Data sheet

Dimensions

Download CAD data → [www.festo.com](http://www.festo.com)

ELGA-...-M1/M2 – With incremental displacement encoder

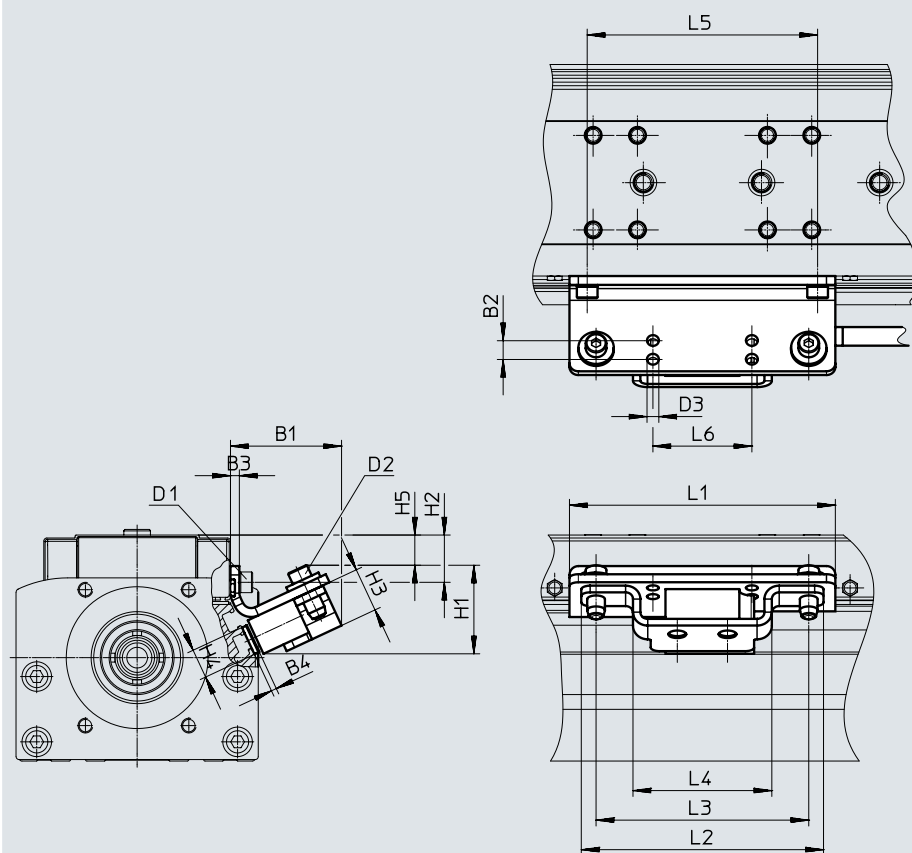

Encoder cable  
(connection to motor controller/  
safety system)  
→ Page 47

Size	B1	B2	B3	B4	D1	D2	D3 ∅	H1	H2
70	40	7	3	1.8	M4x8	M4x14	4	35	11.7
80	40	7	3	1.8	M4x14	M4x14	4	35	16
120	41	7	3	1.8	M4x14	M4x14	4	35	24.5
150	42	7	3	1.8	M5x10	M4x14	4	35	23

Size	H3	H4	H5	L1	L2	L3	L4	L5	L6
70	15	10	3.5	86	82	72	47	56	33.5
80	15	10	9	90	82	72	47	78	33.5
120	15	10	21	170	82	72	47	140	33.5
150	15	10	22.4	220	82	72	47	200	33.5

## Data sheet

## Ordering data – Standard design

## Key features:

- Stroke reserve: 0 mm
- Motor attachment position: left

Size	Pitch [mm/rev]	Stroke [mm]	Part no.	Type
70	10	100	8041816	ELGA-BS-KF-70-100-0H-10P-ML
		200	8041817	ELGA-BS-KF-70-200-0H-10P-ML
		300	8041818	ELGA-BS-KF-70-300-0H-10P-ML
		400	8041819	ELGA-BS-KF-70-400-0H-10P-ML
		500	8041820	ELGA-BS-KF-70-500-0H-10P-ML
		600	8041821	ELGA-BS-KF-70-600-0H-10P-ML
80	10	100	8041822	ELGA-BS-KF-80-100-0H-10P-ML
		200	8041823	ELGA-BS-KF-80-200-0H-10P-ML
		300	8041824	ELGA-BS-KF-80-300-0H-10P-ML
		400	8041825	ELGA-BS-KF-80-400-0H-10P-ML
		500	8041826	ELGA-BS-KF-80-500-0H-10P-ML
		600	8041827	ELGA-BS-KF-80-600-0H-10P-ML
		800	8041828	ELGA-BS-KF-80-800-0H-10P-ML
		20	100	8041829
	200		8041830	ELGA-BS-KF-80-200-0H-20P-ML
	300		8041831	ELGA-BS-KF-80-300-0H-20P-ML
	400		8041832	ELGA-BS-KF-80-400-0H-20P-ML
	500		8041833	ELGA-BS-KF-80-500-0H-20P-ML
	600		8041834	ELGA-BS-KF-80-600-0H-20P-ML
	120	10	100	8041836
200			8041837	ELGA-BS-KF-120-200-0H-10P-ML
300			8041838	ELGA-BS-KF-120-300-0H-10P-ML
400			8041839	ELGA-BS-KF-120-400-0H-10P-ML
500			8041840	ELGA-BS-KF-120-500-0H-10P-ML
600			8041841	ELGA-BS-KF-120-600-0H-10P-ML
800			8041842	ELGA-BS-KF-120-800-0H-10P-ML
25			100	8041843
		200	8041844	ELGA-BS-KF-120-200-0H-25P-ML
		300	8041845	ELGA-BS-KF-120-300-0H-25P-ML
		400	8041846	ELGA-BS-KF-120-400-0H-25P-ML
		500	8041847	ELGA-BS-KF-120-500-0H-25P-ML
		600	8041848	ELGA-BS-KF-120-600-0H-25P-ML
800		8041849	ELGA-BS-KF-120-800-0H-25P-ML	

## Ordering data – Modular product system

### Orientation guide

- O top
- U bottom
- R right
- L left
- V front
- H rear

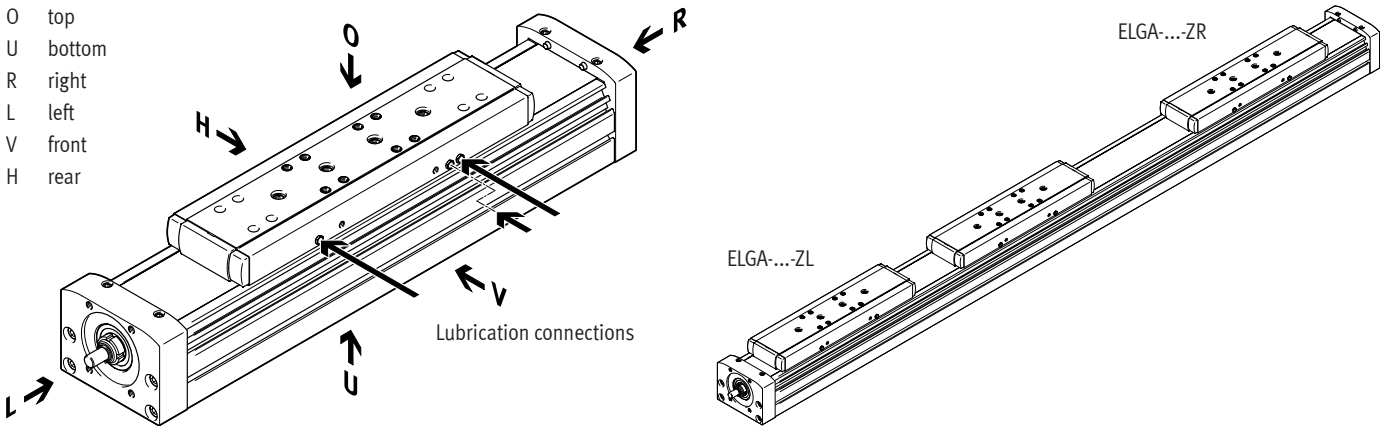

### Accessories

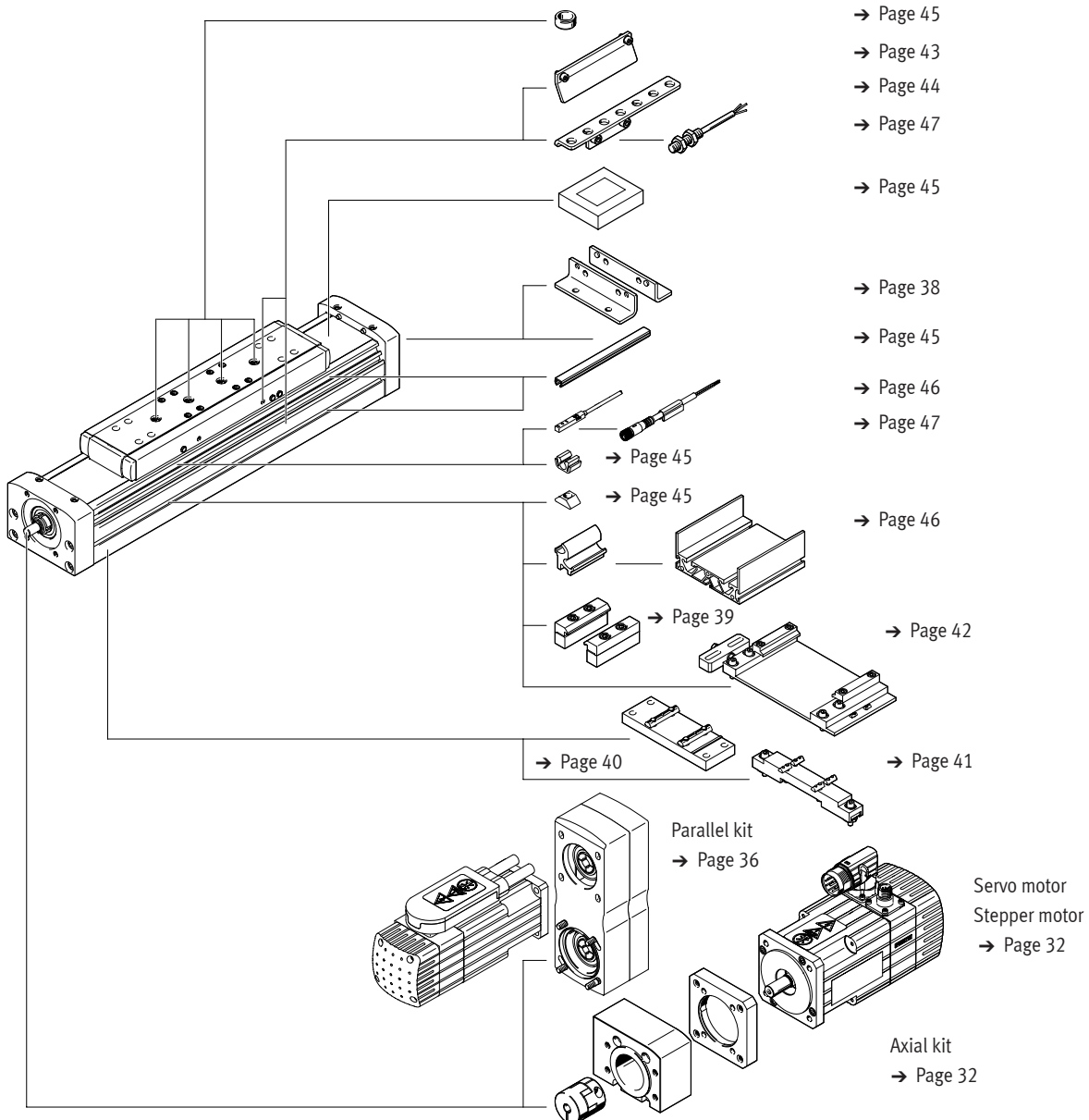

## Ordering data – Modular product system

Ordering table		70	80	120	150	Condi- tions	Code	Enter code
Size								
Module no.		<b>8024918</b>	<b>8024919</b>	<b>8024920</b>	<b>8024921</b>			
Design		Linear axis					<b>ELGA</b>	ELGA
Function		Ball screw					<b>-BS</b>	-BS
Guide		Recirculating ball bearing guide					<b>-KF</b>	-KF
Size	[mm]	70	80	120	150		<b>---</b>	
Stroke length (without stroke reserve)	Standard [mm]	100, 200, 300, 400, 500, 600, 700, 900	100, 200, 300, 400, 500, 600, 700, 800, 900, 1300, 1440, 1740, 1940	100, 200, 300, 400, 500, 600, 700, 800, 900, 1300, 1400, 1960, 2460	200, 400, 500, 900, 1400, 1900, 2500, 3000			
	Variable [mm]	50 ... 880	50 ... 1920	50 ... 2440	50 ... 2980		<b>---</b>	
Stroke reserve	[mm]	0 ... 999 (0 = no stroke reserve)				[1]	<b>---H</b>	
Spindle pitch		10	10	10	–		<b>-10P</b>	
		–	20	–	–		<b>-20P</b>	
		–	–	25	–		<b>-25P</b>	
		–	–	–	40		<b>-40P</b>	
Motor attachment position		Left					<b>-ML</b>	
		Right					<b>-MR</b>	
Additional slide		Without						
		1 slide on left					<b>-ZL</b>	
		1 slide on right					<b>-ZR</b>	
Protection against particles		Standard						
		Cover strip with magnetic deflection					<b>P11</b>	
Displacement encoder, incremental		Without						
		Resolution 2.5 µm					<b>-M1</b>	
		Resolution 10 µm					<b>-M2</b>	
Displacement encoder attachment position		Without						
		Rear				[2]	<b>B</b>	
		Front				[2]	<b>F</b>	

[1] ... H The sum of nominal stroke and 2x stroke reserve must not exceed the maximum stroke length

[2] B, F Only with displacement encoder M1, M2

## Accessories

 **Note**

Depending on the combination of motor and drive, it may not be possible to reach the maximum feed force of the drive.

When using parallel kits, the no-load driving torque of the particular kit must be taken into consideration.

**Permissible axis/motor combinations with axial kit**

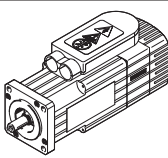
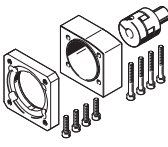
Motor/gear unit <sup>1)</sup>	Axial kit		Data sheets → Internet: eamm-a
			• Kits for third-party motors → Internet: eamm-a
Type	Part no.	Type	
<b>ELGA-BS-...-70</b>			
<b>With servo motor</b>			
EMME-AS-40-...	3637972	EAMM-A-S38-40P-G2	
EMMT-AS-60-..., EMME-AS-60-...	3637958	EAMM-A-S38-60P-G2	
<b>With servo motor and gear unit</b>			
EMME-AS-40-... EMGA-40-P-G-...-EAS-40	1456647	EAMM-A-S38-40G-G2	
<b>With stepper motor</b>			
EMMS-ST-42-...	3637965	EAMM-A-S38-42A-G2	
EMMS-ST-57-...	3637956	EAMM-A-S38-57A-G2	
<b>With stepper motor and gear unit</b>			
EMMS-ST-42-... EMGA-40-P-G-...-SST-42	1456647	EAMM-A-S38-40G-G2	
<b>With integrated drive</b>			
EMCA-EC-67-...	1456638	EAMM-A-S38-67A-G2	
<b>With integrated drive and gear unit</b>			
EMCA-EC-67-... EMGC-40-...	1456647	EAMM-A-S38-40G-G2	
<b>ELGA-BS-...-80</b>			
<b>With servo motor</b>			
EMMT-AS-60-..., EMME-AS-60-...	3637964	EAMM-A-S48-60P-G2	
<b>With servo motor and gear unit</b>			
EMME-AS-40-... EMGA-40-P-G-...-EAS-40	1456650	EAMM-A-S48-40G-G2	
EMMT-AS-60-..., EMME-AS-60-... EMGA-60-P-G-...-EAS-60	1456652	EAMM-A-S48-60H-G2	
<b>With stepper motor</b>			
EMMS-ST-57-...	3637963	EAMM-A-S48-57A-G2	
EMMS-ST-87-...	3637962	EAMM-A-S48-87A-G2	
<b>With stepper motor and gear unit</b>			
EMMS-ST-42-... EMGA-40-P-G-...-SST-42	1456650	EAMM-A-S48-40G-G2	
EMMS-ST-57-... EMGA-60-P-G-...-SST-57	2256701	EAMM-A-S48-60G-G2	
<b>With integrated drive and gear unit</b>			
EMCA-EC-67-... EMGC-40	1456650	EAMM-A-S48-40G-G2	
EMCA-EC-67-... EMGC-60-...	1456652	EAMM-A-S48-60H-G2	

1) The input torque must not exceed the max. permissible transferable torque of the axial kit.



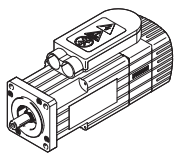
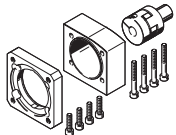

## Accessories

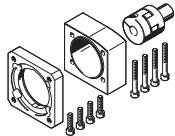
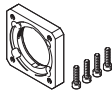
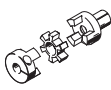

Permissible axis/motor combinations with axial kit		
Motor/gear unit <sup>1)</sup>	Axial kit	
		Data sheets → Internet: eamm-a
		• Kits for third-party motors → Internet: eamm-a
Type	Part no.	Type
<b>ELGA-BS-...-120</b>		
<b>With servo motor</b>		
EMMT-AS-80-..., EMME-AS-80-...	3637970	EAMM-A-S62-80P-G2
EMMT-AS-100-..., EMME-AS-100-...	3637960	EAMM-A-S62-100A-G2
EMMT-AS-150-...	8157272	EAMM-A-S62-150A-G2
<b>With servo motor and gear unit</b>		
EMMT-AS-60-..., EMME-AS-60-...	1456654	EAMM-A-S62-60H-G2
EMGA-60-P-G...-EAS-60		
EMMT-AS-80-..., EMME-AS-80-...	1972530	EAMM-A-S62-80G-G2
EMGA-80-P-G...-EAS-80		
EMMT-AS-100-..., EMME-AS-100-...	1972530	EAMM-A-S62-80G-G2
EMGA-80-P-G...-SAS-100		
<b>With stepper motor</b>		
EMMS-ST-87-...	3637966	EAMM-A-S62-87A-G2
<b>With stepper motor and gear unit</b>		
EMMS-ST-57-...	2297649	EAMM-A-S62-60G-G2
EMGA-60-P-G...-SST-57		
EMMS-ST-87-...	1972530	EAMM-A-S62-80G-G2
EMGA-80-P-G...-SST-87		
<b>With integrated drive and gear unit</b>		
EMCA-EC-67-...	1456654	EAMM-A-S62-60H-G2
EMGC-60-...		
<b>ELGA-BS-...-150</b>		
<b>With servo motor</b>		
EMMT-AS-100-..., EMME-AS-100-...	3637955	EAMM-A-S95-100A-G2
EMMT-AS-150-...	8157279	EAMM-A-S95-150A-G2

1) The input torque must not exceed the max. permissible transferable torque of the axial kit.

## Accessories

Individual components of the axial kit				
Axial kit	Comprising:			
	Motor flange	Coupling	Coupling housing	Screw kit
				
Part no. Type	Part no. Type	Part no. Type	Part no. Type	Part no. Type
<b>ELGA-BS-....-70</b>				
3637971 EAMM-A-S38-40A-G2	558175 EAMF-A-38B-40A	558312 EAMC-30-32-6-6	3637942 EAMK-A-S38-38A/B-G2	-
1456647 EAMM-A-S38-40G-G2	1460097 EAMF-A-38A-40G	562681 EAMC-30-32-6-10	3637942 EAMK-A-S38-38A/B-G2	567488 EAHM-L2-M5-50
3637972 EAMM-A-S38-40P-G2	2219077 EAMF-A-38B-40P	533708 EAMC-30-32-6-8	3637942 EAMK-A-S38-38A/B-G2	-
3637965 EAMM-A-S38-42A-G2	560691 EAMF-A-38B-42A	561333 EAMC-30-32-5-6	3637942 EAMK-A-S38-38A/B-G2	-
3637967 EAMM-A-S38-55A-G2	558176 EAMF-A-38A-55A	551003 EAMC-30-32-6-9	3637942 EAMK-A-S38-38A/B-G2	567488 EAHM-L2-M5-50
3637956 EAMM-A-S38-57A-G2	560692 EAMF-A-38A-57A	551002 EAMC-30-32-6-6.35	3637942 EAMK-A-S38-38A/B-G2	567488 EAHM-L2-M5-50
3637958 EAMM-A-S38-60P-G2	1987412 EAMF-A-38A-60P	1233256 EAMC-30-32-6-14	3637942 EAMK-A-S38-38A/B-G2	567489 EAHM-L2-M5-55
1456638 EAMM-A-S38-67A-G2	1490100 EAMF-A-38A-67A	551003 EAMC-30-32-6-9	3637942 EAMK-A-S38-38A/B-G2	567489 EAHM-L2-M5-55
<b>ELGA-BS-....-80</b>				
1456650 EAMM-A-S48-40G-G2	4067069 EAMF-A-48B-40G	558029 EAMC-30-32-8-10	3637941 EAMK-A-S48-48A/B-G2	-
3637961 EAMM-A-S48-55A-G2	558177 EAMF-A-48B-55A	543423 EAMC-30-32-8-9	3637941 EAMK-A-S48-48A/B-G2	-
3637963 EAMM-A-S48-57A-G2	560694 EAMF-A-48B-57A	543421 EAMC-30-32-6.35-8	3637941 EAMK-A-S48-48A/B-G2	-
2256701 EAMM-A-S48-60G-G2	558019 EAMF-A-48A-60G/H	551004 EAMC-30-32-8-11	3637941 EAMK-A-S48-48A/B-G2	567489 EAHM-L2-M5-55
1456652 EAMM-A-S48-60H-G2	558019 EAMF-A-48A-60G/H	562682 EAMC-30-32-8-14	3637941 EAMK-A-S48-48A/B-G2	567489 EAHM-L2-M5-55
3637964 EAMM-A-S48-60P-G2	2220620 EAMF-A-48A-60P	562682 EAMC-30-32-8-14	3637941 EAMK-A-S48-48A/B-G2	567489 EAHM-L2-M5-55
3637957 EAMM-A-S48-70A-G2	558025 EAMF-A-48A-70A	551004 EAMC-30-32-8-11	3637941 EAMK-A-S48-48A/B-G2	567488 EAHM-L2-M5-50
3637962 EAMM-A-S48-87A-G2	560695 EAMF-A-48A-87A	551004 EAMC-30-32-8-11	3637941 EAMK-A-S48-48A/B-G2	567489 EAHM-L2-M5-55

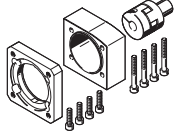
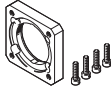
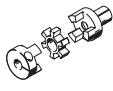
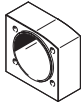
## Accessories

Individual components of the axial kit				
Axial kit	Comprising:			
	Motor flange	Coupling Kits for third-party motors → Internet: eamm-a	Coupling housing	Screw kit
				
Part no. Type	Part no. Type	Part no. Type	Part no. Type	Part no. Type
<b>ELGA-BS-....-120</b>				
2297649 EAMM-A-S62-60G-G2	1460112 EAMF-A-62A-60G/H	525864 EAMC-40-66-11-12	3637940 EAMK-A-S62-62A/B-G2	567495 EAHM-L2-M6-90
1456654 EAMM-A-S62-60H-G2	1460112 EAMF-A-62A-60G/H	1452803 EAMC-40-66-12-14	3637940 EAMK-A-S62-62A/B-G2	567495 EAHM-L2-M6-90
3637959 EAMM-A-S62-70A-G2	558179 EAMF-A-62B-70A	558313 EAMC-42-66-11-12	3637940 EAMK-A-S62-62A/B-G2	–
1972530 EAMM-A-S62-80G-G2	2116672 EAMF-A-62B-80G	2138701 EAMC-42-50-12-20	3637940 EAMK-A-S62-62A/B-G2	–
3637970 EAMM-A-S62-80P-G2	2222624 EAMF-A-62B-80P	551005 EAMC-42-50-12-19	3637940 EAMK-A-S62-62A/B-G2	–
3637966 EAMM-A-S62-87A-G2	560696 EAMF-A-62B-87A	558313 EAMC-42-66-11-12	3637940 EAMK-A-S62-62A/B-G2	–
3637960 EAMM-A-S62-100A-G2	558026 EAMF-A-62A-100A	551005 EAMC-42-50-12-19	3637940 EAMK-A-S62-62A/B-G2	567494 EAHM-L2-M6-80
3637969 EAMM-A-S62-140A-G2	558022 EAMF-A-62A-140A	558314 EAMC-42-50-12-24	3637940 EAMK-A-S62-62A/B-G2	567495 EAHM-L2-M6-90
<b>ELGA-BS-....-150</b>				
3637955 EAMM-A-S95-100A-G2	558182 EAMF-A-95B-100A	558315 EAMC-56-58-19-25	3637939 EAMK-A-S95-95A/B-G2	–
3637954 EAMM-A-S95-140A-G2	558023 EAMF-A-95A-140A	558316 EAMC-56-58-24-25	3637939 EAMK-A-S95-95A/B-G2	567498 EAHM-L2-M8-100

 **Note**

For the optimum selection of axis/  
motor combinations

→ Engineering software  
Electric Motion Sizing  
[www.festo.com/x/electric-motion-sizing](http://www.festo.com/x/electric-motion-sizing)

## Accessories

Data sheets → Internet: eamm-u

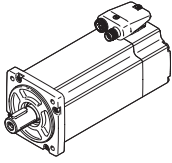
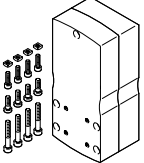
Permissible axis/motor combinations with parallel kit		
Motor/gear unit <sup>1)</sup>	Parallel kit	
		<ul style="list-style-type: none"> <li>The kit can be mounted in all directions</li> <li>To support the axis shaft, a counter bearing EAMG and a clamping sleeve EAMH-...-P with integrated trunnion are included in the scope of delivery for the parallel kit. Additional information → eamm-u</li> <li>Kits for third-party motors → Internet: eamm-u</li> </ul>
Type	Part no.	Type
<b>ELGA-BS-KF-70</b>		
<b>With servo motor</b>		
EMME-AS-40-...	2155239	EAMM-U-50-S38-40P-78
EMMS-AS-55-...	1218538	EAMM-U-60-S38-55A-91
<b>With stepper motor</b>		
EMMS-ST-42-...	1217945	EAMM-U-50-S38-42A-78
EMMS-ST-57-...	1218568	EAMM-U-60-S38-57A-91
<b>Servo motor with gear unit</b>		
EMME-AS-40-...	2283732	EAMM-U-60-S38-40G-91
EMGA-40-P-...		
<b>Stepper motor with gear unit</b>		
EMMS-ST-42-...	2283732	EAMM-U-60-S38-40G-91
EMGA-40-P-...		
<b>With integrated drive and gear unit</b>		
EMCA-EC-67-...	2283732	EAMM-U-60-S38-40G-91
EMGC-40-P-...		
<b>ELGA-BS-KF-80</b>		
<b>With servo motor</b>		
EMMT-AS-60-..., EMME-AS-60-...	2629253	EAMM-U-70-S48-60P-96
<b>With stepper motor</b>		
EMMS-ST-57-...	1219379	EAMM-U-60-S48-57A-91
EMMS-ST-87-...	1217604	EAMM-U-86-S48-87A-177
<b>Servo motor with gear unit</b>		
EMME-AS-40-...	2283760	EAMM-U-60-S48-40G-91
EMGA-40-P-...		
EMMT-AS-60-..., EMME-AS-60-...	2801715	EAMM-U-70-S48-60H-96
EMGA-60-P-...-EAS <sup>2)</sup>	1587338	EAMM-U-86-S48-60H-102
<b>Stepper motor with gear unit</b>		
EMMS-ST-57-...	2801627	EAMM-U-70-S48-60G-96
EMGA-60-P-...-SST <sup>2)</sup>	1587251	EAMM-U-86-S48-60G-102
<b>With integrated drive and gear unit</b>		
EMCA-EC-67-...	2283760	EAMM-U-60-S48-40G-91
EMGC-40-P-...		
EMCA-EC-67-...	2801715	EAMM-U-70-S48-60H-96
EMGC-60-P-... <sup>2)</sup>	1587338	EAMM-U-86-S48-60H-102

1) The input torque must not exceed the max. permissible transferable torque of the parallel kit.

2) Gear unit output shaft diameter: EMGA-60-P-...-SAS/SST: 11 mm; EMGA-60-P-...-EAS, EMGC-60-P: 14 mm

## Accessories

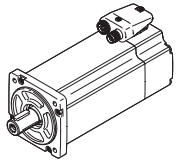
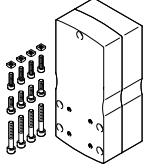
Permissible axis/motor combinations with parallel kit		Data sheets → Internet: eamm-u	
Motor/gear unit <sup>1)</sup>	Parallel kit		
			
	<ul style="list-style-type: none"> <li>The kit can be mounted in all directions</li> <li>To support the axis shaft, a counter bearing EAMG and a clamping sleeve EAMH-...-P with integrated trunnion are included in the scope of delivery for the parallel kit. Additional information → eamm-u</li> <li>Kits for third-party motors → Internet: eamm-u</li> </ul>		
Type	Part no.	Type	
<b>ELGA-BS-KF-120</b>			
<b>With servo motor</b>			
EMMT-AS-80-..., EMME-AS-80-...	2157004	EAMM-U-86-S62-80P-177	
EMMT-AS-100-..., EMME-AS-100-...	1217381	EAMM-U-110-S62-100A-207	
EMMT-AS-150-...	8157287	EAMM-U-145-S62-150A-288	
<b>With stepper motor</b>			
EMMS-ST-87-...	1217373	EAMM-U-86-S62-87A-177	
<b>Servo motor with gear unit</b>			
EMMT-AS-60-..., EMME-AS-60-... EMGA-60-P-...-EAS <sup>2)</sup>	1587453	EAMM-U-86-S62-60H-177	
<b>Stepper motor with gear unit</b>			
EMMS-ST-57-... EMGA-60-P-...-SST <sup>2)</sup>	1587411	EAMM-U-86-S62-60G-177	
<b>With integrated drive and gear unit</b>			
EMCA-EC-67-... EMGC-60-P-... <sup>2)</sup>	1587453	EAMM-U-86-S62-60H-177	
<b>ELGA-BS-KF-150</b>			
<b>With servo motor</b>			
EMMT-AS-100-..., EMME-AS-100-...	1220656	EAMM-U-110-S95-100A-207	
<b>Servo motor with gear unit</b>			
EMMT-AS-80-..., EMMT-AS-100-... EMME-AS-80-..., EMME-AS-100-... EMGA-80-P-...	1589544	EAMM-U-110-S95-80G-207	
<b>Stepper motor with gear unit</b>			
EMMS-ST-87-... EMGA-80-P-...	1589544	EAMM-U-110-S95-80G-207	

1) The input torque must not exceed the max. permissible transferable torque of the parallel kit.

2) Gear unit output shaft diameter: EMGA-60-P-...SAS/SST: 11 mm; EMGA-60-P-...EAS, EMGC-60-P: 14 mm

**Note**

The clamping element EADT is required to adjust the toothed belt pretensioning for EAMM-U-110 and EAMM-U-145.

## Accessories

### Foot mounting HPE

Material:

Galvanised steel

RoHS-compliant

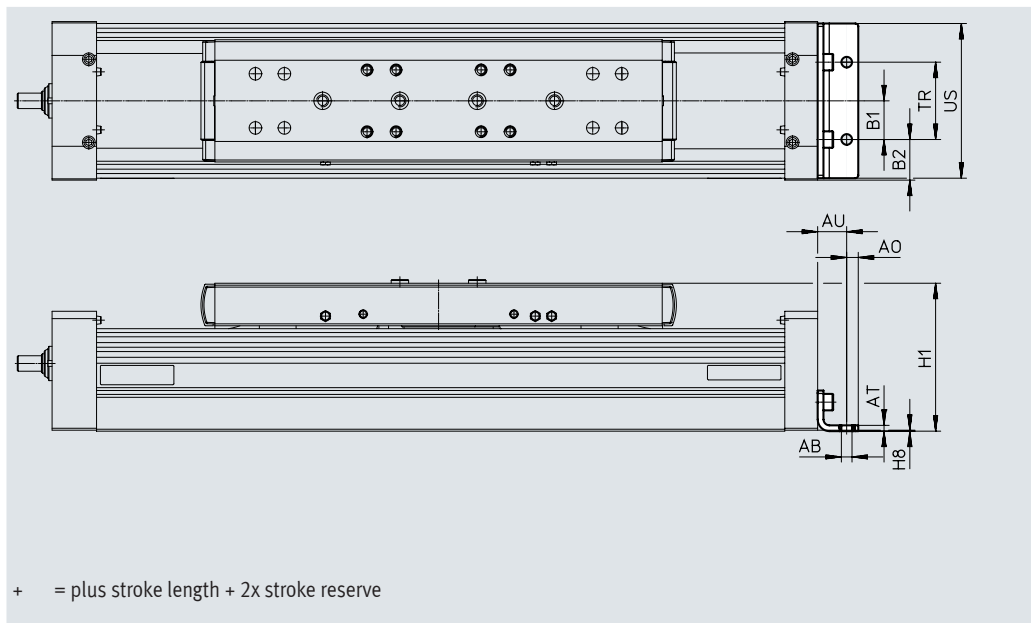

#### Dimensions and ordering data

For size	AB ∅	A0	AT	AU	B1	B2	H1	H8
70	5.5	6	3	13	20	14.5	64	0.5
80	5.5	6	3	15	20	21	76.5	0.5
120	9	8	6	22	40	20	111.5	1
150	9	12	8	25	40	35	141.5	1

For size	TR	US	Weight [g]	Part no.	Type
70	40	67	115	558321	HPE-70
80	40	80	150	558322	HPE-80
120	80	116	578	558323	HPE-120
150	80	150	1181	3002636	HPE-150

## Accessories

### Profile mounting MUE

Material:  
Anodised aluminium  
RoHS-compliant

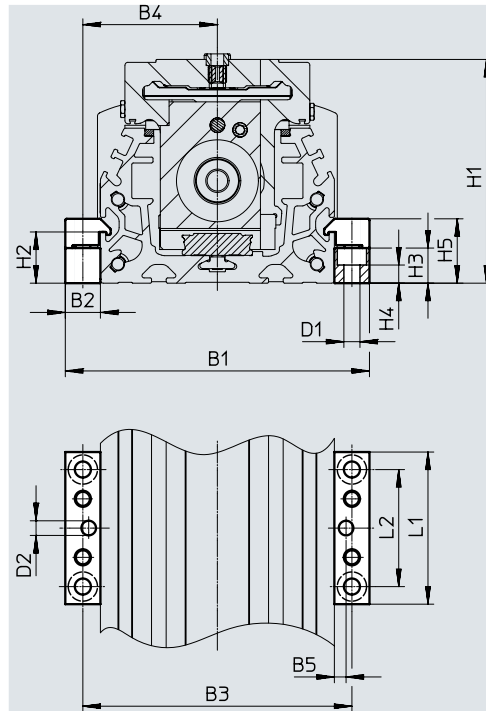

#### Dimensions and ordering data

For size	B1	B2	B3	B4	B5	D1 ∅	D2 ∅ H7	H1	H2
70	91	12	79	39.5	4	5.5	5	64	17.5
80	104	12	92	46	4	5.5	5	76.5	17.5
120	154	19	135	67.5	4	9	5	111.5	16
150	188	19	169	84.5	4	9	5	141.5	16

For size	H3	H4	H5	L1	L2	Weight [g]	Part no.	Type
70	12	6.2	22	52	40	80	558043	MUE-70/80
80	12	6.2	22	52	40	80	558043	MUE-70/80
120	14	5.5	29.5	90	40	290	558044	MUE-120/185
150	14	5.5	29.5	90	40	290	558044	MUE-120/185

## Accessories

### Central support EAHF

Material:  
Anodised aluminium  
RoHS-compliant

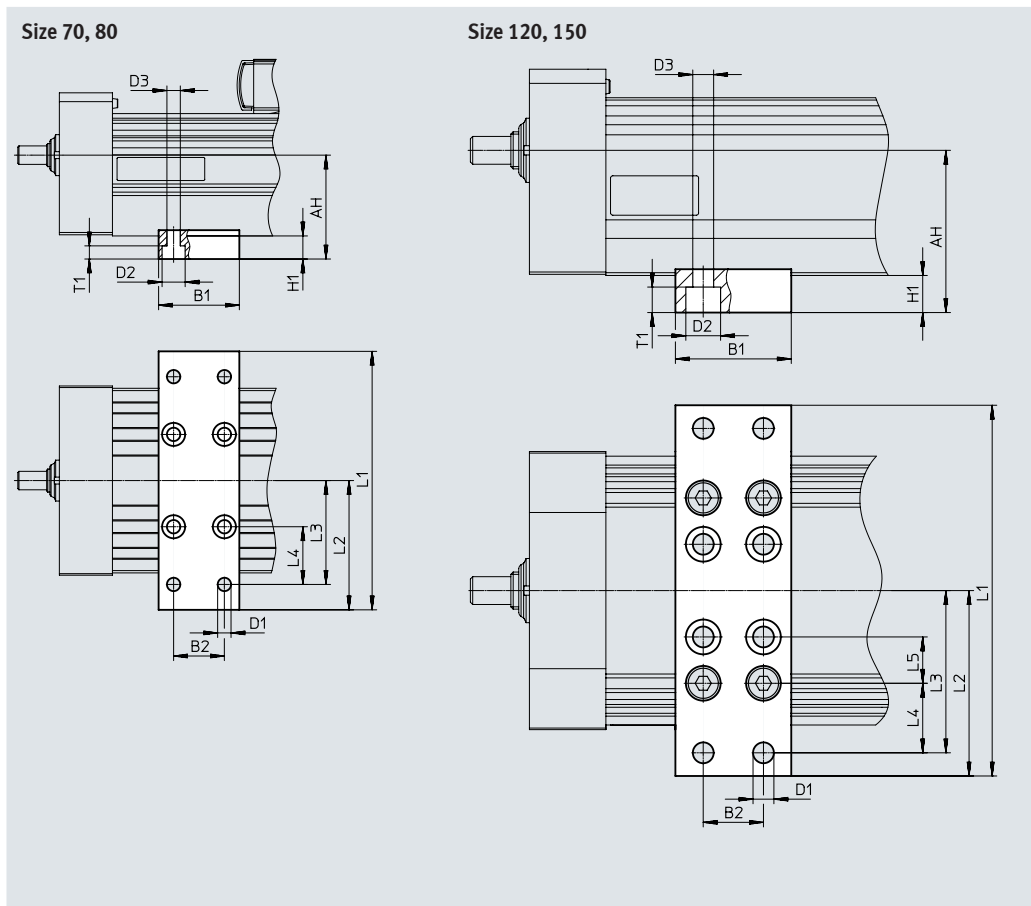

#### Dimensions and ordering data

For size	AH	B1	B2	D1 ∅	D2 ∅	D3 ∅	H1	L1
70	38.5	35	22	5.8	10	5.8	10	102
80	45							112
120	70	50	26	9	15	9	16	160
150	88.5							200

For size	L2	L3	L4	L5	T1	Weight [g]	Part no.	Type
70	51	45	25	–	5.7	113	2349256	EAHF-L5-70-P
80	62	50		–		123	3535188	EAHF-L5-80-P
120	80	70	30	20	11	384	2410274	EAHF-L5-120-P
150	100	90				50	–	495



## Accessories

### Adjusting kit EADC-E15

Material:

EADC-E15-80: wrought aluminium alloy

EADC-E15-185: steel

RoHS-compliant

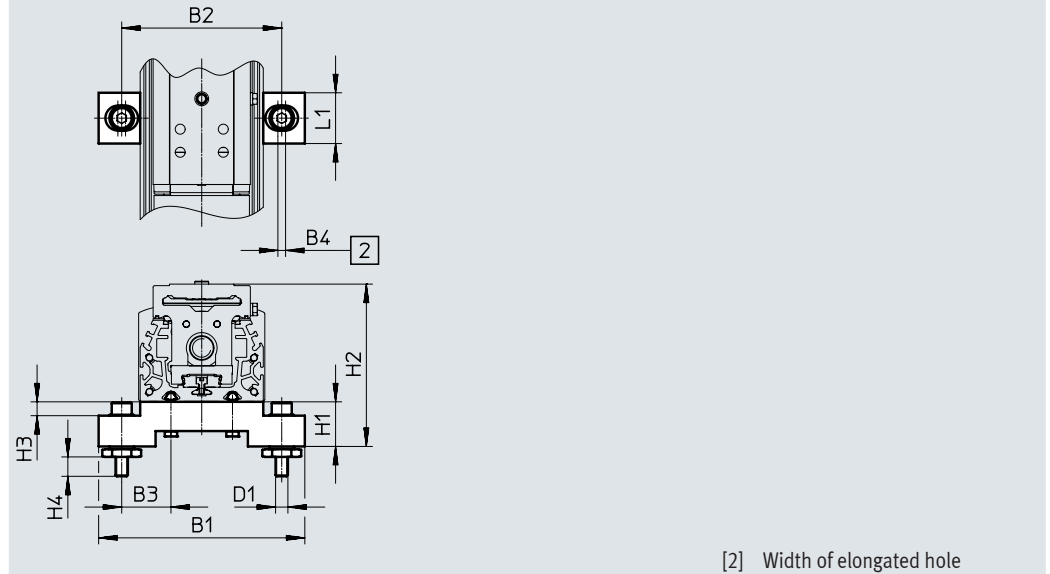
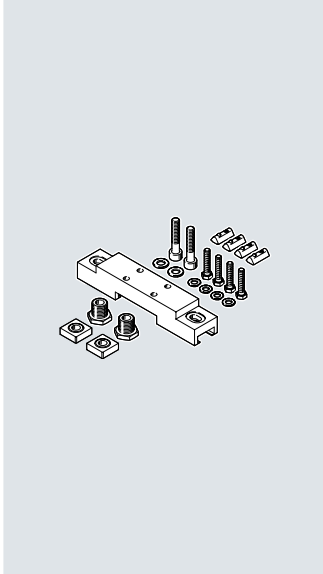

[2] Width of elongated hole

#### Dimensions and ordering data

For size	B1	B2	B3	B4	D1	H1
70	134	104	32	5	M8	29
80	134	104	32	5	M8	29
120	236	209	64.5	5	M8	29
150	236	209	64.5	5	M8	29

For size	H2	H3	H4	L1	Weight [g]	Part no.	Type
70	93	9	12.6	33	386	8047566	EADC-E15-80-E7
80	105.5	9	12.6	33	386	8047566	EADC-E15-80-E7
120	140.5	9	12.6	33	569	8047568	EADC-E15-185-E7
150	170.5	9	12.6	33	569	8047568	EADC-E15-185-E7

## Accessories

### Adjusting kit EADC-E16

Material:  
Wrought aluminium alloy  
RoHS-compliant

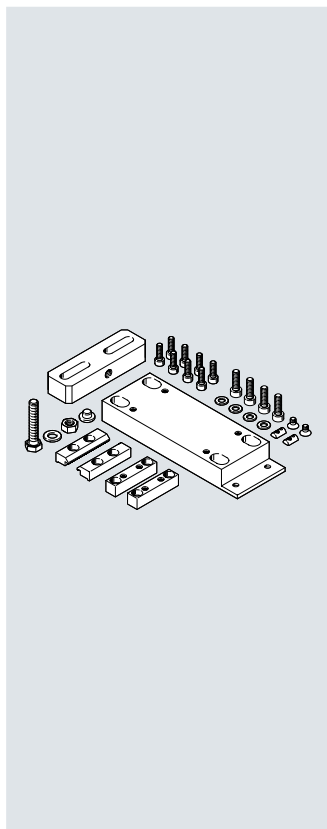

Size 80

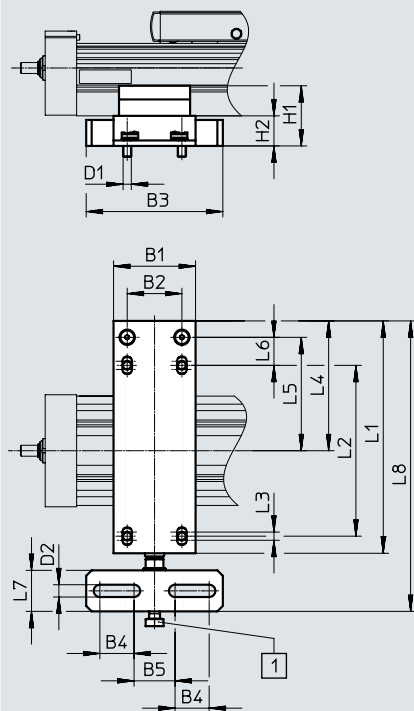

Size 120

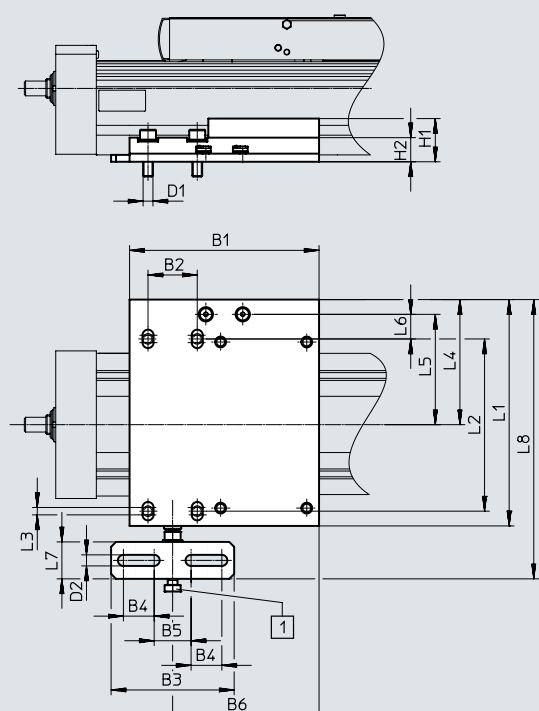

[1] M8 screw

#### Dimensions and ordering data

For size	B1	B2	B3	B4	B5	B6	D1	D2	H1	H2	L1	L2
80	60	40	100	25	30	–	M6	9	44	22	170	125
120	154	40	100	25	30	119	M8	9	35.1	19.6	184	140

For size	L3	L4	L5	L6	L7	L8	Weight [g]	Part no.	Type
80	6	95	83	20.5	30	212.5	828	8047577	EADC-E16-80-E7
120	6	101.7	89.7	20	30	227	1134	8047578	EADC-E16-120-E7

## Accessories

### Switch lug SF-EGC-1

Material:  
Galvanised steel  
RoHS-compliant

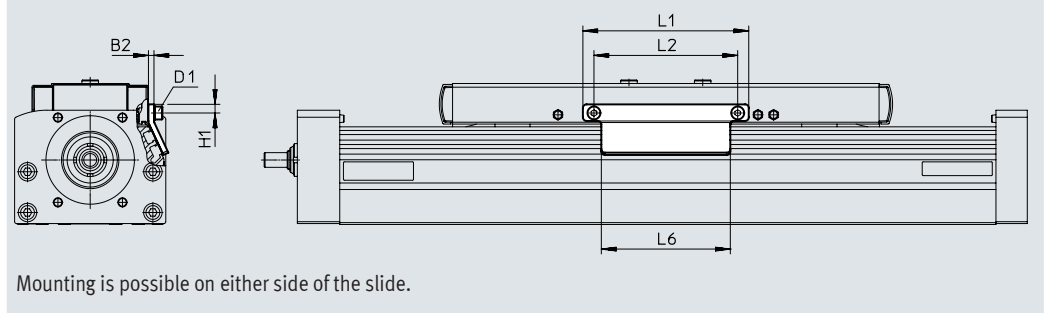
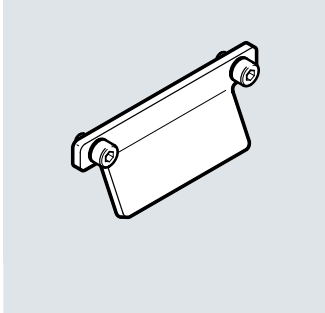

#### Dimensions and ordering data

For size	B2	D1	H1	L1	L2	L6	Weight [g]	Part no.	Type
70	3	M4	4.65	70	56	50	50	558047	SF-EGC-1-70
80	3	M4	4.65	90	78	70	63	558048	SF-EGC-1-80
120	3	M5	8	170	140	170	147	558049	SF-EGC-1-120
150	3	M5	10	230	200	230	246	558051	SF-EGC-1-185

## Accessories

### Switch lug SF-EGC-2

for sensing with proximity sensor  
SIEN-M8B or SIES-8M

Material:  
Galvanised steel  
RoHS-compliant

Switch lug SF-EGC-2

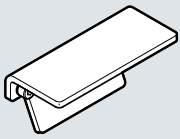

### Sensor bracket HWS-EGC

for proximity sensor SIEN-M8B

Material:  
Galvanised steel  
RoHS-compliant

Sensor bracket HWS-EGC

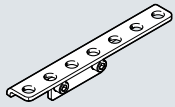

#### Size 70, 80, 120

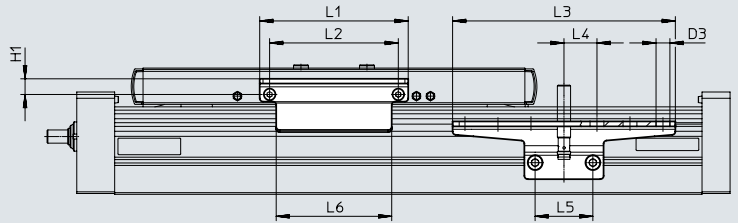
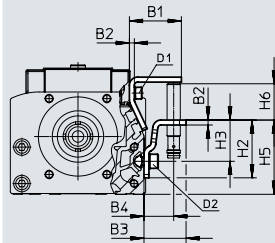

#### Size 150

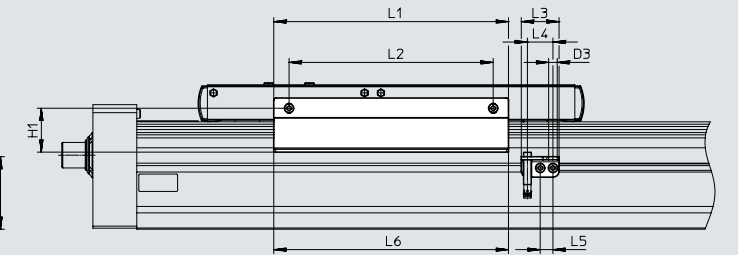
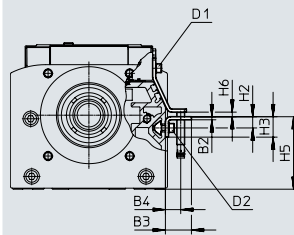

Mounting is possible on either side of the slide.

#### Dimensions and ordering data





For size	B1	B2	B3	B4	D1	D2	D3 ∅	H1	H2
70	31.5	3	25.5	18	M4	M5	8.4	9.5	35
80	31.5	3	25.5	18	M4	M5	8.4	9.5	35
120	32	3	25.5	18	M5	M5	8.4	13.2	65
150	33	3	25.5	15	M5	M5	8.4	43	20

For size	H3	H5	H6 max.	L1	L2	L3	L4	L5	L6
70	25	45	13.5	70	56	135	20	35	50
80	25	45	23.5	90	78	135	20	35	70
120	55	75	24	170	140	215	20	35	170
150	11	71	4.5	230	200	37	25	12.5	230

For size	Weight [g]	Part no.	Type
Switch lug			
70	100	558052	SF-EGC-2-70
80	130	558053	SF-EGC-2-80
120	277	558054	SF-EGC-2-120
150	390	558056	SF-EGC-2-185

For size	Weight [g]	Part no.	Type
Sensor bracket			
70	110	558057	HWS-EGC-M5
80	110	558057	HWS-EGC-M5
120	217	570365	HWS-EGC-M8-B
150	58	560517	HWS-EGC-M8: KURZ (SHORT)

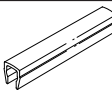
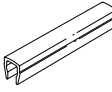
## Accessories

Ordering data					
	For size	Description	Part no.	Type	PJ <sup>1)</sup>
<b>Slot nut NST</b>					
	70, 80	For mounting slot	150914	NST-5-M5	1
			8047843	NST-5-M5-10	10
			8047878	NST-5-M5-50	50
	120, 150	For mounting slot	150915	NST-8-M6	1
			8047868	NST-8-M6-10	10
			8047869	NST-8-M6-50	50
<b>Centring pin/sleeve ZBS/ZBH</b>					
	70	For slide	150928	ZBS-5	10
	70, 80, 120, 150		8137184	ZBH-9-B	
<b>Slot cover ABP</b>					
	70, 80	<ul style="list-style-type: none"> <li>For mounting slot</li> <li>Each 0.5 m</li> </ul>	151681	ABP-5	2
	120, 150		151682	ABP-8	
<b>Slot cover ABP-S</b>					
	70 ... 150	<ul style="list-style-type: none"> <li>For sensor slot</li> <li>Each 0.5 m</li> </ul>	563360	ABP-5-S1	2
<b>Clip SMBK</b>					
	70 ... 150	For sensor slot, for mounting the proximity sensor cables	534254	SMBK-8	10
<b>Clamping element EADT</b>					
	70, 80	Tool for retensioning the cover strip	8058451	EADT-S-L5-70	1
	120, 150		8058450	EADT-S-L5-120	

1) Packaging unit

## Accessories

### Mounting options between axis and support profile

Depending on the adapter kit, the spacing between the axis and the support profile is:  
 $x = 20 \text{ mm}$  or  $50 \text{ mm}$

The support profile must be mounted using at least 2 adapter kits. For longer strokes, an adapter kit must be used every 500 mm.

Example

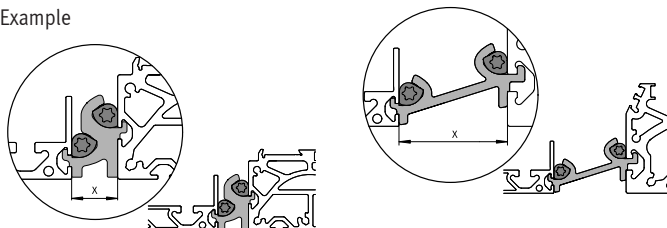

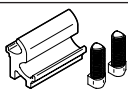
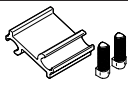
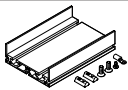



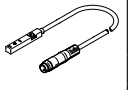
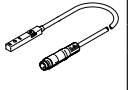

Ordering data			Part no.	Type	PU <sup>1)</sup>
For size	Description				
<b>Adapter kit DHAM</b>					
	80	<ul style="list-style-type: none"> <li>For mounting the support profile on the axis</li> <li>Spacing between axis and profile is 20 mm</li> </ul>	562241	DHAM-ME-N1-CL	1
	120, 150		562242	DHAM-ME-N2-CL	
	70, 80	<ul style="list-style-type: none"> <li>For mounting the support profile on the axis</li> <li>Spacing between axis and profile is 50 mm</li> </ul>	574560	DHAM-ME-N1-50-CL	
	120, 150		574561	DHAM-ME-N2-50-CL	
<b>Support profile HMIA</b>					
	70 ... 150	<ul style="list-style-type: none"> <li>For guiding an energy chain</li> </ul>	539379	HMIA-E07-	1

1) Packaging unit

Ordering data – Proximity sensors for T-slot, inductive						Data sheets → Internet: sies
Type of mounting	Electrical connection	Switching output	Cable length [m]	Part no.	Type	
<b>N/O contact</b>						
	Insertable in the slot from above, flush with the cylinder profile	Cable, 3-wire	PNP	7.5	551386	SIES-8M-PS-24V-K-7.5-OE
		Plug M8x1, 3-pin		0.3	551387	SIES-8M-PS-24V-K-0.3-M8D
		Cable, 3-wire	NPN	7.5	551396	SIES-8M-NS-24V-K-7.5-OE
		Plug M8x1, 3-pin		0.3	551397	SIES-8M-NS-24V-K-0.3-M8D
<b>N/C contact</b>						
	Insertable in the slot from above, flush with the cylinder profile	Cable, 3-wire	PNP	7.5	551391	SIES-8M-PO-24V-K-7.5-OE
		Plug M8x1, 3-pin		0.3	551392	SIES-8M-PO-24V-K-0.3-M8D
		Cable, 3-wire	NPN	7.5	551401	SIES-8M-NO-24V-K-7.5-OE
		Plug M8x1, 3-pin		0.3	551402	SIES-8M-NO-24V-K-0.3-M8D

## Accessories

Ordering data – Proximity sensors M8 (round design), inductive						Data sheets → Internet: sien
	Electrical connection	LED	Switching output	Cable length [m]	Part no.	Type
<b>N/O contact</b>						
	Cable, 3-wire	■	PNP	2.5	150386	SIEN-M8B-PS-K-L
			NPN	2.5	150384	SIEN-M8B-NS-K-L
	Plug M8x1, 3-pin	■	PNP	–	150387	SIEN-M8B-PS-S-L
			NPN	–	150385	SIEN-M8B-NS-S-L
<b>N/C contact</b>						
	Cable, 3-wire	■	PNP	2.5	150390	SIEN-M8B-PO-K-L
			NPN	2.5	150388	SIEN-M8B-NO-K-L
	Plug M8x1, 3-pin	■	PNP	–	150391	SIEN-M8B-PO-S-L
			NPN	–	150389	SIEN-M8B-NO-S-L

Ordering data – Connecting cables					Data sheets → Internet: nebu
	Electrical connection, left	Electrical connection, right	Cable length [m]	Part no.	Type
	Straight socket, M8x1, 3-pin	Cable, open end, 3-wire	2.5	159420	SIM-M8-3GD-2.5-PU
			2.5	541333	NEBU-M8G3-K-2.5-LE3
			5	541334	NEBU-M8G3-K-5-LE3
	Angled socket, M8x1, 3-pin	Cable, open end, 3-wire	2.5	541338	NEBU-M8W3-K-2.5-LE3
			5	541341	NEBU-M8W3-K-5-LE3

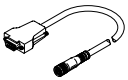
Ordering data – Encoder cables for displacement encoder, ELGA-...-M1/-M2					Data sheets → Internet: nebm
	Electrical connection, left	Electrical connection, right	Cable length [m]	Part no.	Type
	Displacement encoder ELGA-...-M1/-M2	Motor controller CMMP-AS and CMMT-AS	5	1599105	NEBM-M12G8-E-5-S1G9-V3
			10	1599106	NEBM-M12G8-E-10-S1G9-V3
			15	1599107	NEBM-M12G8-E-15-S1G9-V3
			χ <sup>1)</sup>	1599108	NEBM-M12G8-E-...-S1G9-V3

1) Max. cable length 25 m.

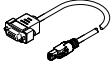
Ordering data – Adapter			
	Description	Part no.	Type
	Required in combination with the servo drive CMMT-AS as adapter between encoder cable NEBM-M12G8-...-V3 and interface X3 (position encoder 2)	8106112	NEFM-S1G9-K-0.5-R3G8